

DESCRIPTION

The MP9186 is a synchronous, rectified, step-down, switch-mode converter with internal power MOSFETs. It offers a very compact solution to achieve a 6A continuous output current over a wide input supply range with excellent load and line regulation. The MP9186 has synchronous mode operation for higher efficiency over the output current load range.

Current-mode operation provides a fast transient response and eases loop stabilization. Full protection features include over-current protection and thermal shutdown.

The MP9186 requires a minimal number of readily-available standard external components and is available in a space saving 3mm×3mm 14-pin QFN package.

FEATURES

- Wide 4.5V-to-20V Operating Input Range
- 6A Output Current
- Low $R_{DS(ON)}$ Internal Power MOSFETs
- Programmable Switching Frequency
- Programmable EN Delay
- Frequency SYNC from 300kHz to 2MHz External Clock
- Low Power Mode Selectable by an External Signal
- External Soft Start
- OCP and Thermal Shutdown
- Available in a 14-pin 3x3mm QFN Package

APPLICATIONS

- DSL Modems
- Cable Modems
- Set-top Boxes

All MPS parts are lead-free and adhere to the RoHS directive. For MPS green status, please visit MPS website under Products, Quality Assurance page.

"MPS" and "The Future of Analog IC Technology" are Registered Trademarks of Monolithic Power Systems, Inc.

TYPICAL APPLICATION

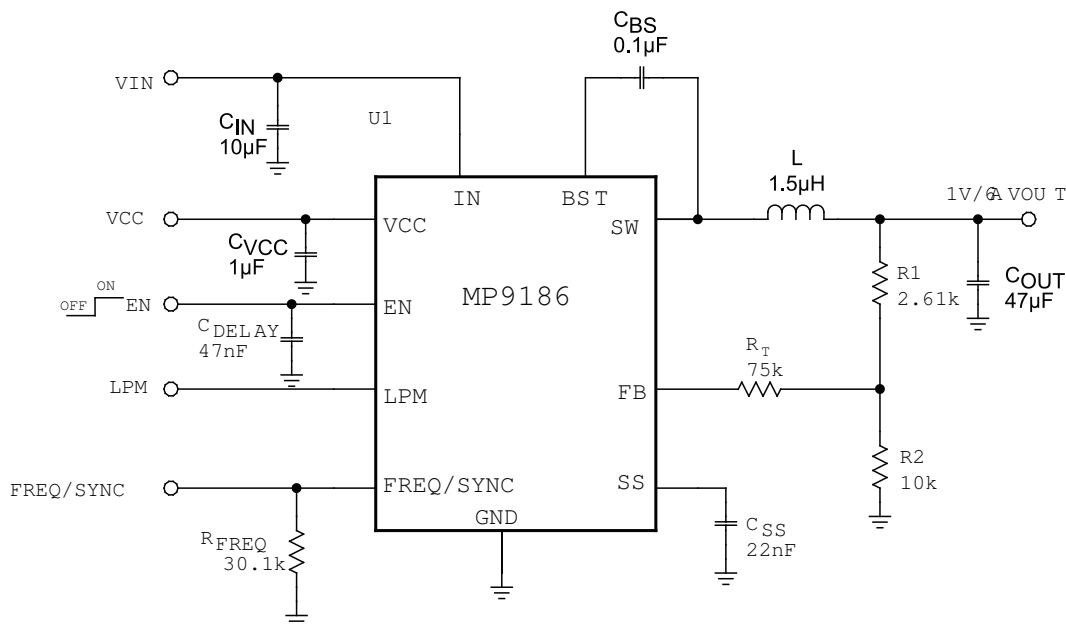

ORDERING INFORMATION

| Part Number | Package | Top Marking |
|-------------|---------------|-------------|
| MP9186GQ* | QFN14 (3×3mm) | AEK |

* For Tape & Reel, add suffix -Z (eg. MP9186GQ-Z);

PACKAGE REFERENCE

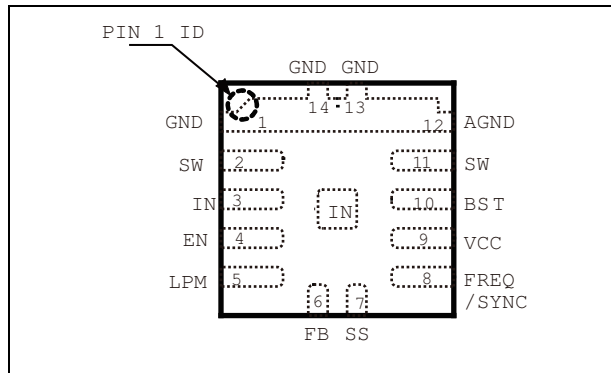

ABSOLUTE MAXIMUM RATINGS ⁽¹⁾

| | |
|---|--|
| V_{IN} | -0.3V to 22V |
| V_{SW} | -0.3V (-5V for <10ns) to 23V (25V for <10ns) |
| V_{BST} | $V_{SW} + 6V$ |
| All Other Pins..... | -0.3V to 6V ⁽²⁾ |
| Lead Temperature | 260°C |
| Continuous Power Dissipation ($T_A = +25^\circ C$) ⁽³⁾ | |
| 3x3 QFN14 | 2.1W |
| Junction Temperature..... | 150°C |

Recommended Operating Conditions ⁽⁴⁾

| | |
|------------------------------------|------------------------------|
| Supply Voltage V_{IN} | 4.5V to 20V |
| Output Voltage V_{OUT} | 0.8V to $V_{IN} \times 90\%$ |
| Operating Junction Temp. (T_J) | -40°C to +125°C |

| | | |
|--|---------------|---------------|
| Thermal Resistance ⁽⁵⁾ | θ_{JA} | θ_{JC} |
| QFN14 (3x3mm) | 60 | 12... °C/W |

Notes:

- 1) Exceeding these ratings may damage the device.
- 2) Please refer to page 9, Enable Control section, For absolute maximum rating of EN pin.
- 3) The maximum allowable power dissipation is a function of the maximum junction temperature T_J (MAX), the junction-to-ambient thermal resistance θ_{JA} , and the ambient temperature T_A . The maximum allowable continuous power dissipation at any ambient temperature is calculated by P_D (MAX) = $(T_J$ (MAX)- T_A)/ θ_{JA} . Exceeding the maximum allowable power dissipation will cause excessive die temperature, and the regulator will go into thermal shutdown. Internal thermal shutdown circuitry protects the device from permanent damage.
- 4) The device is not guaranteed to function outside of its operating conditions.
- 5) Measured on JESD51-7, 4-layer PCB.

ELECTRICAL CHARACTERISTICS

$V_{IN} = 12V$, $T_A = 25^{\circ}C$, unless otherwise noted.

| Parameters | Symbol | Condition | Min | Typ | Max | Units |
|---|---------------|--------------------------------------|------|------|------|-------------|
| Supply Current (Shutdown) | I_{IN} | $V_{EN} = 0V$ | | 10 | 15 | μA |
| Supply Current (Quiescent) | I_Q | $V_{EN} = 2V$, $V_{FB} = 1V$ | | 0.8 | 1.2 | mA |
| HS Switch-On Resistance | HS_{RDS-ON} | | | 60 | | m Ω |
| LS Switch-On Resistance | LS_{RDS-ON} | | | 30 | | m Ω |
| Switch Leakage | SW_{LKG} | $V_{EN} = 0V$, $V_{SW} = 0V$ or 12V | | 0 | 1 | μA |
| Current Limit ⁽⁶⁾ | I_{LIMIT} | Duty=40% | 7.4 | 9.4 | | A |
| Oscillator Frequency | f_{SW} | $R_{SET}=30k$ | 400 | 500 | 600 | kHz |
| Maximum Duty Cycle | D_{MAX} | $V_{FB} = 700mV$, $R_{SET}=30k$ | 90 | 95 | | % |
| Minimum On Time ⁽⁶⁾ | T_{ON_MIN} | | | 40 | | ns |
| Sync Frequency Range | f_{SYNC} | | 0.3 | | 2 | MHz |
| Feedback Voltage | V_{FB} | | 782 | 798 | 814 | mV |
| Feedback Current | I_{FB} | $V_{FB} = 800mV$ | | 25 | 50 | nA |
| EN Input Low Voltage | V_{ILEN} | | 0.98 | 1.12 | 1.32 | V |
| EN Input High Voltage | V_{IHEN} | | 1.32 | 1.50 | 1.78 | V |
| EN Pin Pull-Up Current | I_{EN} | | 1.2 | 2.3 | 3.5 | μA |
| V_{IN} Under-Voltage Lockout Threshold Rising | $INUV_{Vth}$ | | 3.75 | 4 | 4.25 | V |
| V_{IN} Under-Voltage Lockout Threshold Hysteresis | $INUV_{HYS}$ | | | 820 | | mV |
| VCC Regulator | V_{CC} | | | 5 | | V |
| VCC Load Regulation | | $I_{CC}=5mA$ | | 1 | | % |
| Thermal Shutdown ⁽⁶⁾ | T_{SD} | | | 150 | | $^{\circ}C$ |
| Thermal Shutdown Hysteresis ⁽⁶⁾ | T_{SD-HYS} | | | 30 | | $^{\circ}C$ |
| Soft Start Current | I_{SS} | | 5 | 8 | 11 | μA |

Note:

6) Guaranteed by design

PIN FUNCTIONS

| QFN 3×3mm Pin # | Name | Description |
|--------------------|---------------|--|
| 1, 13, 14 | GND | Ground. Connect these pins with larger copper areas to the negative terminals of the input and output capacitors. |
| 2, 11 | SW | Switch Output. Use wide PCB traces to make the connection. |
| 3, 15 (IN) | IN | Supply Voltage. The MP9186 operates from a 4.5V-to-20V input rail. Requires C1 to decouple the input rail. Use wide PCB traces and multiple vias to make the connection. |
| 4 | EN | Enable. EN=1 to enable the MP9186. The EN pin sources 2.3μA current. Place a capacitor from EN to GND for delayed start-up. |
| 5 | LPM | Low-Power Mode Input. An active-high signal enables low-power mode operation. Connect LPM pin to GND to disable it and make the converter always operate in CCM. |
| 6 | FB | Feedback. Connect to the tap of an external resistor divider from the output to GND to set the output voltage. |
| 7 | SS | Soft Start. Connect an external capacitor to program the soft-start time for the switch-mode regulator. |
| 8 | FREQ/ SYNC | Switching Frequency Program Input. Connect a resistor from this pin to GND to set the switching frequency. This pin also serves as a frequency-synchronous clock input. |
| 9 | VCC | Bias Supply. Decouple with 1μF capacitor. Decouple capacitor must be close enough to VCC pin to increase noise immunity. |
| 10 | BST | Bootstrap. Requires a capacitor connected between SW and BST pins to form a floating supply across the high-side switch driver. |
| 12 | AGND | Analog ground for internal control circuit. |

TYPICAL CHARACTERISTICS

$V_{IN} = 12V$, $V_{OUT} = 1V$, $L = 1.5\mu H$, $f_s = 500kHz$, $T_A = +25^\circ C$, unless otherwise noted.

Enabled Supply Current vs. Input Voltage

$V_{IN} = 6-20V$, $I_{OUT} = 0A$

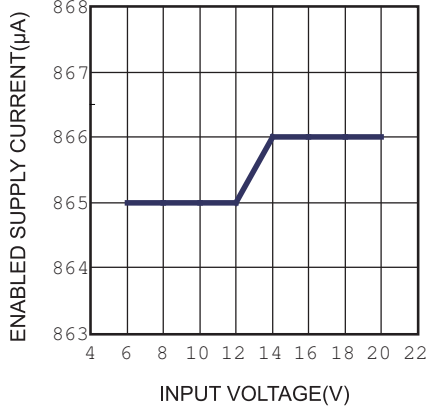

Disabled Supply Current vs. Input Voltage

$V_{IN} = 6-20V$, $I_{OUT} = 0A$

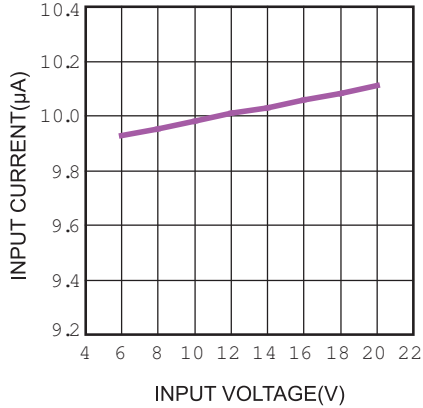

Typical V_{FB} vs. Temperature

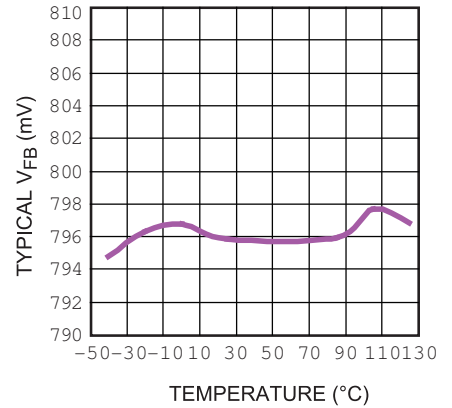

Load Regulation

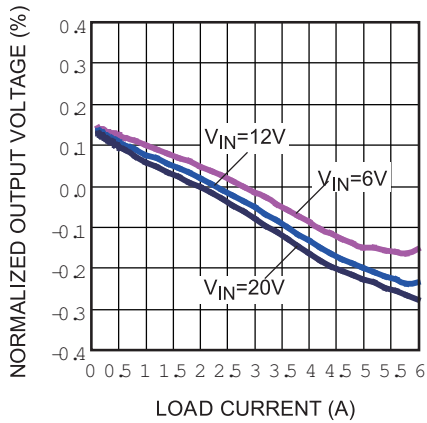

Line Regulation

$V_{IN} = 5V-20V$

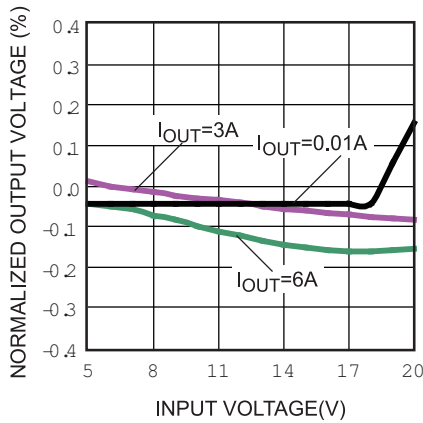

Peak Current vs. Duty Cycle

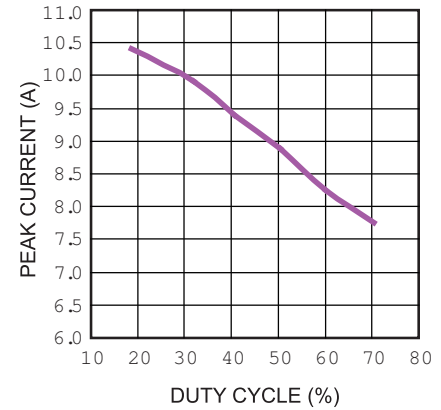

TYPICAL PERFORMANCE CHARACTERISTICS (continued)
 $V_{IN} = 12V$, $V_{OUT} = 1V$, $L = 1.5\mu H$, $f_s = 500kHz$, $T_A = +25^\circ C$, unless otherwise noted.

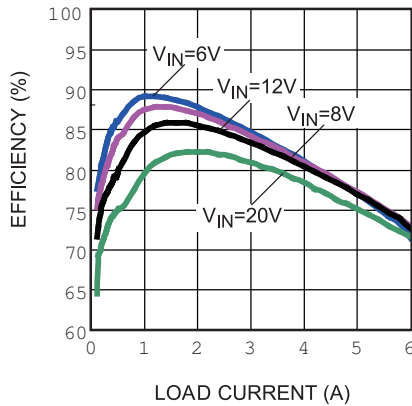
Efficiency vs. Load Current

Case Temperature Rise vs. Output Current
 $V_{IN} = 12V$, $I_{OUT} = 1A-6A$, 4 Layers PCB,

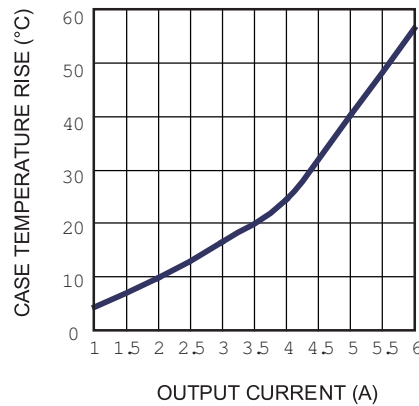
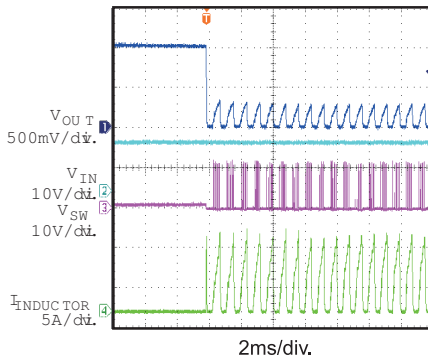
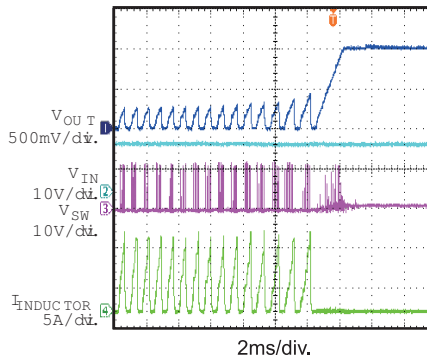
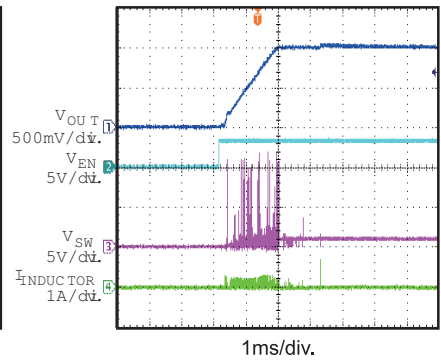
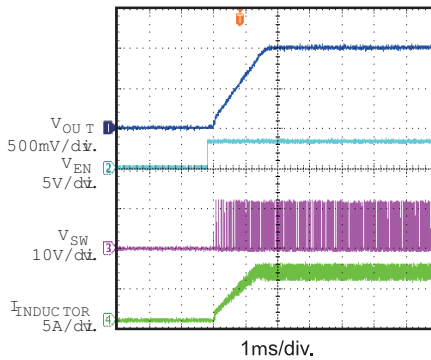
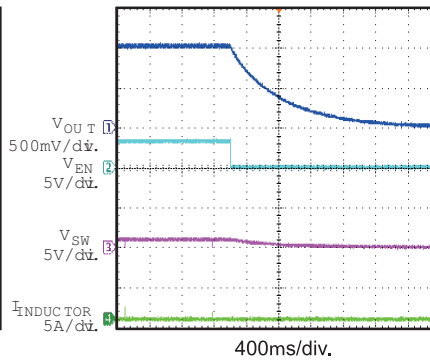
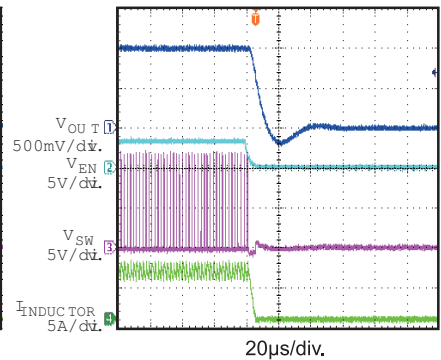
Size: 6.35cm x 6.35cm

Short Entry
 $I_{OUT} = 0A$

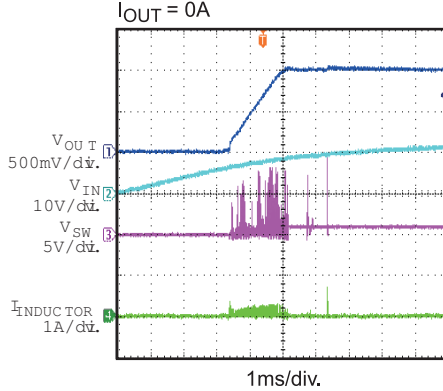
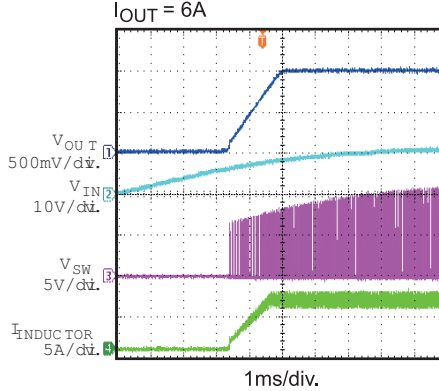
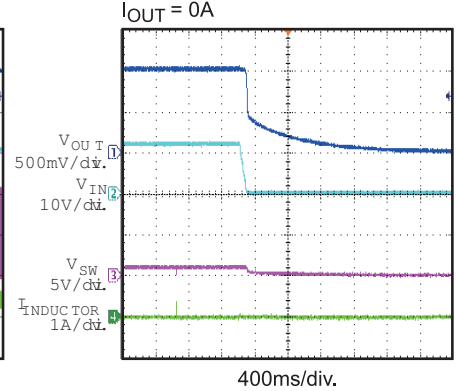
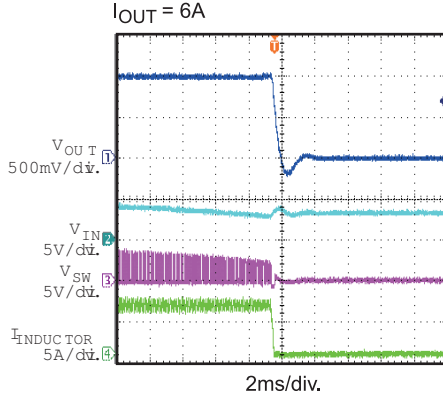
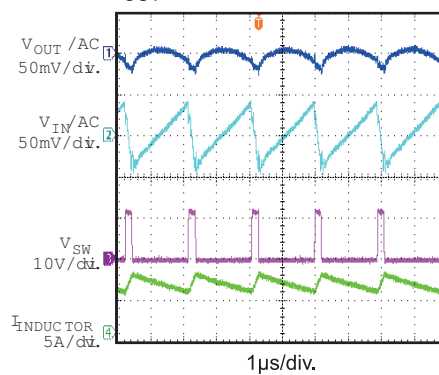
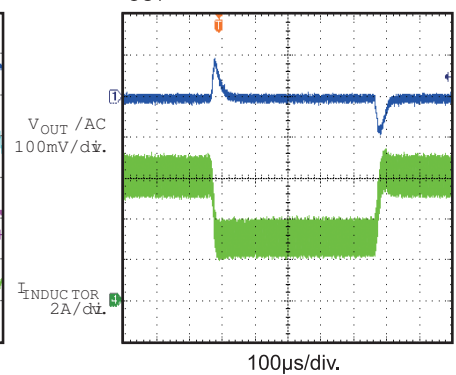
Short Recovery
 $I_{OUT} = 0A$

Startup Through Enable
 $I_{OUT} = 0A$

Startup Through Enable
 $I_{OUT} = 6A$

Shutdown Through Enable
 $I_{OUT} = 0A$

Shutdown Through Enable
 $I_{OUT} = 6A$

TYPICAL PERFORMANCE CHARACTERISTICS (continued)
 $V_{IN}=12V, V_{OUT}=1V, L = 1.5\mu H, f_s=500kHz, T_A = +25^{\circ}C$, unless otherwise noted.

Startup Through Input Voltage
 $I_{OUT} = 0A$

Startup Through Input Voltage
 $I_{OUT} = 6A$

Shutdown Through Input Voltage
 $I_{OUT} = 0A$

Shutdown Through Input Voltage
 $I_{OUT} = 6A$

Input / Output Ripple
 $I_{OUT} = 6A$

Load Transient Reponse
 $I_{OUT} = 3A - 6A$

FUNCTIONAL BLOCK DIAGRAM

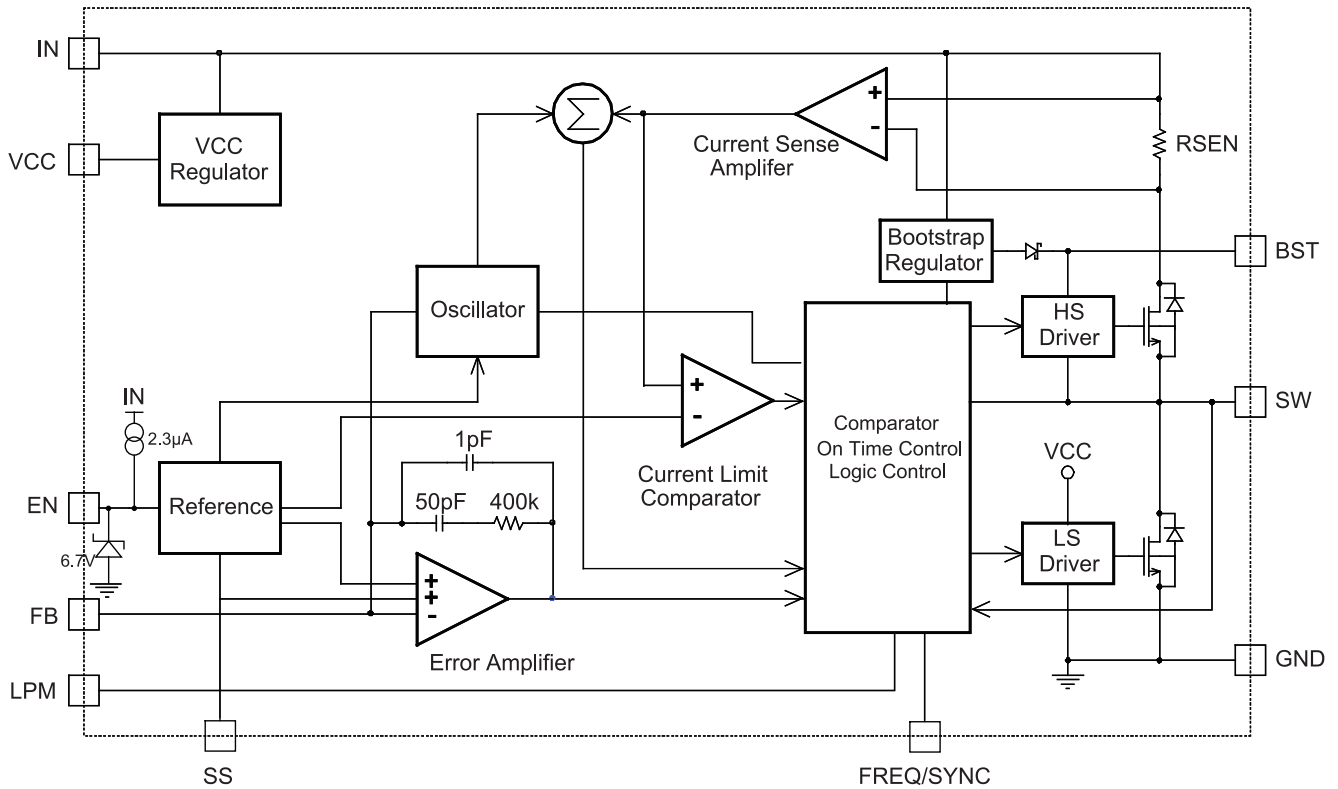

Figure 1: Functional Block Diagram

OPERATION

The MP9186 is a high-frequency, synchronous, rectified, step-down, switch-mode converter with internal power MOSFETs. It offers a very compact solution to achieve 6A of continuous output current over a wide input supply range with excellent load and line regulation.

The MP9186 operates in a fixed-frequency, peak-current-mode control to regulate the output voltage. The internal clock initiates the PWM cycle, turning on the integrated high-side power MOSFET. The high-side MOSFET remains on until its current reaches the value set by the COMP voltage. When the power switch is off, it remains off until the next clock cycle starts. If, within 90% of one PWM period, the current in the power MOSFET does not reach the COMP set current value, the power MOSFET will be forced to turn off.

Error Amplifier

The error amplifier compares the FB pin voltage against the internal 0.8V reference (REF) and outputs a current proportional to the difference between the two. This output current charges or discharges the internal compensation network to form the COMP voltage, which controls the power MOSFET current. The optimized internal compensation network minimizes the external component count and simplifies the control loop design.

Internal Regulator

The 5V internal regulator powers most of the internal circuitries. This regulator takes the VIN input and operates in the full VIN range. When VIN exceeds 5.0V, the output of the regulator is in full regulation. When VIN is less than 5.0V, the output decreases. The part requires a 1μF ceramic decoupling capacitor.

Enable Control

The MP9186 has a dedicated enable control pin (EN): pulling it high or floating it enables the IC, pulling it low disables it. EN must be pulled low to disable the part.

The EN pin is clamped internally using a 6.7V series-Zener-diode as shown in Figure 2. Connect the EN input pin through a pullup

resistor to any voltage connected to the VIN pin such that the pullup resistor limits the EN input current to less than 100μA.

For example, connecting 12V to VIN, $R_{PULLUP} \geq (12V - 6.7V)/100\mu A = 53k\Omega$.

Connecting the EN pin is directly to a voltage source without any pullup resistor requires limiting the amplitude of the voltage source to below 6V to prevent damage to the Zener diode.

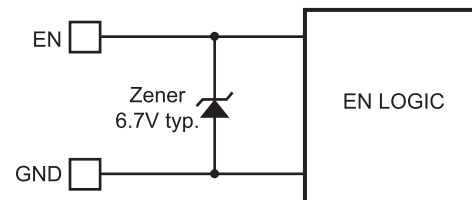

Figure 2: Zener Diode between EN and GND

The EN pin also features an internal 2.3μA current source. Connect a capacitor to the EN pin for delayed startup. When VIN exceeds the input UVLO, an internal 2.3μA current source charges the external capacitor. The external capacitor connects to the non-inverting input of a comparator. The part is enabled once the capacitor voltage exceeds the 1.5V internal reference voltage.

Frequency Synchronizing

The MP9186 can be synchronized to an external clock with a range from 300kHz to 2MHz through the SYNC pin. The internal clock rising edge is synchronized to the external clock rising edge.

Low Power Mode

The MP9186 can operate in discontinuous mode (DCM) and Pulse skip mode (PSM) under light load to improve efficiency, featured as the Low Power Mode. To enable Low Power Mode, connect LPM pin to VCC pin or to a voltage divider from VCC. To disable Low Power Mode, connect LPM pin to ground and the converter will always operate in CCM.

When the LPM pin connects to VCC, the inductor peak current is set internally which is about 1.58A for VIN=12V, VOUT=1V and L=1.5μH. Peak inductor current also can be set

by connecting LPM pin to a voltage divider from VCC with 2 external resistors. By program LPM voltage, efficiency and output ripple can be traded off and optimized. Higher LPM gives higher peak inductor current thus more efficient but more output ripple. The curve of inductor peak current vs. low power mode voltage for $V_{IN}=12V$, $V_{OUT}=1V$, $L=1.5\mu H$ is shown in Figure 3.

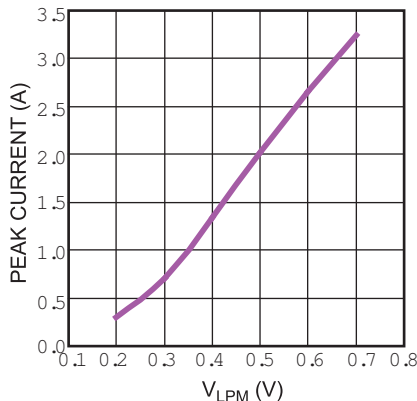

Figure 3: Inductor Peak Current vs. Low Power Mode Voltage

Under-Voltage Lockout (UVLO)

Under-voltage lockout (UVLO) protects the chip from operating at insufficient supply voltage. The MP9186's UVLO comparator monitors the output voltage of the internal regulator, VCC. The UVLO rising threshold is 4V while its falling threshold is 3.18V.

External Soft-Start

Connect a capacitor from the soft-start pin to ground to adjust the soft-start time. When soft-start begins, an internal $8\mu A$ current source charges the external capacitor. The soft-start capacitor connects to the non-inverting input of the error amplifier. The soft-start period lasts until the voltage on the soft-start capacitor exceeds the 0.798V reference. At this point the reference voltage takes over at the non-inverting error-amplifier input. The soft-start time can be calculated as follows:

$$t_{ss}(ms) = \frac{0.798V \times C_{ss}(nF)}{8\mu A}$$

If the output of the MP9186 is pre-biased to a certain voltage during startup, the IC will disable the switching of both high-side and low-side switches until the voltage on the internal soft-

start capacitor exceeds the sensed output voltage at the FB pin.

Over-Current-Protection

The MP9186 has a hiccup mode over-current limit for when the inductor current peak value exceeds the set current limit threshold.

When the output voltage drops below 70% of the reference, and inductor current exceeds the current limit, the MP9186 will enter hiccup mode and retry until the fault is removed. This is especially useful to ensure system safety under fault conditions.

The hiccup function is disabled during soft-start duration.

Thermal Shutdown

Thermal shutdown prevents the chip from operating at exceedingly high temperatures. When the silicon die temperature exceeds $150^{\circ}C$, it shuts down the whole chip. When the temperature falls below its lower threshold, typically $120^{\circ}C$, the chip is enabled again.

Floating Driver and Bootstrap Charging

An external bootstrap capacitor powers the floating power MOSFET driver. This floating driver has its own UVLO protection. The UVLO's rising threshold is 2.2V with a hysteresis of 150mV. The bootstrap capacitor voltage is regulated internally by VIN through D1, M1, R5, C4, L1 and C2 (Figure 4). If $(V_{IN} - V_{SW})$ exceeds 5V, U1 regulates M1 to maintain a 5V BST voltage across C4. A 10Ω resistor placed between SW and BST capacitor is strongly recommended to reduce SW spike voltage and noise.

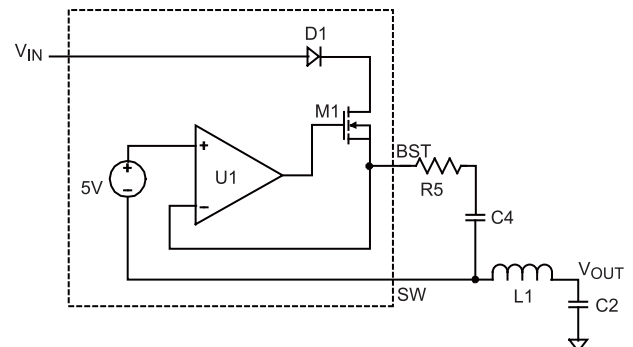

Figure 4: Internal Bootstrap Charging Circuit

Startup and Shutdown

If both VIN and EN exceed their respective thresholds, the chip is enabled. The reference block starts first, generating a stable reference voltage and currents, and then the internal regulator is enabled. The regulator provides a stable supply for the remaining circuitries.

Three events can shut down the chip: EN low, VIN low and thermal shutdown. In shutdown, the signaling path is first blocked to avoid any fault triggering. The COMP voltage and the internal supply rail are then pulled down. The floating driver is not subject to this shutdown command.

APPLICATION INFORMATION

COMPONENT SELECTION

Setting the Output Voltage

The external resistor divider sets the output voltage (see Typical Application on page 1). The feedback resistor, R1, also sets the feedback loop bandwidth with the internal compensation capacitor. Choose R1 around 10kΩ, then R2 is:

$$R2 = \frac{R1}{\frac{V_{OUT}}{0.798V} - 1}$$

The T-type network (shown in Figure 5) is highly recommended when V_{OUT} is low.

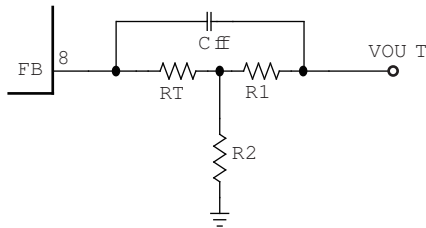

Figure 5: T-Type Network

Table 1 lists the recommended T-type resistors value for common output voltages.

Table 1: Resistor Selection for Common Output Voltages

| V _{OUT} (V) | R1 (kΩ) | R2 (kΩ) | Rt (kΩ) | Cff (pF) |
|----------------------|----------|----------|---------|----------|
| 1 | 2.61(1%) | 10(1%) | 75(1%) | 10 |
| 1.2 | 5.1(1%) | 10(1%) | 75(1%) | 10 |
| 1.8 | 10(1%) | 7.87(1%) | 43(1%) | 10 |
| 2.5 | 10(1%) | 4.64(1%) | 24(1%) | 15 |
| 3.3 | 10(1%) | 3.16(1%) | 10(1%) | 22 |
| 5 | 10(1%) | 1.87(1%) | 10(1%) | 22 |

Selecting the Inductor

Use a 1μH-to-10μH inductor with a DC current rating of at least 25% percent higher than the maximum load current for most applications. Select an inductor with a DC resistance less than 15mΩ for best efficiency. Use the following equation to derive the inductor value for most designs.

$$L_1 = \frac{V_{OUT} \times (V_{IN} - V_{OUT})}{V_{IN} \times \Delta I_L \times f_{OSC}}$$

Where ΔI_L is the inductor ripple current.

Choose the inductor ripple current to be approximately 30% of the maximum load current. The maximum inductor peak current is:

$$I_{L(MAX)} = I_{LOAD} + \frac{\Delta I_L}{2}$$

Under light-load conditions (below 100mA), use a larger inductor for improved efficiency.

Setting the Switching Frequency

An external resistor, R_{FREQ}, from the FREQ pin to GND sets the MP9186's oscillating frequency. The value of R_{FREQ} can be calculated from:

$$R_{FREQ} (k\Omega) = \frac{15000}{f_s (kHz)}$$

Selecting the Input Capacitor

The input current to the step-down converter is discontinuous, and therefore requires a capacitor to supply the AC current to the step-down converter while maintaining the DC input voltage. Use low-ESR capacitors for the best performance. Ceramic capacitors with X5R or X7R dielectrics are highly recommended because of their low ESR and small temperature coefficients. For most applications, a 22μF capacitor is sufficient.

Since the input capacitor (C1) absorbs the input switching current it requires an adequate ripple current rating. The RMS current in the input capacitor can be estimated by:

$$I_{C1} = I_{LOAD} \times \sqrt{\frac{V_{OUT}}{V_{IN}} \times \left(1 - \frac{V_{OUT}}{V_{IN}}\right)}$$

The worse case condition occurs at V_{IN} = 2V_{OUT}, where:

$$I_{C1} = \frac{I_{LOAD}}{2}$$

For simplification, choose the input capacitor whose RMS current rating is greater than half of the maximum load current.

The input capacitor can be electrolytic, tantalum or ceramic. When using electrolytic or tantalum capacitors, place a small, high-quality ceramic capacitor (e.g. 0.1 μ F) as close to the IC as possible. When using ceramic capacitors, make sure that they have enough capacitance to provide sufficient charge to prevent excessive voltage ripple at the input. The input voltage ripple caused by the capacitance can be estimated by:

$$\Delta V_{IN} = \frac{I_{LOAD}}{f_s \times C1} \times \frac{V_{OUT}}{V_{IN}} \times \left(1 - \frac{V_{OUT}}{V_{IN}}\right)$$

Selecting the Output Capacitor

The device requires an output capacitor (C2) to maintain the DC output voltage. Use ceramic, tantalum, or low ESR electrolytic capacitors. Use low-ESR capacitors to limit the output voltage ripple. Estimate the output voltage ripple with:

$$\Delta V_{OUT} = \frac{V_{OUT}}{f_s \times L_1} \times \left(1 - \frac{V_{OUT}}{V_{IN}}\right) \times \left(R_{ESR} + \frac{1}{8 \times f_s \times C2}\right)$$

Where L_1 is the inductor value and R_{ESR} is the equivalent series resistance (ESR) value of the output capacitor.

For ceramic capacitors, the impedance at the switching frequency is dominated by the capacitance. The output voltage ripple is mainly caused by the capacitance. For simplification, the output voltage ripple can be estimated by:

$$\Delta V_{OUT} = \frac{V_{OUT}}{8 \times f_s^2 \times L_1 \times C2} \times \left(1 - \frac{V_{OUT}}{V_{IN}}\right)$$

For tantalum or electrolytic capacitors, the ESR dominates the impedance at the switching frequency. For simplification, the output ripple can be approximated to:

$$\Delta V_{OUT} = \frac{V_{OUT}}{f_s \times L_1} \times \left(1 - \frac{V_{OUT}}{V_{IN}}\right) \times R_{ESR}$$

The characteristics of the output capacitor also affect the stability of the regulatory system. The

MP9186 can be optimized for a wide range of capacitance and ESR values.

External Bootstrap Diode

An external bootstrap diode can enhance the efficiency of the regulator, given the following conditions:

- V_{OUT} is 5V or 3.3V; and
- Duty cycle is high: $D = \frac{V_{OUT}}{V_{IN}} > 65\%$

Use an external BST diode from the VCC pin to the BST pin—as shown in Figure 6—for such cases.

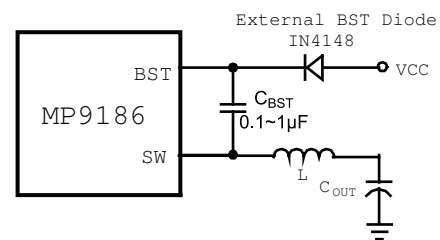

Figure 6: Optional Bootstrap Diode

The recommended external BST diode is IN4148, and the BST capacitor is 0.1 μ F to 1 μ F.

PC Board Layout

This PCB board layout is referring to the schematic in Figure 8.

Place the high-current paths (GND, IN and SW) very close to the device with short, direct and wide traces. The input decoupling capacitor needs to be placed as close as possible to the IN and GND pins. The VCC decoupling capacitor needs to be placed as close as possible to the VCC pin and multiple VIAs should be used on both the ground side of the VCC decoupling capacitor and the GND pins to connect to the inner and bottom ground plane. Place the external feedback resistors next to the FB pin. Keep the switching node SW short and away from the feedback network.

Design Example

Below is a design example following the application guidelines for the specifications:

Table 2: Design Example

| | |
|-----------|-----|
| V_{IN} | 12V |
| V_{OUT} | 1V |
| I_o | 6A |

The detailed application schematic is shown in Figure 8. The typical performance and circuit waveforms have been shown in the Typical Performance Characteristics section. For more device applications, please refer to the related Evaluation Board Datasheets.

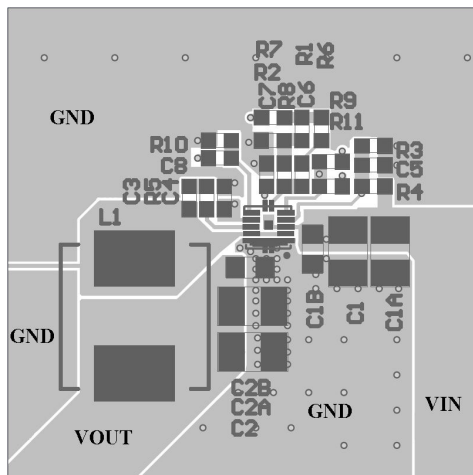

Top Layer

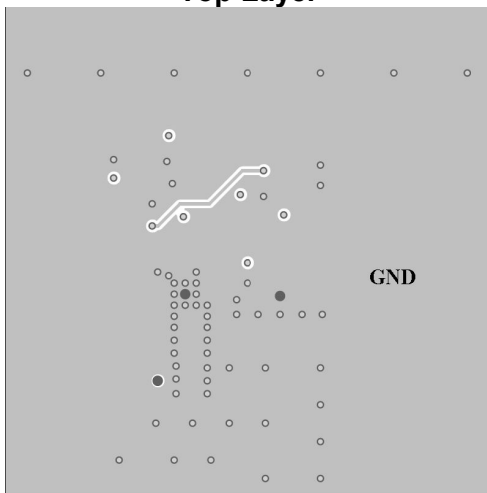

Bottom Layer

Figure 7: PCB Layout

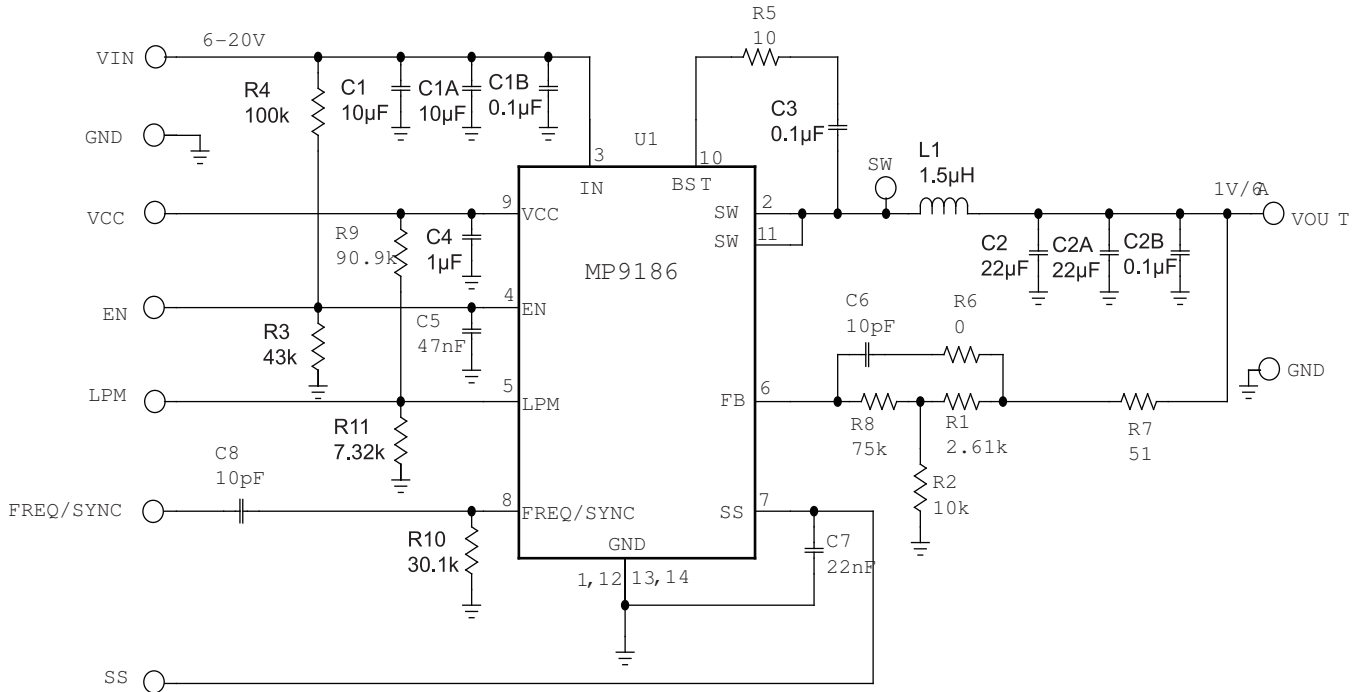
TYPICAL APPLICATION CIRCUITS

Figure 8: 500kHz, 1V Output at 6A Step-Down Converter