

PF5030_SDS

Fail-safe system basis chip with multiple SMPs and LDOs

Rev. 2 — 17 March 2023

Product short data sheet

1 General description

PF5030 is a power management integrated circuit (PMIC) designed for S32Z2/E2 processors. Its input voltage of up to 5.25 V maximum makes it ideal to work in conjunction with NXP front system supply families (FS86, FS6x) or any other front supply in the automotive drive train market.

Built-in One-Time Programmable (OTP) memory stores key start-up configurations, drastically reducing external components typically used to set output voltage and sequence of external regulators. Regulator parameters are adjustable through I²C after start-up, offering flexibility for different system states.

2 Features and benefits

Voltage Range

- 5.25 V DC maximum operating voltage
- Support operating voltage range down to 3.3 V
- Low power OFF mode with low sleep current (15 μ A typical)

Power Supplies

- BUCK1/2: Low voltage integrated synchronous buck converter
 - Configurable output voltage from 0.7 V to 1.5 V and current capability up to 3.5 A DC
 - Capable of multiphase operation for up to 7.0 A DC
- BUCK3: Low voltage integrated synchronous buck converter
 - Configurable output voltage from 1.0 V to 4.1 V and current capability up to 2.5 A DC
- LDO1/2: Low voltage LDO regulator for MCU I/O and system peripheral
 - Configurable Output voltage from 1.1 V to 4.1 V and current capability up to 400 mA DC

System support

- 1x input pin for power-ON detection, 1.8 V, 3.3 V, and 5.0 V compatible
- Analog multiplexer with full system voltages and temperature monitoring
- Enhanced leader / follower power-up sequencing management through XFAILB pin
- 10 ms optional RSTB release delay during power-up for certain MCU compliance
- Device control via 32 bits I²C interface with 8-bit CRC

Compliance

- EMC optimization techniques on switching regulators including spread spectrum and manual frequency tuning
- EMI robustness supporting various automotive EMI test standards
- Conducted emission: IEC 61967-4
- Conducted immunity: IEC 62132-4

Functional Safety

- ASIL D capability on safety goal 1 (SG1/CSG_01) on UV/OV for all S32Z2/E2 power rails (0.8 V, 1.1 V, 1.8 V, and 3.3 V)



- Configurable ASIL from QM to ASIL D on safety goal 2 (SG2/CSG_02) on MCU monitoring function (watchdog)
- Independent voltage monitoring circuitry
- Up to 6 voltage monitoring inputs with 1.0 % target accuracy
- Logical and analog built-in self-test (LBIST/ABIST)
- Safety outputs with latent fault detection mechanism (PGOOD, RSTB, FS0B)

Configuration and enablement

- QFN 40 pins with exposed pad for optimized thermal management
- OTP programming for device customization

3 Applications

- EV propulsion and power train domain controller
- Chassis-integrated systems
- S32Z2/E2 companion chip

4 Simplified application diagram

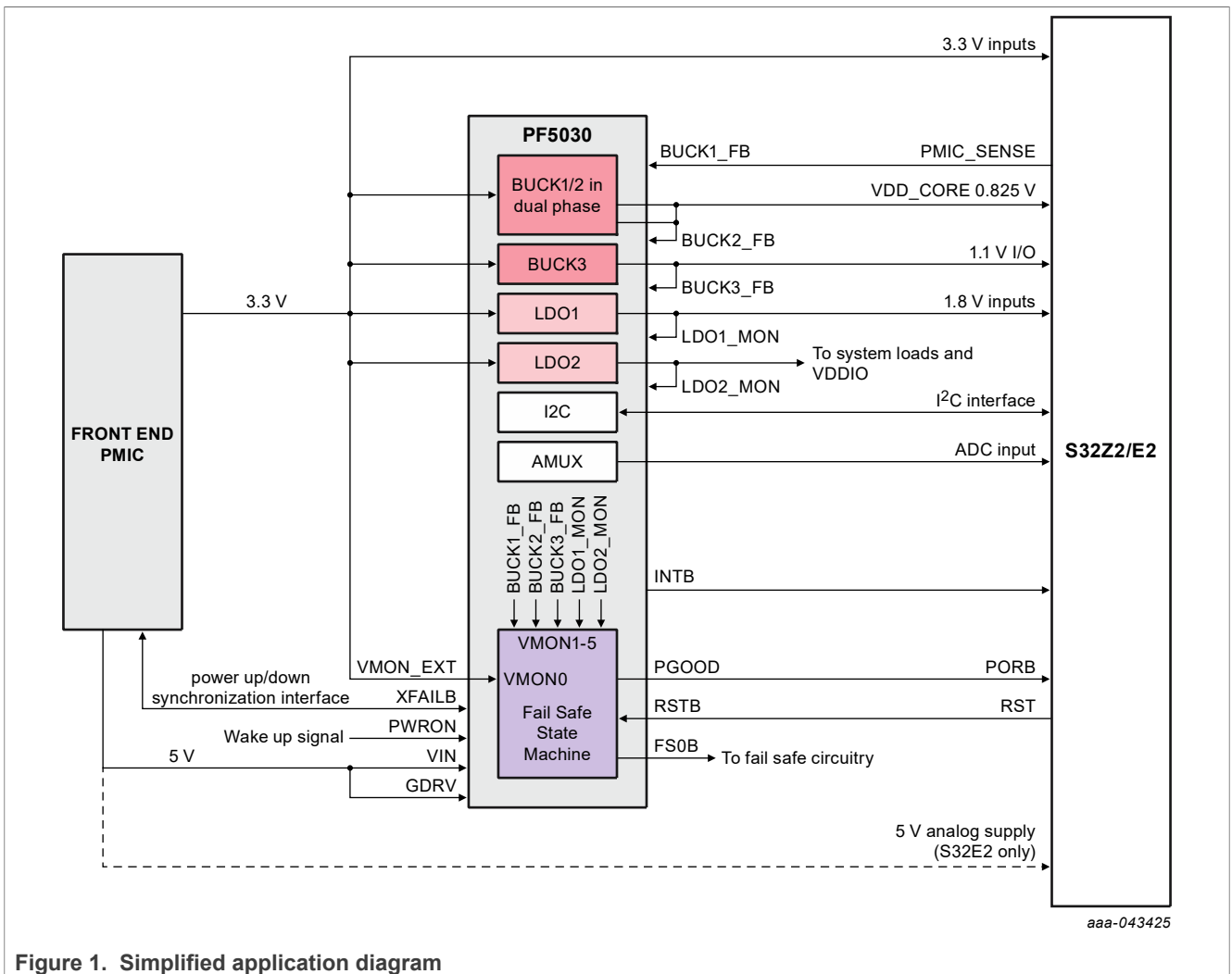

Figure 1. Simplified application diagram

5 Ordering information

5.1 Device family

The PF5030 device family (called PF5030 hereafter) provides selectable features based on part numbering and OTP configuration.

Table 1. Device options

Family	ASIL		Watchdog	BUCK1/2	BUCK3	LDO1/2
	SG1	SG2				
PF5030xxM	D	QM	Disabled	Enabled	Enabled	Enabled
PF5032xxM					Disabled	
PF5030xxB	D	B	Simple	Enabled	Enabled	Enabled
PF5032xxB					Disabled	
PF5030xxD	D	D	Challenger	Enabled	Enabled	Enabled
PF5032xxD					Disabled	

5.2 Part numbering

M	PF	5030	A	M	D	A0	ES
P: prototype M: standard S: custom	LV PMIC	PF5030 core ID ^[1]	Silicon revision A: A0 B: A1	Ambient temperature (T _A) M: -40 °C to 125 °C	ASIL on SG2 M: QM B: ASIL B D: ASIL D	OTP code A0: OTP A0 xx: OTP xx	Package type ES: dimple wetable flank

[1] See [Table 1](#)

Table 2. Ordering information

Part Number ^[1]	Application	ASIL		Package		
		SG1	SG2	Name	Description	Version
MPF5030BMMA0ES	Greenbox III S32Z2 DC2 EVB S32E2 DC4 EVB FS86 + S32Z2 (21x21 mm) FS86 + S32E2 (27x27 mm)	D	QM	HVQFN40eP	HVQFN40, plastic, thermally enhanced very thin quad flat package, no lead, wettable flanks	SOT618-18(D)
MPF5032BMMA0ES		D	QM			
MPF5030BMBA0ES		D	B			
MPF5032BMBA0ES		D	B			
MPF5030BMBA0ES		D	D			
MPF5032BMBA0ES		D	D			
MPF5030BMMA4ES		D	QM			
MPF5032BMMA5ES	S32Z2 DC1 EVB FS86 + S32Z2 (17x17 mm)	D	QM			
PPF5030AMDA0ES ^[2]	Prototype / Evaluation	D	QM, B, D			

Table 2. Ordering information...continued

Part Number ^[1]	Application	ASIL		Package		
		SG1	SG2	Name	Description	Version
PPF5030BMDA0ES^[3]	Prototype / Evaluation	D	QM, B, D			

[1] To order parts in tape and reel, add the R2 suffix to the part number.

[2] Superset part number that can cover all features for prototype ordering (A0 silicon pass / obsolete).

[3] Superset part number that can cover all features for prototype ordering (A1 silicon pass).

Part numbers ending with A0 OTP code are non-programmed OTP configuration. Preprogrammed OTP configurations are managed through part number extension. For a custom OTP configuration, contact your local NXP sales representative.

6 Internal block diagram

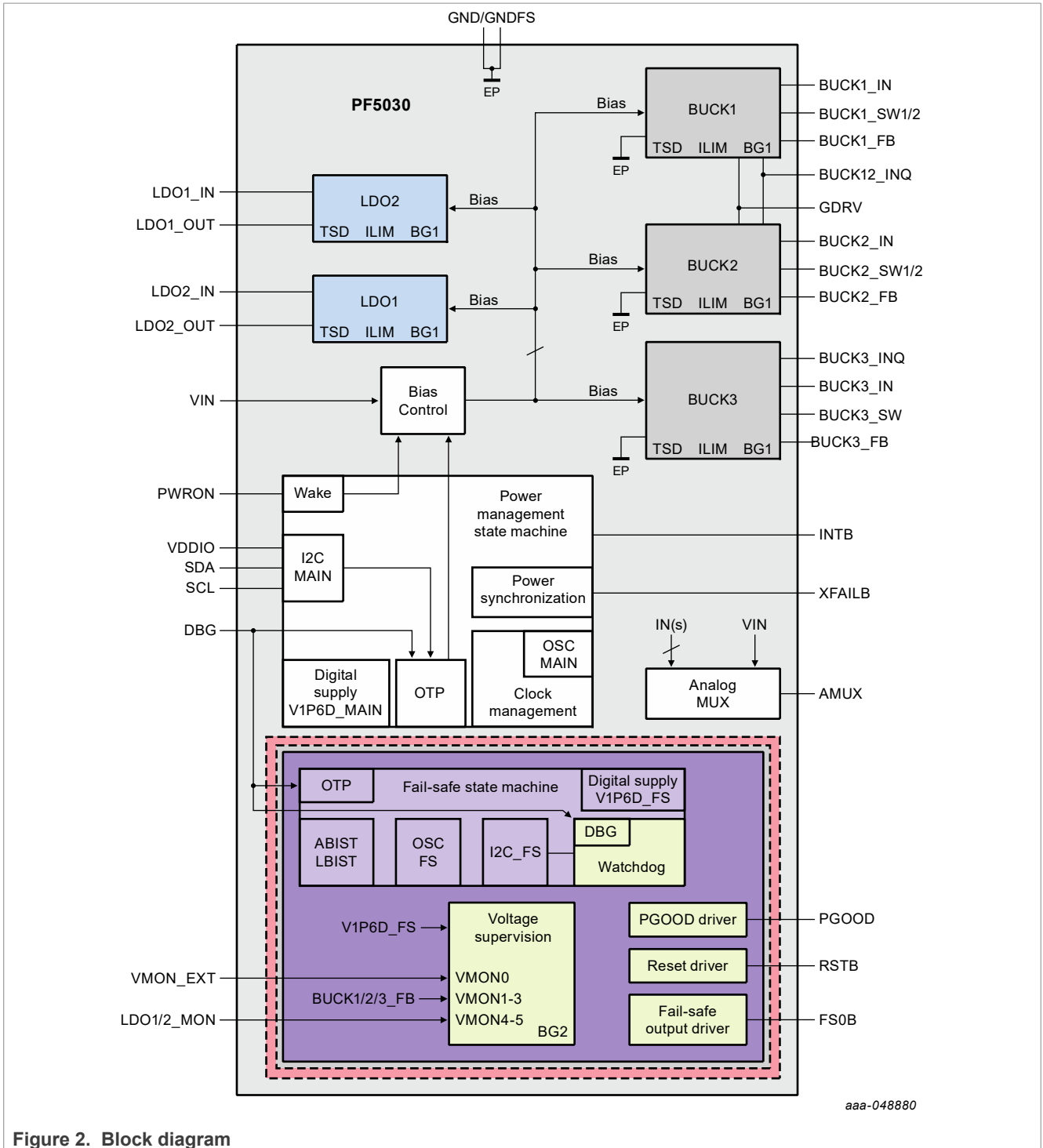

Figure 2. Block diagram

7 Pinning information

7.1 Pinout

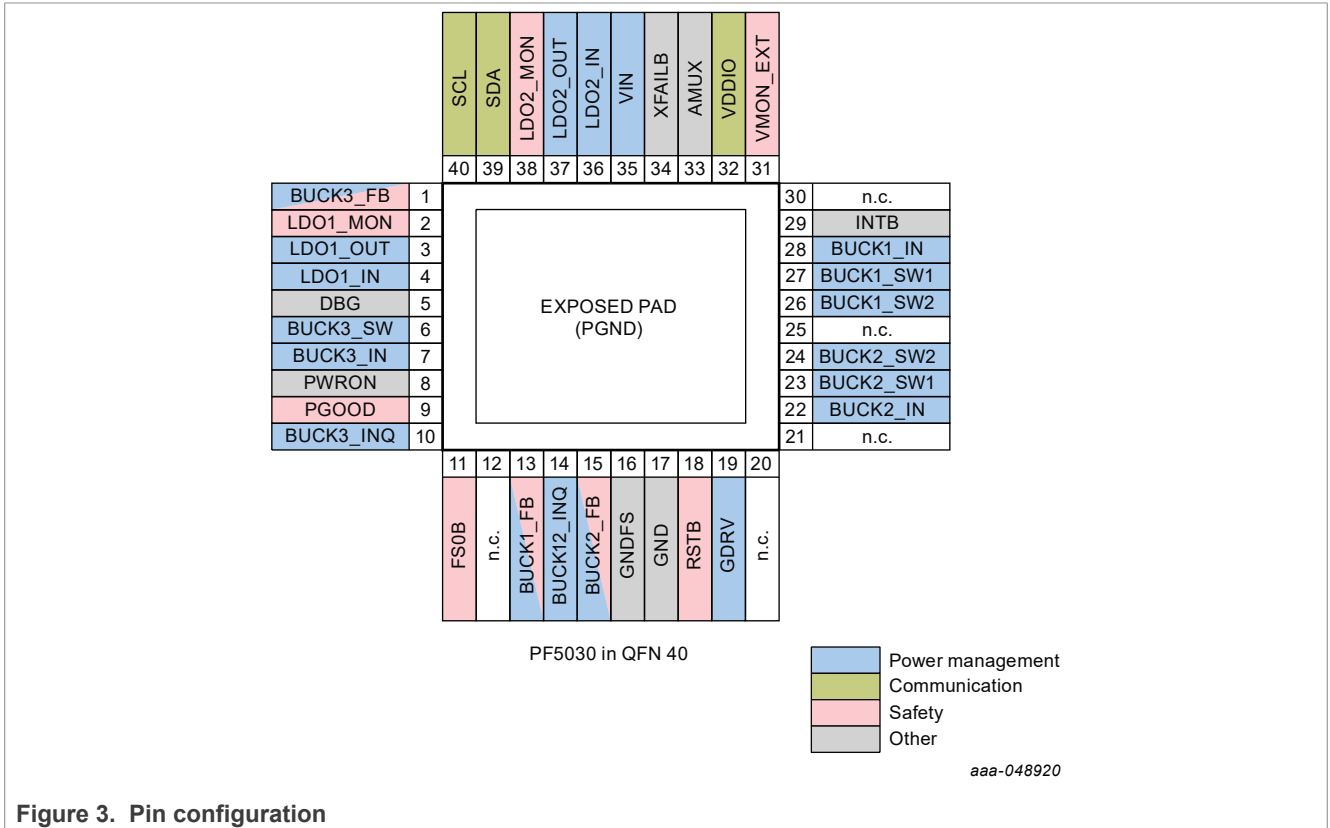

Figure 3. Pin configuration

7.2 Pin description

Table 3. Pin description

Pin	Name	Type	Description
1	BUCK3_FB	Analog input	BUCK3 voltage feedback
2	LDO1_MON	Analog input	LDO1 / VMON4 voltage monitor input
3	LDO1_OUT	Analog output	LDO1 output voltage
4	LDO1_IN	Analog input	LDO1 input voltage
5	DBG	Analog input	Debug mode entry and OTP programming input supply
6	BUCK3_SW	Analog output	BUCK3 switching node
7	BUCK3_IN	Analog input	BUCK3 input voltage
8	PWRON	Digital input	PWRON input for power-up
9	PGOOD	Digital output	Power good output. Active Low. Open drain structure.
10	BUCK3_INQ	Analog input	Quiet input voltage for BUCK3
11	FS0B	Digital output	Fail-safe output 0. Active Low. Open drain structure.

Table 3. Pin description...continued

Pin	Name	Type	Description
12	n.c.	Not connected	Not connected pin
13	BUCK1_FB	Analog input	BUCK1 voltage feedback
14	BUCK12_INQ	Analog input	Quiet input voltage for BUCK1 and BUCK2
15	BUCK2_FB	Analog input	BUCK2 voltage feedback
16	GNDIFS	Ground	Analog ground pin for fail-safe domain
17	GND	Ground	Analog ground pin for main domain
18	RSTB	Digital input/output	Reset input/output. Active Low. Open drain structure.
19	GDRV	Analog input	Gate drive supply pin for BUCK1 and BUCK2
20	n.c.	Not connected	Not connected pin
21	n.c.	Not connected	Not connected pin
22	BUCK2_IN	Analog input	BUCK2 input voltage
23	BUCK2_SW1	Analog output	BUCK2 switching node pin #1
24	BUCK2_SW2	Analog output	BUCK2 switching node pin #2
25	n.c.	Not connected	Not connected pin
26	BUCK1_SW2	Analog output	BUCK1 switching node pin #2
27	BUCK1_SW1	Analog output	BUCK1 switching node pin #1
28	BUCK1_IN	Analog input	BUCK1 input voltage
29	INTB	Digital output	Interrupt output
30	n.c.	Not connected	Not connected pin
31	VMON_EXT	Analog input	External voltage monitoring
32	VDDIO	Analog input	I/O supply voltage
33	AMUX	Analog output	Analog multiplexer output
34	XFAILB	Digital input/output	External PMIC synchronization pin
35	VIN	Analog input	Main input supply
36	LDO2_IN	Analog input	LDO2 input voltage
37	LDO2_OUT	Analog output	LDO2 output voltage
38	LDO2_MON	Analog input	LDO2 / VMON5 voltage monitor input
39	SDA	Digital input/output	I ² C data signal
40	SCL	Digital input	I ² C clock signal
EP	Exposed pad	Ground	Exposed pad must be connected to GND

8 Limiting values

Table 4. Maximum ratings

All voltages are with respect to ground, unless otherwise noted. Exceeding these ratings may cause a malfunction or permanent damage to the device.

Symbol	Conditions	Parameter	Min	Max	Unit
Voltage ratings					
GND, GNDFS	DC voltage	GND pins	-0.3	0.3	V
FS0B	DC voltage	FS0B pin	-0.3	40	V
DBG	DC voltage	DBG pin	-0.3	10	V
VIN	DC voltage	VIN pin	-0.3	5.5	V
	Transient voltage up to 2.2 μ s		-0.3	6	
BUCKx_IN	DC Voltage	BUCKx_IN pin x from 1 to 3	-0.3	5.5	V
	Transient voltage < 3 μ s		-0.3	6.5	
BUCKx_SWy	Transient voltage < 20 ns	BUCKx_SWy pin x from 1 to 3, y = none, 1 or 2	-0.3	6.5	V
All other pins	DC voltage	all other pins	-0.3	5.5	V

9 Electrostatic discharge

9.1 Human body model (JESD22/A114)

The device is protected up to ± 2 kV, according to the human body model standard with 100 pF and 1.5 k Ω . This protection is ensured at all pins.

9.2 Charged device model

The device is protected up to ± 750 V on corner pins and up to ± 500 V on all other pins, according to the AEC Q100 - 011 charged device model standard.

9.3 Discharged contact test

The FS0B pin is protected up to ± 8 kV, according to the following discharged contact tests.

- Discharged contact test (IEC61000-4-2) at 150 pF and 330 Ω
- Discharged contact test (ISO10605.2008) at 150 pF and 2 k Ω
- Discharged contact test (ISO10605.2008) at 330 pF and 2 k Ω

10 Thermal characteristics

Table 5. Temperature ranges

Symbol	Description (Rating)	Min	Max	Unit
Thermal ratings				
T _A	Ambient temperature (Grade 1)	-40	125	°C
T _J	Junction temperature (Grade 1)	-40	150	°C

Table 5. Temperature ranges...continued

Symbol	Description (Rating)	Min	Max	Unit
T _{STG}	Storage Temperature	-55	150	°C

Table 6. Thermal resistance (per JEDEC JESD51-2)

Symbol	Description	Value ^[1]	Unit
R _{θJA}	Thermal resistance Junction to Ambient ^[2]	30.1	°C/W
R _{θJCBOTTOM}	Thermal resistance Junction to Case Bottom ^{[3][4]} (with uniform power dissipation on the silicon die)	2.4	°C/W
R _{θJCTOP}	Thermal resistance Junction to Case Top ^[5] (with uniform power dissipation on the silicon die)	20.6	°C/W
Ψ _{JT}	Thermal characterization parameter Junction to Top ^[2]	0.3	°C/W

[1] Thermal test board meets JEDEC specification for this package (JESD51-7).

[2] Determined in accordance to JEDEC JESD51-2A natural convection environment. Thermal resistance data in this report is solely for a thermal performance comparison of one package to another in a standardized specified environment. It is not meant to predict the performance of a package in an application-specific environment.

[3] Thermal resistance between the die and the printed circuit board. Board temperature is measured on the top surface of the board near the package.

[4] For exposed pad packages where the pad would be expected to be soldered, junction to case thermal resistance is a simulated value from the junction to the exposed pad without contact resistance.

[5] Junction-to-Case Top thermal resistance determined using an isothermal cold plate. Case temperature refers to the mold surface temperature at the package top side dead center.

11 Package outline

PF5030 package is a QFN, thermally enhanced, wettable flanks, 6 x 6 x 0.85 mm, 0.5 mm pitch, 40 pins.

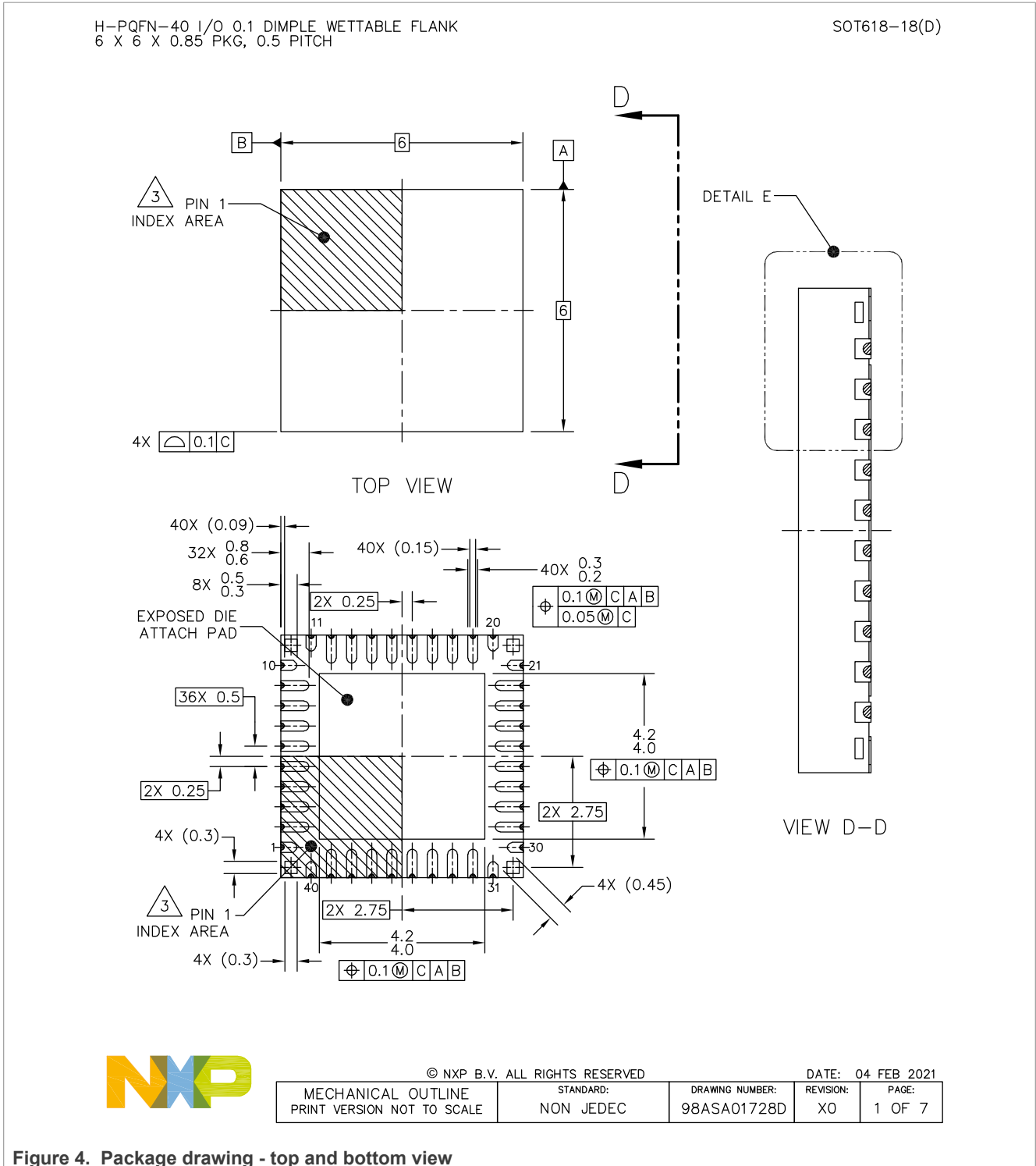
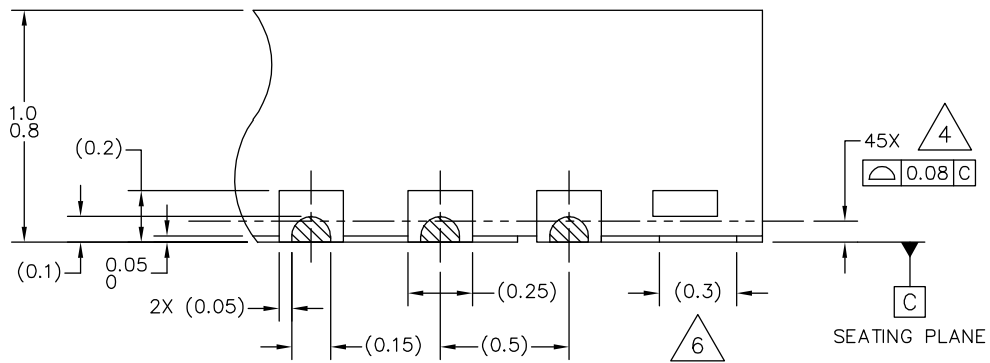

Figure 4. Package drawing - top and bottom view

H-PQFN-40 I/O 0.1 DIMPLE WETTABLE FLANK
 6 X 6 X 0.85 PKG, 0.5 PITCH

SOT618-18(D)



DETAIL E
 VIEW ROTATED 90° CW



© NXP B.V. ALL RIGHTS RESERVED

DATE: 04 FEB 2021

MECHANICAL OUTLINE PRINT VERSION NOT TO SCALE	STANDARD: NON JEDEC	DRAWING NUMBER: 98ASA01728D	REVISION: X0	PAGE: 2
--	------------------------	--------------------------------	-----------------	------------

Figure 5. Package drawing - dimple wettable flank

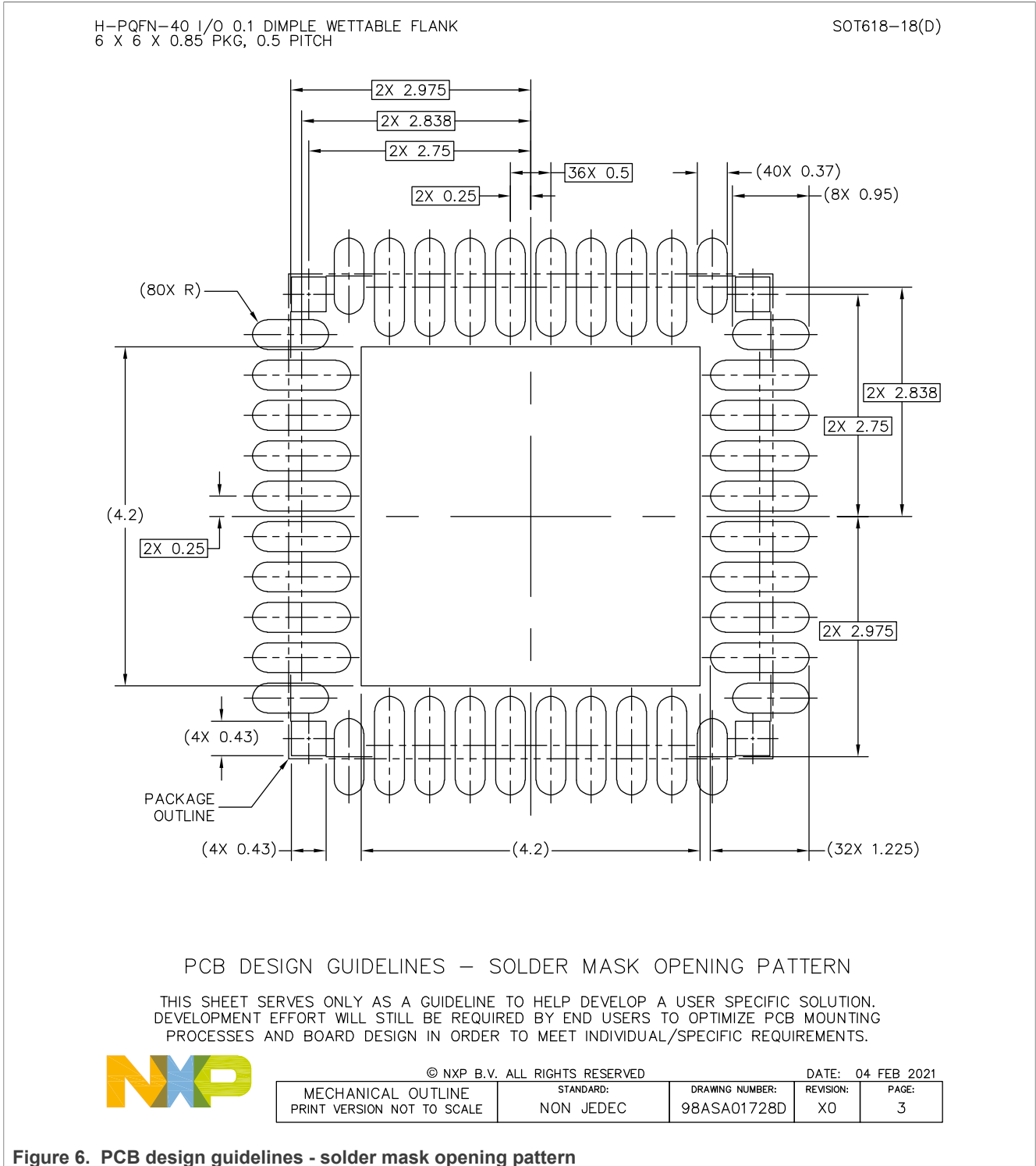

Figure 6. PCB design guidelines - solder mask opening pattern

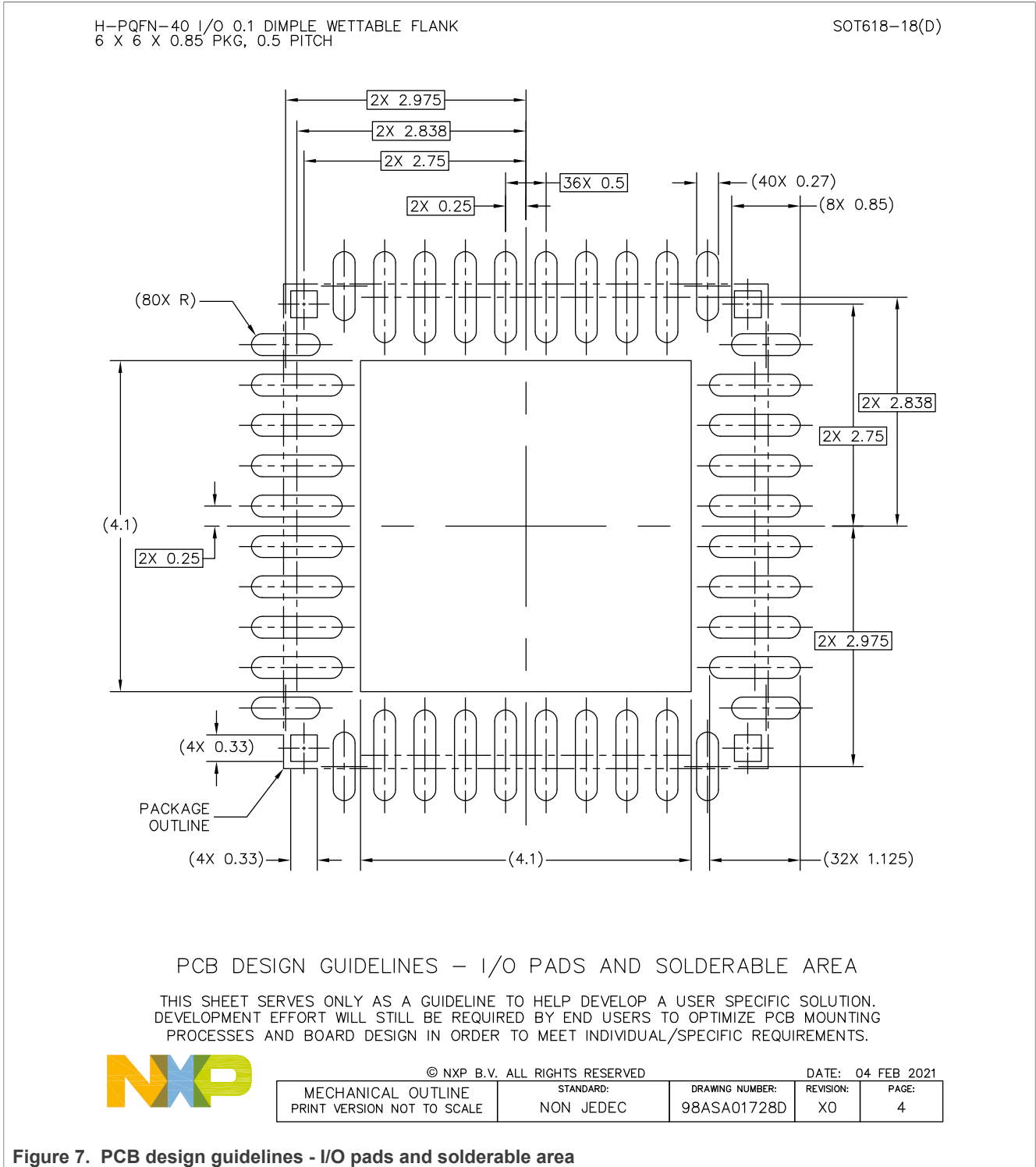

Figure 7. PCB design guidelines - I/O pads and solderable area

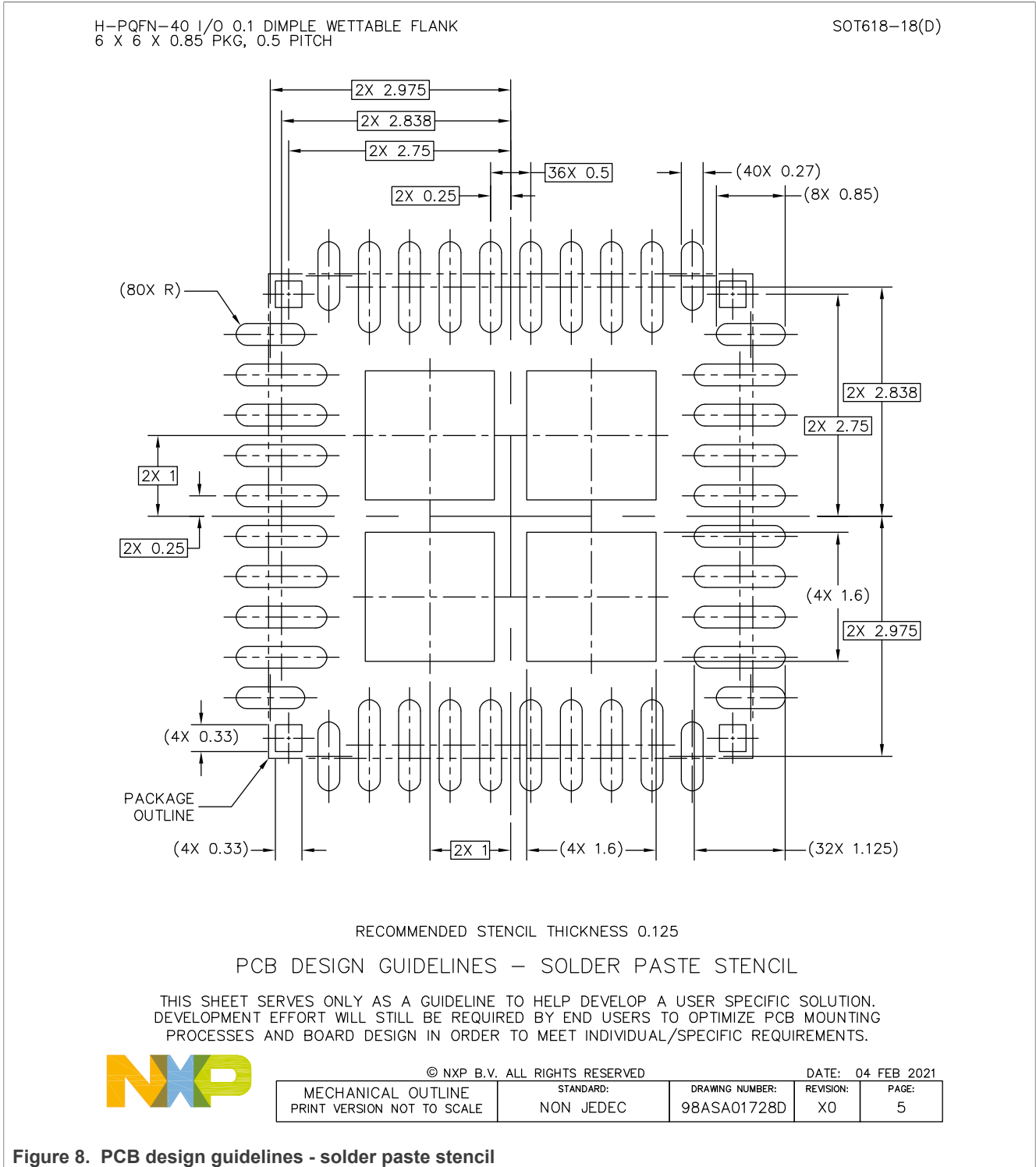

Figure 8. PCB design guidelines - solder paste stencil

H-PQFN-40 I/O 0.1 DIMPLE WETTABLE FLANK
 6 X 6 X 0.85 PKG, 0.5 PITCH

SOT618-18(D)

NOTES:

1. ALL DIMENSIONS ARE IN MILLIMETERS.
2. DIMENSIONING AND TOLERANCING PER ASME Y14.5M-1994.
3. PIN 1 FEATURE SHAPE, SIZE AND LOCATION MAY VARY.
4. COPLANARITY APPLIES TO LEADS AND DIE ATTACH FLAG.
5. MIN. METAL GAP FOR LEAD TO EXPOSED PAD SHALL BE 0.2 MM.
6. ANCHORING PADS.



© NXP B.V. ALL RIGHTS RESERVED

DATE: 04 FEB 2021

MECHANICAL OUTLINE PRINT VERSION NOT TO SCALE	STANDARD: NON JEDEC	DRAWING NUMBER: 98ASA01728D	REVISION: X0	PAGE: 6
--	------------------------	--------------------------------	-----------------	------------

Figure 9. Notes

12 Revision History

Table 7. Revision history

Document ID	Release date	Data sheet status	Change notice	Supersedes
PF5030_SDS v. 2	20230317	Product Data Sheet	202303007I	PF5030_SDS v. 1
	<ul style="list-style-type: none"> Revised Section 1 Revised Section 2 Changed titles of Section 7, Section 8, and Section 11 to conform to NXP template Revised Table 1 Revised Table 2 Revised title and content of Table 5 Added Table 6 			
PF5030_SDS v. 1	20221122	Product Data Sheet	—	—
Modifications:	<ul style="list-style-type: none"> Initial Release 			

13 Legal information

13.1 Data sheet status

Document status ^{[1][2]}	Product status ^[3]	Definition
Objective [short] data sheet	Development	This document contains data from the objective specification for product development.
Preliminary [short] data sheet	Qualification	This document contains data from the preliminary specification.
Product [short] data sheet	Production	This document contains the product specification.

[1] Please consult the most recently issued document before initiating or completing a design.

[2] The term 'short data sheet' is explained in section "Definitions".

[3] The product status of device(s) described in this document may have changed since this document was published and may differ in case of multiple devices. The latest product status information is available on the Internet at URL <http://www.nxp.com>.

13.2 Definitions

Draft — A draft status on a document indicates that the content is still under internal review and subject to formal approval, which may result in modifications or additions. NXP Semiconductors does not give any representations or warranties as to the accuracy or completeness of information included in a draft version of a document and shall have no liability for the consequences of use of such information.

Short data sheet — A short data sheet is an extract from a full data sheet with the same product type number(s) and title. A short data sheet is intended for quick reference only and should not be relied upon to contain detailed and full information. For detailed and full information see the relevant full data sheet, which is available on request via the local NXP Semiconductors sales office. In case of any inconsistency or conflict with the short data sheet, the full data sheet shall prevail.

Product specification — The information and data provided in a Product data sheet shall define the specification of the product as agreed between NXP Semiconductors and its customer, unless NXP Semiconductors and customer have explicitly agreed otherwise in writing. In no event however, shall an agreement be valid in which the NXP Semiconductors product is deemed to offer functions and qualities beyond those described in the Product data sheet.

13.3 Disclaimers

Limited warranty and liability — Information in this document is believed to be accurate and reliable. However, NXP Semiconductors does not give any representations or warranties, expressed or implied, as to the accuracy or completeness of such information and shall have no liability for the consequences of use of such information. NXP Semiconductors takes no responsibility for the content in this document if provided by an information source outside of NXP Semiconductors.

In no event shall NXP Semiconductors be liable for any indirect, incidental, punitive, special or consequential damages (including - without limitation - lost profits, lost savings, business interruption, costs related to the removal or replacement of any products or rework charges) whether or not such damages are based on tort (including negligence), warranty, breach of contract or any other legal theory.

Notwithstanding any damages that customer might incur for any reason whatsoever, NXP Semiconductors' aggregate and cumulative liability towards customer for the products described herein shall be limited in accordance with the Terms and conditions of commercial sale of NXP Semiconductors.

Right to make changes — NXP Semiconductors reserves the right to make changes to information published in this document, including without limitation specifications and product descriptions, at any time and without notice. This document supersedes and replaces all information supplied prior to the publication hereof.

Applications — Applications that are described herein for any of these products are for illustrative purposes only. NXP Semiconductors makes no representation or warranty that such applications will be suitable for the specified use without further testing or modification.

Customers are responsible for the design and operation of their applications and products using NXP Semiconductors products, and NXP Semiconductors accepts no liability for any assistance with applications or customer product design. It is customer's sole responsibility to determine whether the NXP Semiconductors product is suitable and fit for the customer's applications and products planned, as well as for the planned application and use of customer's third party customer(s). Customers should provide appropriate design and operating safeguards to minimize the risks associated with their applications and products.

NXP Semiconductors does not accept any liability related to any default, damage, costs or problem which is based on any weakness or default in the customer's applications or products, or the application or use by customer's third party customer(s). Customer is responsible for doing all necessary testing for the customer's applications and products using NXP Semiconductors products in order to avoid a default of the applications and the products or of the application or use by customer's third party customer(s). NXP does not accept any liability in this respect.

Limiting values — Stress above one or more limiting values (as defined in the Absolute Maximum Ratings System of IEC 60134) will cause permanent damage to the device. Limiting values are stress ratings only and (proper) operation of the device at these or any other conditions above those given in the Recommended operating conditions section (if present) or the Characteristics sections of this document is not warranted. Constant or repeated exposure to limiting values will permanently and irreversibly affect the quality and reliability of the device.

Terms and conditions of commercial sale — NXP Semiconductors products are sold subject to the general terms and conditions of commercial sale, as published at <http://www.nxp.com/profile/terms>, unless otherwise agreed in a valid written individual agreement. In case an individual agreement is concluded only the terms and conditions of the respective agreement shall apply. NXP Semiconductors hereby expressly objects to applying the customer's general terms and conditions with regard to the purchase of NXP Semiconductors products by customer.

No offer to sell or license — Nothing in this document may be interpreted or construed as an offer to sell products that is open for acceptance or the grant, conveyance or implication of any license under any copyrights, patents or other industrial or intellectual property rights.

Quick reference data — The Quick reference data is an extract of the product data given in the Limiting values and Characteristics sections of this document, and as such is not complete, exhaustive or legally binding.

Export control — This document as well as the item(s) described herein may be subject to export control regulations. Export might require a prior authorization from competent authorities.

Translations — A non-English (translated) version of a document, including the legal information in that document, is for reference only. The English version shall prevail in case of any discrepancy between the translated and English versions.

Security — Customer understands that all NXP products may be subject to unidentified vulnerabilities or may support established security standards or specifications with known limitations. Customer is responsible for the design and operation of its applications and products throughout their lifecycles to reduce the effect of these vulnerabilities on customer's applications and products. Customer's responsibility also extends to other open and/or proprietary technologies supported by NXP products for use in customer's applications. NXP accepts no liability for any vulnerability. Customer should regularly check security updates from NXP and follow up appropriately. Customer shall select products with security features that best meet rules, regulations, and standards of the intended application and make the ultimate design decisions regarding its products and is solely responsible for compliance with all legal, regulatory, and security related requirements concerning its products, regardless of any information or support that may be provided by NXP.

NXP has a Product Security Incident Response Team (PSIRT) (reachable at PSIRT@nxp.com) that manages the investigation, reporting, and solution release to security vulnerabilities of NXP products.

Suitability for use in automotive applications (functional safety) —

This NXP product has been qualified for use in automotive applications. It has been developed in accordance with ISO 26262, and has been ASIL classified accordingly. If this product is used by customer in the development of, or for incorporation into, products or services (a) used in safety critical applications or (b) in which failure could lead to death, personal injury, or severe physical or environmental damage (such products and services hereinafter referred to as "Critical Applications"), then customer makes the ultimate design decisions regarding its products and is solely responsible for compliance with all legal, regulatory, safety, and security related requirements concerning its products, regardless of any information or support that may be provided by NXP. As such, customer assumes all risk related to use of any products in Critical Applications and NXP and its suppliers shall not be liable for any such use by customer. Accordingly, customer will indemnify and hold NXP harmless from any claims, liabilities, damages and associated costs and expenses (including attorneys' fees) that NXP may incur related to customer's incorporation of any product in a Critical Application.

13.4 Trademarks

Notice: All referenced brands, product names, service names, and trademarks are the property of their respective owners.

NXP — wordmark and logo are trademarks of NXP B.V.

Tables

Tab. 1.	Device options	4	Tab. 5.	Temperature ranges	9
Tab. 2.	Ordering information	4	Tab. 6.	Thermal resistance (per JEDEC JESD51-2) ...	10
Tab. 3.	Pin description	7	Tab. 7.	Revision history	17
Tab. 4.	Maximum ratings	9			

Figures

Fig. 1.	Simplified application diagram	3	Fig. 7.	PCB design guidelines - I/O pads and solderable area	14
Fig. 2.	Block diagram	6	Fig. 8.	PCB design guidelines - solder paste stencil	15
Fig. 3.	Pin configuration	7	Fig. 9.	Notes	16
Fig. 4.	Package drawing - top and bottom view	11			
Fig. 5.	Package drawing - dimple wettable flank	12			
Fig. 6.	PCB design guidelines - solder mask opening pattern	13			