



## High-Reliability Non-Hermetic TVS Products Portfolio



**Introduction**

High-Reliability TVS Up-Screening Matrix.....	4
TVS Diodes for Protection of Avionics.....	5
Tutorial on TVS Device Selection.....	6
TVS Symbols and Definitions.....	7
TVS Application Note.....	7
High-Reliability TVS Component Summary .....	7

**MUPT/MSMB/MSMC/MSML Surface-Mount Devices**

MUPT Powermite .....	8
Features and Part Nomenclature .....	8
MSMB Electrical Characteristics and Pad Layout.....	9
MSMC Electrical Characteristics and Pad Layout.....	10
MSML Electrical Characteristics and Pad Layout .....	11

**MSMC Low Capacitance Surface-Mount Devices**

Features and Part Nomenclature .....	12
MSMCxLCE 1.5 kW Electrical Characteristics and Pad Layout.....	13

**MSMB Low Capacitance Surface-Mount Devices**

Features and Part Nomenclature .....	15
MSMBxSAC 600 W Electrical Characteristics and Pad Layout.....	15

**MPLAD Surface-Mount Devices**

Features and Part Nomenclature .....	16
MPLAD6.5KP Electrical Characteristics .....	17
MPLAD7.5KP Electrical Characteristics .....	18
MPLAD18KP Electrical Characteristics .....	19
MPLAD36KP Electrical Characteristics .....	20

**MP4KE/MP6KE/M1.5KE Axial Devices**

Features and Part Nomenclature .....	21
MP4KE Electrical Characteristics .....	22
MP6KE Electrical Characteristics .....	23
M1.5KE Electrical Characteristics .....	24

**MLCE Low-Capacitance Axial Devices**

Features and Part Nomenclature .....	25
MLCE Electrical Characteristics .....	26

**M5KP/M15KP Axial Devices**

Features and Part Nomenclature .....	27
M5KP Electrical Characteristics .....	28
M15KP Electrical Characteristics .....	29

**MRT100KP Axial Devices**

Features and Part Nomenclature .....	30
MRT100KP Electrical Characteristics.....	31

**MRT130KP Transient Voltage Suppressor**

Features and Electrical Characteristics.....	32
--	----

**MRT65KP Transient Voltage Suppressor**

Features and Electrical Characteristics.....	33
--	----

**MDA Transient Voltage Suppressor.....34**

Features and Part Nomenclature .....	34
MDA Electrical Characteristics .....	34

**Package Outline Drawings.....35**

## High-Reliability Non-Hermetic Transient Voltage Suppressor (TVS) Products

Standard commercial-grade semiconductor testing may not detect some types of problems such as cracked die or ionic contamination. These and other defects lead to early life failures, and screening for them is particularly important in large-die devices. Microchip's high-reliability non-hermetic/plastic products under go through an up-screening program modeled on JANxxx Military Qualification Procedures uncover these defects and reduce or eliminate the region of early life failures. The tests are defined in MIL-PRF-19500, Appendix E, Table IV.

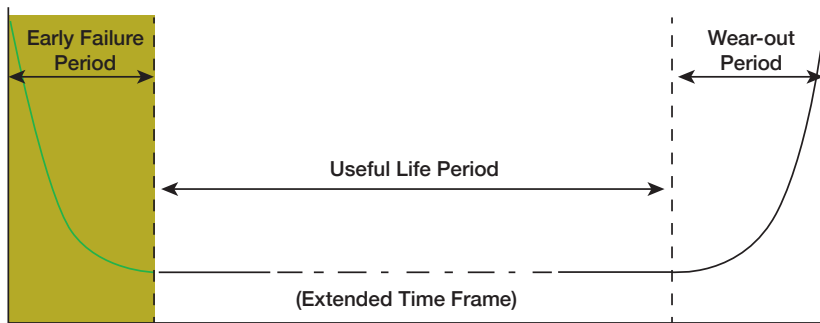

Microchip's high-reliability program also provides for date coding and lot traceability of all devices, continuous reliability monitoring, and controlled foundry, assembly, and test locations. Customers are also provided a full Certificate of Conformance with every lot. Any product changes are made only under a process/product change notification process with the customer.

We offer 3 levels of cost effective up-screening for more robust applications, such as avionics flight hardware, where even a very low level of device mortality is unacceptable. The available screening processes are described in the accompanying tables and are defined as MA, MXL and MX screening processes. These screening processes are recommended for all robust or harsh environmental applications, and for all power levels. You do not need to create source control drawings nor define screening flows to specify these up-screening options.

**Examples: MA1.5KE48CA or MXMSMLJ43CA**

Custom flows are always available from Microchip to support application specific requirements.

Within the metal and composite shell of every jetliner, tens of thousands of sensitive semiconductor components perform critical functions from navigation to engine control. Since aircraft are struck by lightning on average once every thousand flying hours, protection of sensitive electronic devices is essential.

Process, Screen or Test Description	Product Assurance Level Requirement			
	M	MA	MXL	MX
100% DC Electrical Test, Go/No-Go	R	R	R	R
3 Sigma lot norm of key parameters	R	R	R	R
Initial Surge Test	1x	1x	1x	1x
Post-Surge Electrical Testing	R	R	R	R
Temperature Cycling Testing	10 Cycles <sup>1</sup>	10 Cycles	20 Cycles	20 Cycles
Post Temperature Cycling Surge	1x <sup>1</sup>	3x	10x	10x
Pre-HTRB Electrical Test, Read & Record			R	R
HTRB		24 hours <sup>2</sup>	96 hours <sup>3</sup>	96 hours <sup>3</sup>
Interim Electrical Test, Read & Record			R	R
Final Electrical Test, Read & Record	go/no-go <sup>1</sup>	go/no-go	R	R
Delta Calculations			R	R
PDA Evaluation			R	R
Group A Conformance Inspection			R	R
Group B Conformance Inspection				R
Group C Conformance Inspection				R
Certificate of Conformance	R	R	R	R

R - Required and performed based on MIL-PRF-19500 conditions and limits

1 - Tests performed on PLAD18KP, PLAD36KP, PLAD6.5KP and PLAD7.5KP only

2 - 24 hours for unidirectional. 24 hours each side for bidirectional.

3 - 96 hours for unidirectional. 48 hours each side for bidirectional.

# High-Reliability Non-Hermetic TVS

## TVS Diodes for Transient Voltage Protection for Avionics and Robust Environments or Applications

Microchip is a world leader in the design, fabrication, qualification and supply of Transient Voltage Suppressors (TVS). Applications include military and medical equipment, telecommunications, computers and their peripherals. Microchip also provides protection to the electronics of engine control systems in the sophisticated avionics and aerospace industries. The company offers a broad portfolio of both uni- and bi-directional discreet plastic TVS devices with power levels from 600W to 130 kW. The qualification test plans and reliability monitoring provided for all these products are in line with the best industry standard practices.

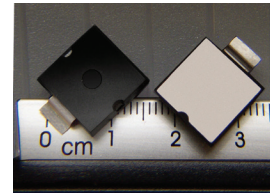

PLAD provides large exposed metal pads on the bottom of the package with excellent direct internal connection to the die.

This catalog includes an exciting expansion in Microchip's industry leading Plastic Large Area Device (PLAD) surface mount package offerings for TVS devices. PLADs provide large exposed metal pads on the bottom of the package with excellent direct internal connection to the die—there are no wire bonds. This provides a very low resistance thermal path, which is much superior to axial leaded devices and is critical in meeting the expanding requirements for multi-stroke and multi-burst event protection in composite body aircraft.

## Multi-Stroke and Multi-Burst TVS Protection

Increasing emphasis is being placed on multi-stroke and multi-burst lightning protection, particularly (but not exclusively) in the protection of the growing proportion of new aircraft being built with largely composite bodies. Test standards for these hazards are defined by RTCA standard DO-160. Microchip's high-reliability plastic PLAD packaged TVS devices are uniquely suited to address these requirements.

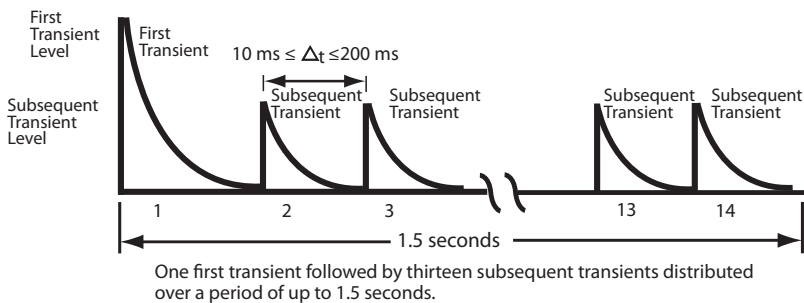
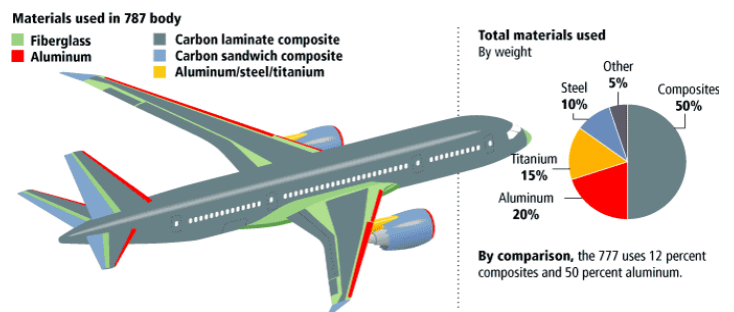

## Multi-Burst Test Specification

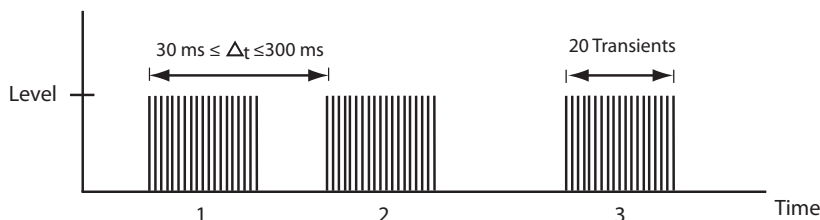

## Tutorial on TVS Component Selection

To use the TVS selection tables in this brochure, you must be able to answer the following questions:

**1. What is the continuous or repetitive peak operating voltage at the circuit location where the TVS will be placed to protect a sensitive load?**

This will determine the Working Standoff Voltage ( $V_{WM}$ ) and minimum Breakdown Voltage ( $V_{BR}$ ) required of the TVS.  $V_{WM}$  is the voltage across the TVS in its off, non-conducting state. You typically match this to the nominal working voltage of the circuit you are protecting.  $V_{BR}$  is the voltage at which avalanche breakdown begins and the TVS starts conducting.  $V_{BR}$  must be greater than the high end of the tolerance range of the operating voltage of the circuit you are protecting.

**2. What is the worst case transient waveform in peak impulse current and pulse shape the TVS needs to divert around the sensitive load?**

This will determine the Peak Surge Current ( $I_{PP}$ ) the TVS must handle, and the correct de-rating factor (if any) required due to the pulse shape. See MicroNote 120.

**3. What is the worst case peak voltage the sensitive load can withstand for the pulse duration in item #2 above?**

This will determine the minimum Clamping Voltage ( $V_C$ ) required of the TVS. This is the voltage across the TVS at the Peak Surge Current ( $I_{PP}$ ).

**4. What is the repetitive peak pulse power dissipation required?**

This will determine the Peak Pulse Power ( $P_{PP}$ ) required of the TVS. It is equal to  $I_{PP} \times V_C$ .

**5. Is the required  $V_C$  lower in value than available on the data sheet for the  $V_{WM}$  described in item #1?**

If the answer is yes, oversizing the  $P_{PP}$  selection for a given pulse condition will reduce  $V_C$  and bring it closer to  $V_{BR}$  and  $V_{WM}$ . Also see MicroNote 108.

**6. Is the pulse shape and duration different than that for which  $P_{PP}$  is specified, or is the waveform of the threat difficult to define?**

$P_{PP}$  is typically rated for one of two standard exponential waveforms – 8/20  $\mu s$  (8  $\mu s$  rise time, 20  $\mu s$  fall time to 50% of peak current) or 10/1000  $\mu s$ . Shorter or longer pulses or different pulse shapes will increase or decrease the peak power the TVS can safely dissipate. See MicroNote 125 for general recommendations regarding industry standards on protection, and MicroNote 120 for advice on adjusting for various waveforms.



# High-Reliability Non-Hermetic TVS

## Symbols and Definitions

Symbol	Definition
$V_{WM}$	<b>Working Standoff Voltage:</b> The voltage across the TVS in its off, non-conducting state.
$V_{BR}$	<b>Breakdown Voltage:</b> The minimum voltage at which avalanche breakdown begins and the TVS starts conducting.
$P_{PP}$	<b>Peak Pulse Power:</b> The peak power that can be applied for a specific pulse width and waveform.
$I_D$	<b>Standby Current:</b> The maximum current that will flow at $V_{WM}$ .
$I_{PP}$	<b>Peak Pulse Current:</b> The peak current that can be applied for a specified pulse width and waveform.
$C$	<b>Capacitance:</b> The capacitance in picofarads of the TVS as defined and at 0V at a frequency of 1 MHz.

## High-Reliability TVS Component Summary

The table below summarizes the Microchip range of high-reliability TVS devices, while the images illustrate the package sizes. New families and packages will shortly be added to the product range.

Product Family	Rated Standoff Voltage $V_{WM}$	Minimum Breakdown Voltage $V_{BR}$	Peak Pulse Power Rating	SMD/Axial	Package
MUPT	5.0 V–48 V	6.0 V–40 V	150 W	SMD	DO-216AA
MSMB	5.0 V–170 V	6.4 V–189 V	600 W	SMD	DO-214AA, DO-215AA
MSMC	5.0 V–170 V	6.4 V–189 V	1.5 kW	SMD	DO-214AB, DO-215AB
MSMCxLCE	6.5 V–170 V	7.22 V–189 V	1.5 kW	SMD	DO-214AB, DO-215AB
MSML	5.0 V–170 V	6.4 V–189 V	3 kW	SMD	DO-214AB, DO-215AB
MPLAD6.5KP	10 V–48 V	11.1 V–189 V	6.5 kW	SMD	mini-PLAD
MPLAD7.5KP	10 V–48 V	11.1 V–189 V	7.5 kW	SMD	mini-PLAD
MPLAD18KP	7.0 V–200 V	7.78 V–222 V	18 kW	SMD	PLAD
MPLAD36KP	14 V–400 V	15.6 V–444 V	36 kW	SMD	PLAD
MP4KE	5.8 V–342 V	6.45 V–380 V	400 W	Axial	DO-41 [DO-04AL]
MP6KE	5.8 V–171 V	6.45 V–190 V	600 W	Axial	T-18
M1.5KE	5.8 V–324 V	6.45 V–380 V	1.5 kW	Axial	Case 1
MLCE	6.5 V–170 V	7.22 V–189 V	1.5 kW	Axial	Case 1
M5KP	5 V–110 V	6.4 V–122 V	5 kW	Axial	Case 5A [DO-204AR]
M15KP	22 V–280 V	24.4 V–311 V	15 kW	Axial	Case 5A [DO-204AR]
MRT100KP	40 V–400 V	44.4 V–444 V	100 kW	Axial	Case 5A [DO-204AR]
MSMBSAC	5.0 V–75 V	7.60 V–83.3 V	500 W	SMD	DO-214AA
MRT130KP	275 V–295 V	300 V	130 kW	Axial	Case 5A [DO-204AR]
MRT65KP	48 V–75 V	53.3 V–83.3 V	65 kW	Axial	Case 5A [DO-204AR]
MDA	6–40 V	6.67–44.4 V	3000 W	SMD	16-pin Dual SIP



## MUPT 5V–48V Powermite1, Surface-Mount Transient Voltage Suppressors

### Features

- Powermite package with standoff voltages 5 V to 48 V.
- Both unidirectional and bidirectional polarities:
  - Anode to case bottom (MUPT5e3 thru MUPT48e3)
  - Bidirectional (MUPTB5e3 thru MUPTB48e3)
  - Reverse polarity (MUPT8Re3 thru MUPT48Re3)
- Operational and storage temperature of –55°C to +150°C
- 100% surge current testing of all parts.
- Moisture classification is Level 1 with no dry pack required per IPC/JEDEC J-STD-020B.
- Both RoHS and non-RoHS compliant versions available.

### Part Nomenclature

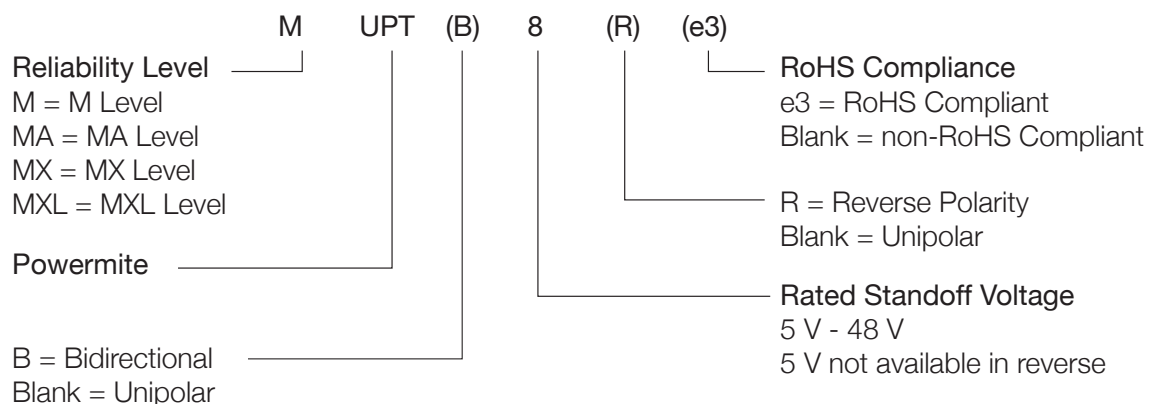

Device Type		Rated Standoff Voltage V <sub>WM</sub>	Minimum Breakdown Voltage V <sub>(BR)</sub> @ 1 mA	Maximum Standby Current I <sub>D</sub> @ V <sub>WM</sub>	Maximum Peak Pulse Current* I <sub>PP</sub> @ 10/1000 μS	Maximum Clamping Voltage V <sub>C</sub> @ I <sub>PP</sub>	Maximum Temperature Coefficient of V <sub>(BR)</sub> aV <sub>(BR)</sub> /°C
Uni-directional	Bi-directional	V	V	μA	A	V	%/°C
MUPT5	MUPTB5	5	6.0	50	15.7	9.5	0.030
MUPT8	MUPTB8	8	9.0	2	10.9	13.7	0.040
MUPT10	MUPTB10	10	11.0	2	8.33	18.0	0.045
MUPT12	MUPTB12	12	13.8	1	6.94	21.6	0.050
MUPT15	MUPTB15	15	16.7	1	5.77	26.0	0.055
MUPT17	MUPTB17	17	19.0	1	5.14	29.2	0.060
MUPT24	MUPTB24	24	28.4	1	3.47	43.2	0.070
MUPT28	MUPTB28	28	31.0	1	3.13	47.8	0.075
MUPT33	MUPTB33	33	36.8	1	2.65	56.7	0.080
MUPT48	MUPTB48	48	54.0	1	1.78	84.3	0.090



# MSMB/MSMC/MSML Surface-Mount Devices (SMDs)

## MSMx Surface-Mount Devices

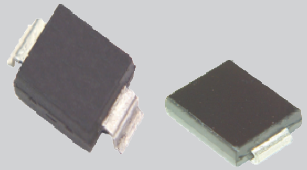
Features	Appearance
<ul style="list-style-type: none"> <li>Both RoHS and non-RoHS compliant versions available</li> <li>Peak pulse power at 10/1000 <math>\mu</math>S                             <ul style="list-style-type: none"> <li>MSMB series – 600 W</li> <li>MSMC series – 1500 W</li> <li>MSML series – 3000 W</li> </ul> </li> <li>100% surge current testing of all parts</li> <li>Standoff voltages of 5 V to 170 V</li> <li>Operational and storage temperature of <math>-55^{\circ}\text{C}</math> to <math>+150^{\circ}\text{C}</math></li> <li>Unidirectional and bidirectional versions available</li> <li>Available in gull-wing and modified J-lead lead forming designs</li> <li>Moisture classification is Level 1 with no dry pack required per IPC/JEDEC J-STD-020B</li> </ul>	

## Part Nomenclature

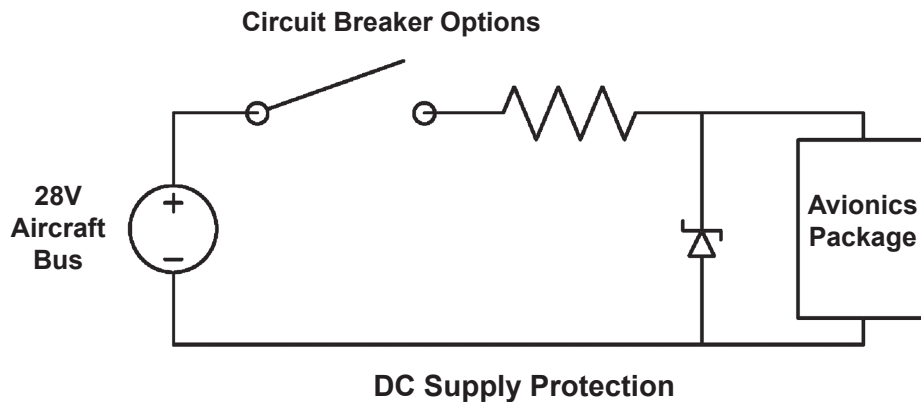
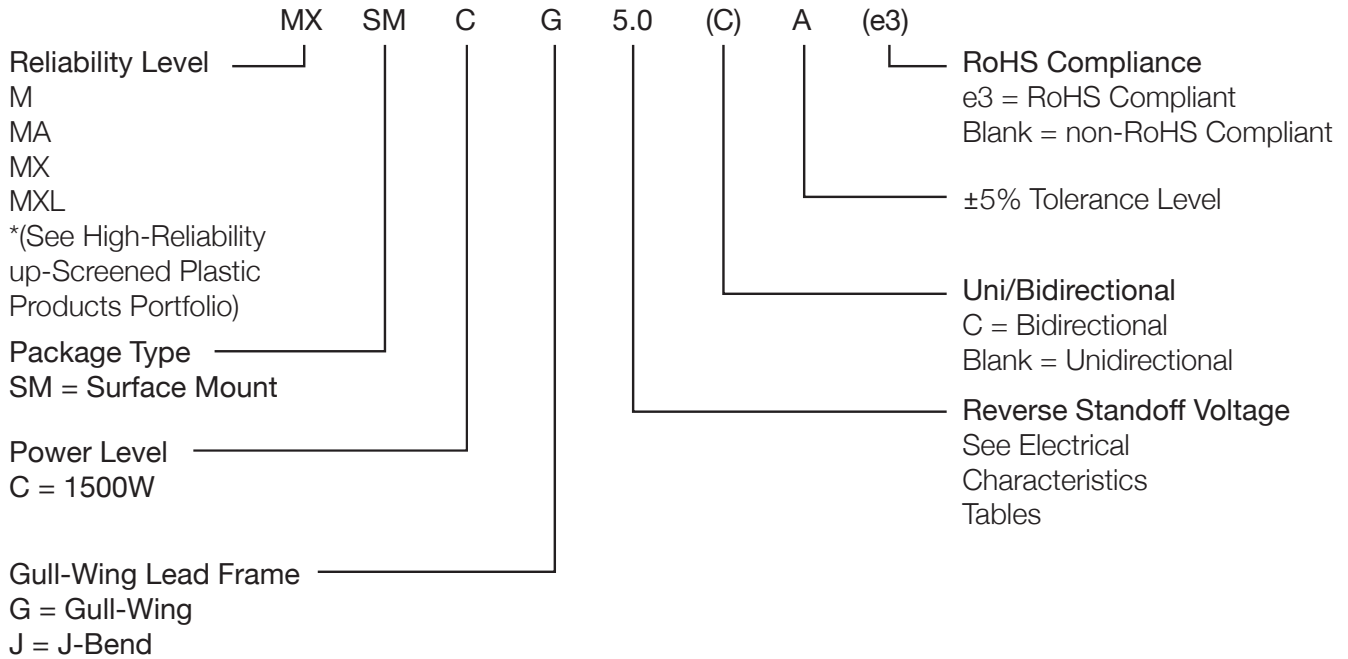

## MSMB 600 Watt, All Electrical Characteristics @ 25°C

Type Number	Reverse Stand-Off Voltage $V_{WM}$ Volts	Minimum Breakdown Voltage $V_{BR}$ Min @ $I_{BR}$ Volts	Breakdown Current $I_{BR}$ mA	Maximum Clamping Voltage @ $I_{PP}$ Vc Volts	Peak Pulse Current $I_{PP}$ Amps	Maximum Standby Current @ $V_{WM}$ Id $\mu$ A
MSMBx5.0A	5.0	6.40	10	9.2	65.2	800
MSMBx6.0A	6.0	6.67	10	10.3	58.3	800
MSMBx6.5A	6.5	7.22	10	11.2	53.6	500
MSMBx7.0A	7.0	7.78	10	12.0	50.0	200
MSMBx7.5A	7.5	8.33	1	12.9	46.5	100
MSMBx8.0A	8.0	8.89	1	13.6	44.1	50
MSMBx8.5A	8.5	9.44	1	14.4	41.7	10
MSMBx9.0A	9.0	10.0	1	15.4	39.0	5
MSMBx10A	10	11.1	1	17.0	35.3	5
MSMBx11A	11	12.2	1	18.2	33.0	5
MSMBx12A	12	13.3	1	19.9	30.2	5
MSMBx13A	13	14.4	1	21.5	27.9	1
MSMBx14A	14	15.6	1	23.2	25.8	1
MSMBx15A	15	16.7	1	24.4	24.0	1
MSMBx16A	16	17.8	1	26.0	23.1	1
MSMBx17A	17	18.9	1	27.6	21.7	1
MSMBx18A	18	20.0	1	29.2	20.5	1
MSMBx20A	20	22.2	1	32.4	18.5	1
MSMBx22A	22	24.4	1	35.5	16.9	1
MSMBx24A	24	26.7	1	38.9	15.4	1
MSMBx26A	26	28.9	1	42.1	14.2	1
MSMBx28A	28	31.1	1	45.4	13.2	1
MSMBx30A	30	33.3	1	48.4	12.4	1
MSMBx33A	33	36.7	1	53.3	11.3	1
MSMBx36A	36	40.0	1	58.1	10.3	1
MSMBx40A	40	44.4	1	64.5	9.3	1
MSMBx43A	43	47.8	1	69.4	8.6	1
MSMBx45A	45	50.0	1	72.7	8.3	1
MSMBx48A	48	53.3	1	77.4	7.7	1
MSMBx51A	51	56.7	1	82.4	7.3	1
MSMBx54A	54	60.0	1	87.1	6.9	1
MSMBx58A	58	64.4	1	93.6	6.4	1
MSMBx60A	60	66.7	1	96.8	6.2	1
MSMBx64A	64	71.1	1	103	5.8	1
MSMBx70A	70	77.8	1	113	5.3	1
MSMBx75A	75	83.3	1	121	4.9	1
MSMBx78A	78	86.7	1	126	4.7	1
MSMBx85A	85	94.4	1	137	4.4	1
MSMBx90A	90	100	1	146	4.1	1
MSMBx100A	100	111	1	162	3.7	1
MSMBx110A	110	122	1	177	3.4	1
MSMBx120A	120	133	1	193	3.1	1
MSMBx130A	130	144	1	209	2.9	1
MSMBx150A	150	167	1	243	2.5	1
MSMBx160A	160	178	1	259	2.3	1
MSMBx170A	170	189	1	275	2.2	1

### Pad Layout

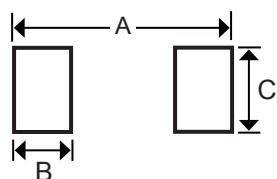

MSMBJ (DO-214AA)		
	Inches	mm
<b>A</b>	0.260	6.60
<b>B</b>	0.085	2.16
<b>C</b>	0.110	2.79

MSMBG (DO-215AA)		
	Inches	mm
<b>A</b>	0.320	8.13
<b>B</b>	0.085	2.16
<b>C</b>	0.110	2.79

# MSMC Surface-Mount Devices

## MSMC 1.5 kW, All Electrical Characteristics @ 25°C

Type Number	Reverse Stand-Off Voltage $V_{WM}$ Volts	Minimum Breakdown Voltage $V_{BR}$ Min. @ I <sub>BR</sub> Volts	Breakdown Current I <sub>BR</sub> mA	Maximum Clamping Voltage @ I <sub>PP</sub> V <sub>C</sub> Volts	Peak Pulse Current I <sub>PP</sub> Amps	Maximum Standby Current @ $V_{WM}$ I <sub>D</sub> mA
MSMCx5.0A	5.0	6.40	10	9.2	163.0	1000
MSMCx6.0A	6.0	6.67	10	10.3	145.6	1000
MSMCx6.5A	6.5	7.22	10	11.2	133.9	500
MSMCx7.0A	7.0	7.78	10	12.0	125.0	200
MSMCx7.5A	7.5	8.33	1	12.9	116.3	100
MSMCx8.0A	8.0	8.89	1	13.6	110.3	50
MSMCx8.5A	8.5	9.44	1	14.4	104.2	20
MSMCx9.0A	9.0	10.0	1	15.4	97.4	10
MSMCx10A	10	11.1	1	17.0	88.2	5
MSMCx11A	11	12.2	1	18.2	82.4	5
MSMCx12A	12	13.3	1	19.9	75.3	5
MSMCx13A	13	14.4	1	21.5	69.7	1
MSMCx14A	14	15.6	1	23.2	64.7	1
MSMCx15A	15	16.7	1	24.4	61.5	1
MSMCx16A	16	17.8	1	26.0	57.7	1
MSMCx17A	17	18.9	1	27.6	53.3	1
MSMCx18A	18	20.0	1	29.2	51.4	1
MSMCx20A	20	22.2	1	32.4	46.3	1
MSMCx22A	22	24.4	1	35.5	42.2	1
MSMCx24A	24	26.7	1	38.9	38.6	1
MSMCx26A	26	28.9	1	42.1	35.6	1
MSMCx28A	28	31.1	1	45.4	33.0	1
MSMCx30A	30	33.3	1	48.4	31.0	1
MSMCx33A	33	36.7	1	53.3	28.1	1
MSMCx36A	36	40.0	1	58.1	25.8	1
MSMCx40A	40	44.4	1	64.5	23.2	1
MSMCx43A	43	47.8	1	69.4	21.6	1
MSMCx45A	45	50.0	1	72.7	20.6	1
MSMCx48A	48	53.3	1	77.4	19.4	1
MSMCx51A	51	56.7	1	82.4	18.2	1
MSMCx54A	54	60.0	1	87.1	17.2	1
MSMCx58A	58	64.4	1	93.6	16.0	1
MSMCx60A	60	66.7	1	96.8	15.5	1
MSMCx64A	64	71.1	1	103.0	14.6	1
MSMCx70A	70	77.8	1	113	13.3	1
MSMCx75A	75	83.3	1	121	12.4	1
MSMCx78A	78	86.7	1	126	11.4	1
MSMCx85A	85	94.4	1	137	10.4	1
MSMCx90A	90	100	1	146	10.3	1
MSMCx100A	100	111	1	162	9.3	1
MSMCx110A	110	122	1	177	8.4	1
MSMCx120A	120	133	1	193	7.8	1
MSMCx130A	130	144	1	209	7.2	1
MSMCx150A	150	167	1	243	6.2	1
MSMCx160A	160	178	1	259	5.8	1
MSMCx170A	170	189	1	275	5.5	1

## PAD Layout

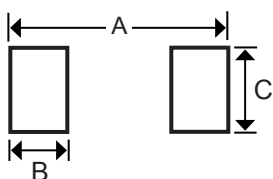

MSMCJ (DO-214AB)		
	Inches	mm
A	0.390	9.90
B	0.110	2.79
C	0.150	3.81

MSMCG (DO-215AB)		
	Inches	mm
A	0.510	12.95
B	0.110	2.79
C	0.150	3.81

**MSML 3 kW, All Electrical Characteristics @ 25°C**

Type Number	Reverse Stand-Off Voltage $V_{WM}$ Volts	Minimum Breakdown Voltage $V_{BR}$ Min. @ $I_{BR}$ Volts	Breakdown Current $I_{BR}$ mA	Maximum Clamping Voltage @ $I_{PP}$ $V_C$ Volts	Peak Pulse Current $I_{PP}$ Amps	Maximum Standby Current @ $V_{WM}$ $I_D$ mA
MSMLx5.0A	5.0	6.40	10	9.2	326.0	1000
MSMLx6.0A	6.0	6.67	10	10.3	291.3	1000
MSMLx6.5A	6.5	7.22	10	11.2	267.9	500
MSMLx7.0A	7.0	7.78	10	12.0	250.0	200
MSMLx7.5A	7.5	8.33	1	12.9	232.6	100
MSMLx8.0A	8.0	8.89	1	13.6	220.6	50
MSMLx8.5A	8.5	9.44	1	14.4	208.4	25
MSMLx9.0A	9.0	10.0	1	15.4	194.8	10
MSMLx10A	10	11.1	1	17.0	176.4	5
MSMLx11A	11	12.2	1	18.2	164.8	5
MSMLx12A	12	13.3	1	19.9	150.6	5
MSMLx13A	13	14.4	1	21.5	139.4	5
MSMLx14A	14	15.6	1	23.2	129.4	2
MSMLx15A	15	16.7	1	24.4	123.0	2
MSMLx16A	16	17.8	1	26.0	115.4	2
MSMLx17A	17	18.9	1	27.6	106.6	2
MSMLx18A	18	20.0	1	29.2	102.8	2
MSMLx20A	20	22.2	1	32.4	92.6	2
MSMLx22A	22	24.4	1	35.5	84.4	2
MSMLx24A	24	26.7	1	38.9	77.2	2
MSMLx26A	26	28.9	1	42.1	71.2	2
MSMLx28A	28	31.1	1	45.4	66.0	2
MSMLx30A	30	33.3	1	48.4	62.0	2
MSMLx33A	33	36.7	1	53.3	56.2	2
MSMLx36A	36	40.0	1	58.1	51.6	2
MSMLx40A	40	44.4	1	64.5	46.4	2
MSMLx43A	43	47.8	1	69.4	43.2	2
MSMLx45A	45	50.0	1	72.7	41.2	2
MSMLx48A	48	53.3	1	77.4	38.8	2
MSMLx51A	51	56.7	1	82.4	36.4	2
MSMLx54A	54	60.0	1	87.1	34.4	2
MSMLx58A	58	64.4	1	93.6	32.0	2
MSMLx60A	60	66.7	1	96.8	31.0	2
MSMLx64A	64	71.1	1	103	29.2	2
MSMLx70A	70	77.8	1	113	26.6	2
MSMLx75A	75	83.3	1	121	24.8	2
MSMLx78A	78	86.7	1	126	22.8	2
MSMLx85A	85	94.4	1	137	20.8	2
MSMLx90A	90	100	1	146	20.6	2
MSMLx100A	100	111	1	162	18.6	2
MSMLx110A	110	122	1	177	16.8	2
MSMLx120A	120	133	1	193	15.6	2
MSMLx130A	130	144	1	209	14.4	2
MSMLx150A	150	167	1	243	12.4	2
MSMLx160A	160	178	1	259	11.6	2
MSMLx170A	170	189	1	275	11.0	2

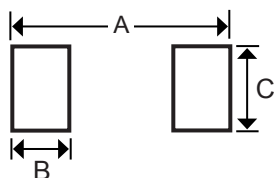
**PAD Layout**

MSMLJ (DO-214AB)		
	Inches	mm
A	0.390	9.90
B	0.110	2.79
C	0.150	3.81

MSMLG (DO-215AB)		
	Inches	mm
A	0.510	12.95
B	0.110	2.79
C	0.150	3.81

# MSMCxLCE Surface-Mount Devices

## MSMCxLCE Low Capacitance 1.5 kW SMDs

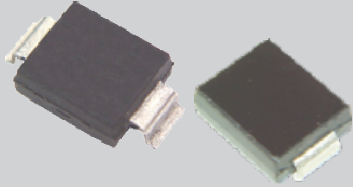
Features	Appearance
<ul style="list-style-type: none"> <li>Both RoHS and non-RoHS compliant versions available</li> <li>1500W peak pulse power at 10/1000 <math>\mu</math>S</li> <li>Standoff voltages of 6.5 V to 170 V</li> <li>Operational and storage temperature of <math>-55^{\circ}\text{C}</math> to <math>+150^{\circ}\text{C}</math></li> <li>Unidirectional versions only</li> <li>Available in Gull-Wing and modified J-lead lead forming designs</li> <li>Uses a rectifier diode in series and in the opposite direction of the protection diode to lower device capacitance</li> <li>Moisture classification is Level 1 with no dry pack required per IPC/JEDEC J-STD-020B</li> <li>100% surge current testing of all parts</li> </ul>	

## Part Nomenclature

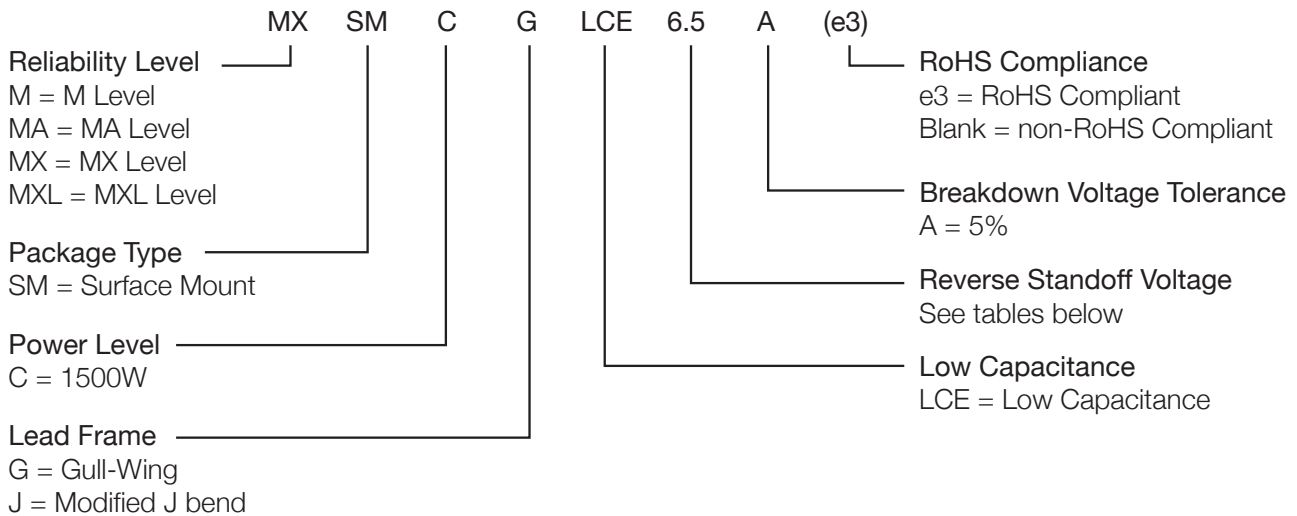

## Sample Part Number

**MXSMCJLCE6.5Ae3** - MX screened surface mount 1.5 kW device, J bend, 6.5 V stand-off, unidirectional low capacitance, 5% tolerance and RoHS compliant.

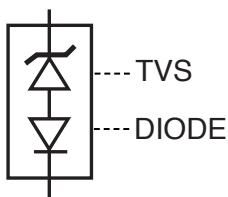

TVS with internal low-capacitance rectifier diode

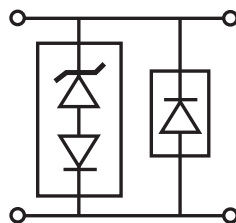

Optional Unidirectional configuration (TVS and separate rectifier diode in parallel)

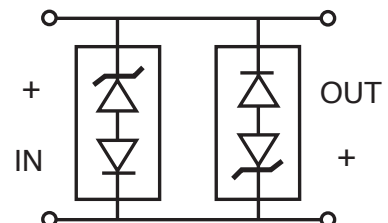

Optional Bidirectional configuration (two TVS devices in parallel)

## MSMCxLCE 1.5 kW, All Electrical Characteristics @ 25°C

Type Number	Reverse Stand-Off Voltage $V_{WM}$ Volts	Minimum Breakdown Voltage $V_{BR}$ Min @ $I_{BR}$ Volts	Breakdown Current $I_{BR}$ mA	Maximum Clamping Voltage @ $I_{PP}$ $V_c$ Volts	Peak Pulse Current $I_{PP}$ Amps	Maximum Standby Current @ $V_{WM}$ $I_D$ mA	Max Cap @ 0 Volts $F=1$ MHz pF	Working Inverse Blocking Voltage $V_{WIB}$ Volts	Inverse Blocking Leakage Current $I_{IB}$ mA	Peak Inverse Blocking Voltage $V_{PIB}$ Volts
MSMCxLCE6.5A	6.5	7.22	10	11.2	100	1000	100	75	10	100
MSMCxLCE7.0A	7.0	7.78	10	12.0	100	500	100	75	10	100
MSMCxLCE7.5A	7.5	8.33	10	12.9	100	250	100	75	10	100
MSMCxLCE8.0A	8.0	8.89	1	13.6	100	100	100	75	10	100
MSMCxLCE8.5A	8.5	9.44	1	14.4	100	50	100	75	10	100
MSMCxLCE9.0A	9.0	10.0	1	15.4	97	10	100	75	10	100
MSMCxLCE10A	10	11.1	1	17.0	88	5	100	75	10	100
MSMCxLCE11A	11	12.2	1	18.2	82	5	100	75	10	100
MSMCxLCE12A	12	13.3	1	19.9	75	5	100	75	10	100
MSMCxLCE13A	13	14.4	1	21.5	70	5	100	75	10	100
MSMCxLCE14A	14	15.6	1	23.2	65	5	100	75	10	100
MSMCxLCE15A	15	16.7	1	24.4	61	5	100	75	10	100
MSMCxLCE16A	16	17.8	1	26.0	57	5	100	75	10	100
MSMCxLCE17A	17	18.9	1	27.6	49	5	100	75	10	100
MSMCxLCE18A	18	20.0	1	29.2	51	5	100	75	10	100
MSMCxLCE20A	20	22.2	1	32.4	46	5	100	75	10	100
MSMCxLCE22A	22	24.4	1	35.5	42	5	100	75	10	100
MSMCxLCE24A	24	26.7	1	38.9	39	5	100	75	10	100
MSMCxLCE26A	26	28.9	1	42.1	36	5	100	75	10	100
MSMCxLCE28A	28	31.1	1	45.5	33	5	100	75	10	100
MSMCxLCE30A	30	33.3	1	48.4	31	5	100	75	10	100
MSMCxLCE33A	33	36.7	1	53.3	28.1	5	100	75	10	100
MSMCxLCE36A	36	40.0	1	58.1	25.8	5	100	75	10	100
MSMCxLCE40A	40	44.4	1	64.5	23.3	5	100	75	10	100
MSMCxLCE43A	43	47.8	1	69.4	21.6	5	100	150	10	200
MSMCxLCE45A	45	50.0	1	72.7	20.6	5	100	150	10	200
MSMCxLCE48A	48	53.3	1	77.4	19.4	5	100	150	10	200
MSMCxLCE51A	51	56.7	1	82.4	18.2	5	100	150	10	200
MSMCxLCE54A	54	60.0	1	87.1	17.2	5	100	150	10	200
MSMCxLCE58A	58	64.4	1	93.6	16.0	5	100	150	10	200
MSMCxLCE60A	60	66.7	1	96.8	15.5	5	90	150	10	200
MSMCxLCE64A	64	71.1	1	103	14.6	5	90	150	10	200
MSMCxLCE70A	70	77.8	1	113	13.3	5	90	150	10	200
MSMCxLCE75A	75	83.3	1	121	12.4	5	90	150	10	200
MSMCxLCE80A	80	88.7	1	129	11.6	5	90	150	10	200
MSMCxLCE90A	90	100	1	146	10.3	5	90	300	10	200
MSMCxLCE100A	100	111	1	162	9.3	5	90	300	10	200
MSMCxLCE110A	110	122	1	178	8.4	5	90	300	10	400
MSMCxLCE120A	120	133	1	193	7.8	5	90	300	10	400
MSMCxLCE130A	130	144	1	209	7.2	5	90	300	10	400
MSMCxLCE150A	150	167	1	243	6.2	5	90	300	10	400
MSMCxLCE160A	160	178	1	259	5.8	5	90	300	10	400
MSMCxLCE170A	170	189	1	275	5.4	5	90	300	10	400

### PAD Layout

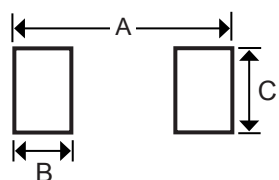

MSMCJ (DO-214AB)		
	Inches	mm
<b>A</b>	.390	9.90
<b>B</b>	.110	2.79
<b>C</b>	.150	3.81

MSMCG (DO-215AB)		
	Inches	mm
<b>A</b>	.510	12.95
<b>B</b>	.110	2.79
<b>C</b>	.150	3.81

# MSMBSAC Surface-Mount Devices

## MSMBSAC Low-Capacitance 600W SMDs

Features	Appearance
<ul style="list-style-type: none"> <li>100% surge tested devices</li> <li>Operational and storage temperature of -55 °C to +150 °C"</li> <li>Low-capacitance performance of 30 pF</li> <li>Suppresses transients up to 600 W peak pulse power @ 10/1000</li> <li>Moisture classification is Level 1 with no dry pack required per IPC/JEDEC J-STD-020B</li> <li>RoHS-compliant devices available by adding an e3 suffix</li> </ul>	

## MSMBSAC5.0 Thru MSMBSAC75, e3, All Electrical Characteristics @ 25°C

Part Number	Reverse Stand-Off Voltage (Note 1) $V_{WM}$ Volts	Breakdown Voltage @ $I_{BR}$ 1.0 mA $V_{BR}$ Volts Min.	Maximum Standby Current @ $V_{WM}$ $I_D$ $\mu$ A	Maximum Clamping Voltage $I_P = 5.0A^* V_C$ Volts	Maximum Peak Pulse Current* Rating $I_{PP}$ Amps	Maximum Capacitance @ 0 Volts, $F = 1$ MHz $P_F$	Working Inverse Blocking Voltage $V_{WIB}$ Volts	Inverse Blocking Leakage Current $I_{IB}$ @ $V_{WIB}$ mA	Peak Inverse Blocking Voltage $V_{PIB}$ Volts
MSMBSAC5.0	5.0	7.60	300	10.0	44	30	75	10	100
MSMBSAC6.0	6.0	7.90	300	11.2	41	30	75	10	100
MSMBSAC7.0	7.0	8.33	300	12.6	38	30	75	10	100
MSMBSAC8.0	8.0	8.89	100	13.4	36	30	75	10	100
MSMBSAC8.5	8.5	9.44	50	14.0	34	30	75	10	100
MSMBSAC10	10	11.10	5.0	16.3	29	30	75	10	100
MSMBSAC12	12	13.30	5.0	19.0	25	30	75	10	100
MSMBSAC15	15	16.70	5.0	23.6	20	30	75	10	100
MSMBSAC18	18	20.00	5.0	28.8	15	30	75	10	100
MSMBSAC22	22	24.40	5.0	35.4	14	30	75	10	100
MSMBSAC26	26	28.90	5.0	42.3	11.1	30	75	10	100
MSMBSAC36	36	40.0	5.0	60.0	8.6	30	75	10	100
MSMBSAC45	45	50.00	5.0	77.0	6.8	30	150	10	200
MSMBSAC50	50	55.50	5.0	88.0	5.8	30	150	10	200
MSMBSAC75	75	83.3	5.0	121	4.1	30	150	10	200

\*See Figure 3. For the MSMBSAC75, the maximum clamping voltage  $V_C$  is at the maximum rated Peak Pulse Current ( $I_{PP}$ ) of 4.1 Amps.

Clamping Factor: The ratio of the numerical value of  $V_C$  to  $V_{BR}$  is typically 1.4 @ full rated power, 1.20 @ 50% rated power. Also see MicroNote 108.

Note 1: A transient voltage suppressor is normally selected according to voltage ( $V_{WM}$ ), that should be equal to or greater than the dc or continuous peak operating voltage level.

Note 2: When pulse testing, test in TVS avalanche direction. Do not pulse in forward direction. See section for Schematic Applications herein.

## PAD Layout

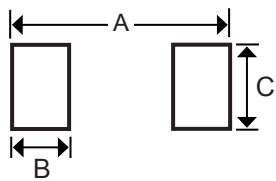

MSMBS (DO-214AA)		
	Inches	mm
A	.390	9.90
B	.110	2.79
C	.150	3.81



## MPLAD Surface-Mount Devices

Features	Appearance
<ul style="list-style-type: none"> <li>Peak pulse power at 10/1000 <math>\mu</math>S               <ul style="list-style-type: none"> <li>PLAD6.5KP series – 6.5 kW</li> <li>PLAD7.5KP series – 7.5 kW</li> <li>PLAD18KP series – 15 kW</li> <li>PLAD36KP series – 30 kW</li> </ul> </li> <li>Standoff voltage               <ul style="list-style-type: none"> <li>PLAD6.5KP – 10 V to 48 V</li> <li>PLAD7.5KP – 10 V to 48 V</li> <li>PLAD18KP – 7 V to 200 V</li> <li>PLAD36KP – 14 V to 400 V</li> </ul> </li> <li>100% surge tested devices</li> <li>Both RoHS and non-RoHS compliant versions available.</li> <li>Moisture classification is Level 1 with no dry pack required per IPC/JEDEC J-STD-020B</li> <li>Unidirectional and bidirectional versions available</li> <li>Replaces high-power through-hole devices for surface-mount applications</li> <li>Operational and storage temperature of <math>-55^{\circ}\text{C}</math> to <math>+150^{\circ}\text{C}</math></li> </ul>	 <p style="text-align: center;">PLAD</p>

## Part Nomenclature

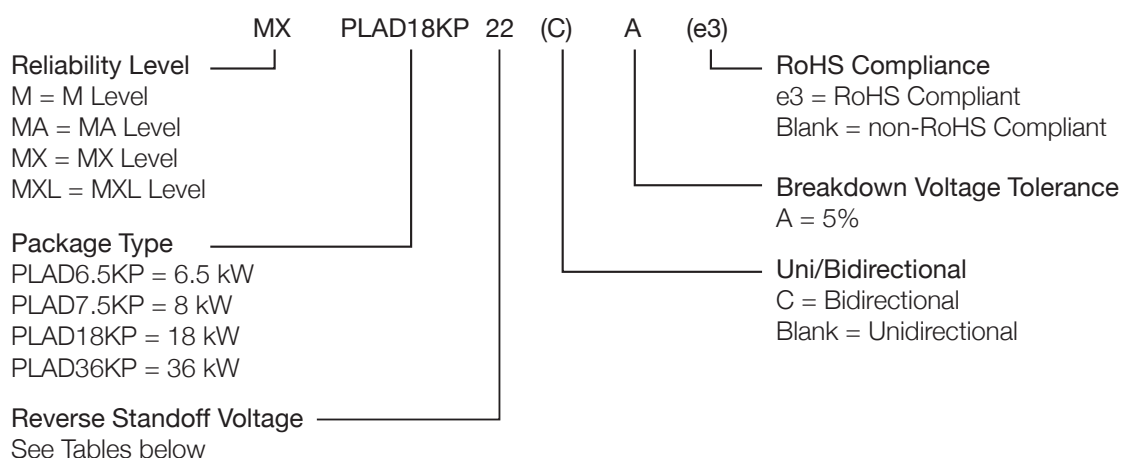

### Sample Part Number

MXPLAD18KP9.0Ae3 – MX screened 18 kW device, 9 V reverse stand-off, unidirectional, 5% tolerance and RoHS compliant

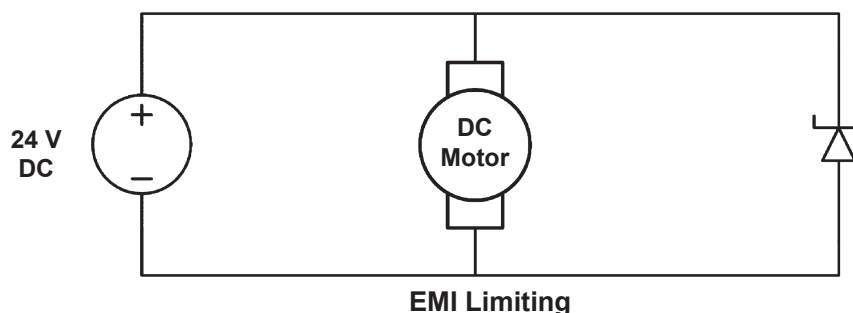

# MPLAD Surface-Mount Devices

## MPLAD6.5KP 6.5 kW, All Electrical Characteristics @ 25°C

Type Number	Reverse Stand-Off Voltage $V_{WM}$ Volts	Minimum Breakdown Voltage $V_{BR}$ Min @ $I_{BR}$ Volts	Breakdown Current $I_{BR}$ mA	Maximum Clamping Voltage @ $I_{PP}$ $V_C$ Volts	Peak Pulse Current $I_{PP}$ Amps	Maximum Standby Current @ $V_{WM}$ $I_D$ mA
MPLAD6.5KP10A	10	11.1–12.3	5	17.0	383	15
MPLAD6.5KP11A	11	12.2–13.5	5	18.2	358	10
MPLAD6.5KP12A	12	13.3–14.7	5	19.9	327	10
MPLAD6.5KP13A	13	14.4–15.9	5	21.5	302	10
MPLAD6.5KP14A	14	15.6–17.2	5	23.2	280	10
MPLAD6.5KP15A	15	16.7–18.5	5	24.4	267	10
MPLAD6.5KP16A	16	17.8–19.7	5	26.0	250	10
MPLAD6.5KP17A	17	18.9–20.9	5	27.6	236	10
MPLAD6.5KP18A	18	20.0–22.1	5	29.2	223	10
MPLAD6.5KP20A	20	22.2–24.5	5	32.4	202	10
MPLAD6.5KP22A	22	24.4–26.9	5	35.5	183	10
MPLAD6.5KP24A	24	26.7–29.5	5	38.9	167	10
MPLAD6.5KP26A	26	28.9–31.9	5	42.1	154	10
MPLAD6.5KP28A	28	31.1–34.4	5	45.5	143	10
MPLAD6.5KP30A	30	33.3–36.8	5	48.4	135	10
MPLAD6.5KP33A	33	36.7–40.6	5	53.3	123	10
MPLAD6.5KP36A	36	40.0–44.2	5	58.1	111	10
MPLAD6.5KP40A	40	44.4–49.1	5	64.5	101	10
MPLAD6.5KP43A	43	47.8–52.8	5	69.4	93	10
MPLAD6.5KP45A	45	50.0–55.3	5	72.7	89	10
MPLAD6.5KP48A	48	53.3–58.9	5	77.4	85	10

**MPLAD7.5KP 7.5 kW, All Electrical Characteristics @ 25°C**

Type Number	Reverse Stand-Off Voltage V <sub>WM</sub> Volts	Minimum Breakdown Voltage V <sub>BR</sub> Min @ I <sub>BR</sub> Volts	Breakdown Current I <sub>BR</sub> mA	Maximum Clamping Voltage @ I <sub>PP</sub> V <sub>C</sub> Volts	Peak Pulse Current I <sub>PP</sub> Amps	Maximum Standby Current @ V <sub>WM</sub> I <sub>D</sub> mA
MPLAD7.5KP10A	10	11.1–12.3	5	17.0	383	15
MPLAD7.5KP11A	11	12.2–13.5	5	18.2	358	10
MPLAD7.5KP12A	12	13.3–14.7	5	19.9	327	10
MPLAD7.5KP13A	13	14.4–15.9	5	21.5	302	10
MPLAD7.5KP14A	14	15.6–17.2	5	23.2	280	10
MPLAD7.5KP15A	15	16.7–18.5	5	24.4	267	10
MPLAD7.5KP16A	16	17.8–19.7	5	26.0	250	10
MPLAD7.5KP17A	17	18.9–20.9	5	27.6	236	10
MPLAD7.5KP18A	18	20.0–22.1	5	29.2	223	10
MPLAD7.5KP20A	20	22.2–24.5	5	32.4	202	10
MPLAD7.5KP22A	22	24.4–26.9	5	35.5	183	10
MPLAD7.5KP24A	24	26.7–29.5	5	38.9	167	10
MPLAD7.5KP26A	26	28.9–31.9	5	42.1	154	10
MPLAD7.5KP28A	28	31.1–34.4	5	45.5	143	10
MPLAD7.5KP30A	30	33.3–36.8	5	48.4	135	10
MPLAD7.5KP33A	33	36.7–40.6	5	53.3	123	10
MPLAD7.5KP36A	36	40.0–44.2	5	58.1	111	10
MPLAD7.5KP40A	40	44.4–49.1	5	64.5	101	10
MPLAD7.5KP43A	43	47.8–52.8	5	69.4	93	10
MPLAD7.5KP45A	45	50.0–55.3	5	72.7	89	10
MPLAD7.5KP48A	48	53.3–58.9	5	77.4	85	10

# MPLAD Surface-Mount Devices

## MPLAD18KP 18 kW, All Electrical Characteristics @ 25°C

Type Number	Reverse Stand-Off Voltage $V_{WM}$ Volts	Minimum Breakdown Voltage $V_{BR}$ Min. @ $I_{BR}$ Volts	Breakdown Current $I_{BR}$ mA	Maximum Clamping Voltage @ $I_{PP}$ $V_C$ Volts	Peak Pulse Current $I_{PP}$ Amps	Maximum Standby Current @ $V_{WM}$ $I_D$ $\mu A$
MPLAD18KP7.0A	7.0	7.78	150	12.0	1500	3000
MPLAD18KP7.5A	7.5	8.33	5	12.9	1396	750
MPLAD18KP8.0A	8.0	8.89	5	13.6	1324	450
MPLAD18KP8.5A	8.5	9.44	5	14.4	1250	150
MPLAD18KP9.0A	9.0	10.0	5	15.4	1169	60
MPLAD18KP10A	10	11.1	5	17.0	1059	45
MPLAD18KP11A	11	12.2	5	18.2	989	10
MPLAD18KP12A	12	13.3	5	19.9	905	10
MPLAD18KP13A	13	14.4	5	21.5	836	10
MPLAD18KP14A	14	15.6	5	23.2	776	10
MPLAD18KP15A	15	16.7	5	24.4	738	10
MPLAD18KP16A	16	17.8	5	26.0	693	10
MPLAD18KP17A	17	18.9	5	27.6	653	10
MPLAD18KP18A	18	20.0	5	29.2	617	10
MPLAD18KP20A	20	22.2	5	32.4	516	10
MPLAD18KP22A	22	24.4	5	35.5	508	10
MPLAD18KP24A	24	26.7	5	38.9	463	10
MPLAD18KP26A	26	28.9	5	42.1	428	10
MPLAD18KP28A	28	31.1	5	45.5	396	10
MPLAD18KP30A	30	33.3	5	48.4	372	10
MPLAD18KP33A	33	36.7	5	53.3	338	10
MPLAD18KP36A	36	40.0	5	58.1	310	10
MPLAD18KP40A	40	44.4	5	64.5	280	10
MPLAD18KP43A	43	47.8	5	69.4	260	10
MPLAD18KP45A	45	50.0	5	72.7	248	10
MPLAD18KP48A	48	53.3	5	77.4	233	10
MPLAD18KP51A	51	56.7	5	82.4	219	10
MPLAD18KP54A	54	60.0	5	87.1	207	10
MPLAD18KP58A	58	64.4	5	93.6	193	10
MPLAD18KP60A	60	66.7	5	96.8	186	10
MPLAD18KP64A	64	71.1	5	103	175	10
MPLAD18KP70A	70	77.8	5	113	160	10
MPLAD18KP75A	75	83.3	5	121	149	10
MPLAD18KP78A	78	86.7	5	126	143	10
MPLAD18KP85A	85	94.4	5	137	132	10
MPLAD18KP90A	90	100	5	146	124	10
MPLAD18KP100A	100	111	5	162	112	10
MPLAD18KP110A	110	122	5	177	102	10
MPLAD18KP120A	120	133	5	193	94	10
MPLAD18KP130A	130	144	5	209	87	10
MPLAD18KP150A	150	167	5	243	75	10
MPLAD18KP160A	160	178	5	259	70	10
MPLAD18KP170A	170	189	5	275	66	10
MPLAD18KP180A	180	200	5	291	62	10
MPLAD18KP200A	200	222	5	322	56	10

## MPLAD36KP 36 kW, All Electrical Characteristics @ 25°C

Type Number	Reverse Stand-Off Voltage V <sub>WM</sub> Volts	Minimum Breakdown Voltage V <sub>BR</sub> Min. @ I <sub>BR</sub> Volts	Breakdown Current I <sub>BR</sub> mA	Maximum Clamping Voltage @ I <sub>PP</sub> V <sub>C</sub> Volts	Peak Pulse Current I <sub>PP</sub> Amps	Maximum Standby Current @ V <sub>WM</sub> I <sub>D</sub> µA
MPLAD36KP14A MPLAD36KP15A	14 15	15.6 16.7	150 5	24.0 25.8	1500 1396	3000 750
MPLAD36KP16A MPLAD36KP17A	16 17	17.8 18.9	5 5	27.2 28.8	1324 1250	450 150
MPLAD36KP18A MPLAD36KP20A	18 20	20.0 22.2	5 5	30.8 34.0	1169 1059	60 45
MPLAD36KP22A MPLAD36KP24A	22 24	24.4 26.7	5 5	36.4 39.8	990 905	10 10
MPLAD36KP26A MPLAD36KP28A	26 28	28.9 31.1	5 5	43.0 46.4	838 776	10 10
MPLAD36KP30A MPLAD36KP33A	30 33	33.3 36.7	5 5	48.8 53.3	738 676	10 10
MPLAD36KP36A MPLAD36KP40A	36 40	40.0 44.4	5 5	58.1 64.5	620 559	10 10
MPLAD36KP43A MPLAD36KP45A	43 45	47.8 50.0	5 5	69.4 72.7	519 496	10 10
MPLAD36KP48A MPLAD36KP51A	48 51	53.3 56.7	5 5	77.4 82.4	466 437	10 10
MPLAD36KP54A MPLAD36KP58A	54 58	60.0 64.4	5 5	87.1 93.6	414 385	10 10
MPLAD36KP60A MPLAD36KP64A	60 64	66.7 71.1	5 5	96.8 103.0	372 350	10 10
MPLAD36KP70A MPLAD36KP75A	70 75	77.8 83.3	5 5	113 121	319 298	10 10
MPLAD36KP78A MPLAD36KP85A	78 85	86.7 94.4	5 5	126 137	286 263	10 10
MPLAD36KP90A MPLAD36KP100A	90 100	100 111	5 5	146 162	247 223	10 10
MPLAD36KP110A MPLAD36KP120A	110 120	122 133	5 5	177 193	204 187	10 10
MPLAD36KP130A MPLAD36KP150A	130 150	144 167	5 5	209 243	173 149	10 10
MPLAD36KP160A MPLAD36KP170A	160 170	178 189	5 5	259 275	139 131	10 10
MPLAD36KP180A MPLAD36KP200A	180 200	200 222	5 5	291 322	124 112	10 10
MPLAD36KP220A MPLAD36KP260A	220 260	245 289	5 5	356 419	102 86	10 10
MPLAD36KP280A MPLAD36KP300A	280 300	311 333	5 5	451 483	80 75	10 10
MPLAD36KP350A MPLAD36KP400A	350 400	389 444	5 5	564 644	64 56	10 10

# MP4KE/MP6KE/M1.5KE Axial Devices

## KE Axial Devices

Features	Appearance
<ul style="list-style-type: none"> <li>Peak pulse power at 10/1000 <math>\mu</math>S                             <ul style="list-style-type: none"> <li>P4KE series – 400 W</li> <li>P6KE series – 600 W</li> <li>1.5KE series – 1.5 kW</li> </ul> </li> <li>Standoff voltage                             <ul style="list-style-type: none"> <li>P4KE series – 5.8 V to 342 V</li> <li>P6KE series – 5.8 V to 171 V</li> <li>1.5KE series – 5.8 V to 324 V</li> </ul> </li> <li>100% surge-tested devices</li> <li>Both RoHS and non-RoHS compliant versions available.</li> <li>Moisture classification is Level 1 with no dry pack required per IPC/JEDEC J-STD-020B</li> <li>Unidirectional and bidirectional versions available</li> <li>Replaces high-power through-hole devices for surface-mount applications</li> <li>Operational and storage temperature of <math>-55^{\circ}\text{C}</math> to <math>+150^{\circ}\text{C}</math></li> </ul>	

## Part Nomenclature

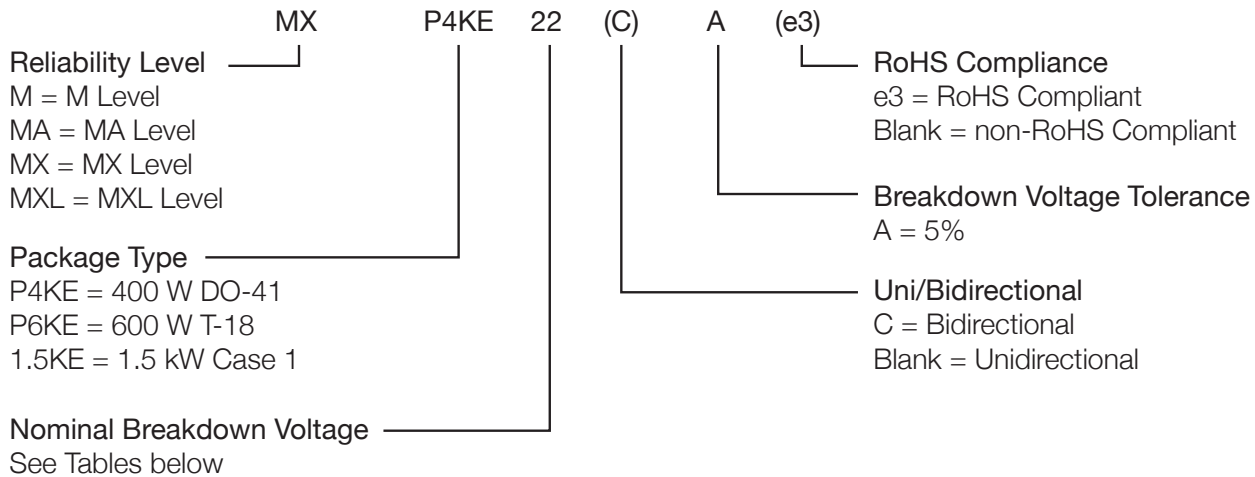

### Sample Part Number

MA1.5KE27Ae3 – MA screened 1.5 KE 15 kW device, 27 V breakdown, unidirectional, 5% tolerance and RoHS compliant.

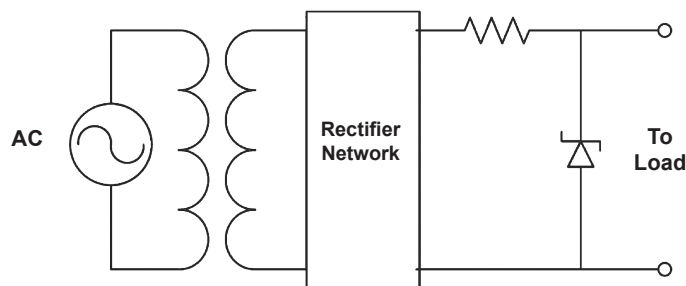

DC Line Protection

**MP4KE 400 W, All Electrical Characteristics @ 25°C**

Type Number	Reverse Stand-Off Voltage V <sub>WM</sub> Volts	Minimum Breakdown Voltage V <sub>BR</sub> Min. @ I <sub>BR</sub> Volts	Breakdown Current I <sub>BR</sub> mA	Maximum Clamping Voltage @ I <sub>PP</sub> V <sub>C</sub> Volts	Peak Pulse Current I <sub>PP</sub> Amps	Maximum Standby Current @ V <sub>WM</sub> I <sub>D</sub> μA
MP4KE6.8A	5.80	6.45	10	10.5	38	500
MP4KE7.5A	6.40	7.13	10	11.3	35	200
MP4KE8.2A	7.02	7.79	10	12.1	33	100
MP4KE9.1A	7.78	8.65	1	13.4	30	20
MP4KE10A	8.55	9.50	1	14.5	28	5
MP4KE11A	9.40	10.5	1	15.6	26	2
MP4KE12A	10.2	11.4	1	16.7	24	1
MP4KE13A	11.1	12.4	1	18.2	22	1
MP4KE15A	12.8	14.3	1	21.2	19	1
MP4KE16A	13.6	15.2	1	22.5	18	1
MP4KE18A	15.3	17.1	1	25.2	16	1
MP4KE20A	17.1	19.0	1	27.7	14.5	1
MP4KE22A	18.8	20.9	1	30.6	13	1
MP4KE24A	20.5	22.8	1	33.2	12	1
MP4KE27A	23.1	25.7	1	37.5	11	1
MP4KE30A	25.6	28.5	1	41.4	9.5	1
MP4KE33A	28.2	31.4	1	45.7	9.0	1
MP4KE36A	30.8	34.2	1	49.9	8.0	1
MP4KE39A	33.3	37.1	1	53.9	7.5	1
MP4KE43A	36.8	40.9	1	59.3	7.0	1
MP4KE47A	40.2	44.7	1	64.8	6.2	1
MP4KE51A	43.6	48.5	1	70.1	5.7	1
MP4KE56A	47.8	53.2	1	77.0	5.2	1
MP4KE62A	53.0	58.9	1	85.0	4.7	1
MP4KE68A	58.1	64.6	1	92.0	4.4	1
MP4KE75A	64.1	71.3	1	103.0	3.9	1
MP4KE82A	70.1	77.9	1	113.0	3.5	1
MP4KE91A	77.8	86.5	1	125.0	3.2	1
MP4KE100A	85.5	95.0	1	137.0	2.9	1
MP4KE110A	94.0	105.0	1	152.0	2.6	1
MP4KE120A	102.0	114.0	1	165.0	2.4	1
MP4KE130A	111.0	124.0	1	179.0	2.2	1
MP4KE150A	128.0	143.0	1	207.0	1.95	1
MP4KE160A	136.0	152.0	1	219.0	1.8	1
MP4KE170A	145.0	162.0	1	234.0	1.7	1
MP4KE180A	154.0	171.0	1	246.0	1.6	1
MP4KE200A	171.0	190.0	1	274.0	1.5	1
MP4KE220A	185.0	209.0	1	328.0	1.0	1
MP4KE250A	214.0	237.0	1	344.0	1.0	1
MP4KE300A	256.0	285.0	1	414.0	1.0	1
MP4KE350A	300.0	333.0	1	482.0	1.0	1
MP4KE400A	342.0	380.0	1	548.0	1.0	1



# MP4KE/MP6KE/1.5KE Axial Devices

## MP6KE 600 W, All Electrical Characteristics @ 25°C

Type Number	Reverse Stand-Off Voltage $V_{WM}$ Volts	Minimum Breakdown Voltage $V_{BR}$ Min. @ $I_{BR}$ Volts	Breakdown Current $I_{BR}$ mA	Maximum Clamping Voltage @ $I_{PP}$ $V_C$ Volts	Peak Pulse Current $I_{PP}$ Amps	Maximum Standby Current @ $V_{WM}$ $I_D$ $\mu A$
MP6KE6.8A MP6KE7.5A	5.8 6.4	6.45 7.13	10 10	10.5 11.3	57 53	1000 500
MP6KE8.2A MP6KE9.1A	7.02 7.78	7.79 8.65	10 1	12.1 13.4	50 45	200 50
MP6KE10A MP6KE11A	8.55 9.4	9.5 10.5	1 1	14.5 15.6	41 38	10 5
MP6KE12A MP6KE13A	10.2 11.1	11.4 12.4	1 1	16.7 18.2	36 33	5 5
MP6KE15A MP6KE16A	12.8 13.6	14.3 15.2	1 1	21.2 22.5	28 27	1 1
MP6KE18A MP6KE20A	15.3 17.1	17.1 19	1 1	25.2 27.7	24 22	1 1
MP6KE22A MP6KE24A	18.8 20.5	20.9 22.8	1 1	30.6 33.2	20 18	1 1
MP6KE27A MP6KE30A	23.1 25.6	25.7 28.5	1 1	37.5 41.4	16 14.4	1 1
MP6KE33A MP6KE36A	28.2 30.8	31.4 34.2	1 1	45.7 49.9	13.2 12	1 1
MP6KE39A MP6KE43A	33.3 36.8	37.1 40.9	1 1	53.9 59.3	11.2 10.1	1 1
MP6KE47A MP6KE51A	40.2 43.6	44.7 48.5	1 1	64.8 70.1	9.3 8.6	1 1
MP6KE56A MP6KE62A	47.8 53	53.2 58.9	1 1	77 85	7.8 7.1	1 1
MP6KE68A MP6KE75A	58.1 64.1	64.6 71.3	1 1	92 103	6.5 5.8	1 1
MP6KE82A MP6KE91A	70.1 77.8	77.9 86.5	1 1	113 125	5.3 4.8	1 1
MP6KE100A MP6KE110A	85.5 94	95 105	1 1	137 152	4.4 3.4	1 1
MP6KE120A MP6KE130A	102 111	114 124	1 1	165 179	3.6 3.3	1 1
MP6KE150A MP6KE160A	128 136	143 152	1 1	207 219	2.9 2.7	1 1
MP6KE170A MP6KE180A	145 154	161 171	1 1	234 246	2.6 2.4	1 1
MP6KE200A	171	190	1	274	2.2	1

**M1.5KE 1.5kW, All Electrical Characteristics @ 25°C**

Type Number	Reverse Stand-Off Voltage $V_{WM}$ Volts	Minimum Breakdown Voltage $V_{BR}$ Min @ $I_{BR}$ Volts	Breakdown Current $I_{BR}$ mA	Maximum Clamping Voltage @ $I_{PP}$ $V_C$ Volts	Peak Pulse Current $I_{PP}$ Amps	Maximum Standby Current @ $V_{WM}$ $I_D$ $\mu A$
M1.5KE6.8A M1.5KE7.5A	5.80 6.40	6.45 7.13	10 10	10.5 11.3	143.0 132.0	1000 500
M1.5KE8.2A M1.5KE9.1A	7.02 7.78	7.79 8.65	10 1	12.1 13.4	124.0 112.0	200 50
M1.5KE10A M1.5KE11A	8.55 9.40	9.50 10.50	1 1	14.5 15.6	103.0 96.0	10 5
M1.5KE12A M1.5KE13A	10.220 11.10	11.40 12.40	1 1	16.7 18.2	90.0 82.0	5 5
M1.5KE15A M1.5KE16A	12.80 13.60	14.30 15.20	1 1	21.2 22.5	71.0 67.0	1 1
M1.5KE18A M1.5KE20A	15.30 17.10	17.10 19.00	1 1	25.2 27.7	59.5 54.0	1 1
M1.5KE22A M1.5KE24A	18.80 20.50	20.90 22.80	1 1	30.6 33.2	49.0 45.0	1 1
M1.5KE27A M1.5KE30A	23.10 25.60	25.70 28.50	1 1	37.5 41.4	40.0 36.0	1 1
M1.5KE33A M1.5KE36A	28.20 30.80	31.40 34.20	1 1	45.7 49.9	33.0 30.0	1 1
M1.5KE39A M1.5KE43A	33.30 36.80	37.10 40.90	1 1	53.9 59.3	28.0 25.3	1
M1.5KE47A M1.5KE51A	40.20 43.60	44.70 48.50	1 1	64.8 70.1	23.2 21.4	1 1
M1.5KE56A M1.5KE62A	47.80 53.00	53.20 58.90	1 1	77.0 85.0	19.5 17.7	1 1
M1.5KE68A M1.5KE75A	58.10 64.10	64.60 71.30	1 1	92.0 103.0	16.3 14.6	1 1
M1.5KE82A M1.5KE91A	70.10 77.80	77.90 86.50	1 1	113.0 125.0	13.3 12.0	1 1
M1.5KE100A M1.5KE110A	85.50 94.00	95.00 105.00	1 1	137.0 152.0	11.0 9.9	1 1
M1.5KE120A M1.5KE130A	102.00 111.00	114.00 124.00	1 1	165.0 179.0	9.1 8.4	1 1
M1.5KE150A M1.5KE160A	128.00 136.00	143.00 152.00	1 1	207.0 219.0	7.2 6.8	1 1
M1.5KE170A M1.5KE180A	145.00 154.00	162.00 171.00	1 1	234.0 246.0	6.4 6.1	1 1
M1.5KE200A M1.5KE220A	171.00 185.00	190.00 209.00	1 1	274.0 328.0	5.5 4.6	1 1
M1.5KE250A M1.5KE300A	214.00 256.00	237.00 285.00	1 1	344.0 414.0	5.0 5.0	1 1
M1.5KE350A M1.5KE400A	300.00 324.00	332.00 380.00	1 1	482.0 548.0	4.0 4.0	1 1

# MLCE Low-Capacitance Axial Devices

## MLCE Axial Devices

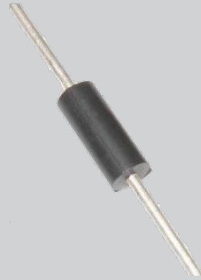
Features	Appearance
<ul style="list-style-type: none"> <li>• 1.5 kW peak pulse power at 10/1000 <math>\mu</math>S</li> <li>• Standoff voltage of 6.5 V to 170 V</li> <li>• Operational and storage temperature of <math>-55^{\circ}\text{C}</math> to <math>+150^{\circ}\text{C}</math></li> <li>• Low-capacitance performance <math>\leq 100</math> pF</li> <li>• 100% surge-tested devices</li> <li>• Both RoHS and non-RoHS compliant versions available.</li> <li>• Moisture classification is Level 1 with no dry pack required per IPC/JEDEC J-STD-020B</li> </ul>	

## Part Nomenclature

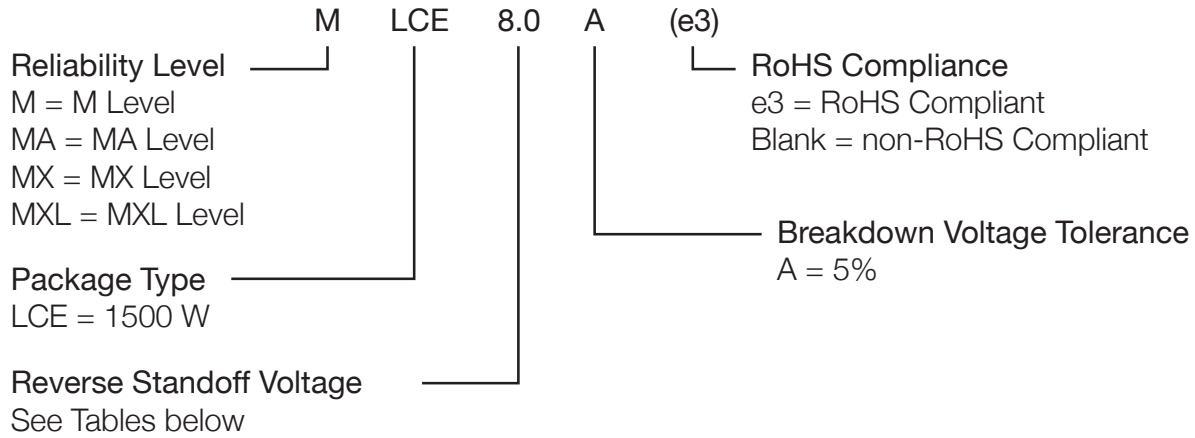

### Sample Part Number

**MALCE48A** – MA screened axial Low Capacitance 1.5 kW device, 48 V stand-off, unidirectional with 5% tolerance

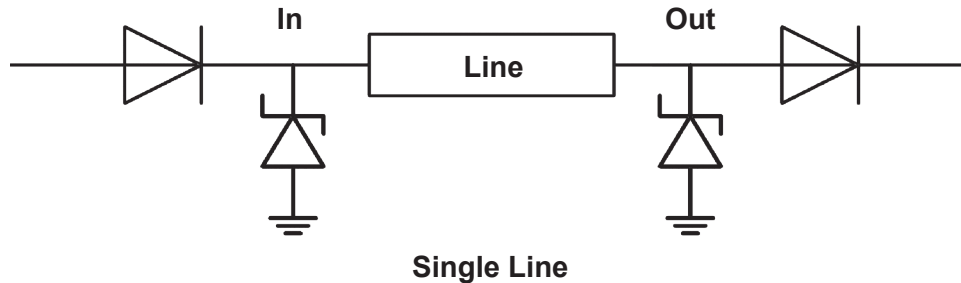

## MLCE 1.5 kW, All Electrical Characteristics @ 25°C

Type Number	Reverse Stand-Off Voltage $V_{WM}$ Volts	Minimum Breakdown Voltage $V_{BR}$ Min @ $I_{BR}$ Volts	Breakdown Current $I_{BR}$ mA	Maximum Clamping Voltage @ $I_{PP}$ $V_C$ Volts	Peak Pulse Current $I_{PP}$ Amps	Maximum Standby Current $I_D$ @ $V_{WM}$ $\mu A$	Max Cap @ 0 Volts $F=1$ MHz pF	Working Inverse Blocking Voltage $V_{WIB}$ @ $V_{WIB}$ Volts	Inverse Blocking Leakage Current $I_{IB}$ @ $V_{WIB}$ $\mu A$	Peak Inverse Blocking Voltage $V_{PIB}$ Volts
MLCE6.5A	6.5	7.22	10	11.2	100	1000	100	75	10	100
MLCE7.0A	7.0	7.78	10	12.0	100	500	100	75	10	100
MLCE7.5A	7.5	8.33	10	12.9	100	250	100	75	10	100
MLCE8.0A	8.0	8.89	1	13.6	100	100	100	75	10	100
MLCE8.5A	8.5	9.44	1	14.4	100	50	100	75	10	100
MLCE9.0A	9.0	10.0	1	15.4	97	10	100	75	10	100
MLCE10A	10	11.1	1	17.0	88	5	100	75	10	100
MLCE11A	11	12.2	1	18.2	82	5	100	75	10	100
MLCE12A	12	13.3	1	19.9	75	5	100	75	10	100
MLCE13A	13	14.4	1	21.5	70	5	100	75	10	100
MLCE14A	14	15.6	1	23.2	65	5	100	75	10	100
MLCE15A	15	16.7	1	24.4	61	5	100	75	10	100
MLCE16A	16	17.8	1	26.0	57	5	100	75	10	100
MLCE17A	17	18.9	1	27.6	54	5	100	75	10	100
MLCE18A	18	20.0	1	29.2	51	5	100	75	10	100
MLCE20A	20	22.2	1	32.4	46	5	100	75	10	100
MLCE22A	22	24.4	1	35.5	42	5	100	75	10	100
MLCE24A	24	26.7	1	38.9	39	5	100	75	10	100
MLCE26A	26	28.9	1	42.1	36	5	100	75	10	100
MLCE28A	28	31.1	1	45.4	33	5	100	75	10	100
MLCE30A	30	33.3	1	48.4	31	5	100	75	10	100
MLCE33A	33	36.7	1	53.3	28.1	5	100	75	10	100
MLCE36A	36	40.0	1	58.1	25.8	5	100	75	10	100
MLCE40A	40	44.4	1	64.5	23.3	5	100	75	10	100
MLCE43A	43	47.8	1	69.4	21.6	5	100	150	10	200
MLCE45A	45	50.0	1	72.7	20.6	5	100	150	10	200
MLCE48A	48	53.3	1	77.4	19.4	5	100	150	10	200
MLCE51A	51	56.7	1	82.4	18.2	5	100	150	10	200
MLCE54A	54	60.0	1	87.1	17.2	5	100	150	10	200
MLCE58A	58	64.4	1	93.6	16.0	5	100	150	10	200
MLCE60A	60	66.7	1	96.8	15.5	5	90	150	10	200
MLCE64A	64	71.1	1	103	14.6	5	90	150	10	200
MLCE70A	70	77.8	1	113	13.3	5	90	150	10	200
MLCE75A	75	83.3	1	121	12.4	5	90	150	10	200
MLCE80A	80	88.7	1	129	11.6	5	90	150	10	200
MLCE90A	90	100	1	146	10.3	5	90	300	10	200
MLCE100A	100	111	1	162	9.3	5	90	300	10	200
MLCE110A	110	122	1	178	8.4	5	90	300	10	400
MLCE120A	120	133	1	193	7.8	5	90	300	10	400
MLCE130A	130	144	1	209	7.2	5	90	300	10	400
MLCE150A	150	167	1	243	6.2	5	90	300	10	400
MLCE160A	160	178	1	259	5.8	5	90	300	10	400
MLCE170A	170	189	1	275	5.4	5	90	300	10	400

## M5KP/M15KP Axial Devices

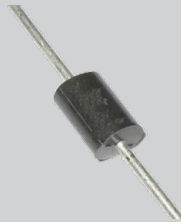
Features	Appearance
<ul style="list-style-type: none"> <li>Peak pulse power at 10/1000 <math>\mu</math>S                             <ul style="list-style-type: none"> <li>5 KP series – 5 kW</li> <li>15 KP series – 15 kW</li> </ul> </li> <li>Standoff voltage                             <ul style="list-style-type: none"> <li>5 KP series – 5 V to 110 V</li> <li>15 KP series – 22 V to 280 V</li> </ul> </li> <li>Operational and storage temperature of <math>-55^{\circ}\text{C}</math> to <math>+150^{\circ}\text{C}</math></li> <li>Unidirectional and bidirectional versions available</li> <li>Both RoHS and non-RoHS compliant versions available.</li> <li>Moisture classification is Level 1 with no dry pack required per IPC/JEDEC J-STD-020B</li> <li>100% surge-tested devices</li> </ul>	

## Part Nomenclature

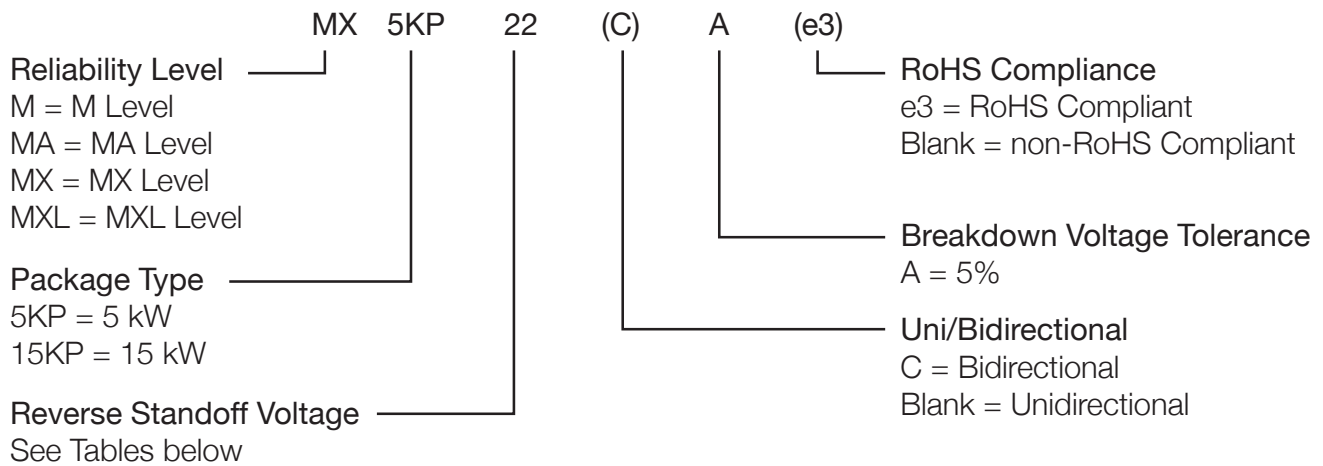

### Sample Part Number

**MA5KP36Ae3** – MA screened axial 5 kW device, 36 V reverse stand-off, unidirectional, 5% tolerance and RoHS compliant

**MXL15KPA40CA** – MXL screened axial 15 kW device, 40 V breakdown, bidirectional, 5% tolerance and non-RoHS compliant

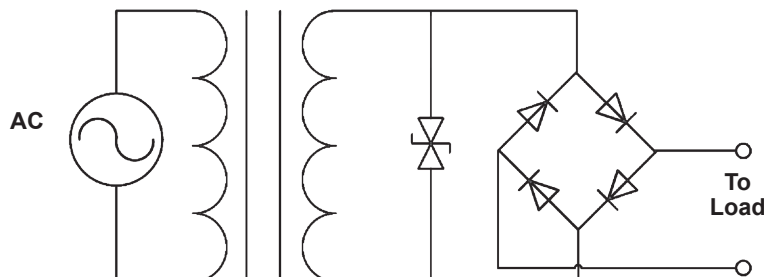

AC Supply Protection

**M5KP 5kW, All Electrical Characteristics @ 25°C**

Type Number	Reverse Stand-Off Voltage $V_{WM}$ Volts	Minimum Breakdown Voltage $V_{BR}$ Min @ $I_{BR}$ Volts	Breakdown Current $I_{BR}$ mA	Maximum Clamping Voltage @ $I_{PP}$ $V_c$ Volts	Peak Pulse Current $I_{PP}$ Amps	Maximum Standby Current @ $V_{WM}$ $I_d$ $\mu A$
M5KP5.0A M5KP6.0A	5.0 6.0	6.40 6.67	50 50	9.2 10.3	543 485	2000* 5000
M5KP6.5A M5KP7.0A	6.5 7.0	7.22 7.78	50 50	11.2 12.0	447 417	2000 1000
M5KP7.5A M5KP8.0A	7.5 8.0	8.33 8.89	5 5	12.9 13.6	388 367	250 150
M5KP8.5A M5KP9.0A	8.5 9.0	9.44 10.0	5 5	14.4 15.4	347 325	50 20
M5KP10A M5KP11A	10 11	11.1 12.2	5 5	17.0 18.2	294 274	15 10
M5KP12A M5KP13A	12 13	13.3 14.4	5 5	19.9 21.5	251 232	10 10
M5KP14A M5KP15A	14 15	15.6 16.7	5 5	23.2 24.4	215 206	10 10
M5KP16A M5KP17A	16 17	17.8 18.9	5 5	26.0 27.6	192 181	10 10
M5KP18A M5KP20A	18 20	20.0 22.2	5 5	29.2 32.4	172 154	10 10
M5KP22A M5KP24A	22 24	24.4 26.7	5 5	35.5 38.9	141 128	10 10
M5KP26A M5KP28A	26 28	28.9 31.1	5 5	42.1 45.5	119 110	10 10
M5KP30A M5KP33A	30 33	33.3 36.7	5 5	48.4 53.3	103 94	10 10
M5KP36A M5KP40A	36 40	40.0 44.4	5 5	58.1 64.5	86 78	10 10
M5KP43A M5KP45A	43 45	47.8 50.0	5 5	69.4 72.7	72 69	10 10
M5KP48A M5KP51A	48 51	53.3 56.7	5 5	77.4 82.4	65 61	10 10
M5KP54A M5KP58A	54 58	60.0 64.4	5 5	87.1 93.6	57 53	10 10
M5KP60A M5KP64A	60 64	66.7 71.1	5 5	96.8 103.0	52 49	10 10
M5KP70A M5KP75A	70 75	77.8 83.3	5 5	113 121	44 41	10 10
M5KP78A M5KP85A	78 85	86.7 94.4	5 5	126 137	40 36	10 10
M5KP90A M5KP100A	90 100	100 111	5 5	146 162	34 31	10 10
M5KP110A	110	122	5	177	28	10

# M5KP/M15KP Axial Devices

## M15KP 15 kW, All Electrical Characteristics @ 25°C

Type Number	Reverse Stand-Off Voltage $V_{WM}$ Volts	Minimum Breakdown Voltage $V_{BR}$ Min @ $I_{BR}$ Volts	Breakdown Current $I_{BR}$ mA	Maximum Clamping Voltage @ $I_{PP}$ $V_C$ Volts	Peak Pulse Current $I_{PP}$ Amps	Maximum Standby Current @ $V_{WM}$ $I_D$ $\mu A$
M15KP22A	22	24.4	10	37.1	404	500
M15KP24A	24	26.7	5	40.7	369	150
M15KP26A	26	28.9	5	44.0	341	50
M15KP28A	28	31.1	5	47.5	316	25
M15KP30A	30	33.3	5	50.7	296	15
M15KP33A	33	36.7	5	54.8	274	10
M15KP36A	36	40.0	5	59.7	251	10
M15KP40A	40	44.4	5	65.8	228	10
M15KP43A	43	47.8	5	69.7	215	10
M15KP45A	45	50.0	5	73.0	205	10
M15KP48A	48	53.3	5	77.7	193	10
M15KP51A	51	56.7	5	82.8	181	10
M15KP54A	54	60.0	5	87.5	171	10
M15KP58A	58	64.4	5	94.0	160	10
M15KP60A	60	66.7	5	97.3	154	10
M15KP64A	64	71.7	5	104	144	10
M15KP70A	70	77.8	5	114	132	10
M15KP75A	75	83.3	5	122	123	10
M15KP78A	78	86.7	5	126	119	10
M15KP85A	85	94.4	5	137	109	10
M15KP90A	90	100	5	146	103	10
M15KP100A	100	111	5	162	93	10
M15KP110A	110	122	5	178	84	10
M15KP120A	120	133	5	193	78	10
M15KP130A	130	144	5	209	72	10
M15KP150A	150	167	5	243	62	10
M15KP160A	160	178	5	259	58	10
M15KP170A	170	189	5	275	55	10
M15KP180A	180	200	5	291	52	10
M15KP200A	200	222	5	322	47	10
M15KP220A	220	245	5	356	42	10
M15KP240A	240	267	5	388	39	10
M15KP260A	260	289	5	419	36	10
M15KP280A	280	311	5	452	33	10

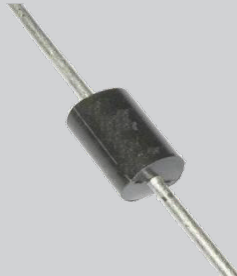

**MRT100KP Axial Devices**

Features	Appearance
<ul style="list-style-type: none"> <li>• 100 kW peak pulse power at 6.4/69 <math>\mu</math>S</li> <li>• Standoff voltage of 40V to 400V</li> <li>• Operational and storage temperature of <math>-55^{\circ}\text{C}</math> to <math>+150^{\circ}\text{C}</math></li> <li>• Unidirectional and bidirectional versions available</li> <li>• 100% surge-tested devices</li> <li>• Both RoHS and non-RoHS compliant versions available.</li> <li>• Moisture classification is Level 1 with no dry pack required per IPC/JEDEC J-STD-020B</li> </ul>	

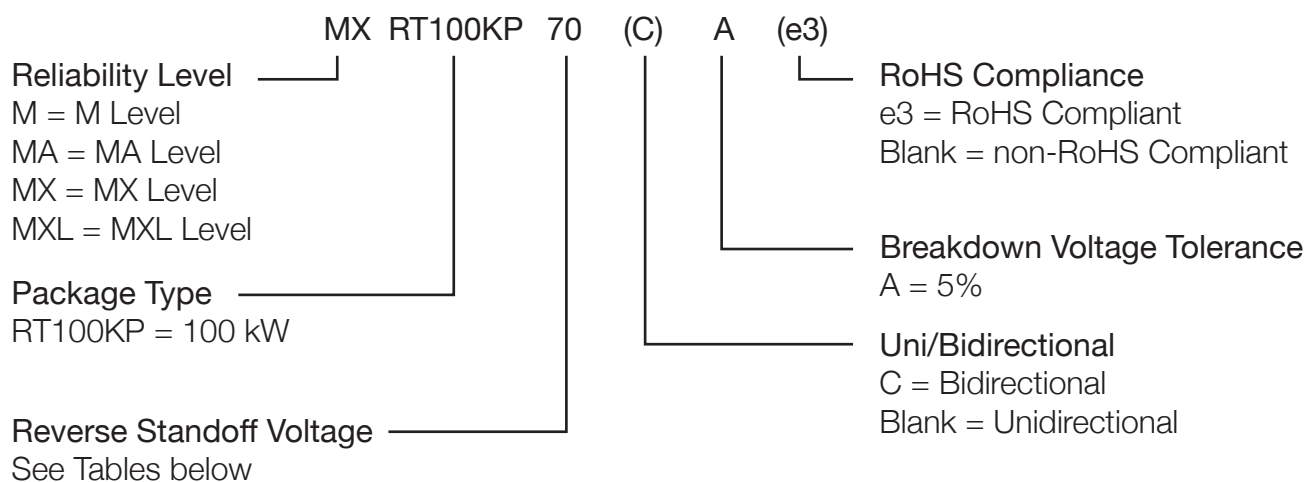
**Part Nomenclature**

**Sample Part Number**

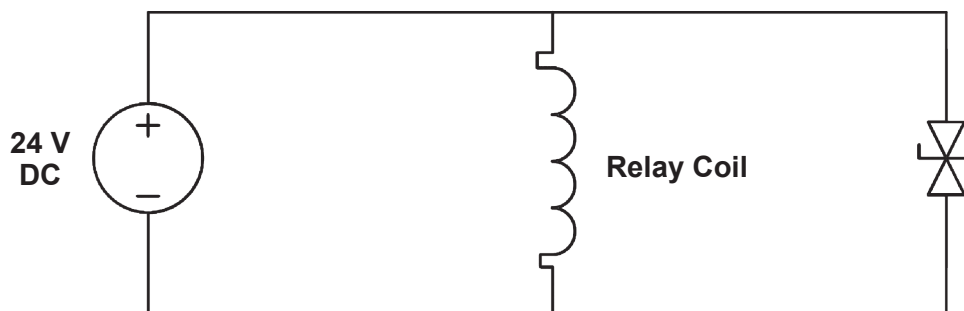
**MXRT100KP70CAe3** – MX screened axial 100 kW device, 70 V stand-off, bidirectional, 5% tolerance and RoHS compliant.

**Relay Transient Protection**

# MRT100KP Axial Devices

## MRT100KP 100 kW @ 6.4/69 $\mu$ S, All Electrical Characteristics @ 25°C

Type Number	Reverse Stand-Off Voltage $V_{WM}$ Volts	Minimum Breakdown Voltage $V_{BR}$ Min. @ $I_{BR}$ Volts	Breakdown Current $I_{BR}$ mA	Maximum Clamping Voltage @ $I_{PP}$ $V_C$ Volts	Peak Pulse Current $I_{PP}$ Amps	Maximum Standby Current @ $V_{WM}$ $I_D$ $\mu$ A
MRT100KP40A	40	44.4	20	78.6	1273*	1500
MRT100KP43A	43	47.8	10	84.5	1184 *	500
MRT100KP45A	45	50.0	5	88.5	1130 *	150
MRT100KP48A	48	53.3	5	94.3	1061 *	150
MRT100KP51A	51	56.7	5	101	990 *	50
MRT100KP54A	54	60.0	5	106	943 *	25
MRT100KP58A	58	64.4	5	114	878	15
MRT100KP60A	60	66.7	5	118	848	15
MRT100KP64A	64	71.1	5	126	795	10
MRT100KP70A	70	77.8	5	138	725	10
MRT100KP75A	75	83.3	5	147	680	10
MRT100KP78A	78	86.7	5	153	655	10
MRT100KP85A	85	94.4	5	166	602	10
MRT100KP90A	90	100	5	178	563	10
MRT100KP100A	100	111	5	197	508	10
MRT100KP110A	110	122	5	216	463	10
MRT100KP120A	120	133	5	235	426	10
MRT100KP130A	130	144	5	254	394	10
MRT100KP150A	150	167	5	296	338	10
MRT100KP160A	160	178	5	315	318	10
MRT100KP170A	170	189	5	334	300	10
MRT100KP180A	180	200	5	354	283	10
MRT100KP200A	200	222	5	392	256	10
MRT100KP220A	220	245	5	434	231	10
MRT100KP250A	250	278	5	493	203	10
MRT100KP260A	260	289	5	512	196	10
MRT100KP280A	280	311	5	552	181	10
MRT100KP300A	300	333	5	590	170	10
MRT100KP350A	350	389	5	690	145	10
MRT100KP400A	400	444	5	787	127	10

\*The Maximum Peak Pulse Current ( $I_{PP}$ ) shown represents the performance capabilities by design. Surge test screening is only performed up to 900 Amps (test equipment limitations).

## MRT130KP 130 kW Transient Voltage Suppressor

### Features

- Operational and storage temperature of  $-55\text{ }^{\circ}\text{C}$  to  $+150\text{ }^{\circ}\text{C}$
- 100% surge-tested devices
- Suppresses transients up to 130 kW @ 6.4/69  $\mu\text{s}$
- Available as either low clamp with “CV” suffix or normal clamping features with “CA” suffix
- Moisture classification is Level 1 with no dry pack required per IPC/JEDEC J-STD-020B
- RoHS compliant devices available by adding “e3” suffix

### Electrical Characteristics @ 25°C

Part Number	Working Standoff Voltage $V_{WM}$	Maximum Standby Current $I_D$ @ $V_{WM}$	Minimum Breakdown Voltage $V_{BR}$ @ $I_{BR}$	Breakdown Current $I_{BR}$	Maximum Clamping Voltage $V_C$ @ $I_{PP}$ (Note 1)	Peak Pulse Current $I_{PP}$ @ 6.4/69 $\mu\text{s}$ (Note 2)
	V Max	$\mu\text{A}$	Volts	mA	Volts	Amps
MRT130KP275CV	275	5	300	5	400	292
MRT130KP275CA	275	5	300	5	445	292
MRT130KP295CV	295	5	300	5	410	282
MRT130KP295CA	295	5	300	5	460	282

# MRT65KP Transient Voltage Suppressor

## MRT65KP 65 kW Transient Voltage Suppressor

### Features

- 100% surge-tested devices
- Suppresses transients up to 65 kW @ 6.4/69  $\mu$ s
- Operational and storage temperature of  $-55^{\circ}\text{C}$  to  $+150^{\circ}\text{C}$
- Moisture classification is Level 1 with no dry pack required per IPC/JEDEC J-STD-020B
- RoHS compliant devices available by adding “e3” suffix

### Electrical Characteristics @ 25°C

PART NUMBER (replace A suffix with CA for bidirectional)	Working Standoff Voltage $V_{WM}$	Maximum Standby Current $I_D @ V_{WM}$	Minimum Breakdown Voltage $V_{BR} @ I_{BR}$	Breakdown Current $I_{BR}$	Maximum Clamping Voltage $V_C @ I_{PP}$ (Note 1)	Peak Pulse Current $I_{PP} @ 6.4/69 \mu\text{S}$ (Note 2)
	V max	$\mu\text{A}$	V	mA	V	A
MRT65KP48A	48	5	53.3	5	77.7	836
MRT65KP54A	54	5	60.0	5	87.5	742
MRT65KP60A	60	5	66.7	5	97.3	668
MRT65KP75A	75	5	83.3	5	122	533

## MDA 3 kW Transient Voltage Suppressor Array

Features
<ul style="list-style-type: none"> <li>Available in both unidirectional and bidirectional construction</li> <li>Selections for 6.0 to 40 Volts Standoff Voltages (VWM)</li> <li>Operational and storage temperature of -55°C to +150°C</li> <li>RoHS compliant devices available by adding "e3" suffix</li> <li>Suppresses transients up to 3,000 W @ 10/1000 <math>\mu</math>s</li> <li>Moisture classification is Level 1 with no dry pack required per IPC/JEDEC J-STD-020B</li> <li>100% surge-tested devices</li> </ul>

### Part Nomenclature

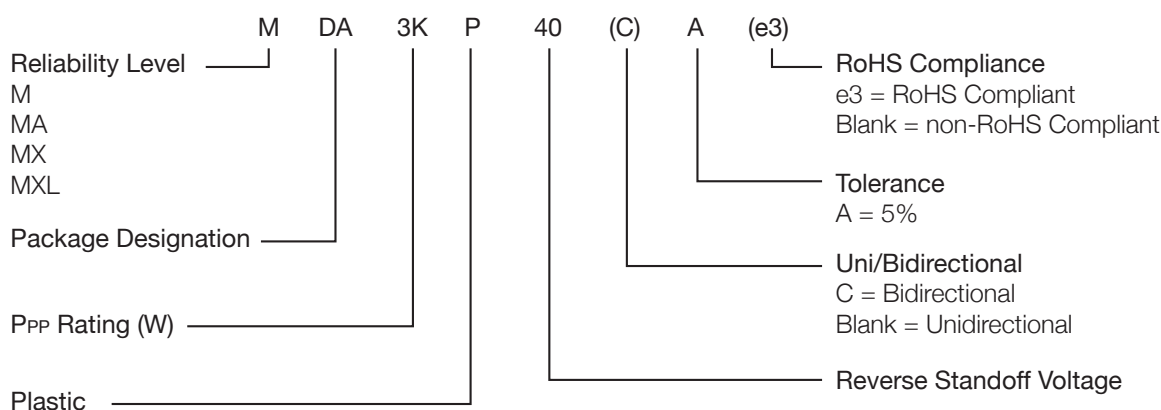

Part Number	Reverse Stand off Voltage V <sub>WM</sub>	Breakdown Voltage		Maximum Clamping Voltage V <sub>c</sub> @ I <sub>PP</sub>	Maximum Standby Current ID @ V <sub>WM</sub>	Maximum Peak Pulse Current I <sub>PP</sub>
		V <sub>(br)</sub> (Min-Max)	@ I <sub>(br)</sub>			
		V	mA			
MDA3KP6.0A	6	6.67–7.37	10	10.3	1000	291.3
MDA3KP6.5A	6.5	7.22–7.98	10	11.2	500	267.9
MDA3KP7.0A	7	7.78–8.6	10	12.0	200	250
MDA3KP7.5A	7.5	8.33–9.21	1	12.9	100	232.6
MDA3KP8.0A	8	8.89–9.83	1	13.6	50	220.6
MDA3KP8.5A	8.5	9.44–10.4	1	14.4	25	208.3
MDA3KP9.0A	9	10.0–11.1	1	15.4	10	194.8
MDA3KP10A	10	11.1–12.3	1	17.0	5	176.5
MDA3KP11A	11	12.2–13.5	1	18.2	5	164.8
MDA3KP12A	12	13.3–14.7	1	19.9	5	150.8
MDA3KP13A	13	14.4–15.9	1	21.5	5	139.5
MDA3KP14A	14	15.6–17.2	1	23.2	2	129.3
MDA3KP15A	15	16.7–18.5	1	24.4	2	123
MDA3KP16A	16	17.8–19.7	1	26.0	2	115.4
MDA3KP17A	17	18.9–20.9	1	27.6	2	108.7
MDA3KP18A	18	20.0–22.1	1	29.2	2	102.7
MDA3KP20A	20	22.2–24.5	1	32.4	2	92.6
MDA3KP22A	22	24.4–26.9	1	35.5	2	84.5
MDA3KP24A	24	26.7–29.5	1	38.9	2	77.1
MDA3KP26A	26	28.9–31.9	1	42.1	2	71.3
MDA3KP28A	28	31.1–34.4	1	45.4	2	66.1
MDA3KP30A	30	33.3–36.8	1	48.8	2	62
MDA3KP33A	33	36.7–40.6	1	53.3	2	56.3
MDA3KP36A	36	40.0–44.2	1	58.1	2	51.6
MDA3KP40A	40	44.4–49.1	1	64.5	2	46.5

NOTE 1: For bidirectional types, indicate a C suffix as shown on page 2 in "Part Nomenclature"  
 Transient Voltage Suppressors are normally selected with reverse standoff voltage VWM, which should be equal to or greater than peak operating voltage.

# Package Outline Drawings

## MSMB/MSMC/MSML

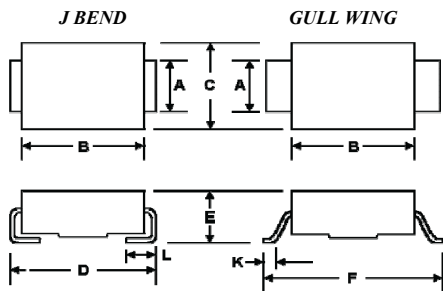

MSMB PACKAGE DIMENSIONS IN INCHES (DO-214AA/DO-215AA)								
	A	B	C	D	E	F	K	L
MIN	0.077	0.160	0.130	0.205	0.077	0.235	0.015	0.030
MAX	0.083	0.180	0.155	0.220	0.104	0.255	0.030	0.060
DIMENSIONS IN MILLIMETERS								
MIN	1.95	4.06	3.30	5.21	1.95	5.97	0.381	0.760
MAX	2.10	4.57	3.94	5.59	2.65	6.48	0.762	1.520
MSMC/MSML PACKAGE DIMENSIONS IN INCHES (DO-214AB/DO-215AB)								
	A	B	C	D	E	F	K	L
MIN	0.115	0.260	0.220	0.305	0.077	0.380	0.025	0.030
MAX	0.121	0.280	0.245	0.320	0.110	0.400	0.040	0.060
DIMENSIONS IN MILLIMETERS								
MIN	2.92	6.60	5.59	7.75	1.95	9.65	0.635	0.760
MAX	3.07	7.11	6.22	8.13	2.80	10.16	1.016	1.520

## MP4KE, MP6KE, M1.5KE & MLCE

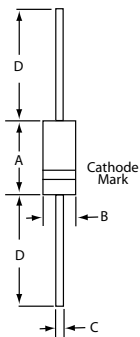

DIM	P4KE (DO-41)				P6KE (T-18)				1.5KE & LCE (Case 1)			
	INCHES		MM		INCHES		MM		INCHES		MM	
	MIN	MAX	MIN	MAX	MIN	MAX	MIN	MAX	MIN	MAX	MIN	MAX
A	-	0.205	-	5.207	0.330	0.350	8.39	8.89	0.360	0.375	9.144	9.525
B	-	0.107	-	2.72	0.130	0.145	3.31	3.68	0.190	0.205	4.826	5.207
C	0.03	0.034	0.76	0.86	0.038	0.042	0.97	1.06	0.038	0.042	0.965	1.067
D	1.00	-	25.4	-	1.00	-	25.4	-	1.10	-	27.9	-

## mini-PLAD

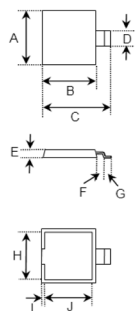

Ref.	Dimensions	
	mm	Inches
A	8.76	0.345
B	8.76	0.345
C	11.27	0.444
D	2.54	0.100
E	3.18	0.125
F	0.76	0.030
G	1.78	0.070
H	7.24	0.285
I	0.76	0.030
J	7.24	0.285

## M5KP, M15KP and MRT100KP Case 5A

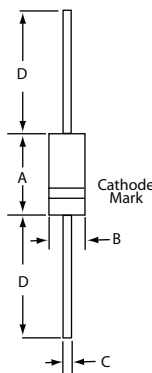

	RT100KP (Case 5A)			
	INCHES		MM	
	MIN	MAX	MIN	MAX
A	0.365	0.385	9.271	9.779
B	0.235	0.255	5.969	6.477
C	0.047	0.053	1.194	1.346
D	0.75	-	19.05	-

## PLAD

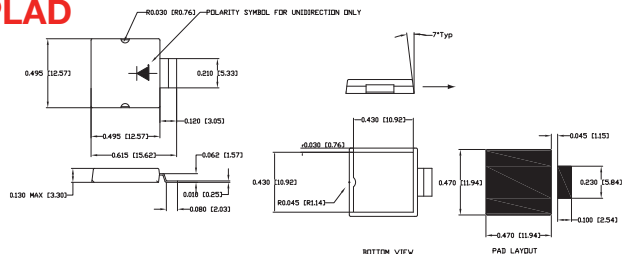

## Powermite1 DO-216AA

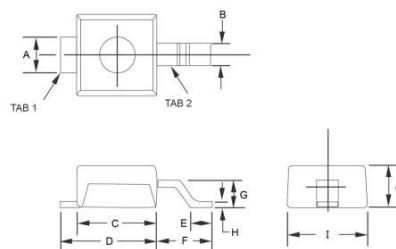

Ltr	Dimensions	
	Inch	Millimeters
A	0.100	2.54
B	0.105	2.67
C	0.050	1.27
D	0.030	0.76
E	0.025	0.64