



# MPQ2166A

## 6V, Dual 2A/2A or 3A/1A, Low I<sub>q</sub>, Synchronous Buck Regulator with PG and SS, AEC-Q100 Qualified

### DESCRIPTION

The MPQ2166A is an internally compensated, dual, PWM, synchronous, step-down regulator. It operates from a 2.7V to 6V input, and generates an output voltage as low as 0.6V. The MPQ2166A can be configured as a 2A/2A or 3A/1A output current regulator, and is ideal for powering portable equipment that runs on a single-cell Lithium-ion (Li+) battery due to its low 65 $\mu$ A quiescent current.

The device integrates dual, 55m $\Omega$ , high-side switches and 20m $\Omega$  synchronous rectifiers for high efficiency without an external Schottky diode. The MPQ2166A has peak current mode control and internal compensation, and is capable of low-dropout configurations. Both channels can operate at 100% duty cycle.

Full protection features include cycle-by-cycle current limiting and thermal shutdown.

The MPQ2166A requires a minimal number of readily available, standard external components, and is available in a QFN-18 (2.5mmx3.5mm) package.

### FEATURES

- 2.7V to 6V Operating Input Range
- 2A/2A or 3A/1A Continuous Current
- 55m $\Omega$ /20m $\Omega$  R<sub>DS(ON)</sub>
- Configurable Frequency Up to 3MHz
- External Sync Clock Up to 3MHz
- 180° Phase-Shift Operation
- Power Good (PG) Indicators
- External Soft Start (SS) and Track Mode
- Selectable Advanced Asynchronous Mode (AAM) or Forced Continuous Conduction Mode (FCCM)
- Peak Efficiency >90%
- Adjustable 0.6V to 5.5V Output
- 100% Duty Cycle Operation
- 65 $\mu$ A Quiescent Current
- Cycle-by-Cycle Over-Current Protection (OCP)
- Short-Circuit Protection (SCP) with Hiccup Mode and Valley Current Detection
- Thermal Shutdown
- Available in a QFN-18 (2.5mmx3.5mm) Package
- Available in Wetable Flank Package
- Available in AEC-Q100 Grade-1

### APPLICATIONS

- Automotive Infotainment
- Automotive Clusters
- Automotive Telematics
- Battery-Powered Devices
- Portable Instruments

All MPS parts are lead-free, halogen-free, and adhere to the RoHS directive. For MPS green status, please visit the MPS website under Quality Assurance. "MPS", the MPS logo, and "Simple, Easy Solutions" are trademarks of Monolithic Power Systems, Inc. or its subsidiaries.

## TYPICAL APPLICATION

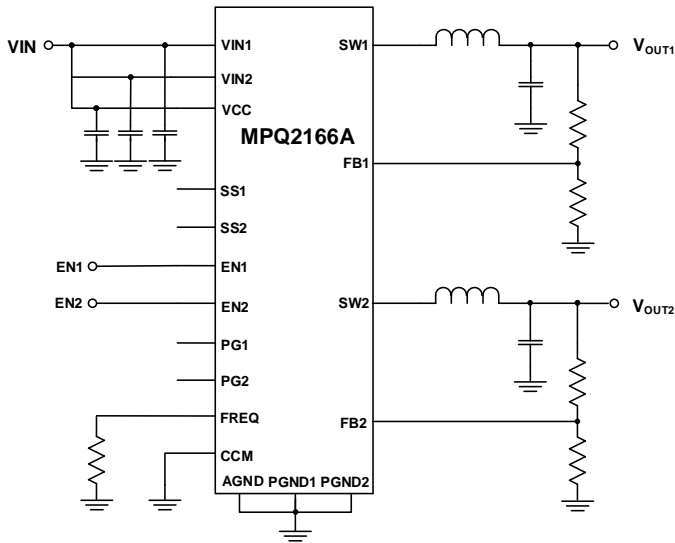

### Efficiency vs. Load Current

$V_{OUT1} = 1.8V$ ,  $L1 = 0.68\mu H$ ,  $f_{sw} = 2.25MHz$ ,  
AAM, one channel on

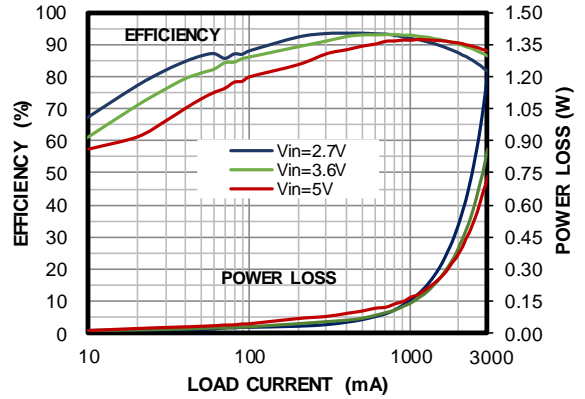

### ORDERING INFORMATION

Part Number*	Package	Top Marking	MSL Rating**
MPQ2166AGRHE-AEC1***	QFN-18 (2.5mmx3.5mm)	See Below	1

\* For Tape & Reel, add suffix -Z (e.g. MPQ2166AGRHE-AEC1-Z).

\*\* Moisture Sensitivity Level Rating

\*\*\* Wettable flank

### TOP MARKING

**BLZ**

**YWW**

**LLL**

BLZ: Product code of MPQ2166AGRHE-AEC1

Y: Year code

WW: Week code

LLL: Lot number

### PACKAGE REFERENCE

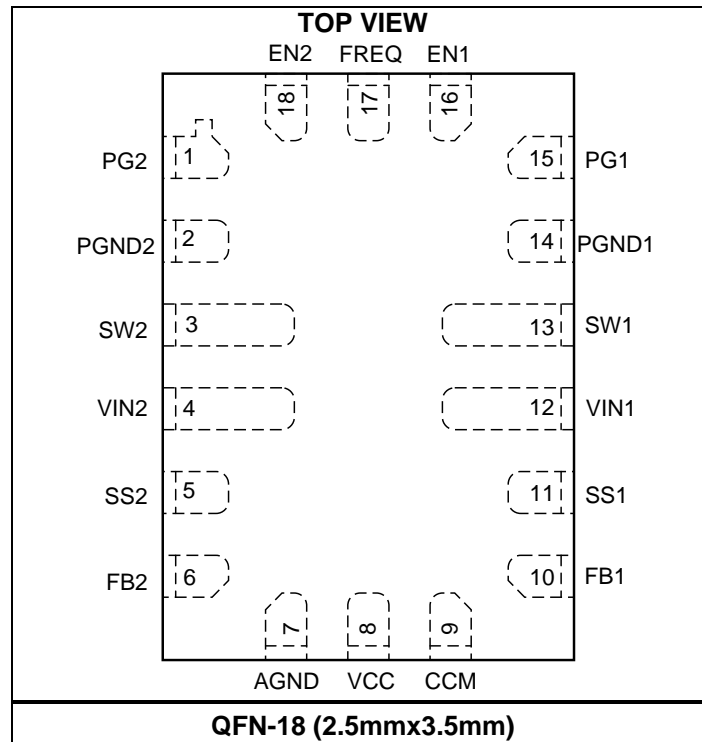

## PIN FUNCTIONS

Pin #	Name	Description
1	PG2	<b>Power good indicator for channel 2.</b> The output of PG2 is an open drain. Connect PG2 to the power source using a pull-up resistor. PG2 is pulled high when $V_{FB2}$ exceeds 90% of $V_{REF}$ ; PG is pulled low to GND if $V_{FB2}$ drops below 82% of $V_{REF}$ .
2	PGND2	<b>Power ground for channel 2.</b> Connect PGND2 to the negative terminals of the input and output capacitors with larger copper areas. PGND2 must be externally connected to PGND1 on the board.
3	SW2	<b>Switch node connection to the inductor for channel 2.</b> SW2 connects to the internal high- and low-side power MOSFET switches of the channel 2 buck.
4	VIN2	<b>Input supply for channel 2.</b> To reduce voltage spikes, place a decoupling capacitor to ground, close to VIN2.
5	SS2	<b>Soft start for channel 2.</b> Place a capacitor from SS2 to GND to set the soft-start time externally. Floating this pin will activate the internal default 0.5ms soft-start setting.
6	FB2	<b>Feedback for channel 2.</b> FB2 is the input to channel 2's error amplifier. An external resistive divider connects FB2 between the output and ground. The voltage on FB2 is compared to the internal 0.6V reference, and sets the regulation voltage on channel 2.
7	AGND	<b>Analog ground.</b> Externally connect AGND to PGND1 and PGND2 on the board.
8	VCC	<b>Power supply to the internal circuits.</b> Place a 0.1 $\mu$ F to 1 $\mu$ F decoupling capacitor between VCC and AGND. Connect VIN1, VIN2, and VCC together externally. It is not recommended to power these pins on separate power supplies.
9	CCM	<b>AAM or FCCM control.</b> Pull CCM high to enter forced continuous conduction mode (FCCM); pull CCM low to enter advanced asynchronous mode (AAM) at light-load. Do not float CCM.
10	FB1	<b>Feedback for channel 1.</b> FB1 is the input to the error amplifier of channel 1. An external resistive divider connects FB1 between the output and GND. The voltage on FB1 is compared to the internal 0.6V reference to set the regulation voltage on channel 1.
11	SS1	<b>Soft start for channel 1.</b> Place a capacitor from SS1 to GND to set the soft-start time externally. Floating this pin will activate the internal default 0.5ms soft-start setting.
12	VIN1	<b>Input supply for channel 1.</b> To reduce voltage spikes, place a decoupling capacitor to ground, close to VIN1.
13	SW1	<b>Switch node connection to the inductor for channel 1.</b> SW1 connects to the internal high- and low-side power MOSFET switches of the channel 1 buck.
14	PGND1	<b>Power ground for channel 1.</b> Connect PGND1 to the negative terminals of the input and output capacitors with larger copper areas. PGND1 must be externally connected to PGND2 on the board.
15	PG1	<b>Power good indicator for channel 1.</b> The output of PG1 is an open drain. Connect PG1 to the power source using a pull-up resistor. PG1 is pulled high when $V_{FB1}$ exceeds 90% of $V_{REF}$ ; PG1 is pulled low to GND if $V_{FB1}$ drops below 82% of $V_{REF}$ .
16	EN1	<b>Enable control for channel 1.</b> Pull EN1 below the specified threshold (0.4V) to shut down the chip. Pull EN above the specified threshold (1.6V) to enable the chip. Do not float EN1.
17	FREQ	<b>Frequency set.</b> Connect a resistor to GND to set the switching frequency. The switching frequency can be synchronized by an external clock via FREQ.
18	EN2	<b>Enable control for channel 2.</b> Pull EN2 below the specified threshold (0.4V) to shut down the chip. Pull EN above the specified threshold (1.6V) to enable the chip. Do not float EN2.

**ABSOLUTE MAXIMUM RATINGS** <sup>(1)</sup>

Supply voltage ( $V_{IN}$ ) .....	6.5V
$V_{SW}$ .....	-0.3V to $V_{IN} + 0.3V$
All other pins .....	-0.3V to +6.5V
Junction temperature .....	150°C
Lead temperature .....	260°C
Storage temperature .....	-65°C to +150°C
Continuous power dissipation ( $T_A = 25^\circ\text{C}$ ) <sup>(2) (5)</sup>	
QFN-18 (2.5mmx3.5mm) .....	3.6W

**ESD Rating**

Human body model (HBM) .....	$\pm 2\text{kV}$
Charged device model (CDM) .....	$\pm 750\text{V}$

**Recommended Operating Conditions**

Supply voltage ( $V_{IN}$ ) .....	2.7V to 6V
Output voltage ( $V_{OUT}$ ) .....	0.6V to 5.5V
Operating junction temp ( $T_J$ ) .....	
.....	-40°C to +125°C <sup>(3)</sup>

<b>Thermal Resistance</b>	$\theta_{JA}$	$\theta_{JC}$
QFN-18 (2.5mmx3.5mm)		
JESD51-7 <sup>(4)</sup> .....	50.....	12...°C/W
EV2166A-RH-00A <sup>(5)</sup> .....	34.8.....	2.7...°C/W

**Notes:**

- 1) Exceeding these ratings may damage the device.
- 2) The maximum allowable power dissipation is a function of the maximum junction temperature,  $T_J$  (MAX), the junction-to-ambient thermal resistance,  $\theta_{JA}$ , and the ambient temperature,  $T_A$ . The maximum allowable continuous power dissipation at any ambient temperature is calculated by  $P_D$  (MAX) =  $(T_J$  (MAX) -  $T_A$ ) /  $\theta_{JA}$ . Exceeding the maximum allowable power dissipation produces an excessive die temperature, causing the regulator to go into thermal shutdown. Internal thermal shutdown circuitry protects the device from permanent damage.
- 3) The device may be able to operate at junction temperatures exceeding 125°C. Contact MPS for details.
- 4) Measured on JESD51-7, 4-layer PCB.
- 5) Measured on MPS standard EVB, 6.35cmx6.35cm, 4-layer PCB.

## ELECTRICAL CHARACTERISTICS

$V_{IN} = 5V$ ,  $T_J = -40^{\circ}C$  to  $+125^{\circ}C$ , typical values are at  $T_J = 25^{\circ}C$ , unless otherwise noted.

Parameters	Symbol	Condition	Min	Typ	Max	Units
Quiescent supply current	$I_Q$	$V_{IN} = 5V$ , $V_{EN} = 2V$ , $V_{FB} = 0.65V$ , no switching		65	90	$\mu A$
Shutdown current	$I_{SHDN}$	$V_{EN} = 0V$ , CCM=GND, $T_J = 25^{\circ}C$		0	0.2	$\mu A$
		$V_{EN} = 0V$ , CCM = GND, $T_J = -40^{\circ}C$ to $+85^{\circ}C$ <sup>(6)</sup>		0	5	$\mu A$
		$V_{EN} = 0V$ , CCM = GND, $T_J = 85^{\circ}C$ to $125^{\circ}C$			8	$\mu A$
Input under-voltage lockout threshold	$V_{UVLO}$	$V_{IN1}$ , $V_{IN2}$ , VCC rising		2.4	2.55	V
Input under-voltage lockout hysteresis	$V_{UVLO\_HYS}$	$V_{IN1}$ , $V_{IN2}$ , VCC UVLO hysteresis		230		mV
Regulated FB voltage	$V_{FB}$	$T_J = 25^{\circ}C$	0.593	0.600	0.607	V
		$T_J = -40^{\circ}C$ to $+125^{\circ}C$	0.588	0.600	0.612	V
FB input current	$I_{FB}$	$V_{FB} = 0.65V$		0	50	nA
EN high threshold	$V_{EN\_H}$		1.6			V
EN low threshold	$V_{EN\_L}$				0.4	V
EN input current	$I_{EN}$	$V_{EN} = 2V$		0	0.1	$\mu A$
		$V_{EN} = 0V$		0	0.1	
HS switch on resistance	$R_{DSON\_P}$	$V_{IN} = 5V$		55	90	m $\Omega$
LS switch on resistance	$R_{DSON\_N}$	$V_{IN} = 5V$		20	45	m $\Omega$
SW leakage current	$I_{SW\_LK}$	$V_{EN} = 0V$ , $V_{IN} = 6V$ , $V_{SW} = 0V$ and $6V$ , $T_J = 25^{\circ}C$	-1	0	+1	$\mu A$
HS switch current limit <sup>(6)</sup>	$I_{HS\_LIMIT}$	Sourcing	3.4	4.8	6.2	A
LS valley current limit <sup>(6)</sup>	$I_{VALLEY}$			3.9		A
LS switch current limit	$I_{LS\_LIMIT}$	Sinking, CCM	1			A
Oscillator frequency accuracy	$f_{SW}$	$R_{FREQ} = 665k\Omega$	298	350	402	kHz
		$R_{FREQ} = 200k\Omega$	850	1000	1150	kHz
		$R_{FREQ} = 51k\Omega$	2700	3000	3300	kHz
Sync frequency range	$f_{SYNC}$		0.35		3	MHz
Phase shift				180		degrees
Minimum on time <sup>(6)</sup>	$t_{ON\_MIN}$			55		ns
Minimum off time <sup>(6)</sup>	$t_{OFF\_MIN}$			50		ns
Maximum duty cycle	$D_{MAX}$			100		%
Thermal shutdown threshold <sup>(6)</sup>	$T_D$			175		$^{\circ}C$
Thermal shutdown hysteresis <sup>(6)</sup>	$T_{D\_HYS}$			40		$^{\circ}C$
Soft-start charging current	$I_{SS}$	$V_{SS} = 0V$	2	3.2	5	$\mu A$
Power good rising threshold	$PGOOD_{Vth-Hi}$		0.85	0.9	0.95	$V_{FB}$
Power good falling threshold	$PGOOD_{Vth-Lo}$		0.77	0.82	0.87	$V_{FB}$
Power good rising delay	$t_{PGOOD\_R}$			30		$\mu s$
Power good falling delay	$t_{PGOOD\_F}$			40		$\mu s$
CCM on threshold			1.6			V
CCM off threshold					0.4	V

**Note:**

6) Guaranteed by design and characterization. Not tested in production.

## TYPICAL CHARACTERISTICS

$V_{IN} = 5V$ ,  $T_J = -40^{\circ}C$  to  $+125^{\circ}C$ , unless otherwise noted.

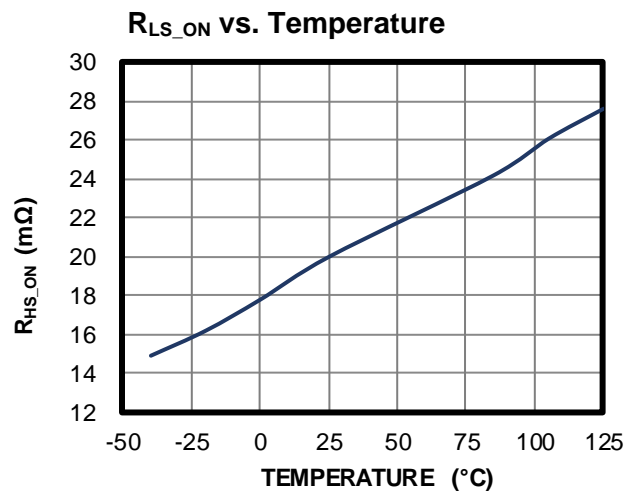
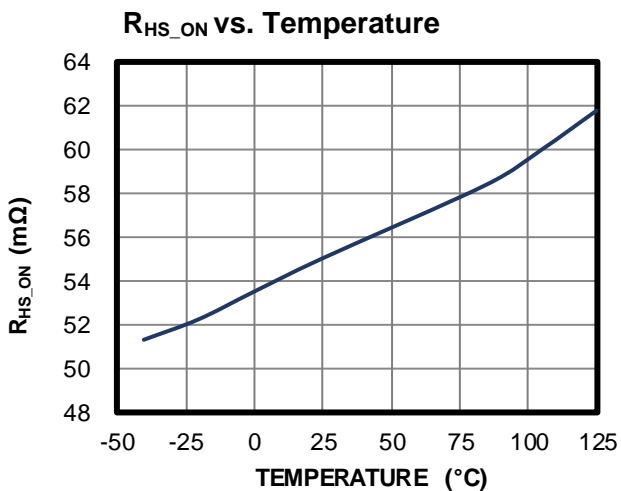
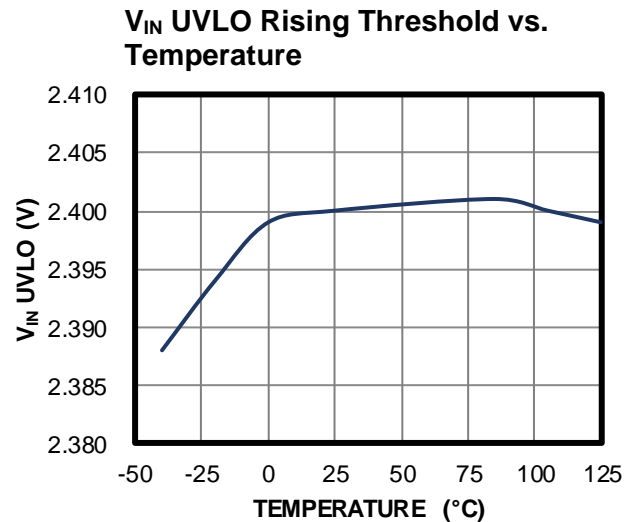
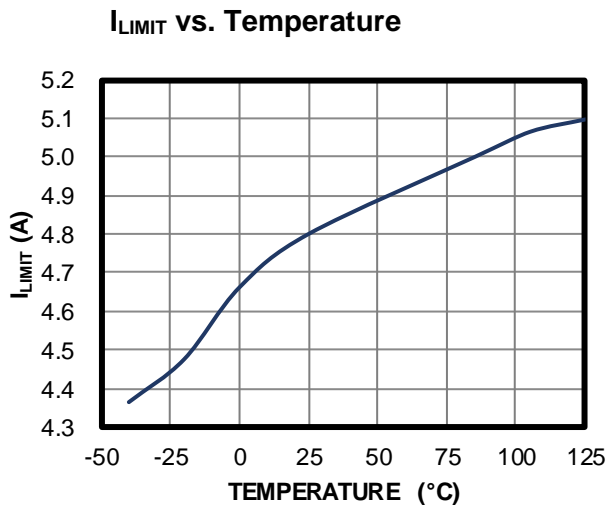
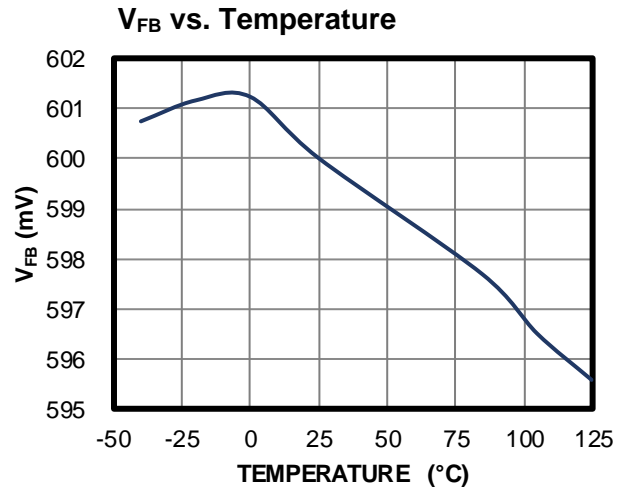
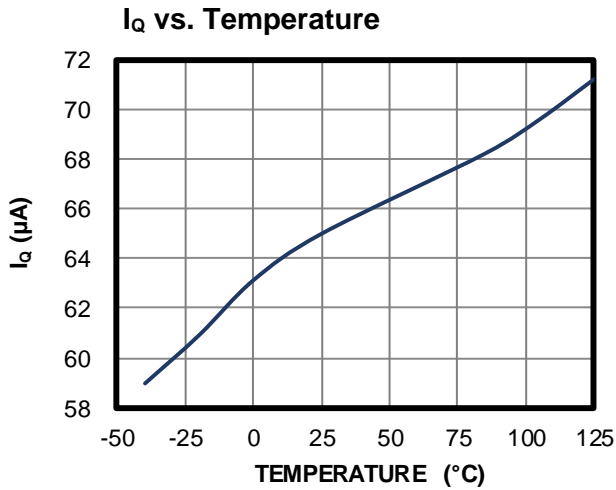

**TYPICAL CHARACTERISTICS (continued)**

$V_{IN} = 5V$ ,  $T_J = -40^{\circ}C$  to  $+125^{\circ}C$ , unless otherwise noted.

**PG Rising/Falling Threshold vs. Temperature**

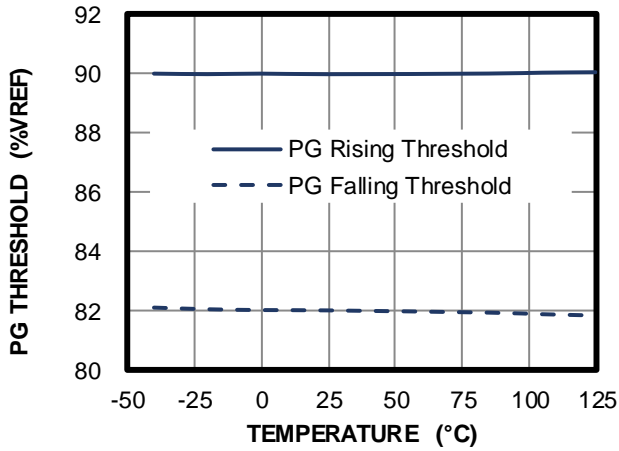

**Frequency vs. Temperature**

$f_{sw} = 350kHz$

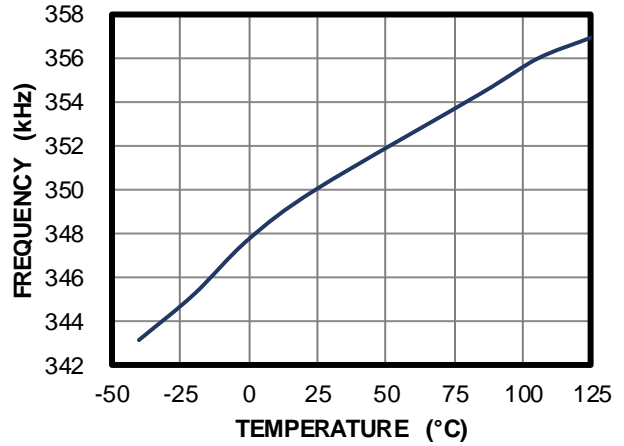

**Frequency vs. Temperature**

$f_{sw} = 1MHz$

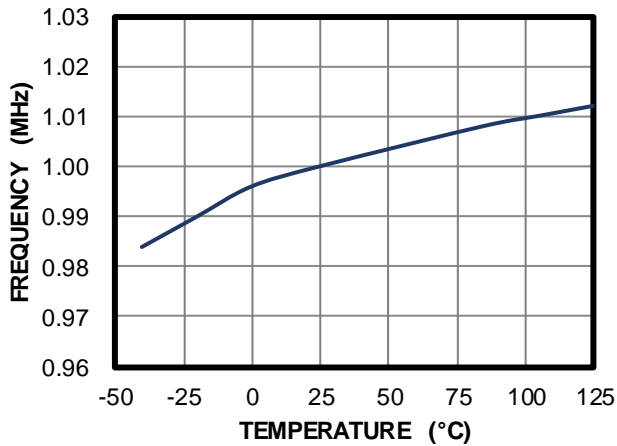

**Frequency vs. Temperature**

$f_{sw} = 3MHz$

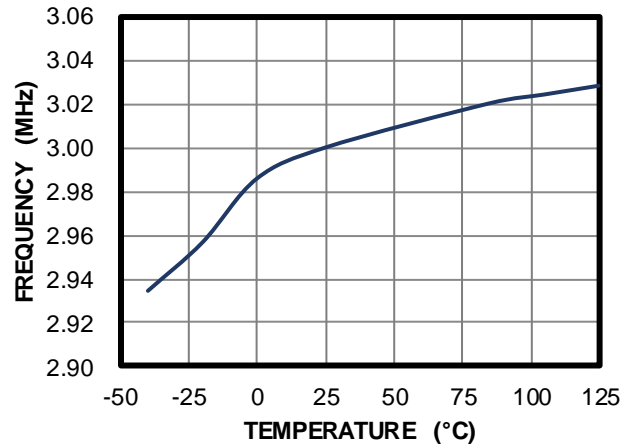



## TYPICAL PERFORMANCE CHARACTERISTICS

$V_{IN} = 5V$ ,  $V_{OUT1} = 1.8V$ ,  $V_{OUT2} = 1.2V$ ,  $L1 = L2 = 1.5\mu H$ ,  $f_{SW} = 2.25MHz$ ,  $T_A = 25^\circ C$ , unless otherwise noted.

### Efficiency vs. Load Current

$V_{OUT1} = 1.8V$ ,  $L1 = 0.68\mu H$ , AAM, one channel on

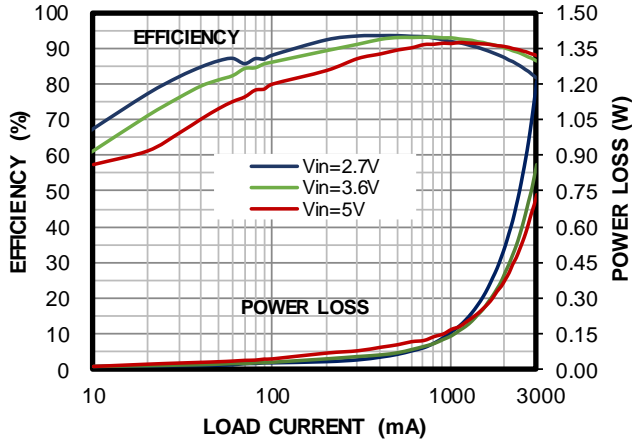

### Efficiency vs. Load Current

$V_{OUT2} = 1.2V$ , AAM, one channel on

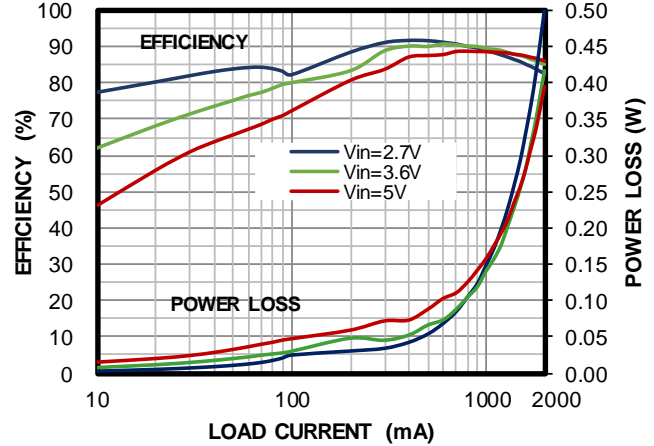

### Efficiency vs. Load Current

$V_{OUT1} = 1.8V$ ,  $L1 = 0.68\mu H$ , FCCM, one channel on

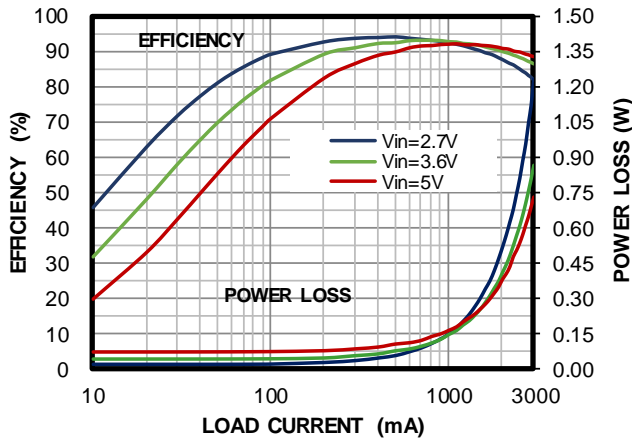

### Efficiency vs. Load Current

$V_{OUT2} = 1.2V$ , FCCM, one channel on

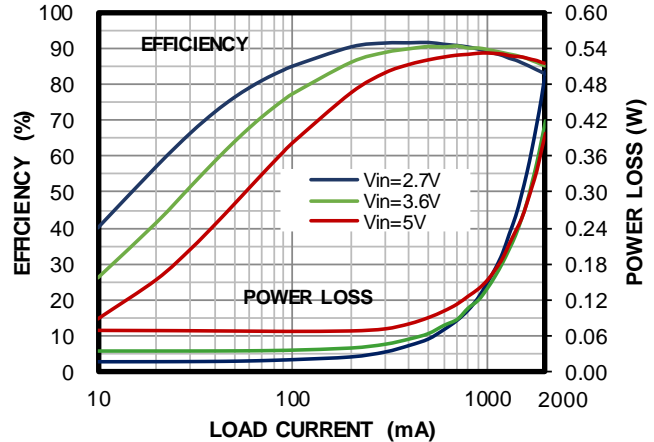

### Load Regulation

$V_{OUT1} = 1.8V$ ,  $L1 = 0.68\mu H$ , AAM, one channel on

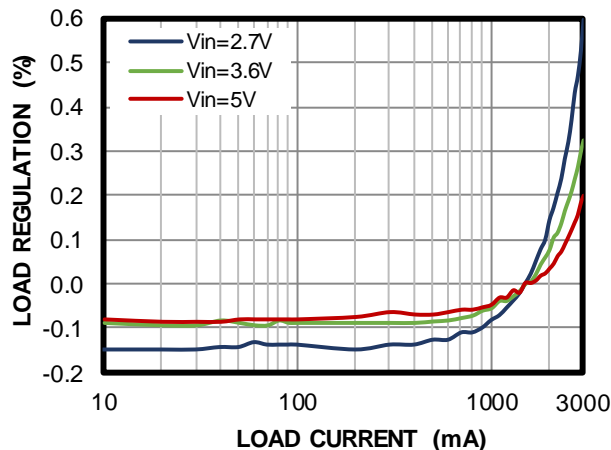

### Load Regulation

$V_{OUT2} = 1.2V$ , AAM, one channel on

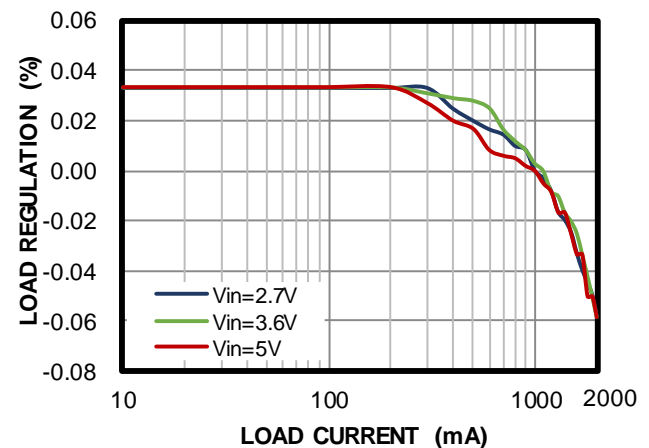

**TYPICAL PERFORMANCE CHARACTERISTICS (continued)**

$V_{IN} = 5V$ ,  $V_{OUT1} = 1.8V$ ,  $V_{OUT2} = 1.2V$ ,  $L1 = L2 = 1.5\mu H$ ,  $f_{SW} = 2.25MHz$ ,  $T_A = 25^\circ C$ , unless otherwise noted.

**Load Regulation**

$V_{OUT1} = 1.8V$ ,  $L1 = 0.68\mu H$ , FCCM, one channel on

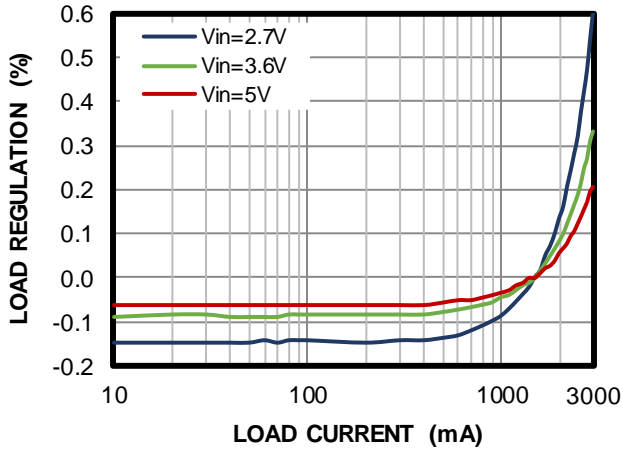
**Load Regulation**

$V_{OUT2} = 1.2V$ , FCCM, one channel on

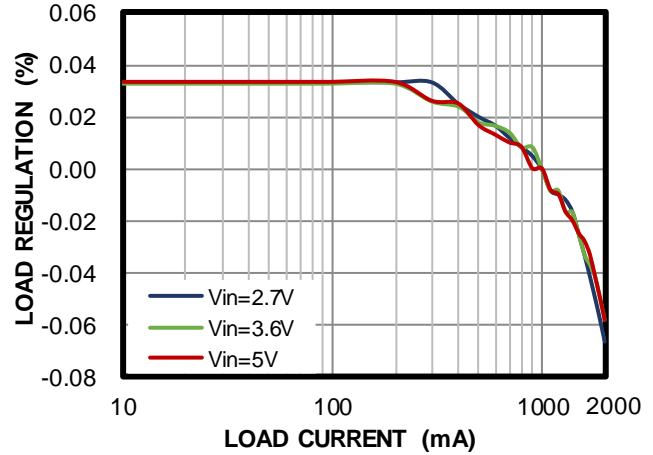
**Line Regulation**

$V_{OUT1} = 1.8V$ ,  $L = 0.68\mu H$ , AAM, one channel on

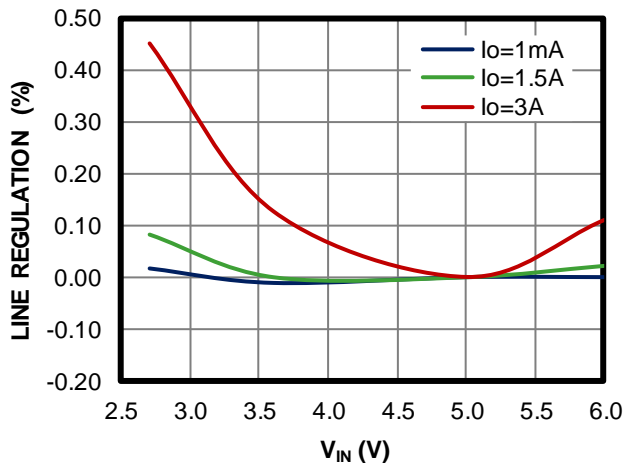
**Line Regulation**

$V_{OUT2} = 1.2V$ , AAM, one channel on

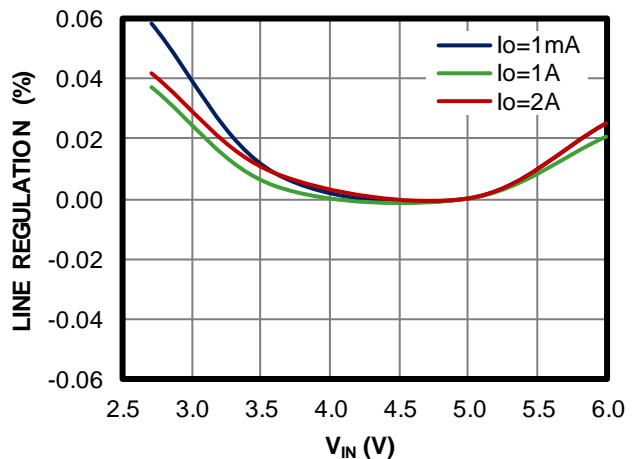
**Line Regulation**

$V_{OUT1} = 1.8V$ ,  $L = 0.68\mu H$ , FCCM, one channel on

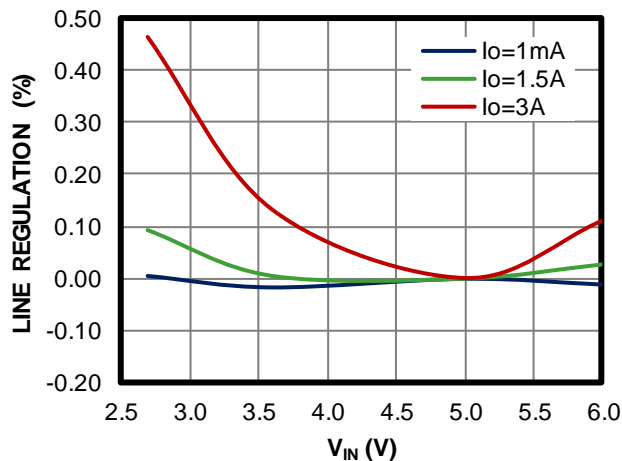
**Line Regulation**

$V_{OUT2} = 1.2V$ , FCCM, one channel on

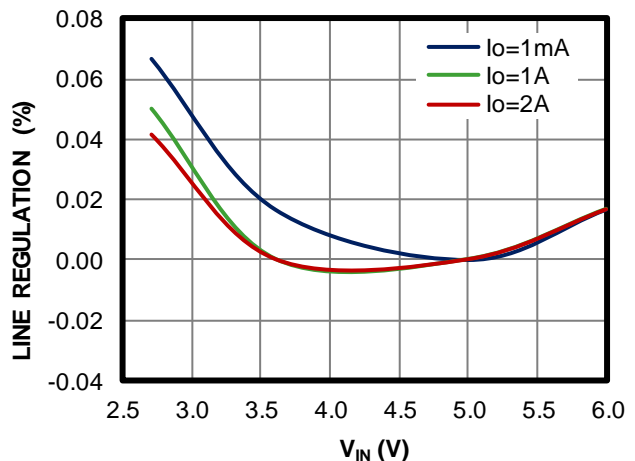

**TYPICAL PERFORMANCE CHARACTERISTICS (continued)**

$V_{IN} = 5V$ ,  $V_{OUT1} = 1.8V$ ,  $V_{OUT2} = 1.2V$ ,  $L1 = L2 = 1.5\mu H$ ,  $f_{SW} = 2.25MHz$ ,  $T_A = 25^\circ C$ , unless otherwise noted.

**Case Thermal Rise**

$V_{IN} = 5V$ ,  $I_{OUT1} = I_{OUT2} = 0A$  to  $2A$ , AAM, both channels on

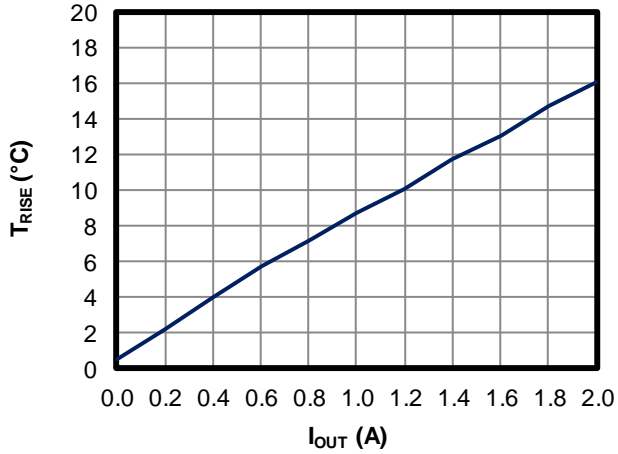

**Case Thermal Rise**

$V_{IN} = 5V$ ,  $I_{OUT1} = 0A$  to  $3A$ ,  $I_{OUT2} = 1A$ , AAM,  $L1 = 0.68\mu H$ , both channels on

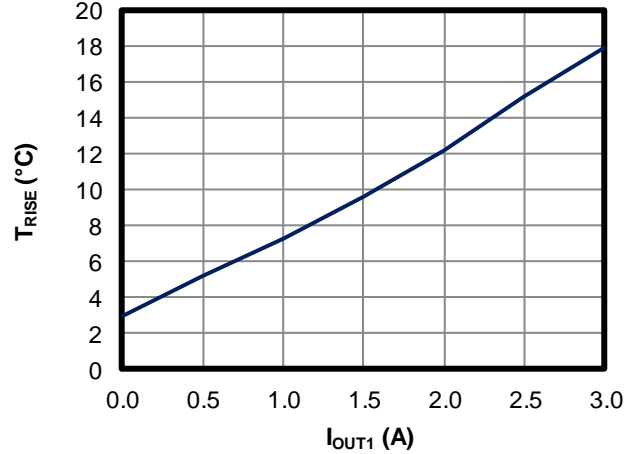

**TYPICAL PERFORMANCE CHARACTERISTICS (continued)**

$V_{IN} = 5V$ ,  $V_{OUT1} = 1.8V$ ,  $V_{OUT2} = 1.2V$ ,  $L1 = L2 = 1.5\mu H$ ,  $f_{SW} = 2.25MHz$ ,  $T_A = 25^\circ C$ , unless otherwise noted.

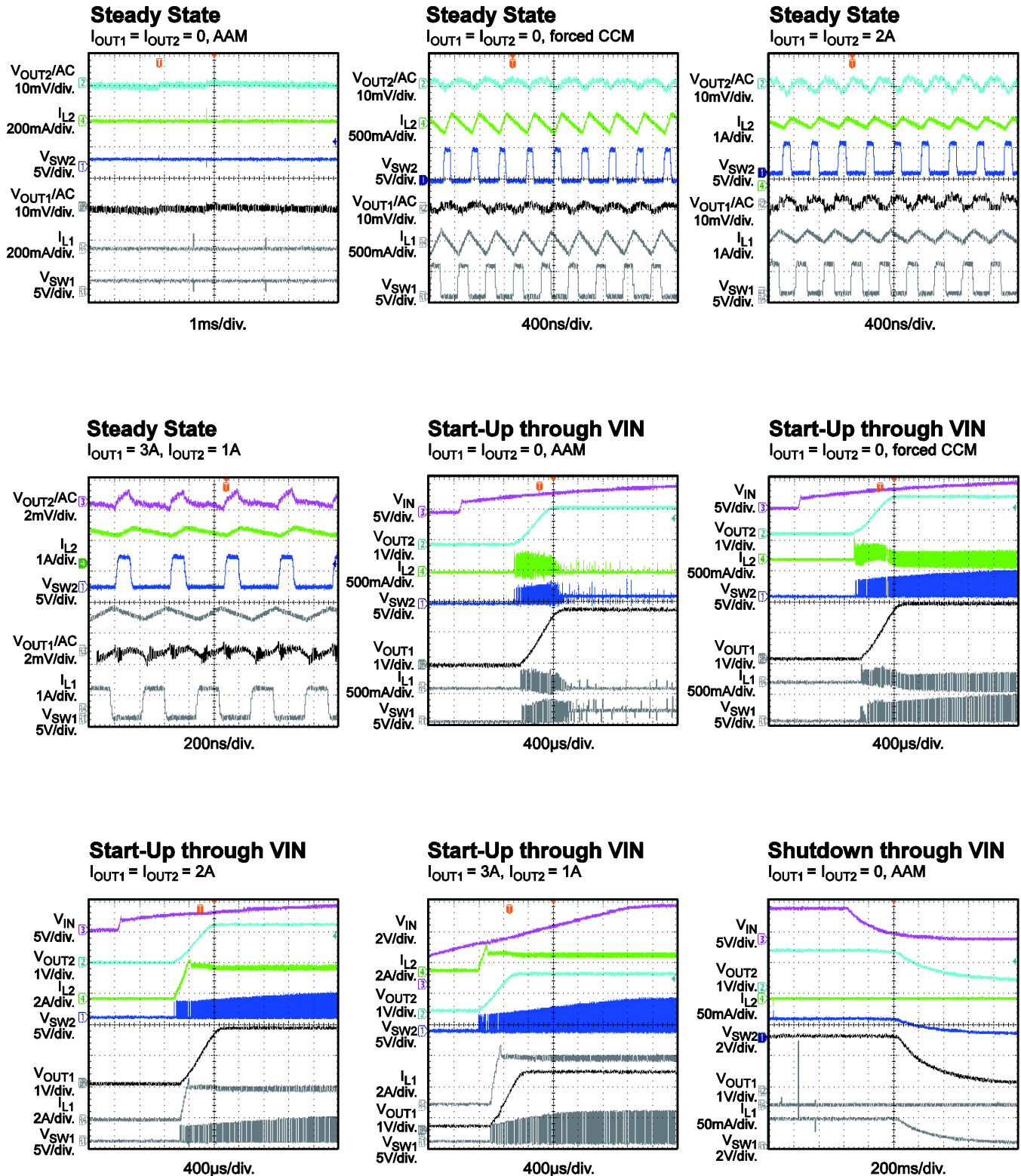

**TYPICAL PERFORMANCE CHARACTERISTICS (continued)**

$V_{IN} = 5V$ ,  $V_{OUT1} = 1.8V$ ,  $V_{OUT2} = 1.2V$ ,  $L1 = L2 = 1.5\mu H$ ,  $f_{SW} = 2.25MHz$ ,  $T_A = 25^\circ C$ , unless otherwise noted.

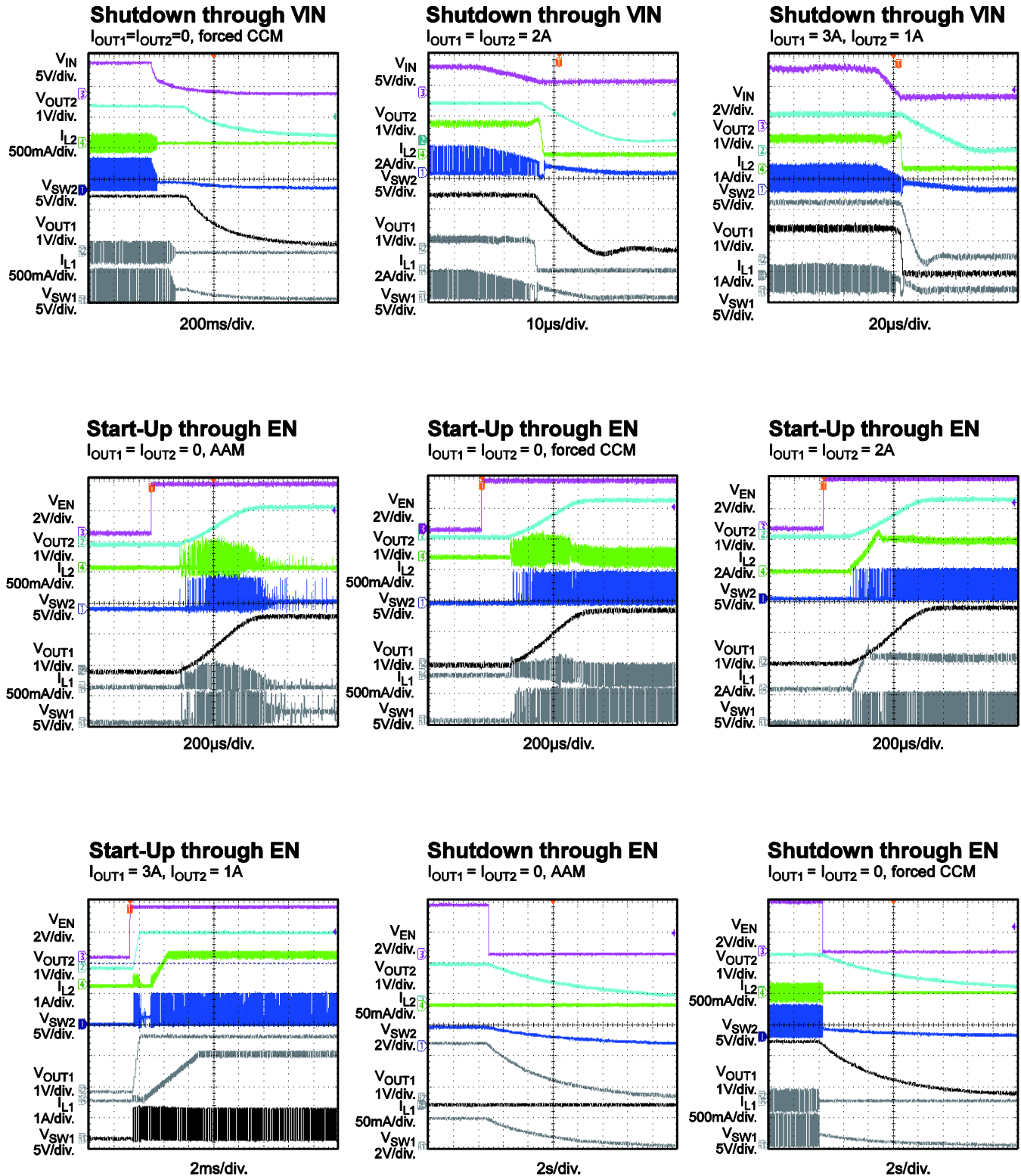

**TYPICAL PERFORMANCE CHARACTERISTICS (continued)**

$V_{IN} = 5V$ ,  $V_{OUT1} = 1.8V$ ,  $V_{OUT2} = 1.2V$ ,  $L1 = L2 = 1.5\mu H$ ,  $f_{SW} = 2.25MHz$ ,  $T_A = 25^\circ C$ , unless otherwise noted.

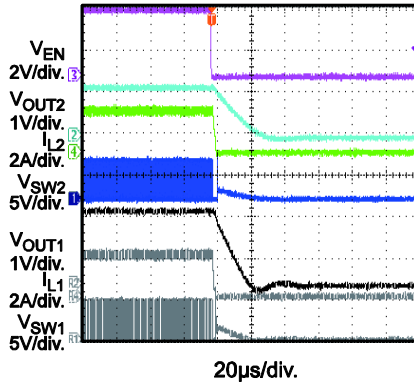
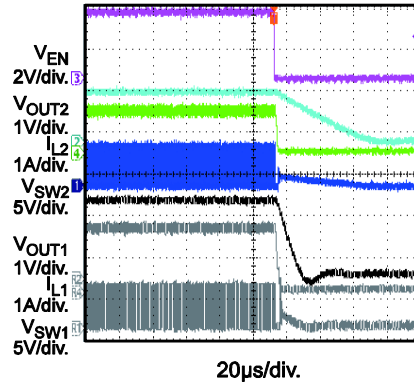
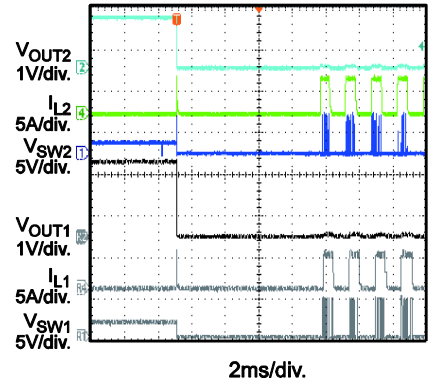
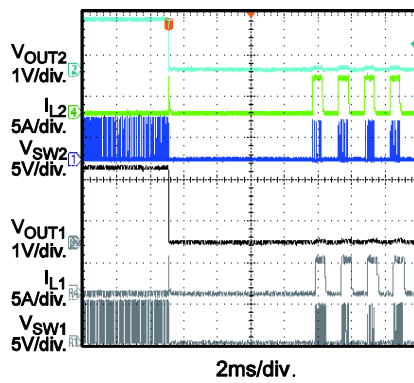
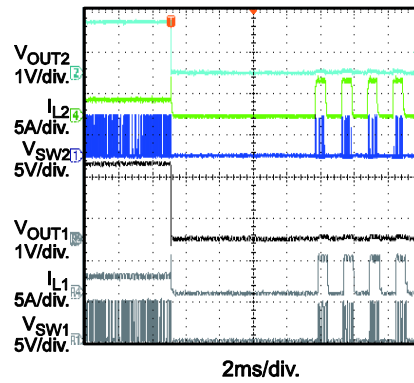
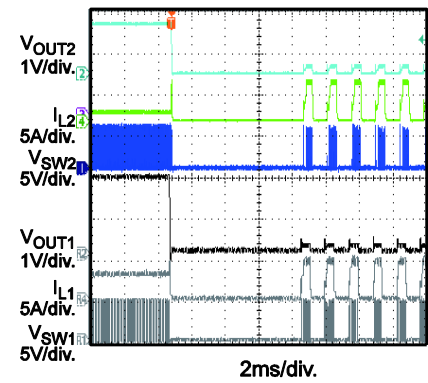
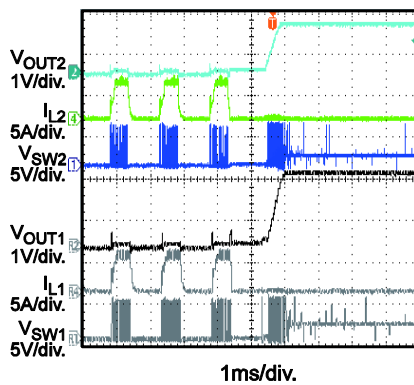
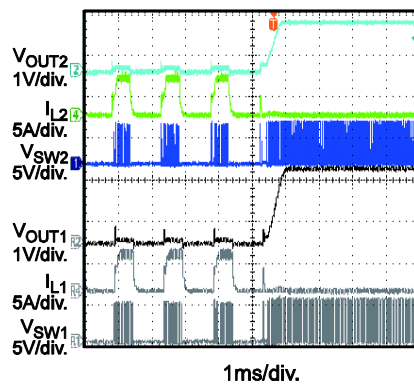
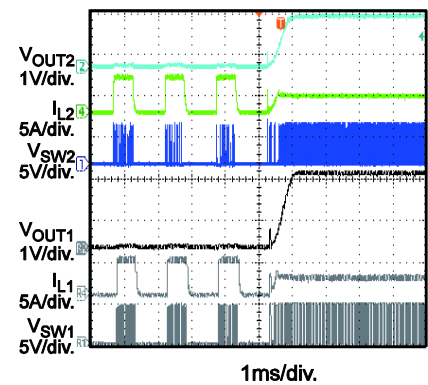
**Shutdown through EN**
 $I_{OUT1} = I_{OUT2} = 2A$ 

**Shutdown through EN**
 $I_{OUT1} = 3A$ ,  $I_{OUT2} = 1A$ 

**SCP Entry**
 $I_{OUT1} = I_{OUT2} = 0$ , AAM

**SCP Entry**
 $I_{OUT1} = I_{OUT2} = 0$ , forced CCM

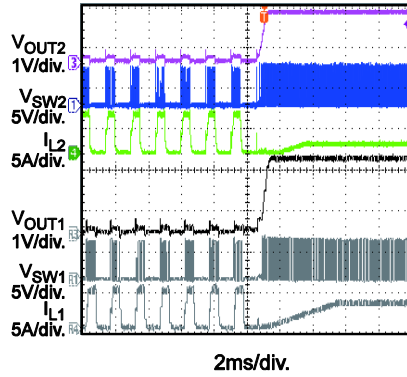
**SCP Entry**
 $I_{OUT1} = I_{OUT2} = 2A$ 

**SCP Entry**
 $I_{OUT1} = 3A$ ,  $I_{OUT2} = 1A$ 

**SCP Recovery**
 $I_{OUT1} = I_{OUT2} = 0$ , AAM

**SCP Recovery**
 $I_{OUT1} = I_{OUT2} = 0$ , forced CCM

**SCP Recovery**
 $I_{OUT1} = I_{OUT2} = 2A$ 

**TYPICAL PERFORMANCE CHARACTERISTICS (continued)**

$V_{IN} = 5V$ ,  $V_{OUT1} = 1.8V$ ,  $V_{OUT2} = 1.2V$ ,  $L1 = L2 = 1.5\mu H$ ,  $f_{SW} = 2.25MHz$ ,  $T_A = 25^\circ C$ , unless otherwise noted.

**SCP Recovery**  
 $I_{OUT1} = 3A$ ,  $I_{OUT2} = 1A$



**SCP Steady State**

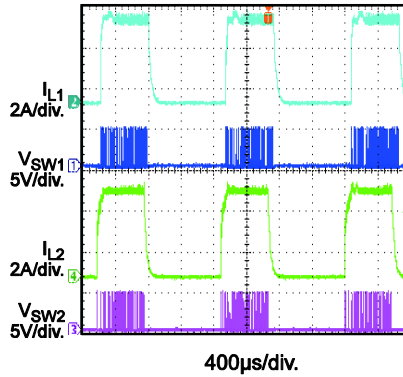

**Load Transient**

$I_{OUT1} = I_{OUT2} = 0$  to 2A, AAM,  
 1.6A/µs Speed

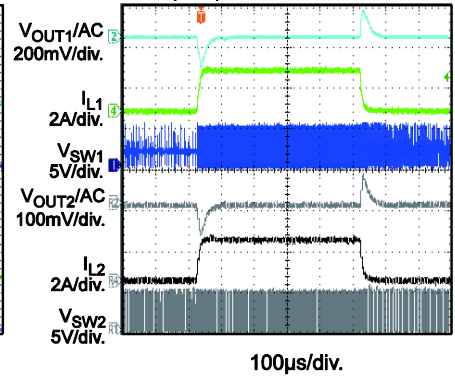

**Load Transient**

$I_{OUT1} = I_{OUT2} = 1$  to 2A, AAM,  
 1.6A/µs Speed

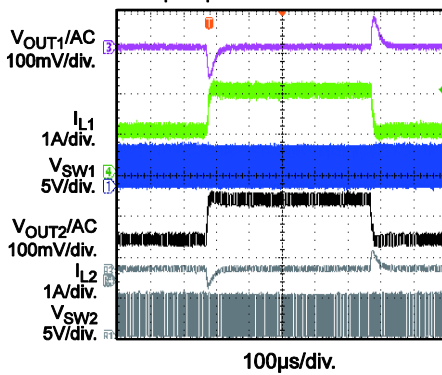

**Load Transient**

$I_{OUT1} = 0$  to 3A,  $I_{OUT2} = 0$  to 1A,  
 1.6A/µs Speed

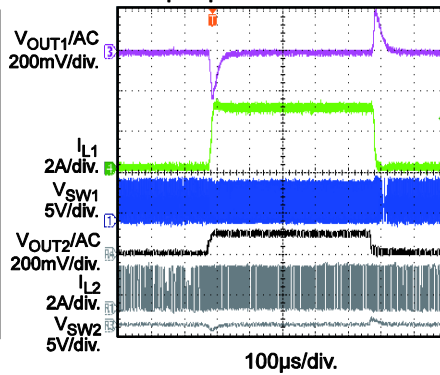

**Load Transient**

$I_{OUT1} = 1.5$  to 3A,  $I_{OUT2} = 0.5$  to 1A,  
 1.6A/µs Speed

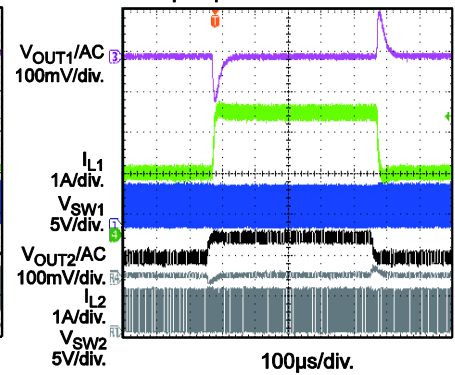

**TYPICAL PERFORMANCE CHARACTERISTICS (continued)**

$V_{IN} = 5V$ ,  $V_{OUT1} = 1.8V$ ,  $V_{OUT2} = 1.2V$ ,  $L1 = L2 = 1.5\mu H$ ,  $f_{SW} = 2.25MHz$ ,  $T_A = 25^\circ C$ , unless otherwise noted.

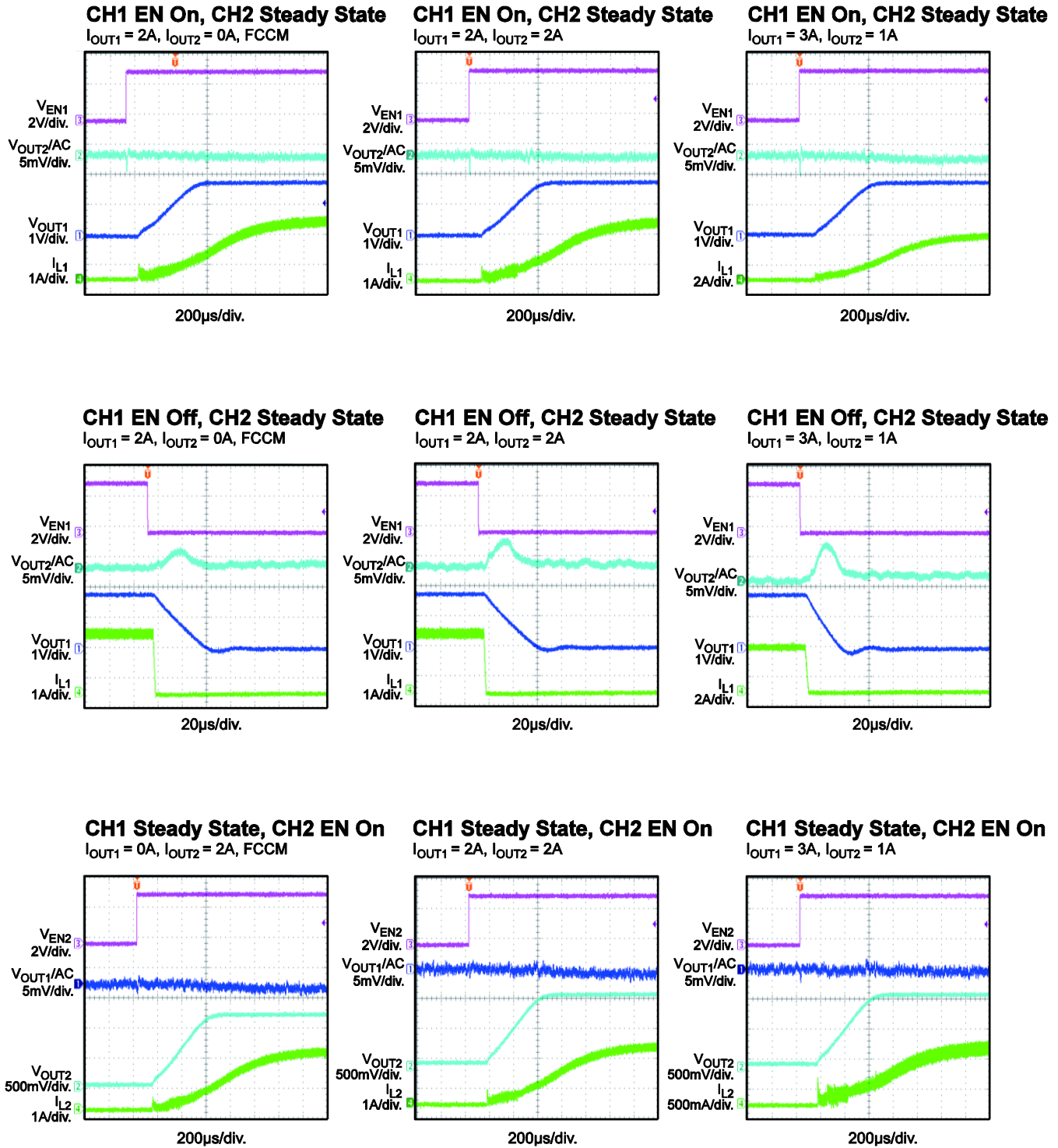



**TYPICAL PERFORMANCE CHARACTERISTICS (continued)**

$V_{IN} = 5V$ ,  $V_{OUT1} = 1.8V$ ,  $V_{OUT2} = 1.2V$ ,  $L1 = L2 = 1.5\mu H$ ,  $f_{SW} = 2.25MHz$ ,  $T_A = 25^\circ C$ , unless otherwise noted.

**CH1 Steady State, CH2 EN Off**  
 $I_{OUT1} = 0A$ ,  $I_{OUT2} = 2A$ , FCCM

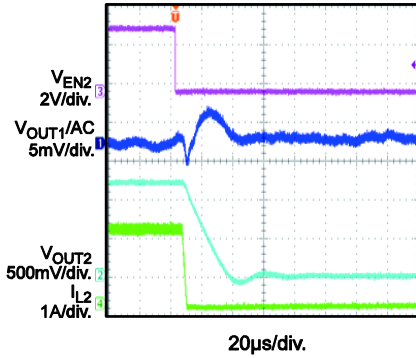

**CH1 Steady State, CH2 EN Off**  
 $I_{OUT1} = 2A$ ,  $I_{OUT2} = 2A$

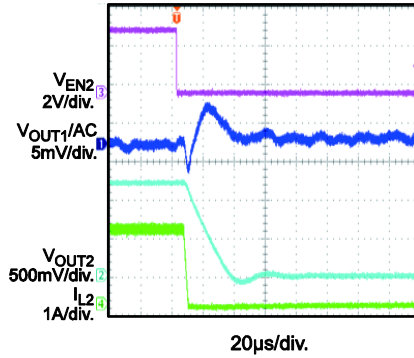

**CH1 Steady State, CH2 EN Off**  
 $I_{OUT1} = 3A$ ,  $I_{OUT2} = 1A$

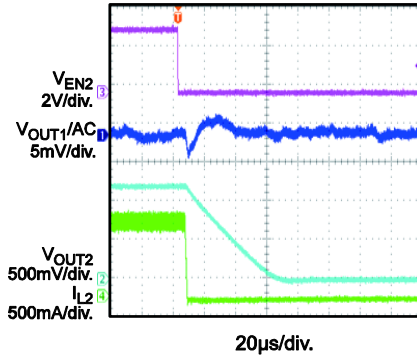

**CH1 Load Transient, CH2 Steady State**  
 $I_{OUT1} = 0A$  to  $2A$ ,  $1.6A/\mu s$  Speed,  
 $I_{OUT2} = 0A$ , FCCM

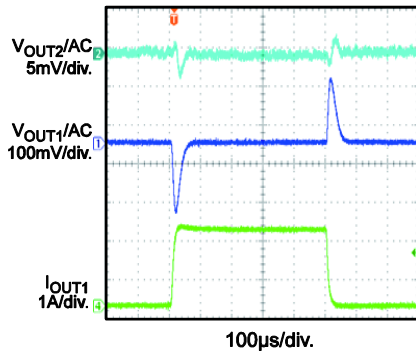

**CH1 Load Transient, CH2 Steady State**  
 $I_{OUT1} = 0A$  to  $2A$ ,  $1.6A/\mu s$  Speed,  
 $I_{OUT2} = 2A$

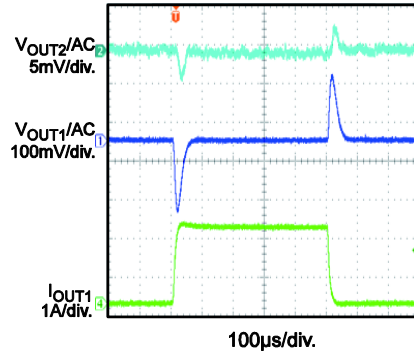

**CH1 Load Transient, CH2 Steady State**  
 $I_{OUT1} = 0A$  to  $3A$ ,  $1.6A/\mu s$  Speed,  
 $I_{OUT2} = 1A$

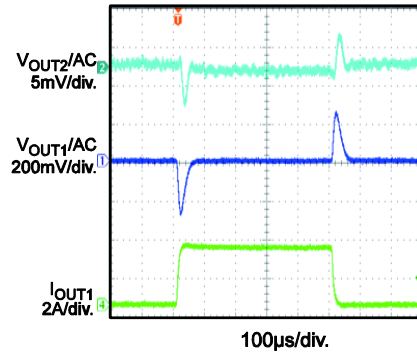

**CH1 Steady State, CH2 Load Transient**  
 $I_{OUT1} = 0A$ , FCCM,  $I_{OUT2} = 0A$  to  $2A$ ,  
 $1.6A/\mu s$  Speed

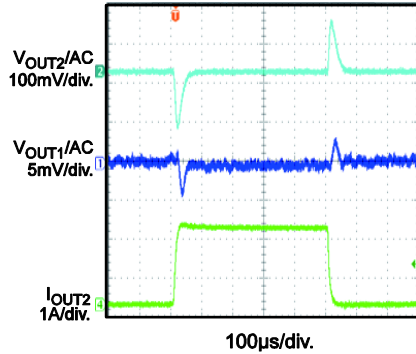

**CH1 Steady State, CH2 Load Transient**  
 $I_{OUT1} = 2A$ ,  $I_{OUT2} = 0A$  to  $2A$ ,  
 $1.6A/\mu s$  Speed

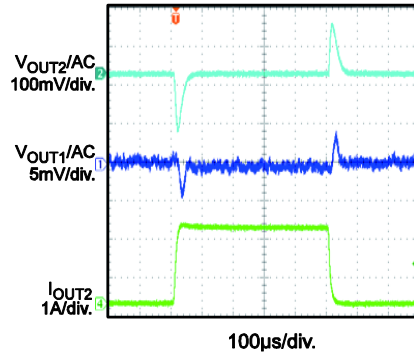

**CH1 Steady State, CH2 Load Transient**  
 $I_{OUT1} = 3A$ ,  $I_{OUT2} = 0A$  to  $1A$ ,  
 $1.6A/\mu s$  Speed

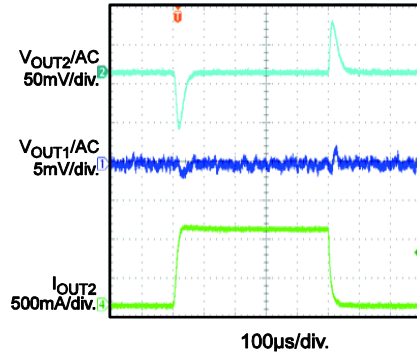

**TYPICAL PERFORMANCE CHARACTERISTICS (continued)**

$V_{IN} = 5V$ ,  $V_{OUT1} = 1.8V$ ,  $V_{OUT2} = 1.2V$ ,  $L1 = L2 = 1.5\mu H$ ,  $f_{SW} = 2.25MHz$ ,  $T_A = 25^\circ C$ , unless otherwise noted.

**CH1 Steady State, CH2 SCP Entry**  
 $I_{OUT1} = I_{OUT2} = 0A$ , FCCM

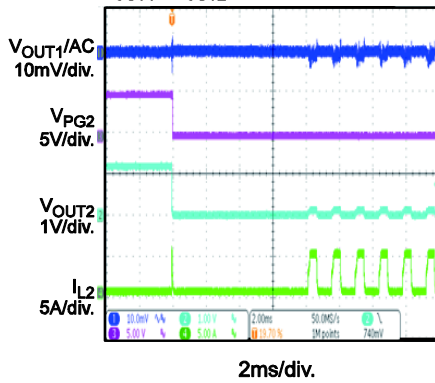

**CH1 Steady State, CH2 SCP Entry**  
 $I_{OUT1} = I_{OUT2} = 2A$

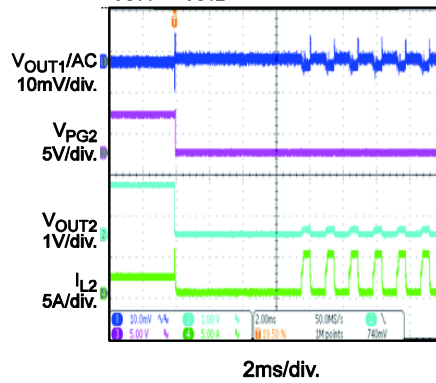

**CH1 Steady State, CH2 SCP Entry**  
 $I_{OUT1} = 3A$ ,  $I_{OUT2} = 1A$

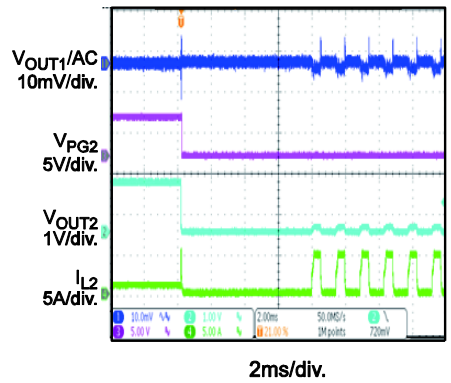

**CH1 Steady State, CH2 SCP Recovery**  
 $I_{OUT1} = I_{OUT2} = 0A$ , FCCM

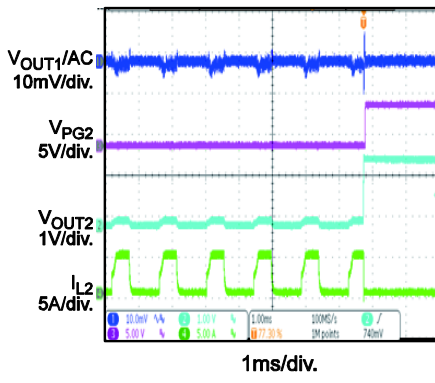

**CH1 Steady State, CH2 SCP Recovery**  
 $I_{OUT1} = I_{OUT2} = 2A$

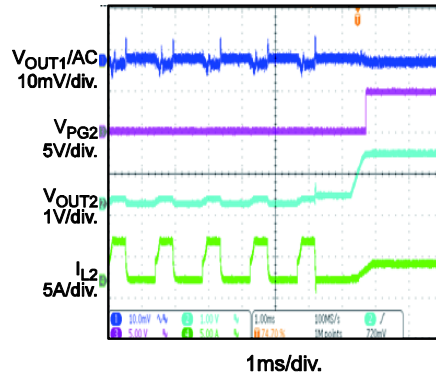

**CH1 Steady State, CH2 SCP Recovery**  
 $I_{OUT1} = 3A$ ,  $I_{OUT2} = 1A$

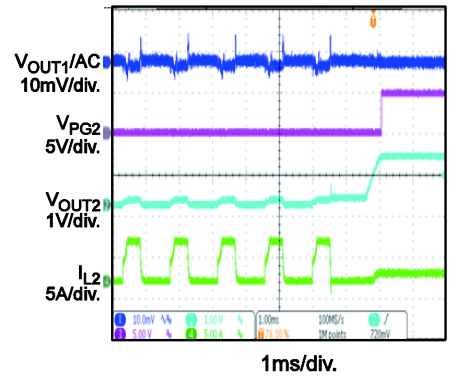

**CH1 SCP Entry, CH2 Steady State**  
 $I_{OUT1} = I_{OUT2} = 0A$ , FCCM

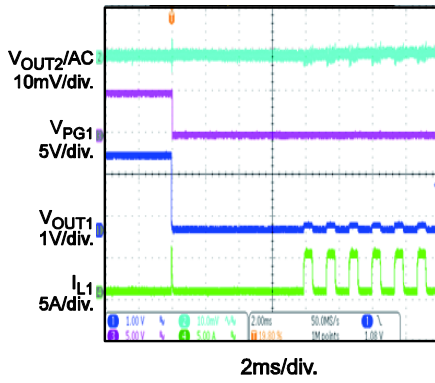

**CH1 SCP Entry, CH2 Steady State**  
 $I_{OUT1} = I_{OUT2} = 2A$

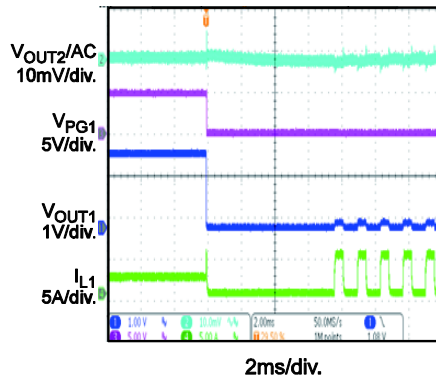

**CH1 SCP Entry, CH2 Steady State**  
 $I_{OUT1} = 3A$ ,  $I_{OUT2} = 1A$

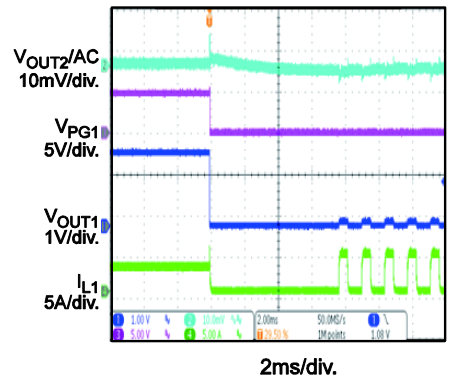

**TYPICAL PERFORMANCE CHARACTERISTICS (continued)**

$V_{IN} = 5V$ ,  $V_{OUT1} = 1.8V$ ,  $V_{OUT2} = 1.2V$ ,  $L1 = L2 = 1.5\mu H$ ,  $f_{SW} = 2.25MHz$ ,  $T_A = 25^\circ C$ , unless otherwise noted.

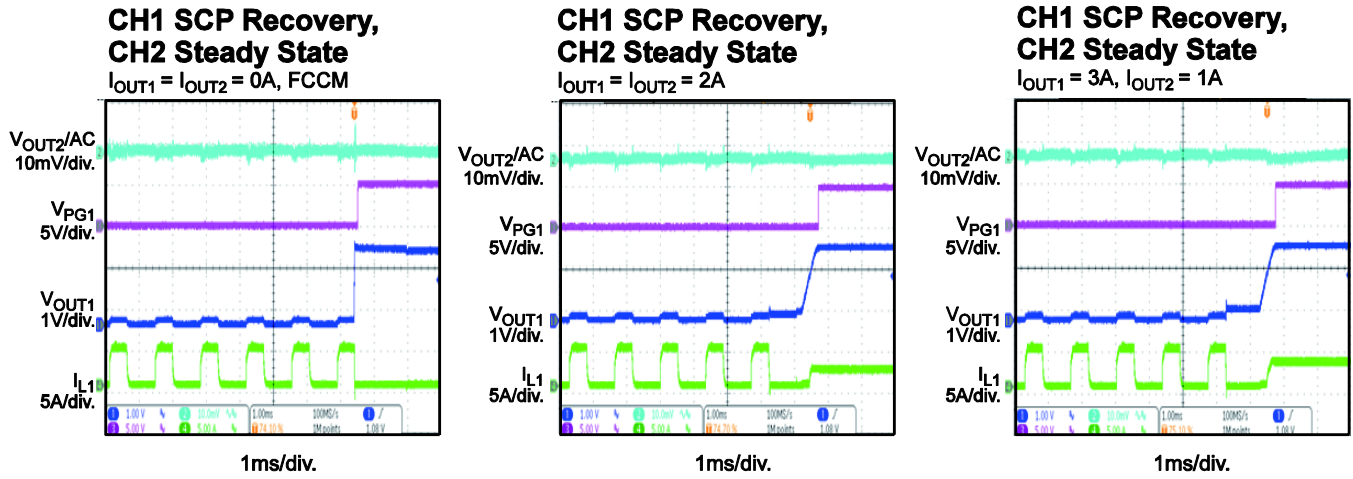

## FUNCTIONAL BLOCK DIAGRAM

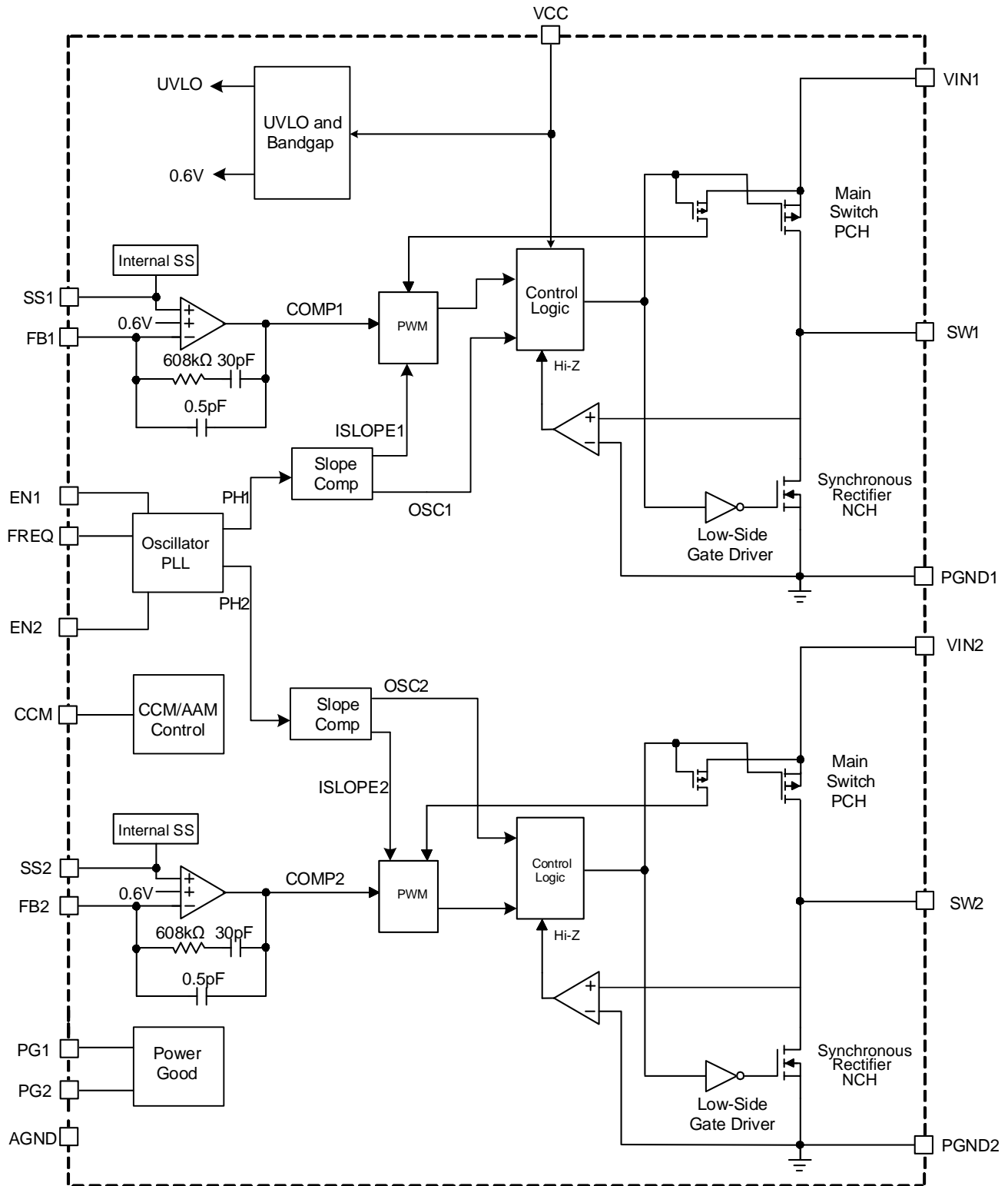

Figure 1: Functional Block Diagram

## OPERATION

The MPQ2166A is a fully integrated, dual-channel, synchronous step-down regulator. Both channels use peak current mode control with internal compensation for fast transient response and cycle-by-cycle current limiting.

The MPQ2166A is optimized for low-voltage, portable applications where efficiency and small size are critical.

### 180° Out-of-Phase Operation

The MPQ2166A operates the two channels in 180° out-of-phase operation to reduce input current ripple. This allows a smaller input bypass capacitor to be used. If both channels operate in FCCM, two internal clocks are used (see Figure 2). The high-side MOSFET turns on at the clock rising edge of the corresponding channel.

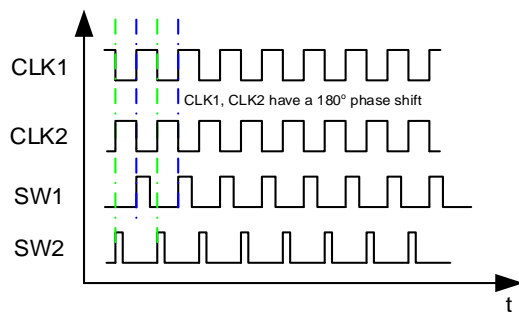

**Figure 2: 180° Out-of-Phase Operation**

If the switching frequency is stretched out for each channel during low-dropout mode, the MPQ2166A runs with a fixed off time with its own independent switching frequency. After the input voltage rises high again, frequency stretch mode ends. Then PWM mode resumes and synchronizes with the master oscillator for out-of-phase operation.

### Light-Load Operation

Under light-load conditions, the MPQ2166A can work in two different operating modes by setting the CCM pin to different statuses.

The MPQ2166A works in forced continuous conduction mode (FCCM) when the CCM pin is pulled above 1.6V. In this mode, the MPQ2166A works with a fixed frequency from no load to full load. The advantages of FCCM are its controllable frequency and lower output ripple at light load.

The MPQ2166A enters AAM when the CCM pin is pulled below 0.4V. AAM is used to optimize efficiency during light-load and no-load conditions.

When AAM is enabled, the MPQ2166A first enters nonsynchronous operation as the inductor current approaches zero at light-load. If the load decreases further or there is no load, this makes the internal COMP voltage ( $V_{COMP}$ ) decrease to the set value. Then the MPQ2166A enters AAM. In AAM, the internal clock is reset whenever  $V_{COMP}$  crosses over the set threshold, and the crossover time is used as the benchmark of the next clock. When the load increases and  $V_{COMP}$  exceeds the set value, the operation mode is in discontinuous conduction mode (DCM) or continuous conduction mode (CCM), which has a constant switching frequency.

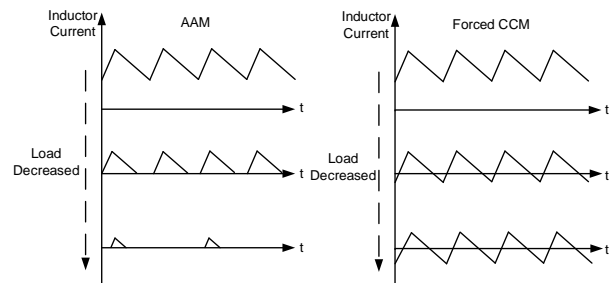

**Figure 3: AAM and Forced CCM Modes**

### Enable (EN)

EN is a digital control pin that turns the regulator on and off.

When EN is pulled below the falling threshold voltage (about 0.4V), the chip shuts down. Forcing EN above the rising threshold voltage (about 1.6V) turns on the part. Do not float the EN pin, since there is no internal resistor from EN to GND. If EN is floated, the status is uncertain which may lead to unexpected behavior.

### Soft Start (SS)

The MPQ2166A has a built-in soft start (SS) that ramps up the output voltage at a controlled slew rate, preventing overshoot at start-up. The default soft-start time is about 0.5ms.

The SS time ( $t_{SS}$ ) can be configured by an external capacitor connected to the SS pin.  $t_{SS}$  can be calculated with Equation (1):

$$t_{SS}(\text{ms}) = \frac{C_{SS}(\text{nF}) \times V_{REF}(\text{V})}{I_{SS}(\mu\text{A})} \quad (1)$$

Where  $C_{SS}$  is the external SS capacitor,  $V_{REF}$  is the internal reference voltage (0.6V), and  $I_{SS}$  is the 3.2 $\mu\text{A}$  SS charge current.

**Oscillator and SYNC Function**

The internal oscillator frequency is set by a single external resistor ( $R_{FREQ}$ ) connected between FREQ and ground. The frequency-setting resistor should be located close to the device. Figure 4 shows the relationship between the oscillator frequency and  $R_{FREQ}$ .

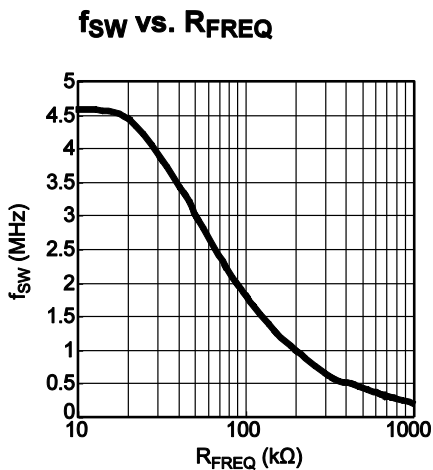

Figure 4: f<sub>sw</sub> vs. R<sub>FREQ</sub>

FREQ can also be used to synchronize the internal oscillator to an external clock. The rising edge of the channel 1 clock is synchronized to the external clock’s rising edge, while the channel 2 clock remains 180° out-of-phase to channel 1. The recommended external SYNC frequency is in the range of 350kHz to 3MHz. While there is no pulse width requirement, note that there is always parasitic capacitance on the pad. Therefore, if the pulse width is too short, a clear rising and falling edge may not be seen. It is recommended to make the pulse longer than 100ns.

Add the external SYNC clock (350kHz to 3MHz) before the device starts up, and ensure that the clock stays on until the device is off. Constant high, constant low, and high/low transitions for the SYNC signal are all not allowed during the operation.

**Power Good (PG)**

The MPQ2166A has one power good (PG) output to indicate normal operation after the soft-start time. PG is the open drain of an internal MOSFET. It should be connected to VIN, VCC, or an external voltage source through a resistor (e.g. 100kΩ). After the input voltage is applied, the MOSFET turns on, and PG is pulled to GND before SS is ready. After the FB voltage ( $V_{FB}$ ) reaches 90% of the reference voltage ( $V_{REF}$ ), the MOSFET turns off and PG is pulled high by an external voltage source. If  $V_{FB}$  drops below 82% of  $V_{REF}$ , the PG voltage is pulled to GND to indicate an output failure.

**Current Limit and Short Circuit**

Each channel of the MPQ2166A has a typical 4.8A current limit for the high-side switch. Once the inductor current reaches the current limit, the HS-FET turns off immediately. Then the LS-FET turns on to discharge the energy, and the inductor current decreases. The HS-FET does not turn on again until the inductor current drops below a current threshold (called the valley current limit). This protection prevents the inductor current from running away and damaging the components.

When  $V_{FB}$  drops below 60% of  $V_{REF}$  and soft start has finished, the MPQ2166A treats this as a short fault and attempts to recover with hiccup mode.

In hiccup mode, the MPQ2166A disables the output power stage, slowly discharges the soft-start capacitor, and soft starts automatically. If the short-circuit condition still remains, the MPQ2166A repeats this operation cycle until the short circuit is removed and the output rises back to regulation levels.

**LS Current Limit Protection**

The MPQ2166A has a -1A low-side (negative) current limit. Once the inductor current reaches the current limit, the low-side MOSFET (LS-FET) immediately turns off, and the high-side MOSFET (HS-FET) turns on. The current limit prevents the negative current from dropping too low and damaging the components.

### **Dropout Operation**

The MPQ2166A allows the HS-FET to remain on for more than one switching cycle, and increases the duty cycle while the input voltage drops down to the output voltage. When the duty cycle reaches 100%, the HS-FET remains on to deliver current to the output up to its current limit. The output voltage is then the difference between the input voltage and the voltage drop across the main switch and the inductor.

### **Thermal Shutdown**

The MPQ2166A employs thermal protection by internally monitoring the IC temperature. This function prevents the chip from operating at exceedingly high temperatures. If the junction temperature exceeds the threshold value (typically 175°C), the whole chip shuts down. There is a 40°C hysteresis. Once the junction temperature drops to about 135°C, the device resumes normal operation by initiating a soft start. This is a non-latch protection.

## APPLICATION INFORMATION

### Setting the Output Voltage

The external resistor divider sets the output voltage. The feedback resistor (R1) also sets the feedback loop bandwidth with the internal compensation. The T-type network is recommended. (see Figure 5).

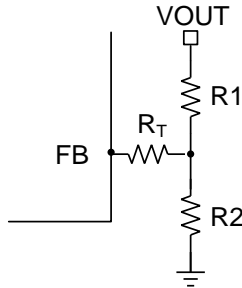

**Figure 5: T-Type Feedback Network**

$R_T$  and R1 are used to set the loop bandwidth. A lower  $R_T + R1$  value means a higher bandwidth. However, a high bandwidth may cause an insufficient phase margin, resulting in loop instability. Therefore, a proper  $R_T$  value is required to make a tradeoff between the bandwidth and phase margin. Table 1 lists the recommended feedback resistor and  $R_T$  values for output voltages.

**Table 1: Resistor Selection vs. Output Voltage Setting**

V <sub>OUT</sub> (V)	R <sub>T</sub> (kΩ)	R1 (kΩ)	R2 (kΩ)
1.2	100	100	100
1.5	100	100	66.5
1.8	100	100	49.9
2.5	100	100	31.6
3.3	100	100	22.1

If R1 is estimated to be 100kΩ, R2 can then be calculated with Equation (2):

$$R2 = \frac{R1}{\frac{V_{OUT}}{0.6V} - 1} \quad (2)$$

If ceramic capacitors are used as output capacitors ( $C_O$ ), the feedback loop bandwidth ( $f_c$ ) should not exceed 1/10 of the switching frequency for optimal transient performance and good phase margin. If an electrolytic capacitor is used,  $f_c$  should not exceed 1/4 of the ESR zero frequency ( $f_{ESR}$ ).

$f_{ESR}$  can be calculated with Equation (3):

$$f_{ESR} = \frac{1}{2\pi \times R_{ESR} \times C_O} \quad (3)$$

For example, choose  $f_c = 80\text{kHz}$  with a ceramic capacitor when  $C_O = 22\mu\text{F}$ .

### Selecting the Inductor

An inductor with a DC current rating at least 25% greater than the maximum load current is recommended for most applications. For the best efficiency, the inductor DC resistance should be below 20mΩ. For most designs, the inductance value can be estimated with Equation (4):

$$L = \frac{V_{OUT} \times (V_{IN} - V_{OUT})}{V_{IN} \times \Delta I_L \times f_{SW}} \quad (4)$$

Where  $\Delta I_L$  is inductor ripple current. Choose the inductor ripple current to be approximately 30% of the maximum load current.

The maximum inductor peak current can be calculated with Equation (5):

$$I_{L(MAX)} = I_{LOAD} + \frac{\Delta I_L}{2} \quad (5)$$

### Selecting the Input Capacitor

The input capacitor reduces the surge current drawn from the input and the switching noise from the device. The input capacitor impedance at the switching frequency should be less than the input source impedance to prevent high-frequency switching current from passing to the input source. Ceramic capacitors with X5R or X7R dielectrics are highly recommended because of their low ESR and small temperature coefficients. For most applications, a 22μF capacitor is sufficient.

### Selecting the Output Capacitor

The output capacitor ( $C_O$ ) keeps the output voltage ripple small and ensures a stable regulation loop. The output capacitor impedance should be low at the switching frequency. Use ceramic capacitors with X5R or X7R dielectrics. If an electrolytic capacitor is used, pay close attention to the output ripple voltage, extra heating, and the selection of the



upper feedback resistor due to the large ESR of electrolytic capacitor (see the Setting the Output Voltage section on page 24). The output ripple ( $\Delta V_{OUT}$ ) can be calculated with Equation (6):

$$\Delta V_{OUT} = \frac{V_{OUT} \times (V_{IN} - V_{OUT})}{V_{IN} \times L \times f_{SW}} \times \left( ESR + \frac{1}{8 \times f_{SW} \times C_O} \right) \quad (6)$$

### Power Dissipation

IC power dissipation is important in circuit design, not only because of efficiency concerns, but also because of the chip's thermal requirements. Several parameters influence power dissipation, such as conduction loss ( $P_{COND}$ ), dead time ( $P_{DT}$ ), switching loss ( $P_{SW}$ ), MOSFET driver current ( $P_{DR}$ ), and supply current ( $P_S$ ).

Based on these parameters, the total power loss can be estimated with Equation (7):

$$P_{LOSS} = P_{COND} + P_{DT} + P_{SW} + P_{DR} + P_S \quad (7)$$

### Thermal Regulation

Changes in IC temperature can change the electrical characteristics, especially when the temperature exceeds the IC's recommended operating range. Managing the IC's temperature requires additional considerations to ensure that the IC runs within the maximum allowable temperature junction.

Specific layout designs can improve the thermal profile while limiting losses to both efficiency and the device's operating range.

For the MPQ2166A, connect the ground pin on the package to a ground plane on top of the PCB, and use this plane as a heatsink. Connect this ground plane to the ground planes beneath the IC using vias to improve heat dissipation. However, given that these ground planes can introduce unwanted EMI noise and occupy valuable PCB space, design their size and shape to match the thermal resistance requirement.

Connecting the ground pin to a heatsink cannot guarantee that the IC will not exceed its recommended temperature limits (i.e. the ambient temperature exceeds the IC's temperature limits). If the ambient air temperature approaches the IC's temperature limit, the IC can be derated to operate using less power, and help prevent thermal damage and unwanted electrical characteristics.

**PCB Layout Guidelines <sup>(7)</sup>**

Efficient PCB layout is critical for stable operation. A 4-layer layout is strongly recommended to improve thermal performance. For the best results, refer to Figure 6 and follow the guidelines below:

1. Connect PGND1 and PGND2 together at PGND.
2. Place the high-current paths (PGND, VIN, and SW) very close to the device with short, direct, and wide traces.
3. Place input capacitors on both VIN sides, as close to VIN and PGND as possible.
4. Place the decoupling capacitor as close to VCC and AGND as possible.
5. Keep the switching node (SW) short, and route it away from the feedback network.
6. Place the external feedback resistors next to FB. Do not place vias on the FB trace.
7. Connect PGND to a large copper area to improve thermal performance.

**Note:**

- 7) The recommended PCB layout is based on Figure 7.

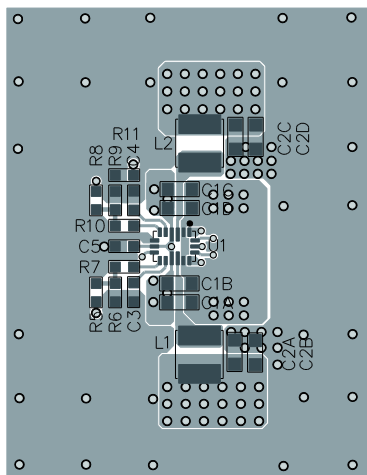
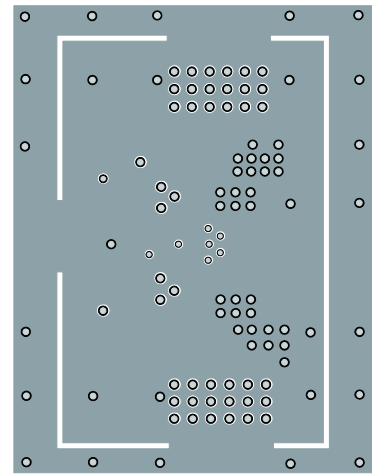
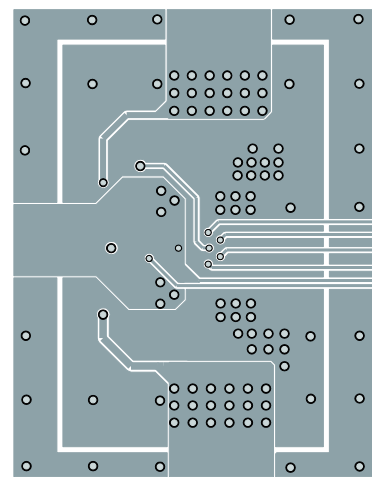
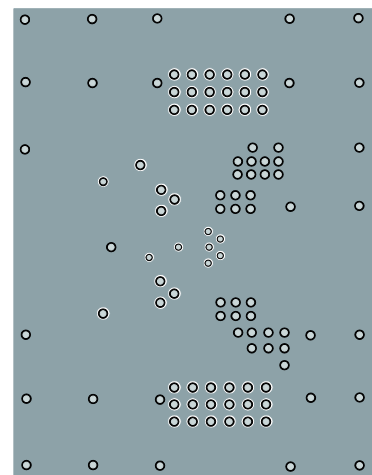
**Top Layer**

**Inner Layer 1**

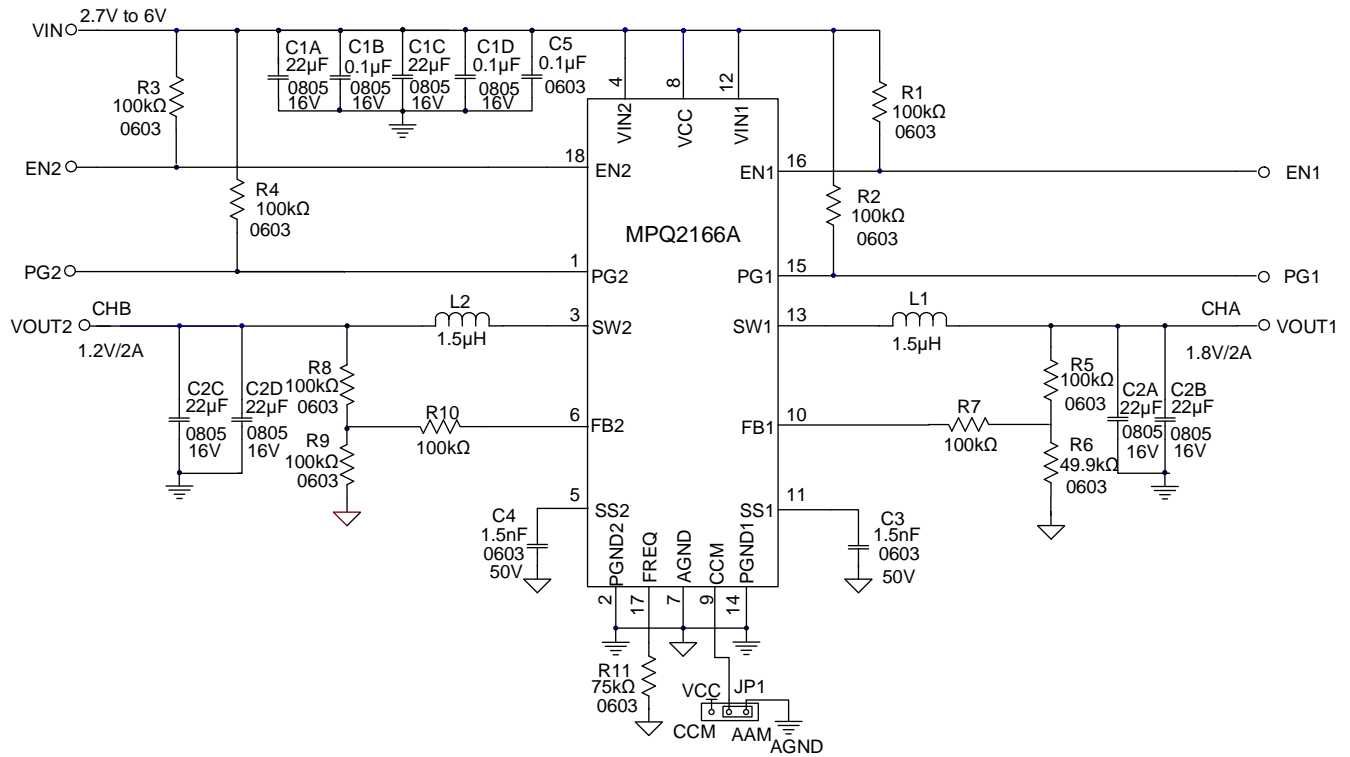
**Inner Layer 2**

**Bottom Layer**
**Figure 6: Recommended PCB Layout**

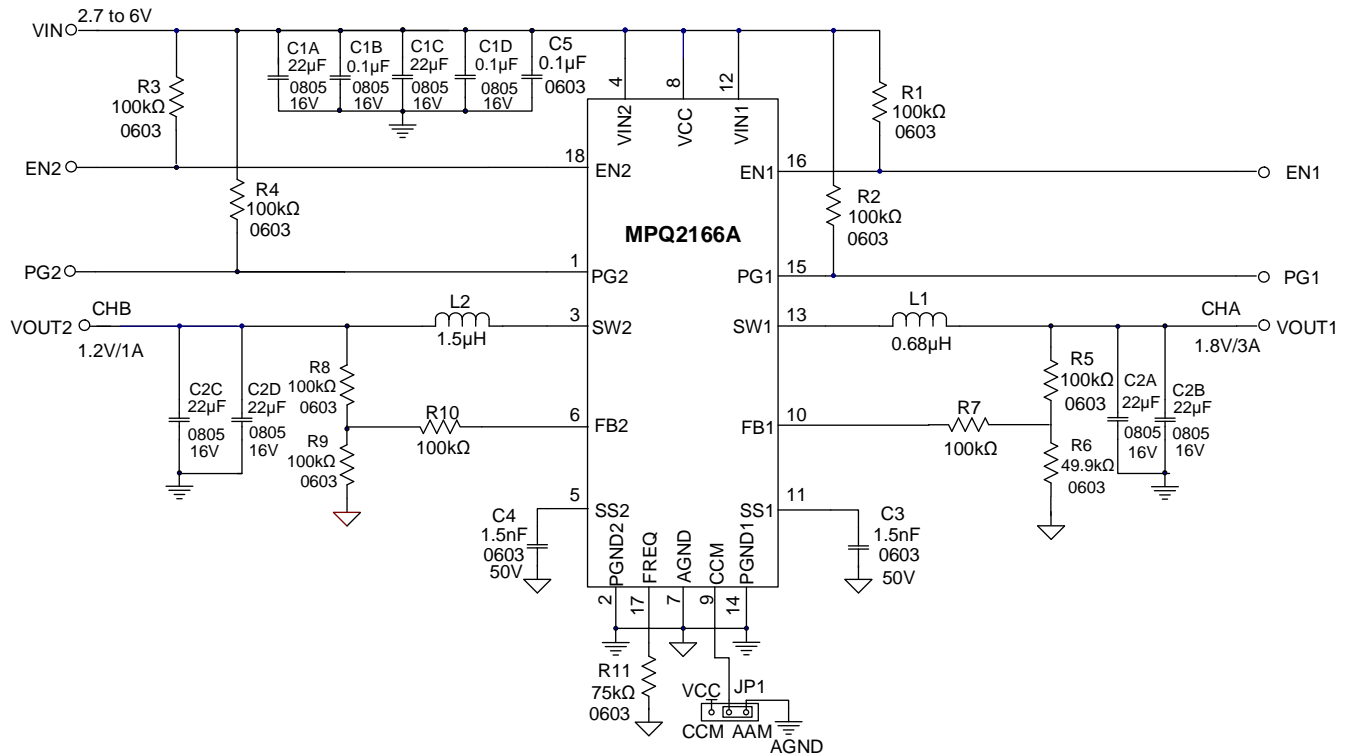
**TYPICAL APPLICATION CIRCUITS**



**Figure 7: 2A/2A Application Circuit**

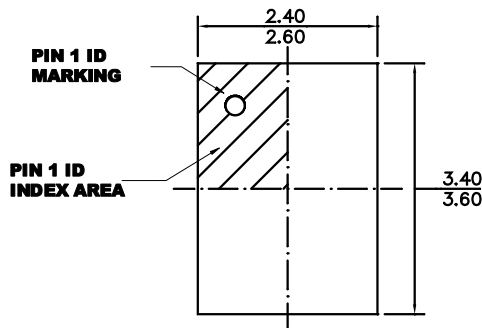

**Figure 8: 3A/1A Application Circuit**

## PACKAGE INFORMATION

### QFN-18 (2.5mmx3.5mm)

#### Wettable Flank



**TOP VIEW**

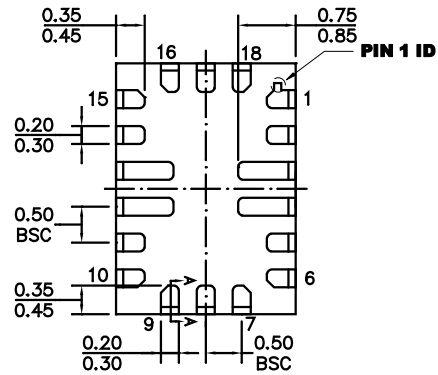

**BOTTOM VIEW**

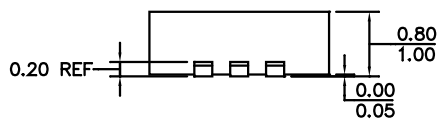

**SIDE VIEW**

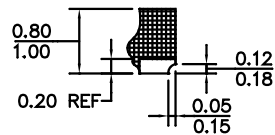

**SECTION A-A**

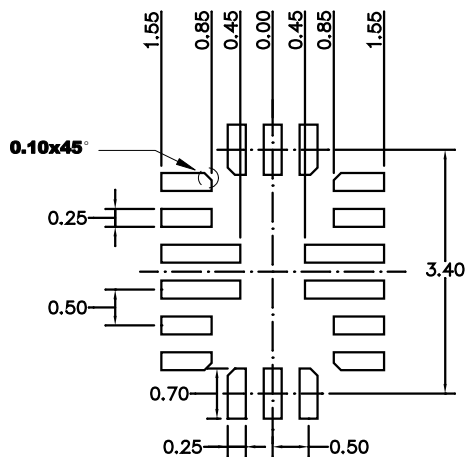

**RECOMMENDED LAND PATTERN**

#### NOTE:

- 1) THE LEAD SIDE IS WETTABLE.
- 2) LAND PATTERNS OF PINS 3, 4, 12, AND 13 HAVE THE SAME LENGTH AND WIDTH.
- 3) ALL DIMENSIONS ARE IN MILLIMETERS.
- 4) LEAD COPLANARITY SHALL BE 0.08 MILLIMETERS MAX.
- 5) JEDEC REFERENCE IS MO-220.
- 6) DRAWING IS NOT TO SCALE.

## CARRIER INFORMATION

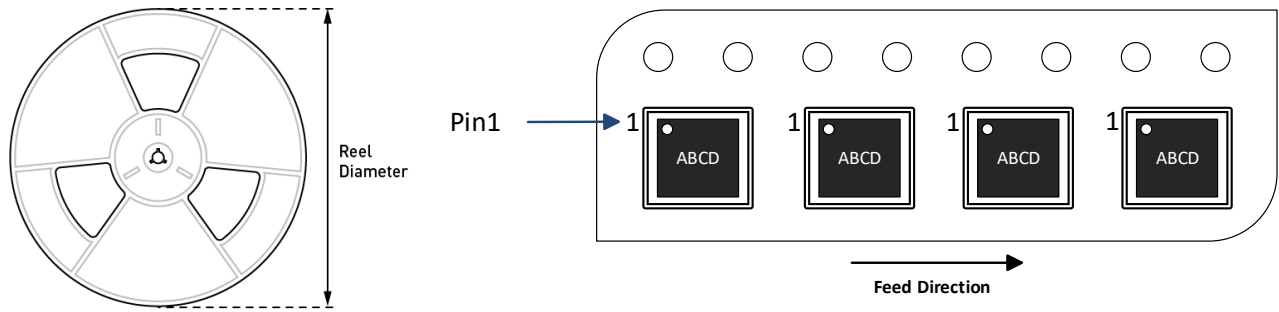

Part Number	Package Description	Quantity/ Reel	Quantity/ Tube <sup>(8)</sup>	Reel Diameter	Carrier Tape Width	Carrier Tape Pitch
MPQ2166AGRHE-AEC1-Z	QFN-18 (2.5mmx3.5mm)	5000	N/A	13in	12mm	8mm

**Note:**

8) N/A indicates "not available" in tubes. For 500-piece tape & reel prototype quantities, contact the factory. (Order code for 500-piece partial reel is "-P", tape & reel dimensions same as full reel.)