



MPQ2169B

6V, Dual 1.4A/1.4A or 2A/0.8A, Low- I_Q ,
Synchronous Buck with PG and SS,
AEC-Q100 Qualified

DESCRIPTION

The MPQ2169B is an internally compensated, dual, pulse-width modulation (PWM), synchronous step-down regulator that operates from a 2.7V to 6V input voltage (V_{IN}) and generates an output voltage (V_{OUT}) as low as 0.6V. The MPQ2169B can be configured as a 1.4A/1.4A or 2A/0.8A output current (I_{OUT}) regulator, and is ideal for powering portable equipment that runs on a single-cell Li-ion battery due to its low 65 μ A quiescent current (I_Q).

The MPQ2169B integrates dual, 60m Ω , high-side MOSFETs (HS-FETs) and 25m Ω synchronous rectifiers to achieve high efficiency without an external Schottky diode. The MPQ2169B offers peak current mode control and internal compensation, and is capable of low-dropout configurations. Both channels can operate at 100% duty cycle.

Full protection features include cycle-by-cycle current limiting and thermal shutdown.

The MPQ2169B requires a minimal number of readily available, standard external components, and is available in a QFN-18 (2.5mmx3.5mm) package.

FEATURES

- **Cooler Thermals:**
 - Below 20°C Operating Junction Temperature (T_J) Rise at 2A/0.8A, 2.3MHz
 - 90% Efficiency (5V to 1.8V, 2A, 2.3MHz)
 - Low-Ohmic BCD FET Technology
- **Low Noise EMI and EMC:**
 - MeshConnect™ Flip-Chip Package
 - Operates Outside of AM Radio Band
- **Reduces Board Size and BOM:**
 - Integrated Compensation Network
 - Available in a Small QFN-18 (2.5mmx3.5mm) Package
- **Additional Features:**
 - Power Good (PG) Output
 - External Soft Start (SS) and Tracking
 - Over-Current Protection (OCP) with Hiccup Mode
 - External Sync Clock
 - Forced Continuous Conduction Mode (FCCM)
 - 100% Duty Cycle Operation
 - Available in AEC-Q100 Grade 1

APPLICATIONS

- Automotive Infotainment
- Automotive Clusters
- Automotive Telematics
- Battery-Powered Devices
- Portable Instruments

All MPS parts are lead-free, halogen-free, and adhere to the RoHS directive. For MPS green status, please visit the MPS website under Quality Assurance. "MPS", the MPS logo, and "Simple, Easy Solutions" are trademarks of Monolithic Power Systems, Inc. or its subsidiaries.

TYPICAL APPLICATION

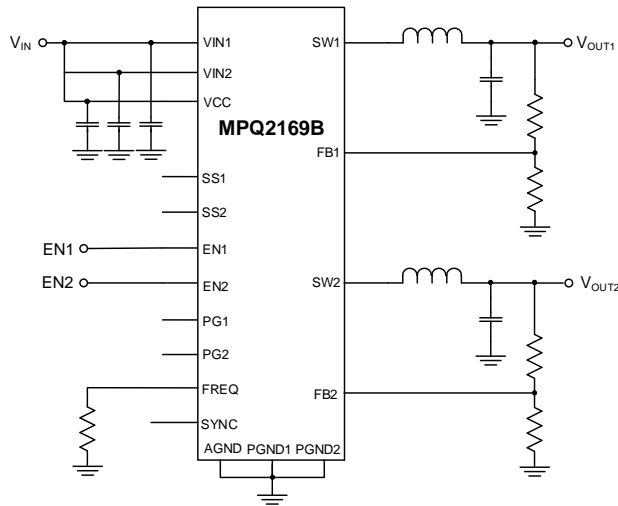

Efficiency vs. Load Current vs. Power Loss

$V_{OUT1} = 1.8V$, $L1 = 1.5\mu H$, $f_{sw} = 2.3MHz$, one channel on

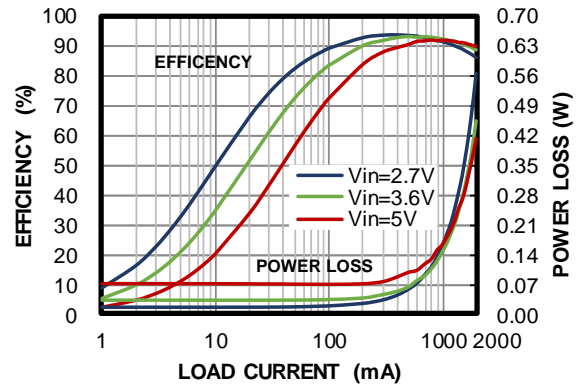

ORDERING INFORMATION

| Part Number* | Package | Top Marking | MSL Rating** |
|----------------------|----------------------|-------------|--------------|
| MPQ2169BGRHE-AEC1*** | QFN-18 (2.5mmx3.5mm) | See Below | 1 |

* For Tape & Reel, add suffix -Z (e.g. MPQ2169BGRHE-AEC1-Z).

** Moisture Sensitivity Level Rating

*** Wettable Flank

TOP MARKING

BRB

YWW

LLL

BRB: Product code of MPQ2169BGRHE-AEC1

Y: Year code

WW: Week code

LLL: Lot number

PACKAGE REFERENCE

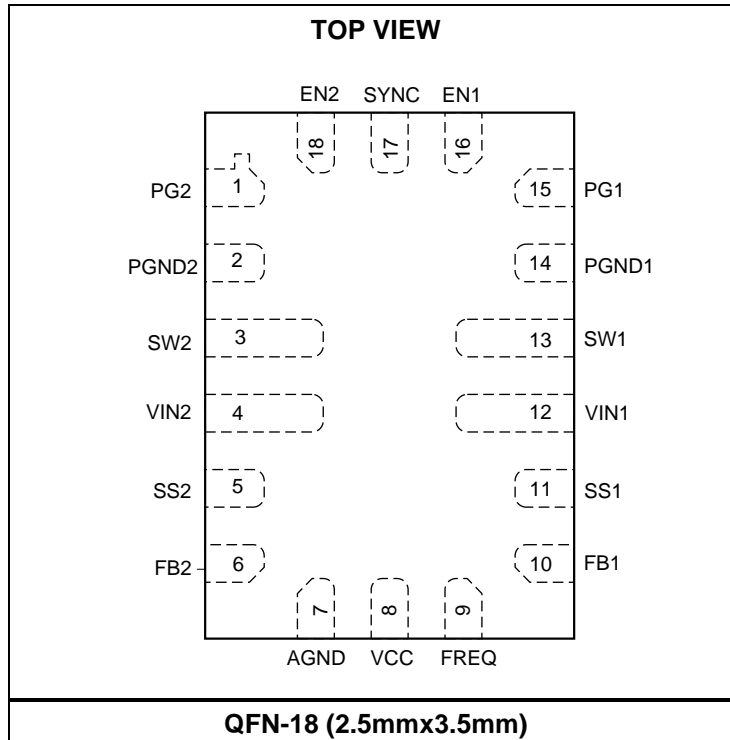

PIN FUNCTIONS

| Pin # | Name | Description |
|-------|-------|--|
| 1 | PG2 | Power good indicator for channel 2. The output of PG2 is an open drain. A pull-up resistor to the power source is required if this pin is used. PG2 is pulled high when V_{FB2} reaches 90% of the reference voltage (V_{REF}), and is pulled low to GND if V_{FB2} drops to 82% of V_{REF} . |
| 2 | PGND2 | Power ground for channel 2. Connect PGND2 to the negative terminals of the input and output capacitors with larger copper areas. PGND2 must be connected to PGND1 externally on the board. |
| 3 | SW2 | Switch-node connection to the inductor for channel 2. SW2 connects to the internal high-side MOSFETs (HS-FETs) and low-side MOSFETs (LS-FETs) of the channel 2 buck converter. |
| 4 | VIN2 | Input supply for channel 2. Place a decoupling capacitor to ground, close to VIN2, to reduce switching spikes. |
| 5 | SS2 | Soft start for channel 2. Place a capacitor from SS2 to GND to set the soft-start time (t_{ss}) externally. Floating this pin activates the internal default 0.5ms soft-start setting. |
| 6 | FB2 | Feedback for channel 2. FB2 is the input to the error amplifier (EA) of channel 2. An external resistor divider connects FB2 between the output and ground. The voltage on FB2 is compared to the internal 0.6V V_{REF} to set the regulation voltage for channel 2. |
| 7 | AGND | Analog ground. Connect AGND to PGND1 and PGND2 externally on the board. |
| 8 | VCC | Power supply to the internal regulator for both channels. Decouple VCC with a 0.1 μ F to 1 μ F capacitor, placed between VCC and AGND. Connect VIN1, VIN2, and VCC together externally. It is not recommended to power them from a separate power supply. |
| 9 | FREQ | Frequency set. Connect a resistor to GND to set the switching frequency (f_{sw}). |
| 10 | FB1 | Feedback for channel 1. FB1 is the input to the EA of channel 1. An external resistor divider connects FB1 between the output and GND. The voltage on FB1 is compared to the internal 0.6V V_{REF} to set the regulation voltage for channel 1. |
| 11 | SS1 | Soft start for channel 1. Place a capacitor from SS1 to GND to set t_{ss} externally. Floating this pin activates the internal default 0.5ms soft-start setting. |
| 12 | VIN1 | Input supply for channel 1. Place a decoupling capacitor to ground, close to VIN1, to reduce switching spikes. |
| 13 | SW1 | Switch-node connection to the inductor for channel 1. SW1 connects to the internal HS-FETs and LS-FETs of the channel 1 buck converter. |
| 14 | PGND1 | Power ground for channel 1. Connect PGND1 to the negative terminals of the input and output capacitors with larger copper areas. PGND1 must be connected to PGND2 externally on the board. |
| 15 | PG1 | Power good for channel 1. The output of PG1 is an open drain. A pull-up resistor to the power source is required if this pin is used. PG1 is pulled high when V_{FB1} reaches 90% of V_{REF} , and is pulled low to GND if V_{FB1} drops to 82% of V_{REF} . |
| 16 | EN1 | Enable control for channel 1. Pull EN1 below the specified threshold (0.8V) to shut down the chip. Pull EN above the threshold (0.9V) to enable the chip. Do not float EN1. |
| 17 | SYNC | Frequency sync. f_{sw} can be synchronized by an external clock via the SYNC pin. |
| 18 | EN2 | Enable control for channel 2. Pull EN2 below the specified threshold (0.8V) to shut down the chip. Pull EN above the threshold (0.9V) to enable the chip. Do not float EN2. |

ABSOLUTE MAXIMUM RATINGS ⁽¹⁾

| | |
|---|--------------------------|
| Supply voltage (V_{IN}) | 6.5V |
| V_{SW} | -0.3V to $V_{IN} + 0.3V$ |
| All other pins | -0.3V to +6.5V |
| Junction temperature | 150°C |
| Lead temperature | 260°C |
| Storage temperature | -65°C to +150°C |
| Continuous power dissipation ($T_A = 25^\circ\text{C}$) ⁽²⁾ ⁽⁶⁾ | |
| QFN-18 (2.5mmx3.5mm) | 3.6W |

ESD Ratings

| | |
|----------------------------|--------------------------|
| Human body model (HBM) | Class 2 ⁽³⁾ |
| Charged device model (CDM) | Class C2b ⁽⁴⁾ |

Recommended Operating Conditions

| | |
|--|-----------------|
| Supply voltage (V_{IN}) | 2.7V to 6V |
| Output voltage (V_{OUT}) | 0.6V to 5.5V |
| Operating junction temp (T_J) ⁽⁵⁾ | |
| | -40°C to +125°C |

| Thermal Resistance | θ_{JA} | θ_{JC} |
|--------------------------------|---------------|---------------|
| QFN-18 (2.5mmx3.5mm) | | |
| JESD51-7 ⁽⁶⁾ | 50 | 12 |
| EVQ2169B-RH-00A ⁽⁷⁾ | 34.8 | 2.7 |

Notes:

- 1) Exceeding these ratings may damage the device.
- 2) The maximum allowable power dissipation is a function of the maximum junction temperature T_J (MAX), the junction-to-ambient thermal resistance, θ_{JA} , and the ambient temperature, T_A . The maximum allowable continuous power dissipation at any ambient temperature is calculated by P_D (MAX) = $(T_J$ (MAX) - T_A) / θ_{JA} . Exceeding the maximum allowable power dissipation can produce an excessive die temperature, which may cause the regulator to go into thermal shutdown. Internal thermal shutdown circuitry protects the device from permanent damage.
- 3) Per AEC-Q100-002.
- 4) Per AEC-Q100-011.
- 5) Operating devices at junction temperatures exceeding 125°C is possible. Contact MPS for details.
- 6) Measured on JESD51-7, 4-layer PCB. The values given in this table are only valid for comparison with other packages and cannot be used for design purposes. These values were calculated in accordance with JESD51-7, and simulated on a specified JEDEC board. They do not represent the performance obtained in an actual application.
- 7) Measured on a MPS standard EVB: a 4-layer, 6.35cmx6.35cm PCB with 2oz thick copper.

ELECTRICAL CHARACTERISTICS

$V_{IN} = 5V$, $T_J = -40^{\circ}C$ to $+150^{\circ}C$, typical values are at $T_J = 25^{\circ}C$, unless otherwise noted.

| Parameters | Symbol | Condition | Min | Typ | Max | Units |
|--|------------------|---|-------|------|-------|-------------|
| Quiescent supply current | I_Q | $V_{IN} = 5V$, $V_{EN} = 2V$, $V_{FB} = 0.65V$, no switching | | 65 | 100 | μA |
| Shutdown current | I_{SHDN} | $V_{EN} = 0V$, $T_J = 25^{\circ}C$ | | 0 | 0.2 | μA |
| | | $V_{EN} = 0V$ | | | 30 | μA |
| Input under-voltage lockout (UVLO) threshold | V_{UVLO} | V_{IN1} , V_{IN2} , V_{CC} rising | | 2.4 | 2.55 | V |
| Input UVLO hysteresis | V_{UVLO_HYS} | V_{IN1} , V_{IN2} , V_{CC} UVLO hysteresis | | 230 | | mV |
| Regulated FB voltage | V_{FB} | $T_J = 25^{\circ}C$ | 0.593 | 0.6 | 0.607 | V |
| | | $T_J = -40^{\circ}C$ to $+125^{\circ}C$ | 0.585 | 0.6 | 0.612 | V |
| FB input current | I_{FB} | $V_{FB} = 0.65V$ | | 0 | 150 | nA |
| EN high threshold | V_{EN_H} | | 0.7 | 0.9 | 1.1 | V |
| EN low threshold | V_{EN_L} | | 0.6 | 0.8 | 1 | V |
| EN threshold hysteresis | V_{EN_HYS} | | | 100 | | mV |
| EN input current | I_{EN} | $V_{EN} = 2V$ | | 0 | 150 | nA |
| | | $V_{EN} = 0V$ | | 0 | 100 | |
| High-side MOSFET (HS-FET) on resistance | R_{DSON_P} | $V_{IN} = 5V$ | | 60 | 100 | m Ω |
| Low-side MOSFET (LS-FET) on resistance | R_{DSON_N} | $V_{IN} = 5V$ | | 25 | 50 | m Ω |
| SW leakage current | I_{SW_LK} | $V_{EN} = 0V$, $V_{IN} = 6V$, $V_{SW} = 0V$ and $6V$, $T_J = 25^{\circ}C$ | -1 | 0 | +1 | μA |
| HS-FET current limit ⁽⁸⁾ | I_{HS_LIMIT} | Source | 3 | 4 | 6.2 | A |
| LS valley current limit ⁽⁸⁾ | I_{VALLEY} | | | 3.4 | | A |
| LS-FET current limit | I_{LS_LIMIT} | Sink | 1 | | | A |
| Switching frequency | f_{SW} | $R_{FREQ} = 560k\Omega$ | 350 | 410 | 470 | kHz |
| | | $R_{FREQ} = 75k\Omega$ | 1990 | 2290 | 2590 | |
| SYNC frequency range | f_{SYNC} | | 0.35 | | 3 | MHz |
| SYNC rising threshold | V_{SYNC_R} | | 1.95 | 2.15 | 2.35 | V |
| SYNC falling threshold | V_{SYNC_F} | | 1.5 | 1.7 | 1.9 | V |
| SYNC threshold hysteresis | V_{SYNC_HYS} | | | 450 | | mV |
| SYNC input current | I_{SYNC} | $V_{SYNC} = 5V$ | | 13 | | μA |
| Phase shift | | | | 180 | | degrees |
| Minimum on time ⁽⁸⁾ | t_{ON_MIN} | | | 55 | | ns |
| Minimum off time ⁽⁸⁾ | t_{OFF_MIN} | | | 50 | | ns |
| Maximum duty cycle | D_{MAX} | | | 100 | | % |
| Thermal shutdown threshold ⁽⁸⁾ | T_D | | | 175 | | $^{\circ}C$ |
| Thermal shutdown hysteresis ⁽⁸⁾ | T_{D_HYS} | | | 40 | | $^{\circ}C$ |
| Soft-start charging current | I_{SS} | $V_{SS} = 0V$ | 2 | 3.2 | 5 | μA |
| Power good (PG) rising threshold | $PGOOD_{VTH-HI}$ | | 0.85 | 0.9 | 0.95 | V_{FB} |
| PG falling threshold | $PGOOD_{VTH-LO}$ | | 0.77 | 0.82 | 0.87 | V_{FB} |
| PG rising deglitch time | t_{PGOOD_R} | | | 30 | | μs |
| PG falling deglitch time | t_{PGOOD_F} | | | 40 | | μs |

Note:

8) Not tested in production. Guaranteed by design and characterization.

TYPICAL CHARACTERISTICS

$V_{IN} = 5V$, $T_J = -40^{\circ}C$ to $+125^{\circ}C$, unless otherwise noted.

Quiescent Supply Current vs. Temperature

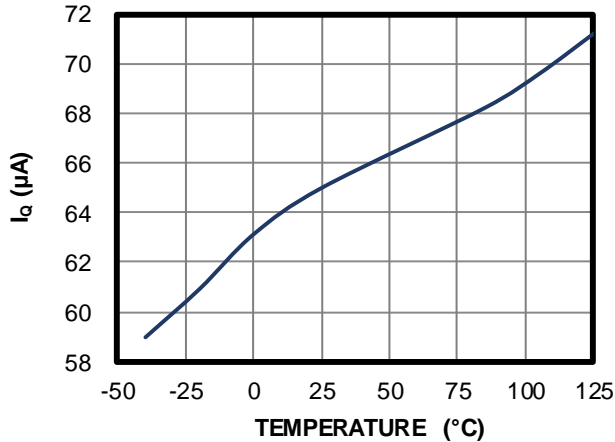

Regulated FB Voltage vs. Temperature

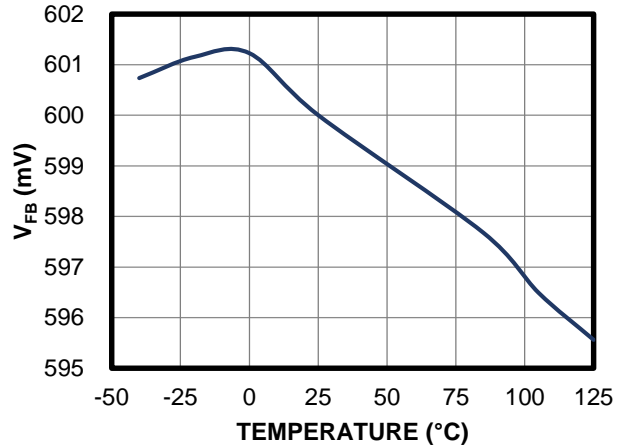

Switch Current Limit vs. Temperature

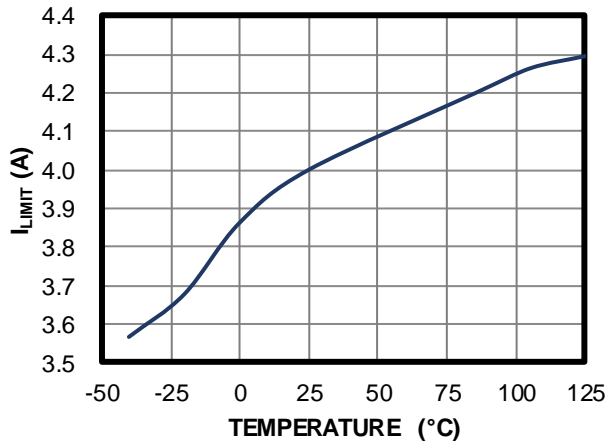

V_{IN} UVLO Rising Threshold vs. Temperature

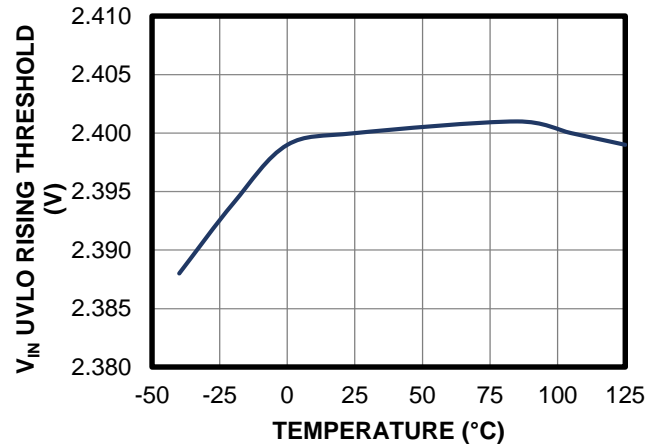

HS-FET On Resistance vs. Temperature

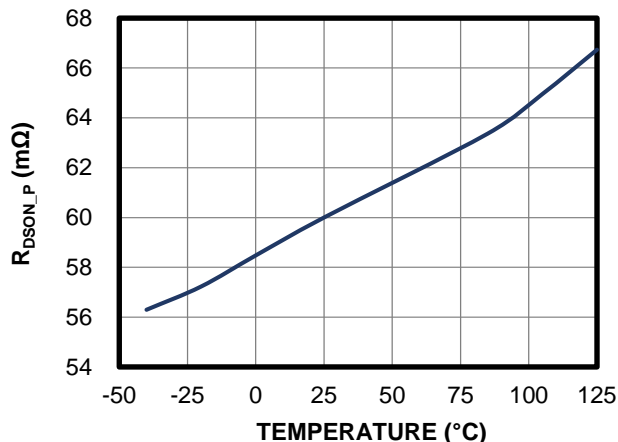

LS-FET On Resistance vs. Temperature

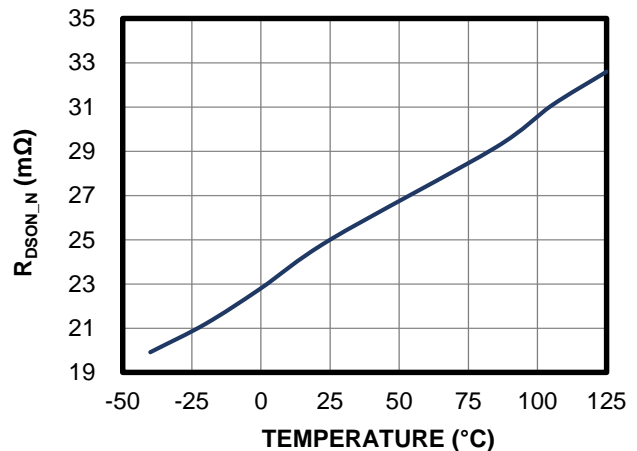

TYPICAL CHARACTERISTICS (continued)

$V_{IN} = 5V$, $T_J = -40^{\circ}C$ to $+125^{\circ}C$, unless otherwise noted.

PG Rising/Falling Threshold vs. Temperature

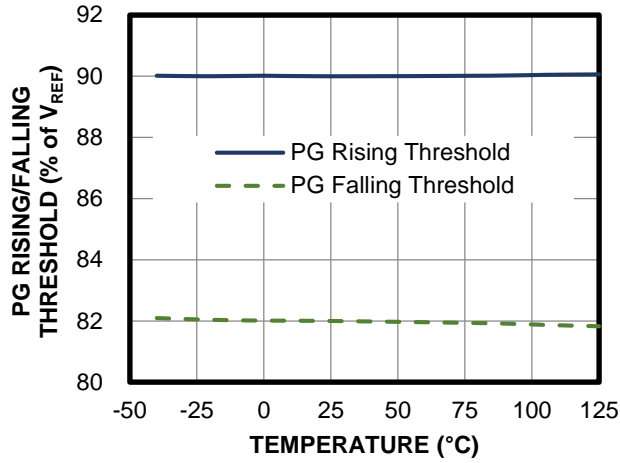

Frequency vs. Temperature

$f_{sw} = 410kHz$

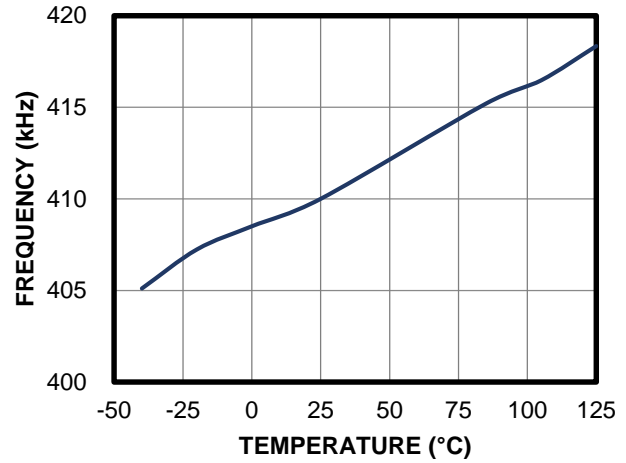

Frequency vs. Temperature

$f_{sw} = 2.29MHz$

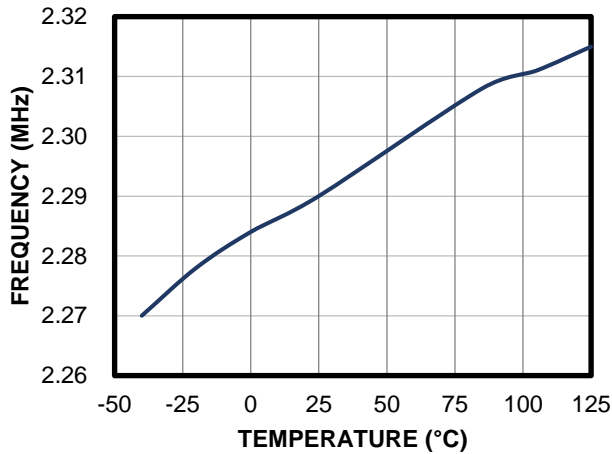

TYPICAL PERFORMANCE CHARACTERISTICS

$V_{IN} = 5V$, $V_{OUT1} = 1.8V$, $V_{OUT2} = 1.2V$, $L1 = L2 = 1.5\mu H$, $f_{SW} = 2.3MHz$, $T_A = 25^\circ C$, unless otherwise noted.

Efficiency vs. Load Current vs. Power Loss

$V_{OUT1} = 1.8V$, one channel on

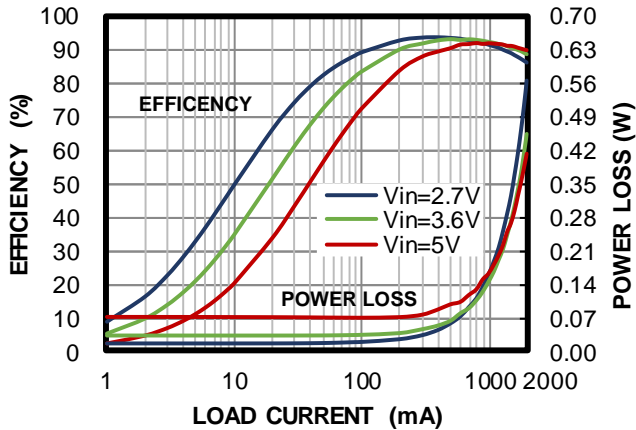

Efficiency vs. Load Current vs. Power Loss

$V_{OUT2} = 1.2V$, one channel on

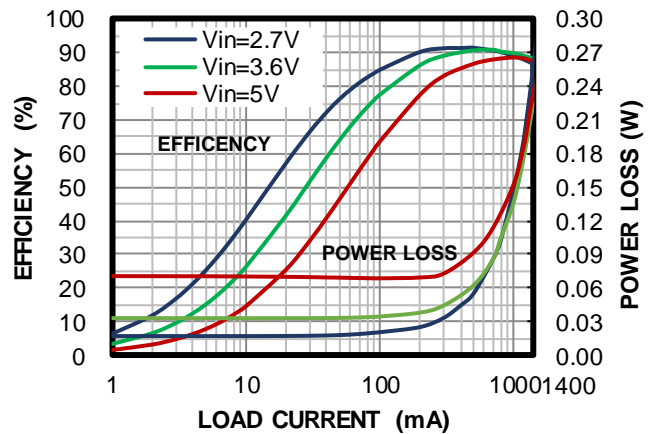

Load Regulation

$V_{OUT1} = 1.8V$, one channel on

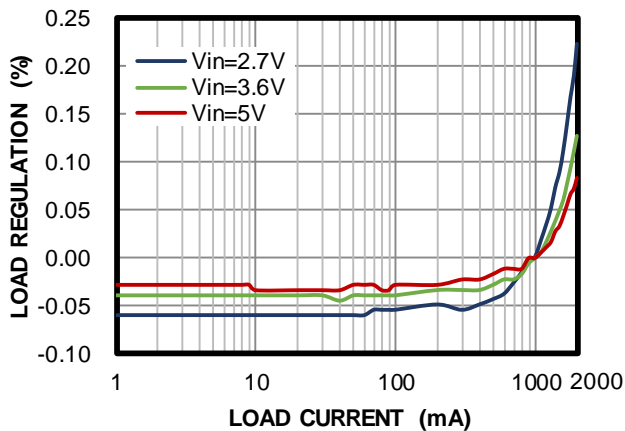

Load Regulation

$V_{OUT2} = 1.2V$, one channel on

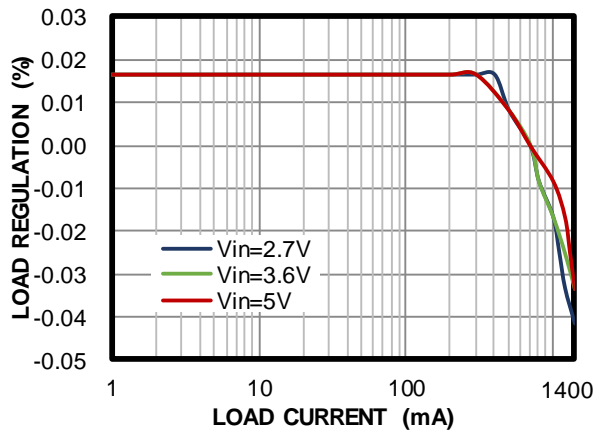

Line Regulation

$V_{OUT1} = 1.8V$, one channel on

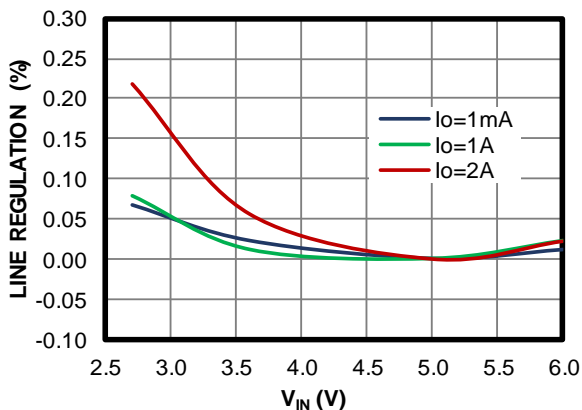

Line Regulation

$V_{OUT2} = 1.2V$, one channel on

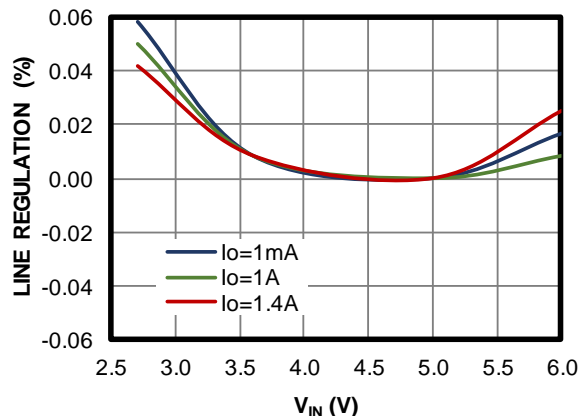

TYPICAL PERFORMANCE CHARACTERISTICS (continued)

$V_{IN} = 5V$, $V_{OUT1} = 1.8V$, $V_{OUT2} = 1.2V$, $L1 = L2 = 1.5\mu H$, $f_{sw} = 2.3MHz$, $T_A = 25^\circ C$, unless otherwise noted.

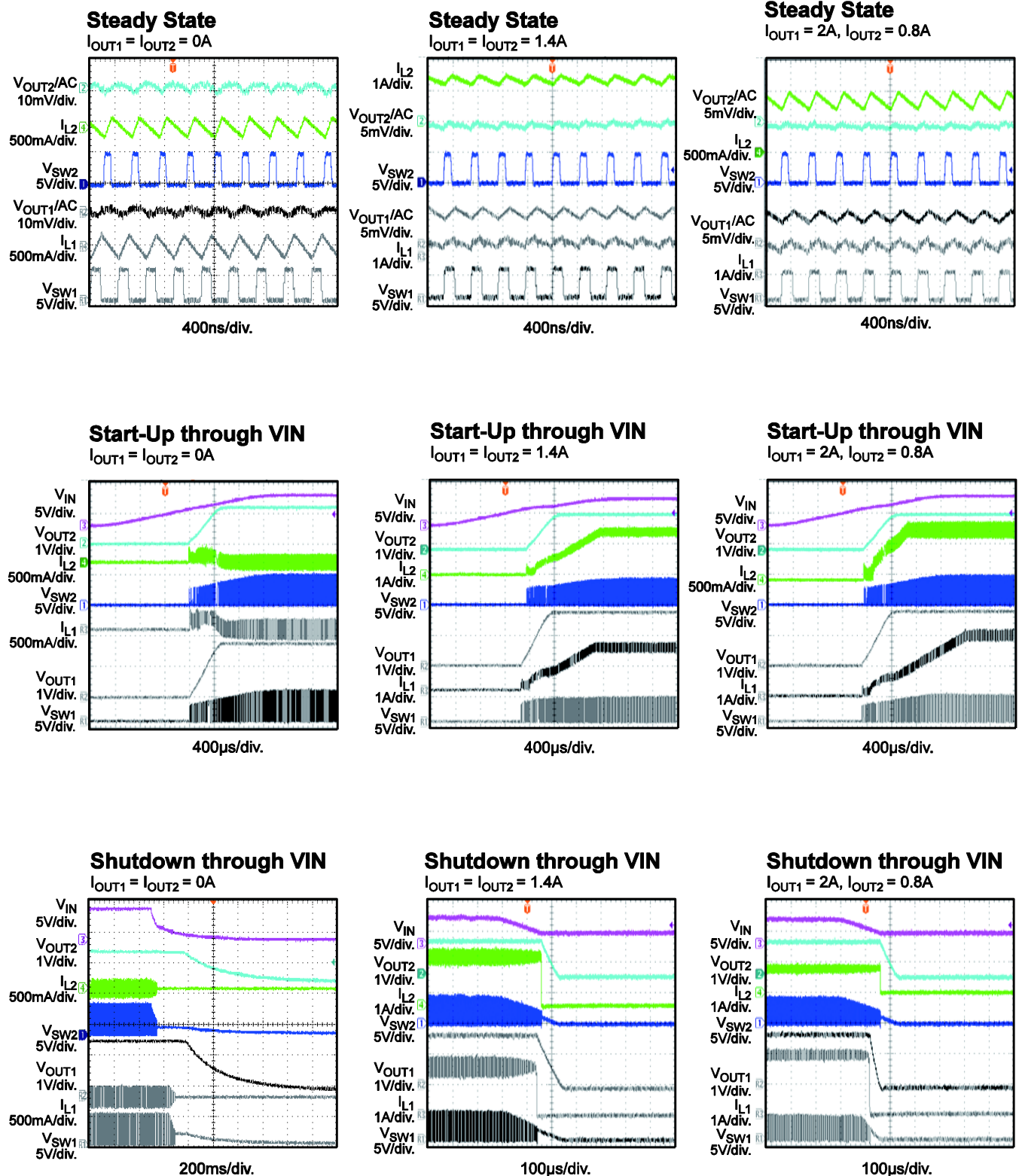

TYPICAL PERFORMANCE CHARACTERISTICS (continued)

$V_{IN} = 5V$, $V_{OUT1} = 1.8V$, $V_{OUT2} = 1.2V$, $L1 = L2 = 1.5\mu H$, $f_{SW} = 2.3MHz$, $T_A = 25^\circ C$, unless otherwise noted.

Start-Up through EN

$I_{OUT1} = I_{OUT2} = 0A$

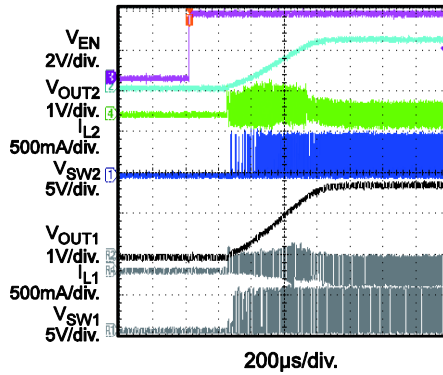

Start-Up through EN

$I_{OUT1} = I_{OUT2} = 1.4A$

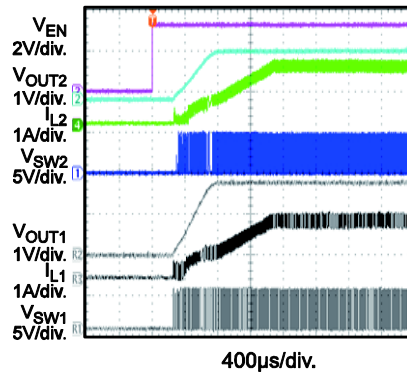

Start-Up through EN

$I_{OUT1} = 2A$, $I_{OUT2} = 0.8A$

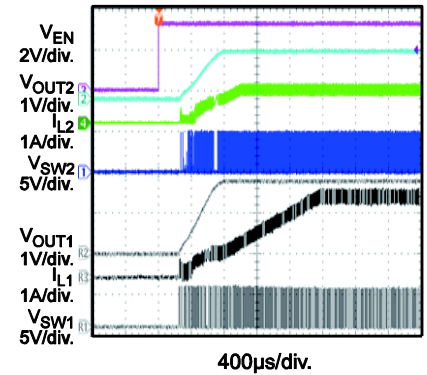

Shutdown through EN

$I_{OUT1} = I_{OUT2} = 0A$

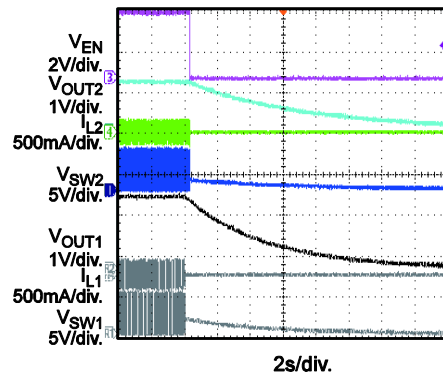

Shutdown through EN

$I_{OUT1} = I_{OUT2} = 1.4A$

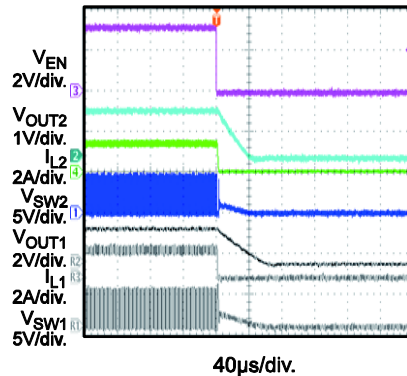

Shutdown through EN

$I_{OUT1} = 2A$, $I_{OUT2} = 0.8A$

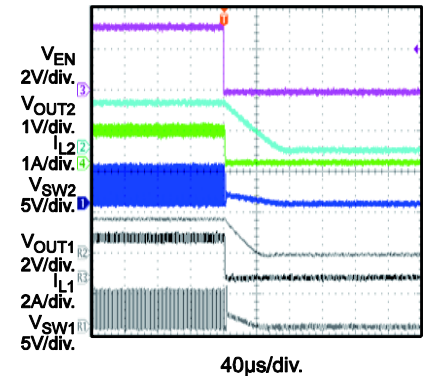

SCP Entry

$I_{OUT1} = I_{OUT2} = 0A$

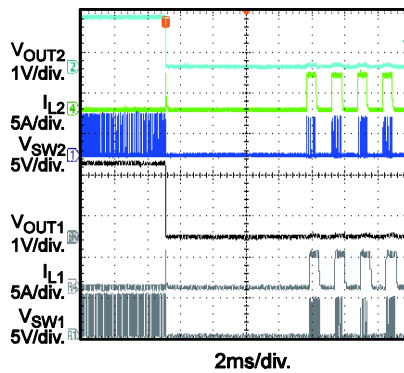

SCP Entry

$I_{OUT1} = I_{OUT2} = 1.4A$

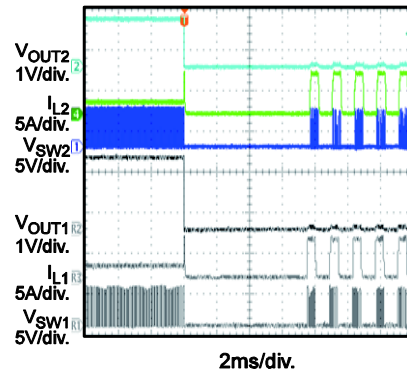

SCP Entry

$I_{OUT1} = 2A$, $I_{OUT2} = 0.8A$

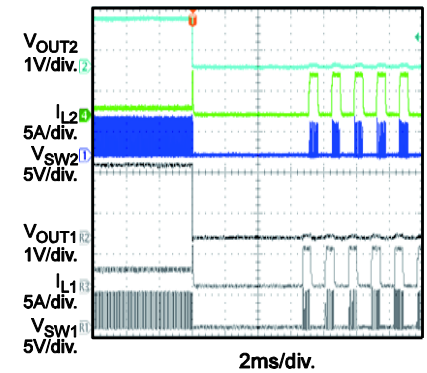

TYPICAL PERFORMANCE CHARACTERISTICS (continued)

$V_{IN} = 5V$, $V_{OUT1} = 1.8V$, $V_{OUT2} = 1.2V$, $L1 = L2 = 1.5\mu H$, $f_{sw} = 2.3MHz$, $T_A = 25^\circ C$, unless otherwise noted.

SCP Recovery

$I_{OUT1} = I_{OUT2} = 0A$

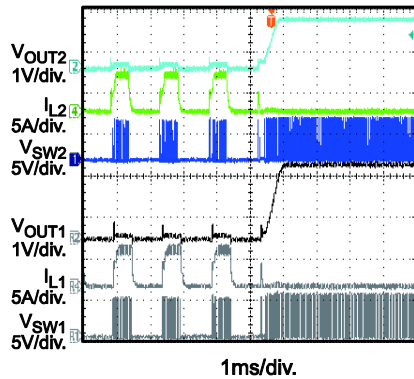

SCP Recovery

$I_{OUT1} = I_{OUT2} = 1.4A$

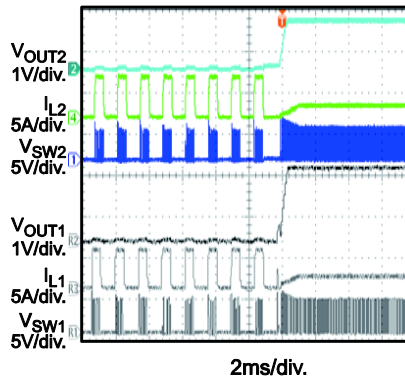

SCP Recovery

$I_{OUT1} = 2A$, $I_{OUT2} = 0.8A$

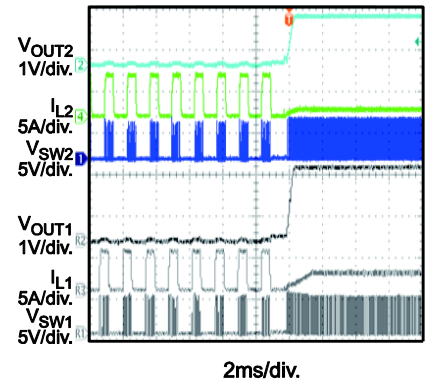

SCP Steady State

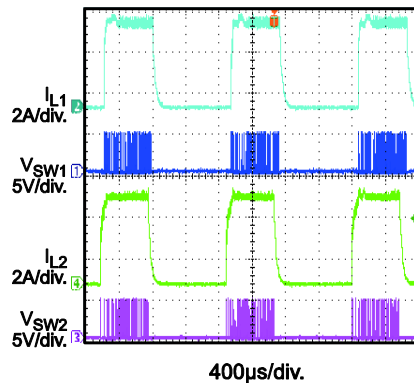

Load Transient

$I_{OUT1} = I_{OUT2} = 0.7A$ to $1.4A$,
 $1.6A/\mu s$ speed

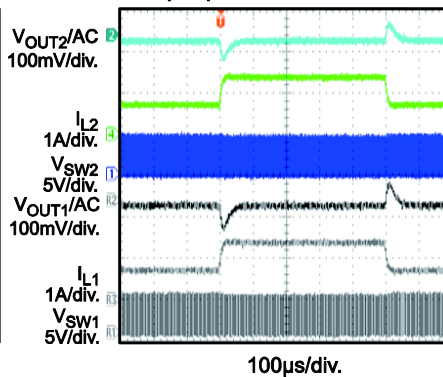

Load Transient

$I_{OUT1} = 1A$ to $2A$, $I_{OUT2} = 0.4A$ to $0.8A$,
 $1.6A/\mu s$ speed

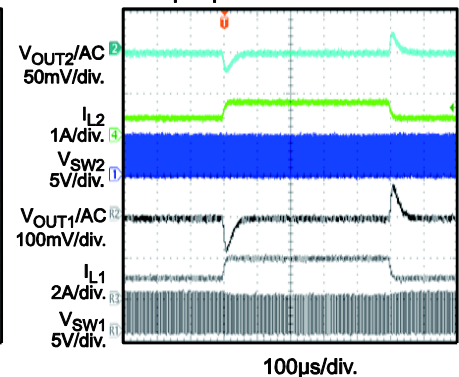

TYPICAL PERFORMANCE CHARACTERISTICS (continued)

$V_{IN} = 5V$, $V_{OUT1} = 1.8V$, $V_{OUT2} = 1.2V$, $L1 = L2 = 1.5\mu H$, $f_{SW} = 2.3MHz$, $T_A = 25^\circ C$, unless otherwise noted.

CH1 EN On, CH2 Steady State
 $I_{OUT1} = 1.4A$, $I_{OUT2} = 0A$

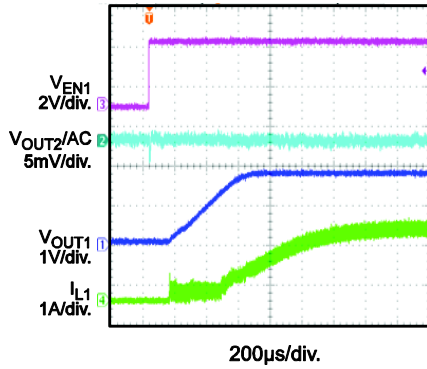

CH1 EN On, CH2 Steady State
 $I_{OUT1} = 1.4A$, $I_{OUT2} = 1.4A$

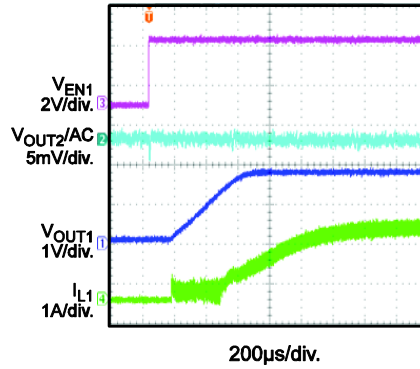

CH1 EN On, CH2 Steady State
 $I_{OUT1} = 2A$, $I_{OUT2} = 0.8A$

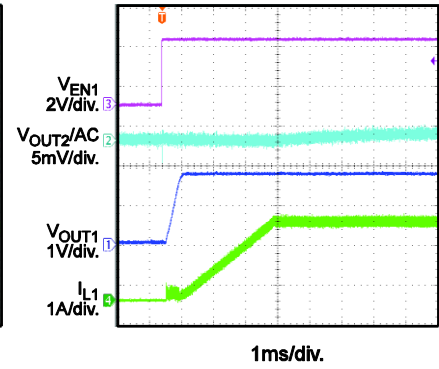

CH1 EN Off, CH2 Steady State
 $I_{OUT1} = 1.4A$, $I_{OUT2} = 0A$

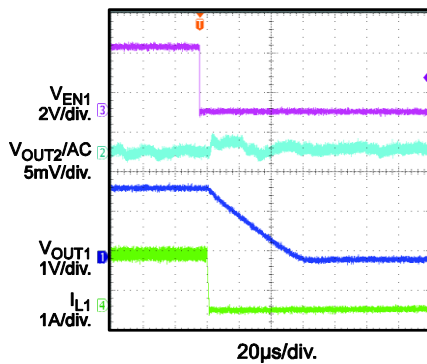

CH1 EN Off, CH2 Steady State
 $I_{OUT1} = 1.4A$, $I_{OUT2} = 1.4A$

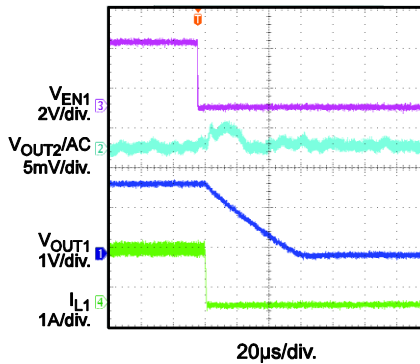

CH1 EN Off, CH2 Steady State
 $I_{OUT1} = 2A$, $I_{OUT2} = 0.8A$

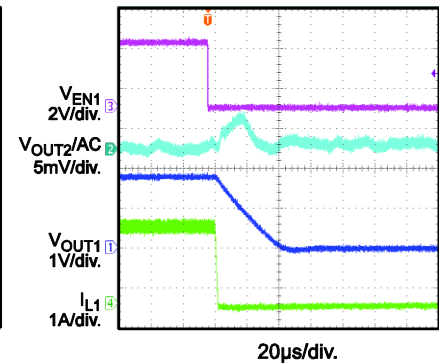

CH1 Steady State, CH2 EN On
 $I_{OUT1} = 0A$, $I_{OUT2} = 1.4A$

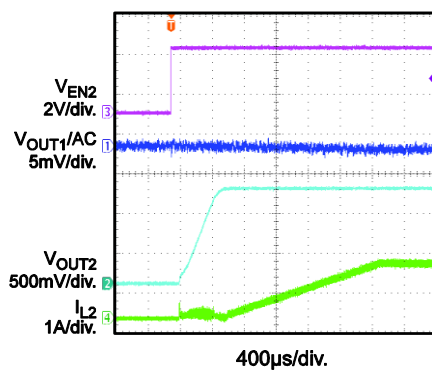

CH1 Steady State, CH2 EN On
 $I_{OUT1} = 1.4A$, $I_{OUT2} = 1.4A$

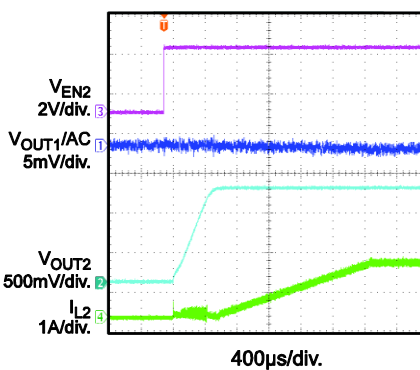

CH1 Steady State, CH2 EN On
 $I_{OUT1} = 2A$, $I_{OUT2} = 0.8A$

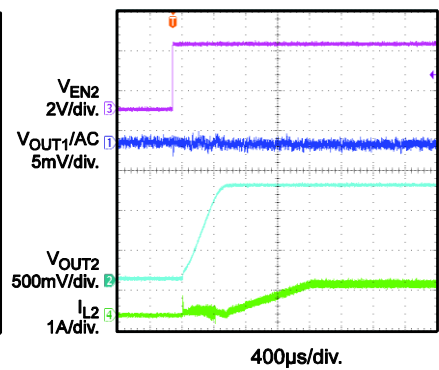

TYPICAL PERFORMANCE CHARACTERISTICS (continued)

$V_{IN} = 5V$, $V_{OUT1} = 1.8V$, $V_{OUT2} = 1.2V$, $L1 = L2 = 1.5\mu H$, $f_{SW} = 2.3MHz$, $T_A = 25^\circ C$, unless otherwise noted.

CH1 Steady State, CH2 EN Off

$I_{OUT1} = 0A$, $I_{OUT2} = 1.4A$

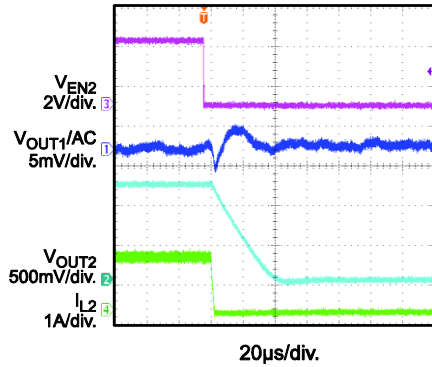

CH1 Steady State, CH2 EN Off

$I_{OUT1} = 1.4A$, $I_{OUT2} = 1.4A$

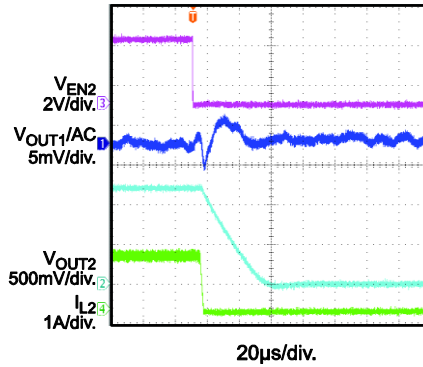

CH1 Steady State, CH2 EN Off

$I_{OUT1} = 2A$, $I_{OUT2} = 0.8A$

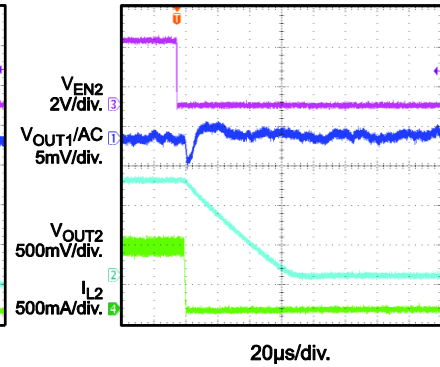

CH1 Load Transient, CH2 Steady State

$I_{OUT1} = 0A$ to $1.4A$, $1.6A/\mu s$ speed, $I_{OUT2} = 0A$

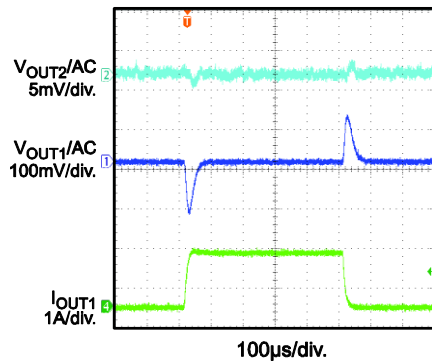

CH1 Load Transient, CH2 Steady State

$I_{OUT1} = 0A$ to $1.4A$, $1.6A/\mu s$ speed, $I_{OUT2} = 1.4A$

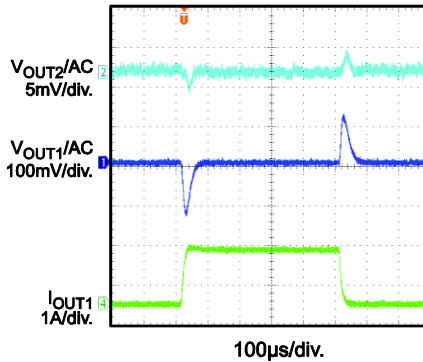

CH1 Load Transient, CH2 Steady State

$I_{OUT1} = 0A$ to $2A$, $1.6A/\mu s$ speed, $I_{OUT2} = 0.8A$

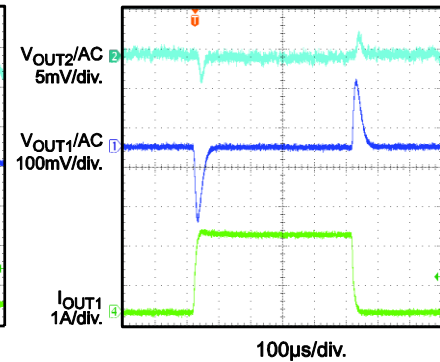

CH1 Steady State, CH2 Load Transient

$I_{OUT1} = 0A$, $I_{OUT2} = 0A$ to $1.4A$, $1.6A/\mu s$ speed

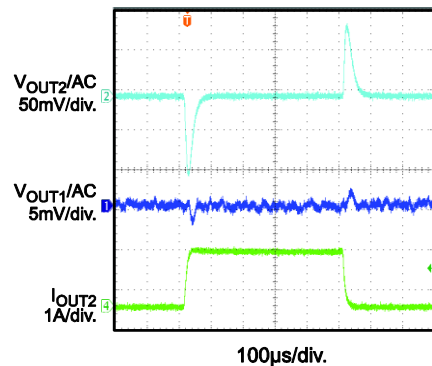

CH1 Steady State, CH2 Load Transient

$I_{OUT1} = 1.4A$, $I_{OUT2} = 0A$ to $1.4A$, $1.6A/\mu s$ speed

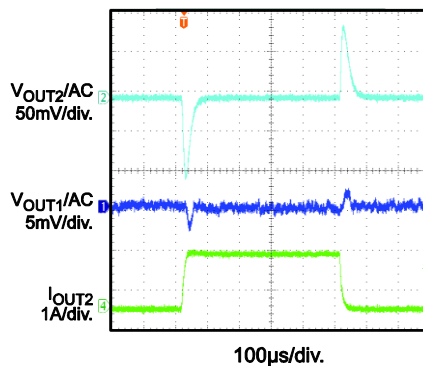

CH1 Steady State, CH2 Load Transient

$I_{OUT1} = 2A$, $I_{OUT2} = 0A$ to $0.8A$, $1.6A/\mu s$ speed

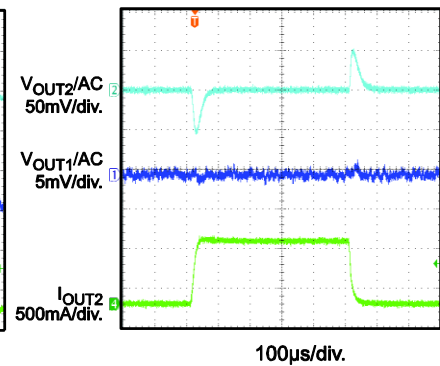

TYPICAL PERFORMANCE CHARACTERISTICS (continued)

$V_{IN} = 5V$, $V_{OUT1} = 1.8V$, $V_{OUT2} = 1.2V$, $L1 = L2 = 1.5\mu H$, $f_{sw} = 2.3MHz$, $T_A = 25^\circ C$, unless otherwise noted.

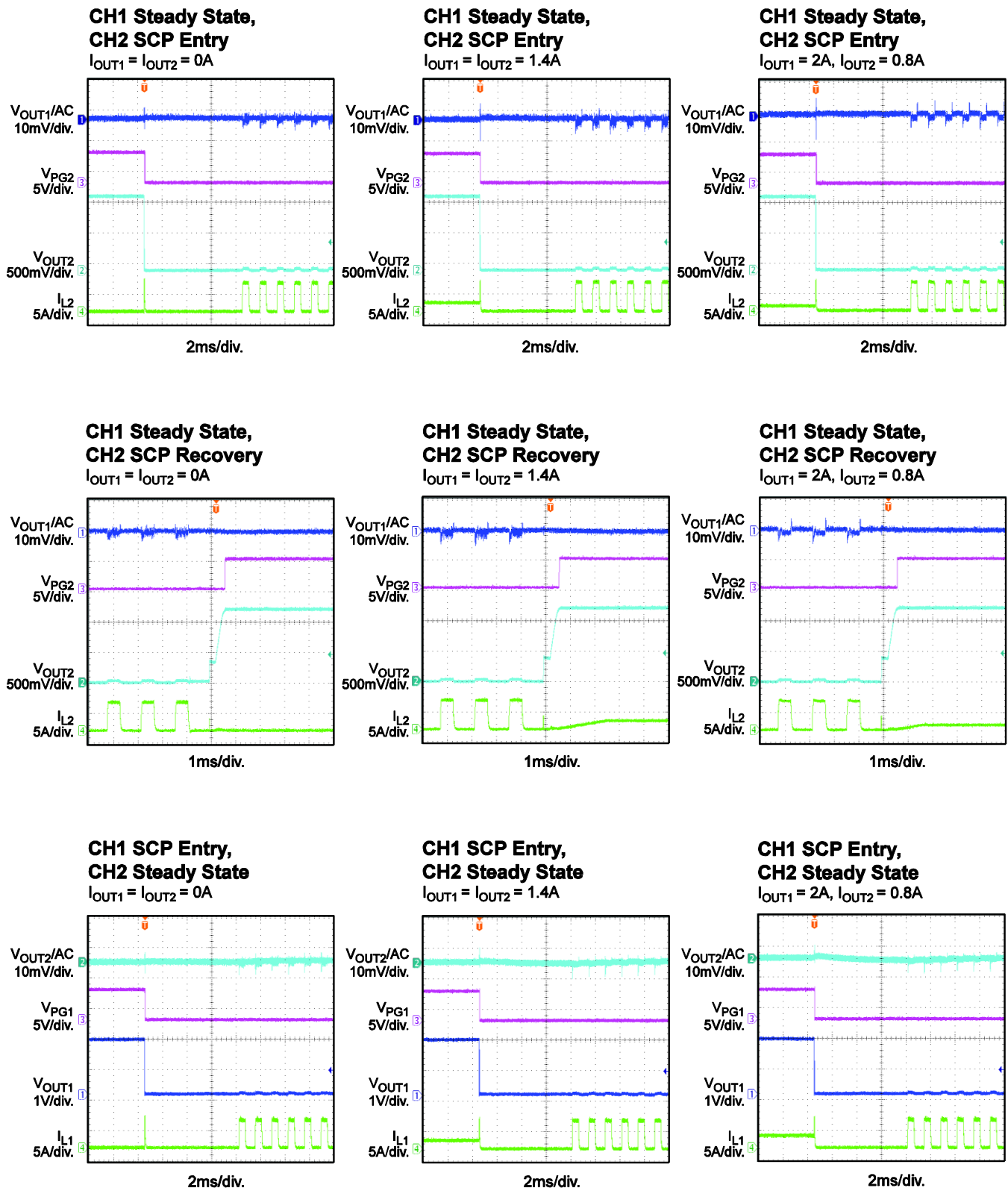

TYPICAL PERFORMANCE CHARACTERISTICS *(continued)*

$V_{IN} = 5V$, $V_{OUT1} = 1.8V$, $V_{OUT2} = 1.2V$, $L1 = L2 = 1.5\mu H$, $f_{SW} = 2.3MHz$, $T_A = 25^\circ C$, unless otherwise noted.

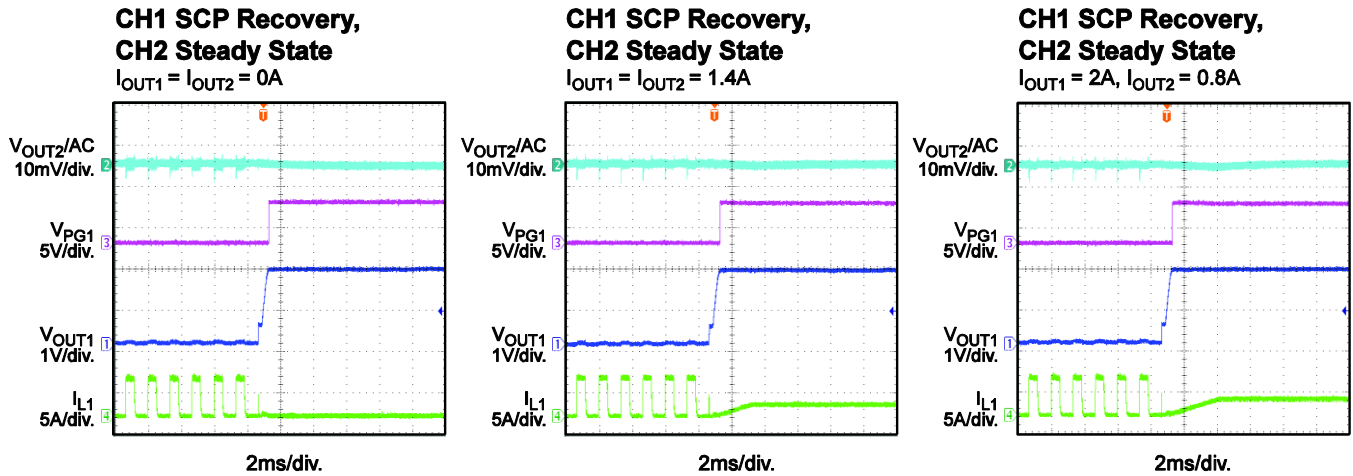

FUNCTIONAL BLOCK DIAGRAM

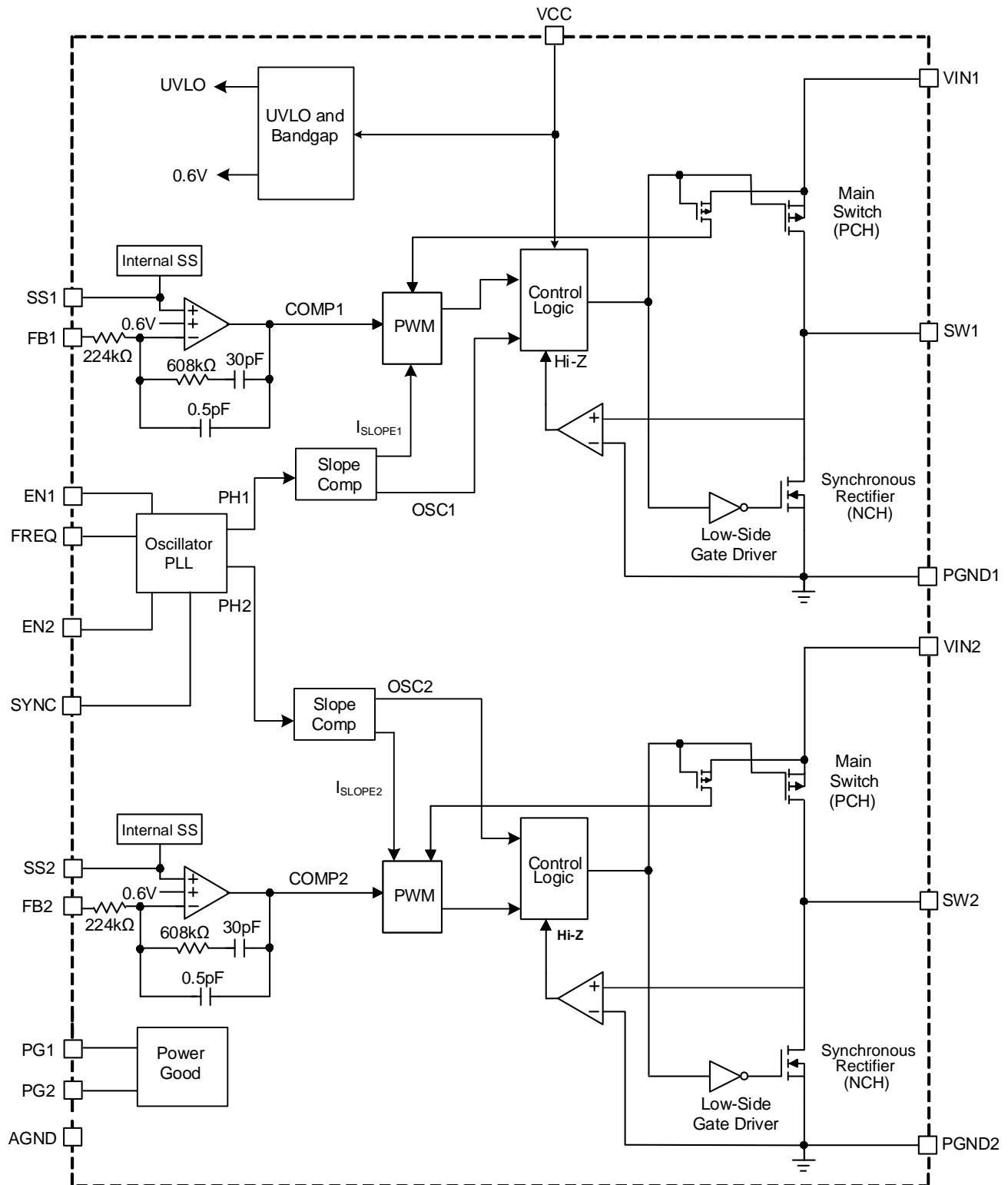

Figure 1: Functional Block Diagram

OPERATION

The MPQ2169B is a fully integrated, dual-channel, synchronous step-down converter. Both channels use peak current mode control with internal compensation for fast transient response and cycle-to-cycle current limiting.

The MPQ2169B is optimized for low-voltage, portable applications where efficiency and small size are critical.

180° Out-of-Phase Operation

The MPQ2169B operates the two channels 180° out of phase to reduce input current ripple. This allows for a smaller input bypass capacitor to be used. When both channels operate in continuous conduction mode (CCM), two internal clocks are used (see Figure 2). The high-side MOSFET (HS-FET) turns on at the clock's rising edge of the corresponding channel.

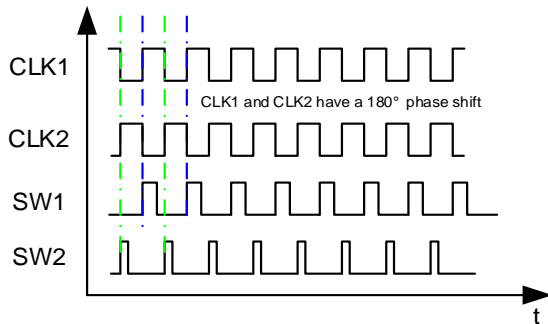

Figure 2: 180° Out-of-Phase Operation

If the switching frequency (f_{SW}) is stretched out for each channel during low-dropout mode, the MPQ2169B runs with a fixed off time and an independent f_{SW} . After the input voltage (V_{IN}) rises high again, frequency stretch mode ends. Subsequently, pulse-width modulation (PWM) mode resumes and synchronizes with the master oscillator for out-of-phase operation.

Forced Continuous Conduction Mode (FCCM)

The MPQ2169B works in forced continuous conduction mode (FCCM) with a fixed frequency from no load to full load. The advantages of FCCM are its controllable frequency and lower output ripple under light-load conditions.

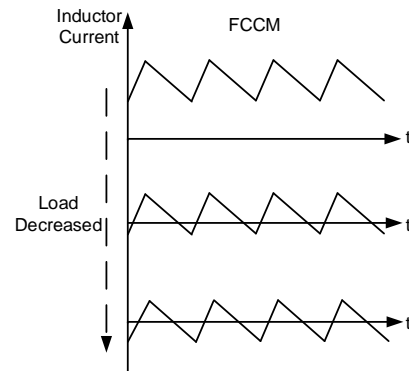

Figure 3: FCCM

Enable (EN)

EN is a digital control pin that turns the regulator on and off.

When EN is pulled below the falling threshold voltage (typically 0.8V), the chip shuts down. Pulling EN above the rising threshold voltage (typically 0.9V) turns on the part. Do not float the EN pin, since there is no internal resistor from EN to GND. If EN is floated, the part's status is uncertain, which may lead to unexpected behavior.

Soft Start (SS)

The MPQ2169B has a built-in soft start (SS) that ramps up the output voltage (V_{OUT}) at a controlled slew rate, preventing overshoot at start-up. The soft-start time (t_{SS}) is typically about 0.5ms.

t_{SS} can also be configured by an external capacitor connected to the SS pin, and can be calculated using Equation (1):

$$t_{SS}(\text{ms}) = \frac{C_{SS}(\text{nF}) \times V_{REF}(\text{V})}{I_{SS}(\mu\text{A})} \quad (1)$$

Where C_{SS} is the external SS capacitor, V_{REF} is the internal reference voltage (0.6V), and I_{SS} is the 3.2 μA SS charge current.

Oscillator and SYNC Function

The internal oscillator frequency is set by a single external resistor (R_{FREQ}) connected between FREQ and ground. The frequency-setting resistor should be placed close to the device. Figure 4 on page 19 shows the relationship between f_{SW} and R_{FREQ} .

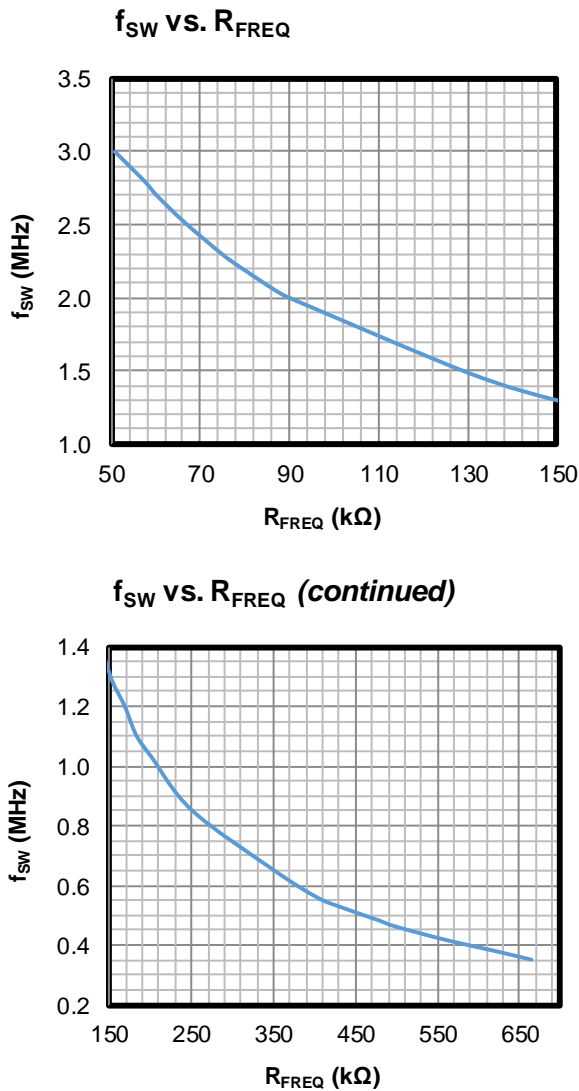

Figure 4: f_{SW} vs. R_{FREQ}

Table 1 shows the f_{SW} and R_{FREQ} values.

Table 1: f_{SW} vs. R_{FREQ}

| R _{FREQ} (kΩ) | f _{SW} (kHz) | R _{FREQ} (kΩ) | f _{SW} (kHz) |
|------------------------|-----------------------|------------------------|-----------------------|
| 665 | 350 | 90 | 2000 |
| 499 | 460 | 84.5 | 2100 |
| 200 | 1000 | 78.7 | 2200 |
| 169 | 1200 | 75 | 2300 |
| 130 | 1500 | 51 | 3000 |

The internal f_{SW} can also be synchronized to an external clock applied at the SYNC pin. The rising edge of the channel 1 clock is synchronized to the external clock's rising edge, while the channel 2 clock remains 180° out-of-phase from channel 1. The recommended external SYNC frequency range is 350kHz to

3MHz. While there is no pulse width requirement, note that there is always parasitic capacitance on the pad. If the pulse width is too short, a clear rising and falling edge may not be seen. It is recommended to make the pulse longer than 100ns.

Power Good (PG)

The MPQ2169B has one power good (PG) output to indicate normal operation after SS. PG is the open drain of an internal MOSFET. It should be connected to VIN, VCC, or an external voltage source through a resistor (e.g. 100kΩ). After V_{IN} is applied, the MOSFET turns on and PG is pulled to GND before SS is ready. After the FB voltage (V_{FB}) reaches 90% of the reference voltage (V_{REF}), the MOSFET turns off and PG is pulled high by an external voltage source. If V_{FB} drops to 82% of V_{REF}, the PG voltage is pulled to GND to indicate an output failure.

Current Limit and Short Circuit

Each channel of the MPQ2169B has a typical 4A current limit for the HS-FET. Once the inductor current (I_L) reaches the current limit, the HS-FET turns off immediately. Then the low-side MOSFET (LS-FET) turns on to discharge the energy, and I_L decreases. The HS-FET does not turn on again until I_L drops below a specified current threshold (called the valley current limit). This protection prevents I_L from running away and damaging the components.

If V_{FB} drops below 60% of V_{REF} and SS has finished, the MPQ2169B treats this as a short fault and attempts to recover with hiccup mode.

In hiccup mode, the MPQ2169B disables the output power stage, slowly discharges C_{SS}, and soft starts automatically. If the short-circuit condition still remains, the MPQ2169B repeats this operation cycle until the short circuit is removed and the output rises back to regulation levels.

Low-Side (LS) Current Limit Protection

The MPQ2169B has a -1A low-side (negative) current limit. Once I_L reaches the current limit, the LS-FET immediately turns off and the HS-FET turns on. The current limit prevents the negative current from dropping too low and possibly damaging the components.

Dropout Operation

The MPQ2169B allows the HS-FET to remain on for more than one switching cycle, and increases the duty cycle while V_{IN} drops down to V_{OUT} . When the duty cycle reaches 100%, the HS-FET turns on to deliver current to the output up to its current limit. V_{OUT} is then the

difference between V_{IN} , the voltage drop across the main switch, and the inductor.

Thermal Shutdown

The MPQ2169B employs thermal protection by internally monitoring the IC temperature, which prevents the chip from operating at exceedingly high temperatures. If the junction temperature exceeds the threshold value (typically 175°C), the whole chip shuts down. There is a 40°C hysteresis. Once the junction temperature drops to about 135°C, the device initiates a soft start and resumes normal operation. This is a non-latch protection.

APPLICATION INFORMATION

Setting the Output Voltage

The external resistor divider sets V_{OUT} . The feedback resistor (R1) also sets the feedback (FB) loop bandwidth with the internal compensation. Figure 5 shows the feedback network.

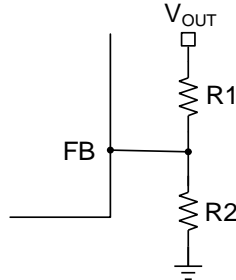

Figure 5: Feedback Network

R1 is used to set the loop bandwidth, where a lower R1 value means a higher bandwidth. However, a high bandwidth may cause an insufficient phase margin, resulting in loop instability. Therefore, a proper R1 value must make a tradeoff between the bandwidth and phase margin. Table 2 lists the recommended feedback resistor values for common output voltages.

Table 2: Resistor Selection vs. Output Voltage Setting

| V_{OUT} (V) | R1 (k Ω) | R2 (k Ω) |
|---------------|------------------|------------------|
| 1.2V | 100 | 100 |
| 1.5V | 100 | 66.5 |
| 1.8V | 100 | 49.9 |
| 2.5V | 100 | 31.6 |
| 3.3V | 100 | 22.1 |

If R1 is estimated to be 100k Ω , R2 can then be calculated using Equation (2):

$$R2 = \frac{R1}{\frac{V_{OUT}}{0.6V} - 1} \quad (2)$$

If ceramic capacitors are used as output capacitors (C_O), then the feedback loop bandwidth (f_c) should not exceed 1/10 of f_{SW} for optimal transient performance and good phase margin. If an electrolytic capacitor is used, f_c should not exceed 1/4 of the ESR zero frequency (f_{ESR}).

f_{ESR} can be calculated using Equation (3):

$$f_{ESR} = \frac{1}{2\pi \times R_{ESR} \times C_O} \quad (3)$$

For example, choose $f_c = 80\text{kHz}$ with a ceramic capacitor when $C_O = 22\mu\text{F}$.

Selecting the Inductor

An inductor with a DC current rating at least 25% above the maximum load current is recommended for most applications. For the best efficiency, the inductor DC resistance should be below 20m Ω . For most designs, the inductance can be estimated using Equation (4):

$$L = \frac{V_{OUT} \times (V_{IN} - V_{OUT})}{V_{IN} \times \Delta I_L \times f_{SW}} \quad (4)$$

Where ΔI_L is the inductor ripple current.

Choose ΔI_L to be approximately 30% of the maximum load current. The maximum inductor peak current ($I_{L(MAX)}$) can be calculated using Equation (5):

$$I_{L(MAX)} = I_{LOAD} + \frac{\Delta I_L}{2} \quad (5)$$

Selecting the Input Capacitor

The input capacitor reduces the surge current drawn from the input and the switching noise from the device. The input capacitor impedance at f_{SW} should be below the input source impedance to prevent high-frequency switching current from passing to the input source. Ceramic capacitors with X5R or X7R dielectrics are highly recommended because of their low ESR and small temperature coefficients. For most applications, a 22 μF capacitor is sufficient.

Selecting the Output Capacitor

The output capacitor (C_O) keeps the output voltage ripple small and ensures a stable regulation loop. The C_O impedance should be low at f_{SW} . It is recommended to use ceramic capacitors with X5R or X7R dielectrics. If an electrolytic capacitor is used, pay close attention to the output ripple voltage, extra heating, and the selection of the upper feedback resistor due to the large ESR of electrolytic capacitors (see the Setting the Output Voltage section).

The output voltage ripple (ΔV_{OUT}) can be estimated using Equation (6):

$$\Delta V_{OUT} = \frac{V_{OUT} \times (V_{IN} - V_{OUT})}{V_{IN} \times L \times f_{SW}} \times \left(ESR + \frac{1}{8 \times f_{SW} \times C_o} \right) \quad (6)$$

Power Dissipation

IC power dissipation is important in circuit design, not only because of efficiency concerns, but also because of the chip's thermal requirements. Several parameters influence power dissipation, such as conduction loss (P_{COND}), dead time (DT), switching loss (P_{SW}), MOSFET driver current (P_{DR}), and supply current (P_S).

Based on these parameters, the power loss (P_{LOSS}) can be calculated using Equation (7):

$$P_{LOSS} = P_{COND} + P_{DT} + P_{SW} + P_{DR} + P_S \quad (7)$$

Thermal Regulation

Changes in IC temperatures can change the electrical characteristics, especially when the temperature exceeds the IC's recommended operating range. Managing the IC's temperature requires additional considerations to ensure that the IC runs within the maximum allowable temperature junction. Specific layout designs can improve the thermal profile while limiting losses to the efficiency and/or operating range.

For the MPQ2169B, connect the ground pin on the package to a ground plane on top of the PCB, and use this plane as a heatsink. Connect this ground plane to the ground planes beneath the IC using vias to improve heat dissipation. Given that these ground planes can introduce unwanted EMI noise and occupy valuable PCB space, design their size and shape to match the thermal resistance requirement.

Connecting the ground pin to a heatsink does not guarantee that the IC remains within its recommended temperature limits (e.g. the ambient temperature may exceed the IC's temperature limits). If the ambient air temperature approaches the IC's temperature limit, the IC can be derated to operate using less power, which helps prevent thermal damage and unwanted electrical characteristics.

PCB Layout Guidelines ⁽⁹⁾

Efficient PCB layout is critical for stable operation. A 4-layer layout is strongly recommended to improve thermal performance. For the best results, refer to Figure 6 and follow the guidelines below:

1. Connect PGND1 and PGND2 together at PGND.
2. Place the high-current paths (PGND, VIN, and SW) very close to the device with short, direct, and wide traces.
3. Place input capacitors on both sides of VIN, as close to VIN and PGND as possible.
4. Place the decoupling capacitor as close to VCC and AGND as possible.
5. Keep the switching node (SW) short, and route it away from the feedback network.
6. Place the external feedback resistors next to FB.
7. Do not place vias on the FB trace.
8. Connect PGND to a large copper area to improve thermal performance.

Note:

- 9) The recommended PCB layout is based on Figure 7 on page 24.

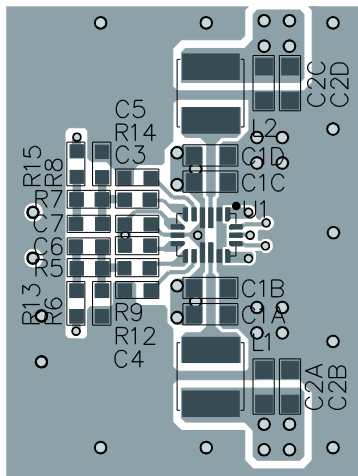

Top Layer

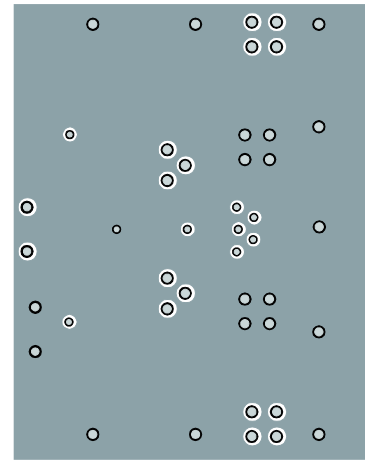

Mid-Layer 1

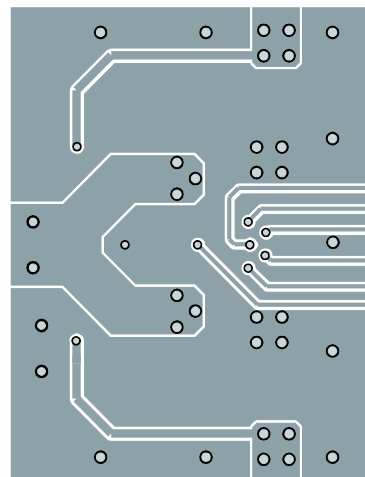

Mid-Layer 2

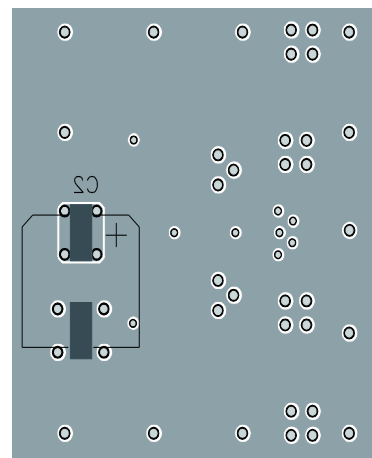

Bottom Layer

Figure 6: Recommended PCB Layout

TYPICAL APPLICATION CIRCUIT

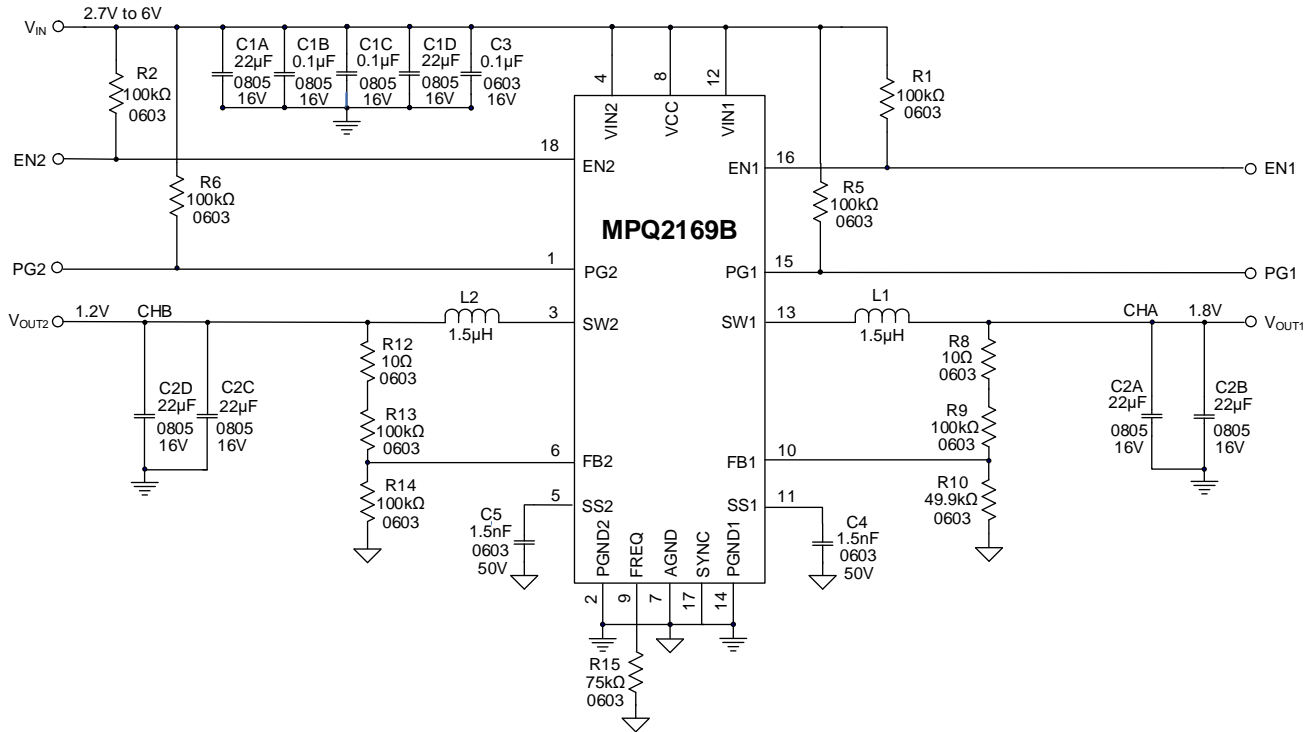
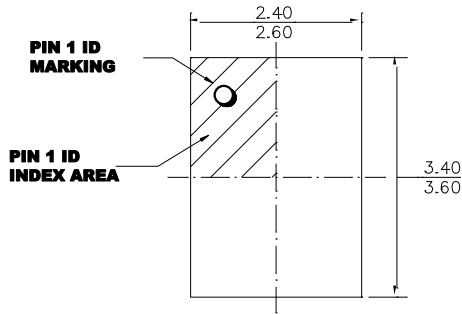

Figure 7: Typical Application Circuit

PACKAGE INFORMATION

QFN-18 (2.5mmx3.5mm)

Wettable Flank



TOP VIEW

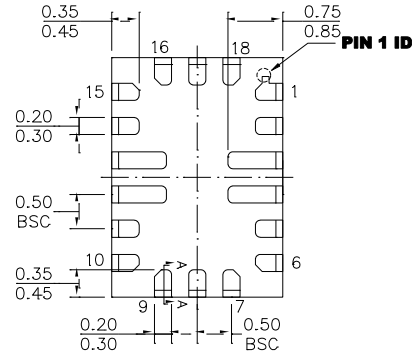

BOTTOM VIEW

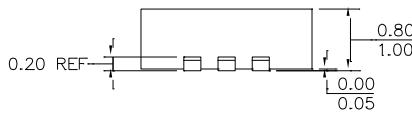

SIDE VIEW

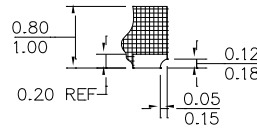

SECTION A-A

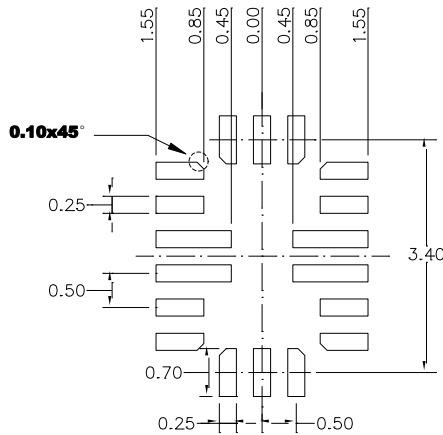

RECOMMENDED LAND PATTERN

NOTE:

- 1) THE LEAD SIDE IS WETTABLE.
- 2) LAND PATTERNS OF PIN3, 4, 12 AND 13 HAVE THE SAME LENGTH AND WIDTH.
- 3) ALL DIMENSIONS ARE IN MILLIMETERS.
- 4) LEAD COPLANARITY SHALL BE 0.08 MILLIMETERS MAX.
- 5) JEDEC REFERENCE IS MO-220.
- 6) DRAWING IS NOT TO SCALE.

CARRIER INFORMATION

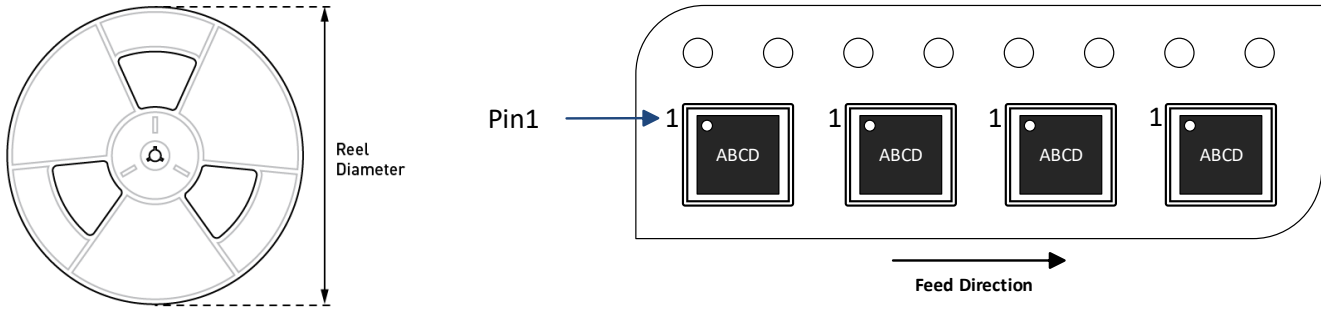

| Part Number | Package Description | Quantity /Reel | Quantity /Tube | Quantity /Tube | Reel Diameter | Carrier Tape Width | Carrier Tape Pitch |
|---------------------|----------------------|----------------|---------------------|----------------|---------------|--------------------|--------------------|
| MPQ2169BGRHE-AEC1-Z | QFN-18 (2.5mmx3.5mm) | 5000 | N/A ⁽¹⁰⁾ | N/A | 13in | 12mm | 8mm |

Note:

"N/A" indicates not available tubes. Contact MPS for 500-piece tape and reel prototype quantities. (The order code for a 500-piece partial reel is "-P." Tape and reel dimensions are the same as the full reel.)