



MPQ4425C

36V, 1.5A, 2.2MHz, High-Efficiency,
Synchronous Step-Down LED Driver,
AEC-Q100 Qualified

DESCRIPTION

The MPQ4425C is a high-frequency, synchronous, rectified, step-down, switch-mode white LED (WLED) driver with integrated internal power MOSFETs. It offers a compact solution that can achieve up to 1.5A of continuous output current (I_{OUT}) across a wide 4V to 36V input voltage (V_{IN}) range, with excellent load and line regulation.

Synchronous mode offers high efficiency across the entire I_{OUT} load range. Current mode control provides fast transient response and improved loop stabilization.

Full protection features include over-current protection (OCP) and thermal shutdown.

The MPQ4425C requires a minimal number of readily available, standard external components, and is available in a space-saving QFN-13 (2.5mmx3mm) package.

FEATURES

- Built for a Wide Range of Automotive LED Applications:
 - Wide 4V to 36V Operating Input Voltage (V_{IN}) Range
 - Up to 1.5A continuous LED current (I_{LED})
 - Pulse-Width Modulation (PWM) Dimming with Minimum 100Hz Dimming Frequency (f_{DIM})
- High Performance for Improved Thermals:
 - 90m Ω /60m Ω Low $R_{DS(ON)}$, Internal Power MOSFETs
 - 0.195V Reference Voltage (V_{REF})
 - Synchronous Mode for High-Efficiency
- Reduced EMC/EMI:
 - 2.2MHz Default Switching Frequency (f_{sw})
- Full Protection Features:
 - Fault Indication for LED Short, LED Open, and Thermal Shutdown
 - Over-Current Protection (OCP) with Valley Current Detection
 - Thermal Shutdown
- Additional Features:
 - Forced Continuous Conduction Mode (FCCM)
 - Internal Soft Start (SS)
 - CISPR25 Class 5 Compliant
 - Available in a QFN-13 (2.5mmx3mm) Package
 - Available in a Wettable Flank Package
 - Available in AEC-Q100 Grade 1

APPLICATIONS

- Fog Lights
- Daytime Running Lights (DRLs)
- Puddle Lights

All MPS parts are lead-free, halogen-free, and adhere to the RoHS directive. For MPS green status, visit the MPS website under Quality Assurance. "MPS", the MPS logo, and "Simple, Easy Solutions" are registered trademarks of Monolithic Power Systems, Inc. or its subsidiaries.

TYPICAL APPLICATION

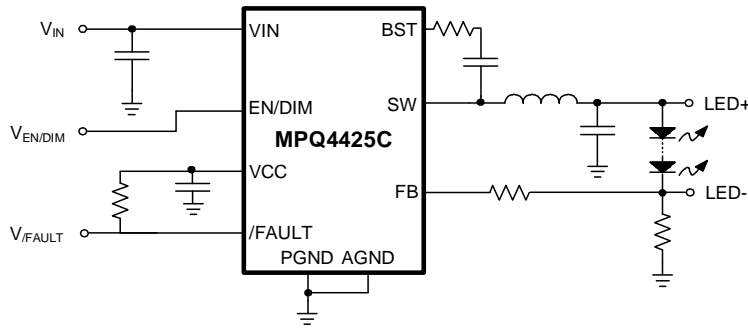

Efficiency vs. Input Voltage vs. Power Loss

2 LEDs ($V_{LED} = 6.4V$), $L = 2.2\mu H$

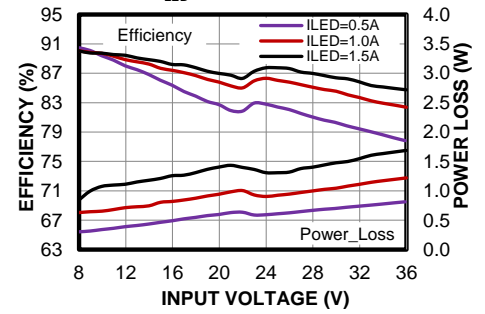

ORDERING INFORMATION

Part Number*	Package	Top Marking	MSL Rating**
MPQ4425CGQBE-AEC1***	QFN-13 (2.5mmx3mm)	See Below	Level 1

* For Tape & Reel, add suffix -Z (e.g. MPQ4425CGQBE-AEC1-Z).

** Moisture Sensitivity Level Rating

*** Wettable Flank

TOP MARKING (MPQ4425CGQBE-AEC1)

BUD
YWW
LLL

BUD: Product code of the MPQ4425CGQBE-AEC1

Y: Year code

WW: Week code

LLL: Lot number

PACKAGE REFERENCE

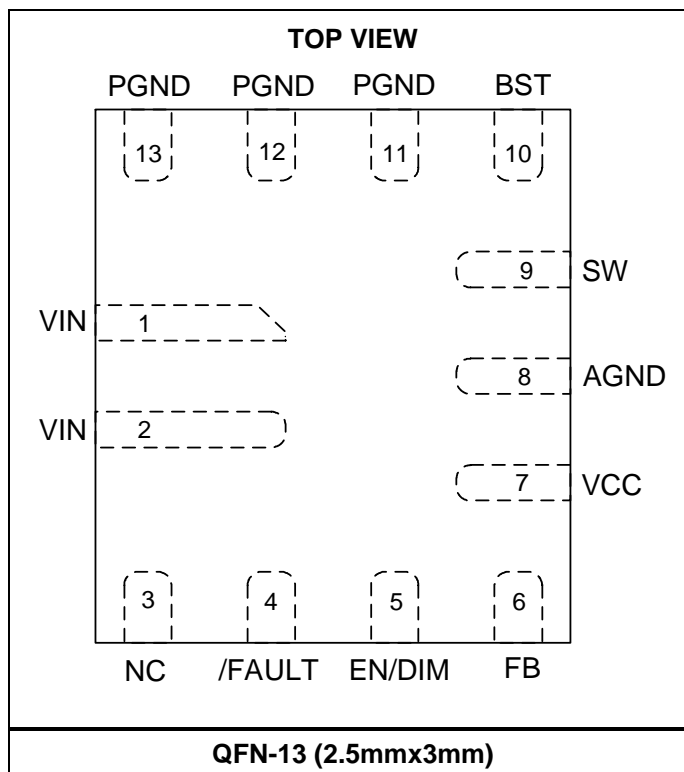

PIN FUNCTIONS

Pin #	Name	Description
1, 2	VIN	Supply voltage. The MPQ4425C operates from a 4V to 36V input rail. An input capacitor (C_{IN}) is required to decouple the input rail. Connect the VIN pin to the input trace using a wide PCB trace.
3	NC	Do not connect.
4	/FAULT	Fault indicator. The /FAULT pin is an open-drain output. If LED short, LED open, or thermal shutdown occurs, /FAULT is pulled low.
5	EN/DIM	Enable/dimming control. Pull EN above 1.8V to turn the LED driver on; pull EN below 0.7V to turn it off. Apply a 100Hz to 2kHz external clock to the EN/DIM pin for pulse-width modulation (PWM) dimming.
6	FB	LED current feedback input.
7	VCC	Internal bias supply. Decouple the VCC pin using a 0.1 μ F to 0.22 μ F capacitor. The VCC capacitor (C_{VCC}) should not exceed 0.22 μ F.
8	AGND	Analog ground. The AGND pin is the reference ground of the logic circuit. The AGND and PGND pins are connected internally. Additional external connections to PGND are not required.
9	SW	Switch output. Use a wide PCB trace to make the SW connection.
10	BST	Bootstrap. Connect a capacitor (C_{BST}) between the SW and BST pins to form a floating supply across the high-side MOSFET (HS-FET) driver. It is strongly recommended connect a 20 Ω resistor between SW and C_{BST} to reduce spikes on SW.
11, 12, 13	PGND	Power ground. The PGND pin is the reference ground of the power device. PGND requires careful consideration during PCB layout. For the best results, use copper pours and vias to make the PGND connection.

ABSOLUTE MAXIMUM RATINGS ⁽¹⁾

Input voltage (V_{IN})	-0.3V to +40V
SW voltage (V_{SW})	-0.3V to $V_{IN} + 0.3V$
BST voltage (V_{BST})	$V_{SW} + 6V$
All other pins	-0.3V to +6V ⁽²⁾
Continuous power dissipation ($T_A = 25^\circ C$) ^{(3) (8)}	
QFN-13 (2.5mmx3mm)	2.98W
Junction temperature (T_J)	150°C
Lead temperature	260°C
Storage temperature	-65°C to +150°C

Electrostatic Discharge (ESD) Rating

Human body model (HBM)	Class 2 ⁽⁴⁾
Charged device model (CDM)	Class C2b ⁽⁵⁾

Recommended Operating Conditions

Supply voltage (V_{IN})	4V to 36V
LED current (I_{LED})	Up to 1.5A
Operating T_J ⁽⁶⁾	-40°C to +125°C

Thermal Resistance	θ_{JA}	θ_{JC}
QFN-13 (2.5mmx3mm)		
JESD51-7 ⁽⁷⁾	60	13... °C/W
EVQ4425C-QB-00A ⁽⁸⁾	42	2.5.. °C/W

Notes:

- 1) Absolute maximum ratings are rated under room temperature, unless otherwise noted. Exceeding these ratings may damage the device.
- 2) See the Enable (EN) Control section on page 20 for more details.
- 3) The maximum allowable power dissipation is a function of the maximum junction temperature T_J (MAX), the junction-to-ambient thermal resistance θ_{JA} , and the ambient temperature T_A . The maximum allowable continuous power dissipation at any ambient temperature is calculated by P_D (MAX) = $(T_J$ (MAX) - T_A) / θ_{JA} . Exceeding the maximum allowable power dissipation can cause excessive die temperature, which may cause the device to go into thermal shutdown. Internal thermal shutdown circuitry protects the device from permanent damage.
- 4) Per AEC-Q100-002.
- 5) Per AEC-Q100-011.
- 6) Operating devices at >125°C junction temperatures is possible. Contact MPS for details.
- 7) Measured on JESD51-7, 4-layer PCB. The value of θ_{JA} given in this table is only valid for comparison with other packages and cannot be used for design purposes. These values were calculated in accordance with JESD51-7 and simulated on a specified JEDEC board. They do not represent the performance obtained in an actual application.
- 8) Measured on the EVQ4425C-QB-00A (6.4cmx6.4cm), 2oz copper thick, 4-layer PCB.

ELECTRICAL CHARACTERISTICS

$V_{IN} = 12V$, $V_{EN} = 2V$, $T_J = -40^{\circ}C$ to $+125^{\circ}C$, typical values are at $T_J = 25^{\circ}C$, unless otherwise noted.

Parameter	Symbol	Condition	Min	Typ	Max	Units
Shutdown current	I_{IN}	$V_{EN} = 0V$		12		μA
Quiescent current	I_Q	$V_{EN} = 2V$, $V_{FB} = 1V$, no switching		0.6	0.8	mA
High-side MOSFET (HS-FET) on resistance	$R_{DS(ON)_{HS}}$	$V_{BST} - V_{SW} = 5V$		90	160	m Ω
Low-side MOSFET (LS-FET) on resistance	$R_{DS(ON)_{LS}}$	$V_{CC} = 5V$		60	115	m Ω
Switch leakage	I_{SW_LKG}	$V_{EN} = 0V$, $V_{SW} = 12V$			1	μA
Current limit ⁽⁹⁾	I_{LIMIT}	<40% duty cycle	2.5	4	5.5	A
Reverse current limit				1.2		A
Switching frequency	f_{SW}	$V_{FB} = 100mV$	1800	2200	2600	kHz
Maximum duty cycle	D_{MAX}	$V_{FB} = 100mV$	80	87		%
Minimum on time ⁽⁹⁾	t_{ON_MIN}			46		ns
Feedback voltage	V_{FB}	$T_J = 25^{\circ}C$	187	195	203	mV
		$T_J = -40^{\circ}C$ to $+125^{\circ}C$	180	195	210	
Feedback current	I_{FB}	$V_{FB} = 250mV$		30	200	nA
EN rising threshold	V_{EN_RISING}		1.1	1.45	1.8	V
EN falling threshold	$V_{EN_FALLING}$		0.7	1	1.3	V
EN hysteresis	V_{EN_HYS}			450		mV
EN current	I_{EN}	$V_{EN} = 2V$		5	10	μA
		$V_{EN} = 0$		0	0.2	μA
EN turn-off delay	$t_{EN_OFF_DELAY}$		10	25	50	ms
V_{IN} under-voltage lockout (UVLO) rising threshold	$V_{IN_UVLO_RISING}$		3.2	3.5	3.8	V
V_{IN} UVLO falling threshold	$V_{IN_UVLO_FALLING}$		2.8	3.1	3.5	V
V_{IN} UVLO hysteresis	$V_{IN_UVLO_HYS}$			400		mV
Over-voltage (OV) detection	V_{OV_DET}	/FAULT is pulled low		140		% of V_{FB}
OV detection hysteresis	$V_{OV_DET_HYS}$			20		% of V_{FB}
/FAULT delay	$t_{/FAULT}$			10		μs
/FAULT sink current capability	$V_{/FAULT}$	Sink 4mA			0.4	V
/FAULT leakage current	$I_{/FAULT_LKG}$				100	nA
VCC regulator voltage	V_{CC}	$I_{CC} = 0mA$	4.6	4.9	5.2	V
VCC load regulation		$I_{CC} = 5mA$		1.5	4	%
Soft-start time ⁽⁹⁾	t_{SS}	$I_{LED} = 1.5A$, $L = 2.2\mu H$, 2-series LED load I_{LED} from 10% to 90%		1		ms
Thermal shutdown ⁽⁹⁾			150	170		$^{\circ}C$
Thermal hysteresis ⁽⁹⁾				30		$^{\circ}C$

Note:

9) Guaranteed by design and characterization. Not tested in production.

TYPICAL CHARACTERISTICS

$V_{IN} = 12V$, $T_J = -40^{\circ}C$ to $+125^{\circ}C$, unless otherwise noted.

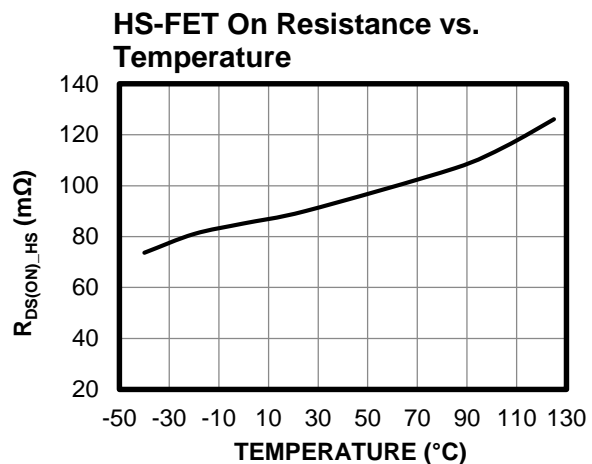
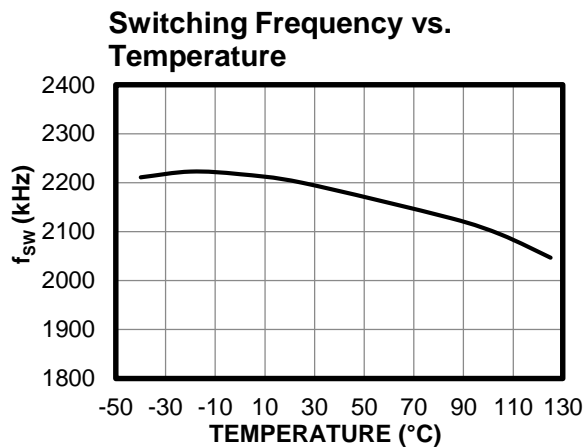
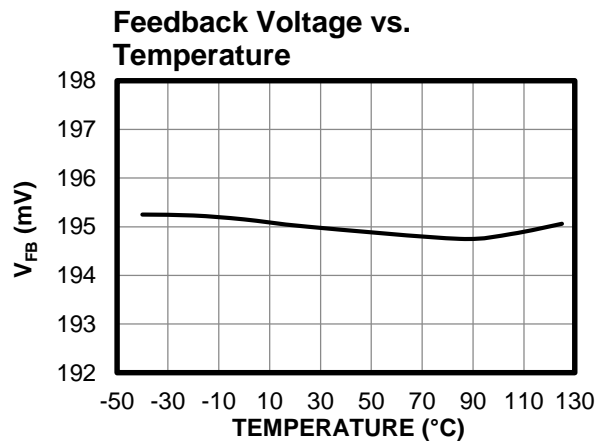
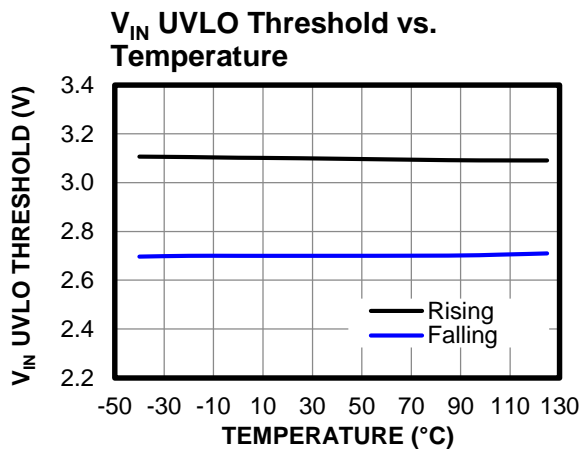
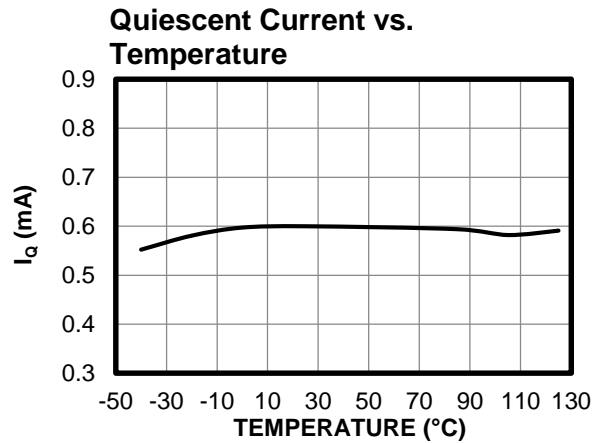
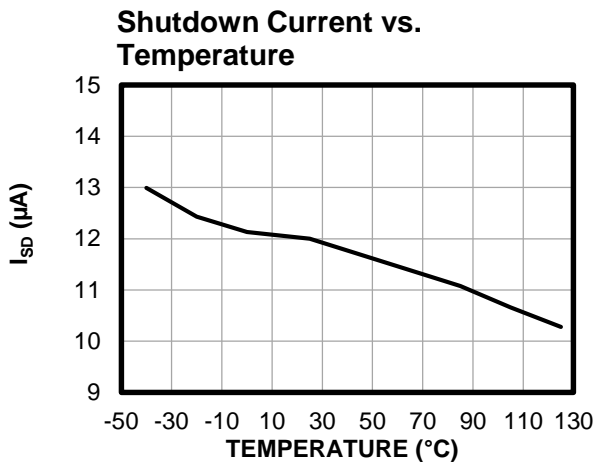

TYPICAL CHARACTERISTICS (continued)
 $V_{IN} = 12V$, $T_J = -40^{\circ}C$ to $+125^{\circ}C$, unless otherwise noted.

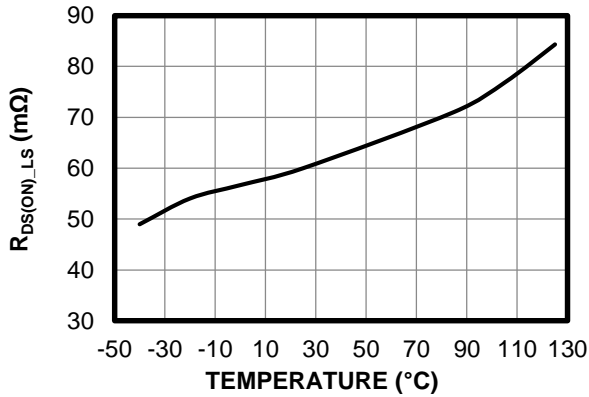
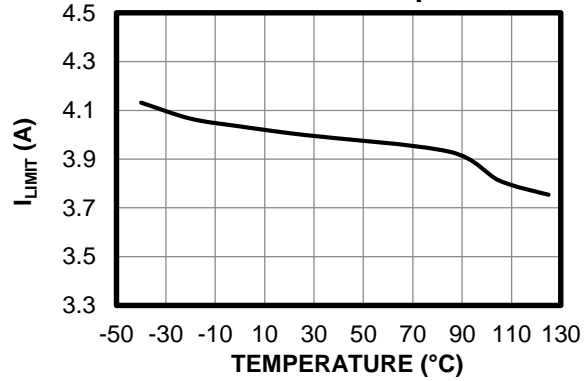
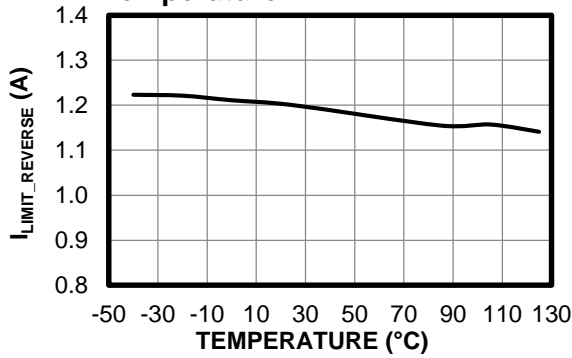
LS-FET On Resistance vs. Temperature

Current Limit vs. Temperature

Reverse Current Limit vs. Temperature

TYPICAL PERFORMANCE CHARACTERISTICS

$V_{IN} = 12V$, $V_{LED+} - V_{LED-} = 2 \times 3.2V$ at $I_{LED} = 1.5A$, $L = 2.2\mu H$, $f_{sw} = 2.2MHz$, $T_A = 25^\circ C$, unless otherwise noted. ⁽¹⁰⁾

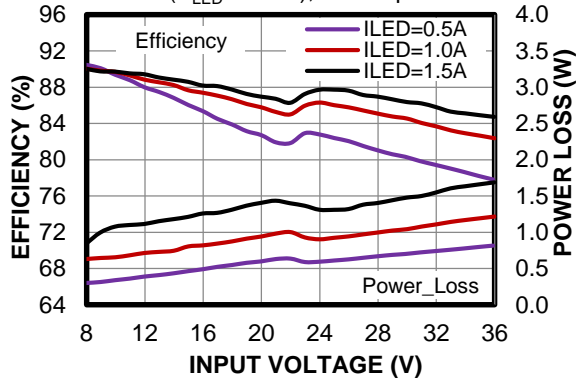
Efficiency vs. Input Voltage vs. Power Loss

2 LEDs ($V_{LED} = 6.4V$), $L = 2.2\mu H$



Efficiency vs. Input Voltage vs. Power Loss

1 LED ($V_{LED} = 3.2V$), $L = 2.2\mu H$

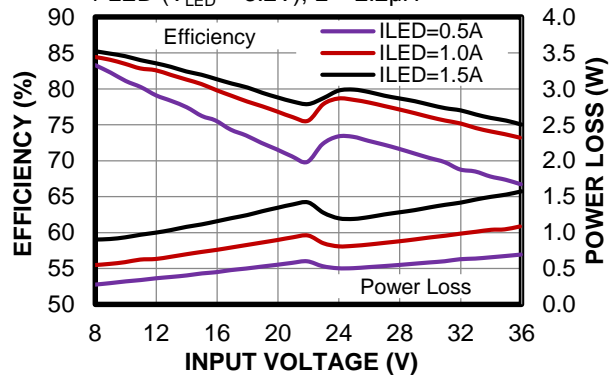

Case Temperature Rise

2 LEDs ($V_{LED} = 6.4V$)

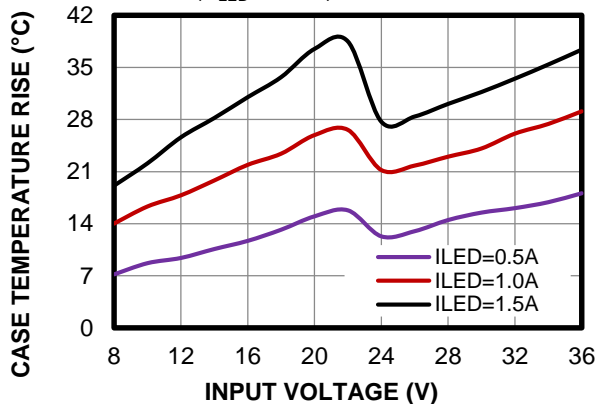

Case Temperature Rise

1 LED ($V_{LED} = 3.2V$)

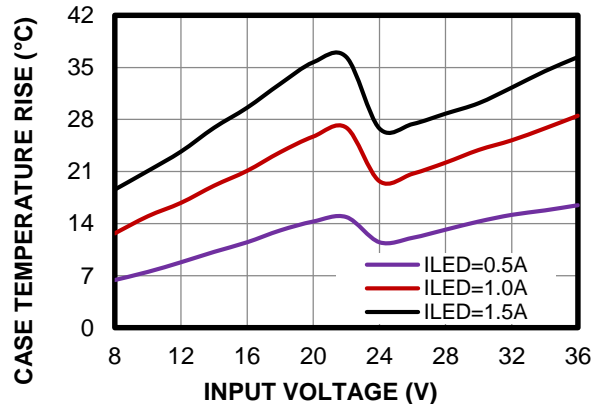

Switching Frequency vs. Input Voltage

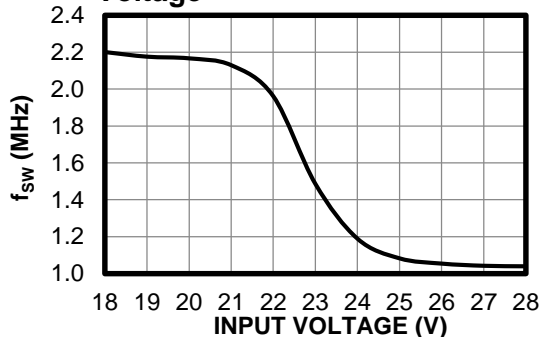

Note:

10) The Efficiency and Case Temperature Rise curves are based on Figure 9 on page 26, where the bootstrap (BST) resistor (R_{BST}) is 0Ω , the output and input filters have been removed, and the inductor (L) is $2.2\mu H$ (VCTA25201B-2R2MS6).

TYPICAL PERFORMANCE CHARACTERISTICS *(continued)*

$V_{IN} = 12V$, $V_{LED+} - V_{LED-} = 2 \times 3.2V$ at $I_{LED} = 1.5A$, $L = 2.2\mu H$, $f_{SW} = 2.2MHz$, with EMI filters, $T_A = 25^\circ C$, unless otherwise noted. ⁽¹¹⁾

CISPR25 Class 5 Peak Conducted Emissions

150kHz to 108MHz

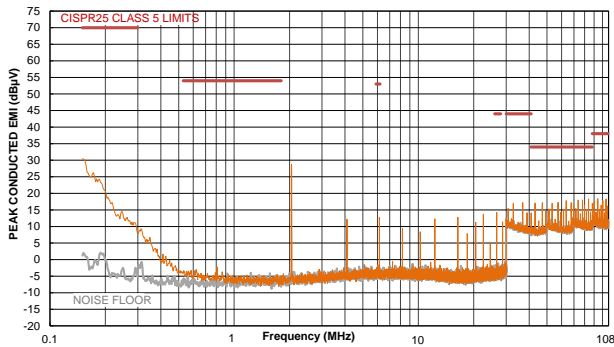

CISPR25 Class 5 Average Conducted Emissions

150kHz to 108MHz

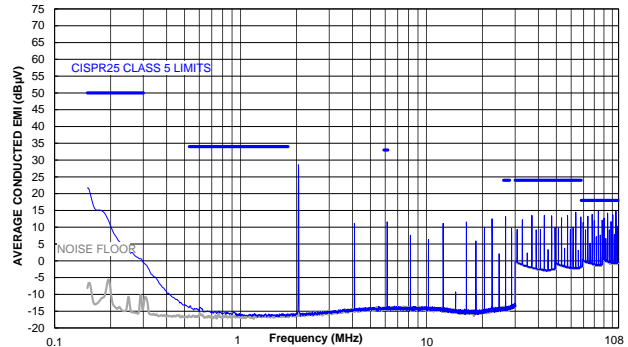

CISPR25 Class 5 Peak Radiated Emissions

150kHz to 30MHz

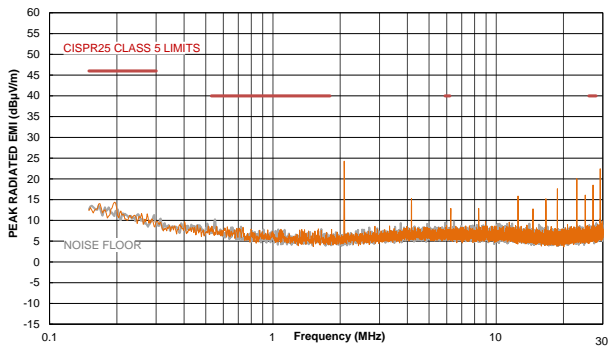

CISPR25 Class 5 Average Radiated Emissions

150kHz to 30MHz

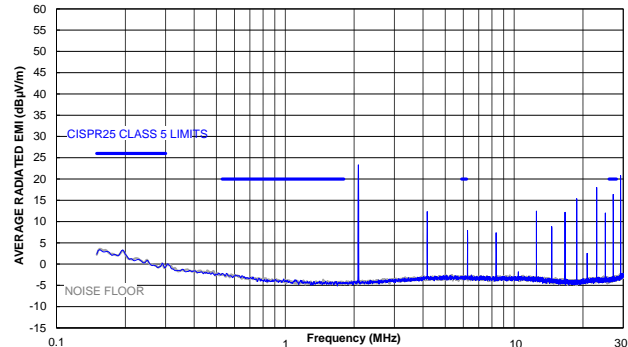

CISPR25 Class 5 Peak Radiated Emissions

Horizontal, 30MHz to 200MHz

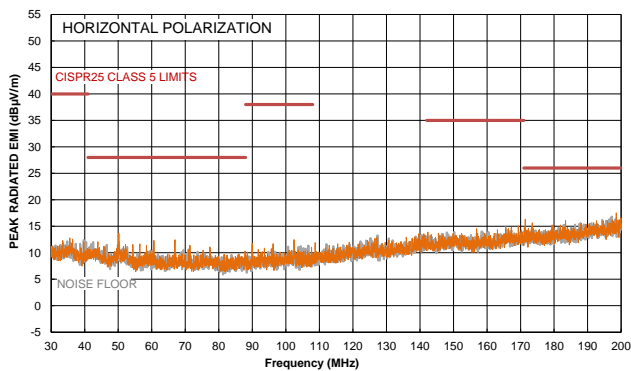

CISPR25 Class 5 Average Radiated Emissions

Horizontal, 30MHz to 200MHz

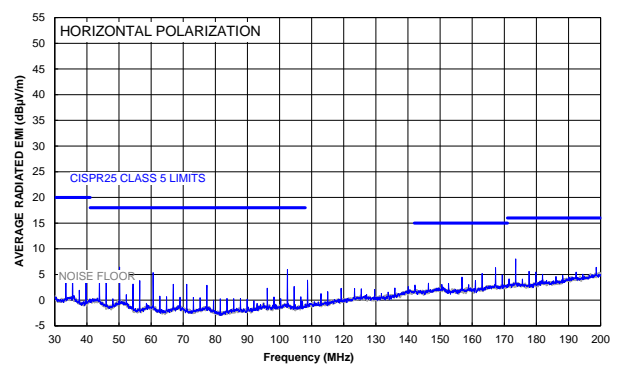

TYPICAL PERFORMANCE CHARACTERISTICS *(continued)*

$V_{IN} = 12V$, $V_{LED+} - V_{LED-} = 2 \times 3.2V$ at $I_{LED} = 1.5A$, $L = 2.2\mu H$, $f_{SW} = 2.2MHz$, with EMI filters, $T_A = 25^\circ C$, unless otherwise noted. ⁽¹¹⁾

CISPR25 Class 5 Peak Radiated Emissions

Vertical, 30MHz to 200MHz

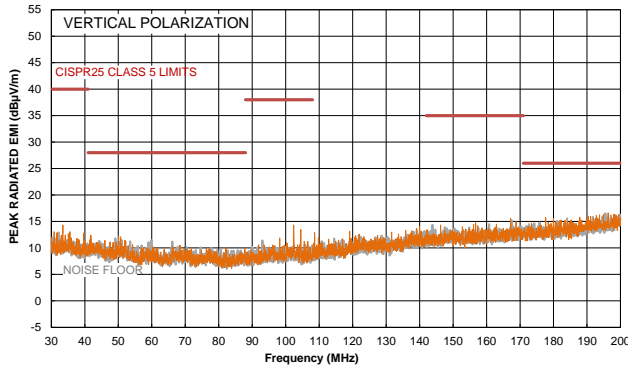

CISPR25 Class 5 Average Radiated Emissions

Vertical, 30MHz to 200MHz

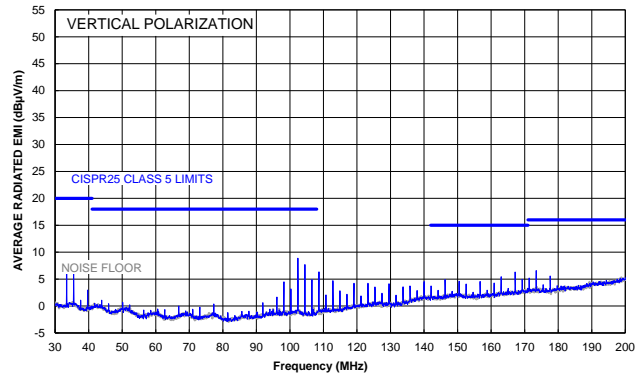

CISPR25 Class 5 Peak Radiated Emissions

Horizontal, 200MHz to 1GHz

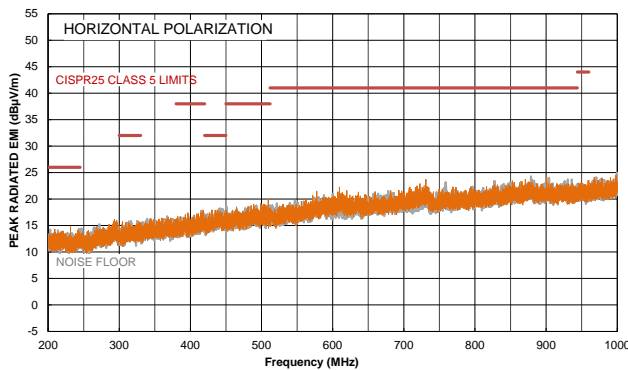

CISPR25 Class 5 Average Radiated Emissions

Horizontal, 200MHz to 1GHz

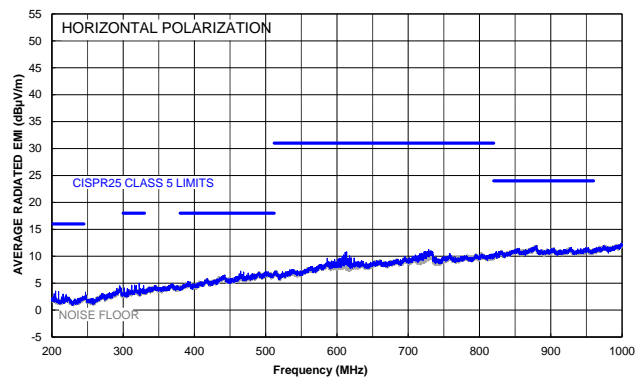

CISPR25 Class 5 Peak Radiated Emissions

Vertical, 200MHz to 1GHz

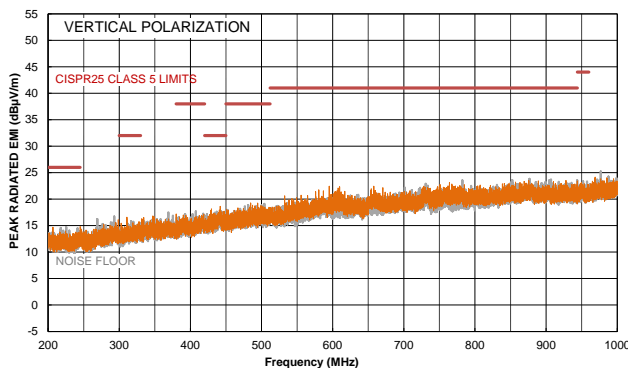

CISPR25 Class 5 Average Radiated Emissions

Vertical, 200MHz to 1GHz

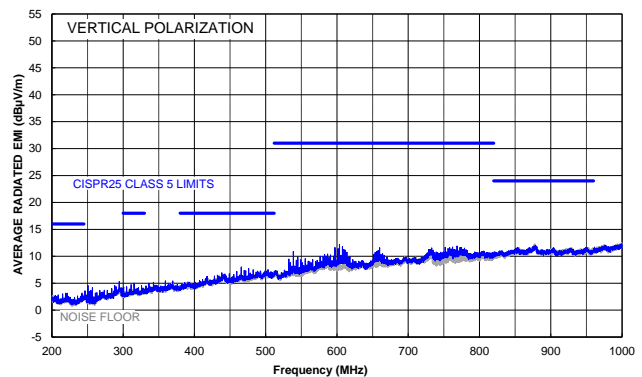

Note:

11) The EMI test results are based on Figure 10 on page 26.

TYPICAL PERFORMANCE CHARACTERISTICS (continued)
 $V_{IN} = 12V$, $V_{LED+} - V_{LED-} = 2 \times 3.2V$ at $I_{LED} = 1.5A$, $L = 2.2\mu H$, $f_{SW} = 2.2MHz$, $T_A = 25^\circ C$, unless otherwise noted.

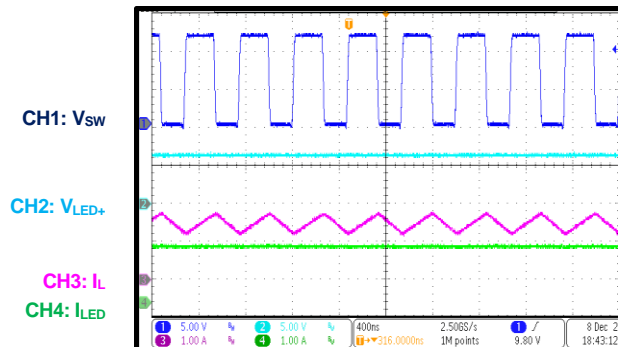
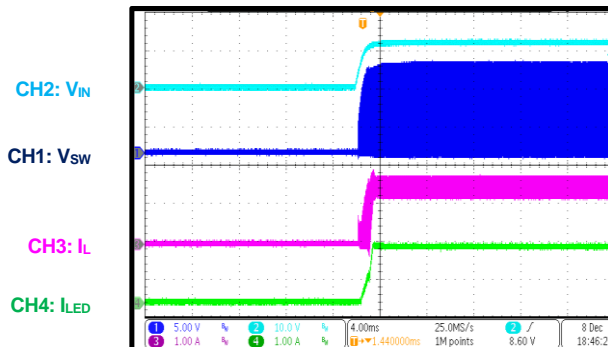
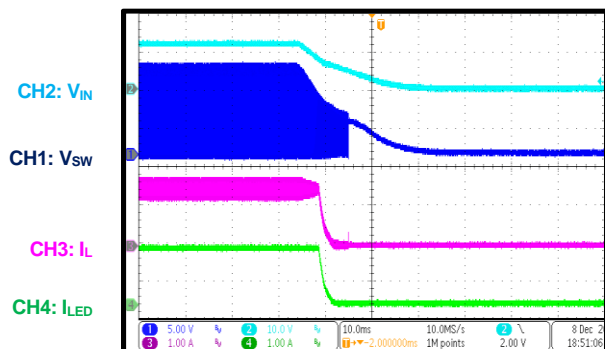
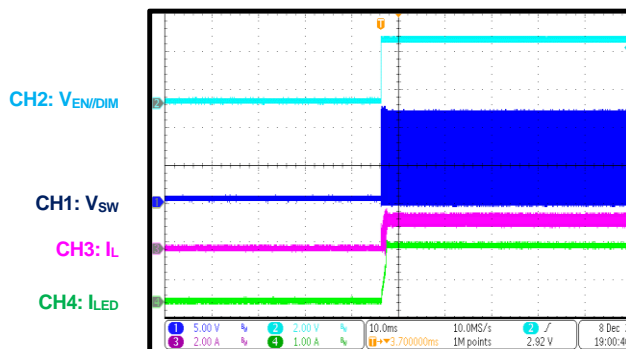
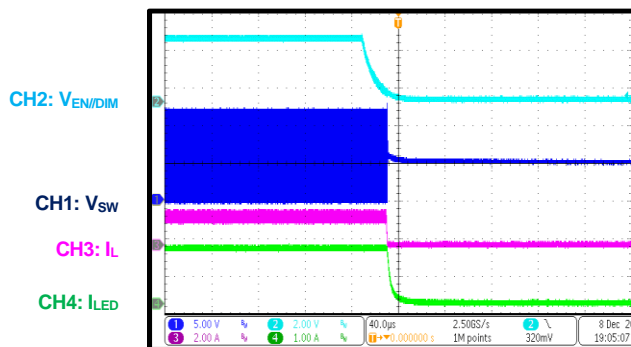
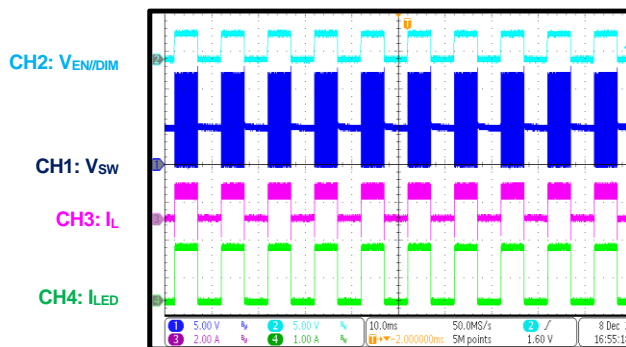
Steady State
 $I_{LED} = 1.5A$

Start-Up through VIN
 $I_{LED} = 1.5A$

Shutdown through VIN
 $I_{LED} = 1.5A$

Start-Up through EN
 $I_{LED} = 1.5A$

Shutdown through EN
 $I_{LED} = 1.5A$

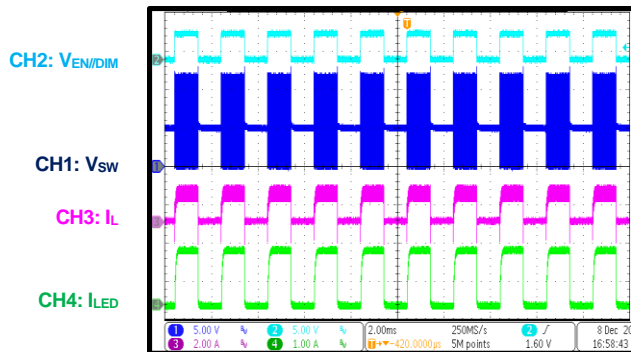
PWM Dimming Steady State
 $f_{DIM} = 100Hz$

TYPICAL PERFORMANCE CHARACTERISTICS *(continued)*

$V_{IN} = 12V$, $V_{LED+} - V_{LED-} = 2 \times 3.2V$ at $I_{LED} = 1.5A$, $L = 2.2\mu H$, $f_{SW} = 2.2MHz$, $T_A = 25^\circ C$, unless otherwise noted.

PWM Dimming Steady State

$f_{DIM} = 500Hz$



PWM Dimming Steady State

$f_{DIM} = 2kHz$

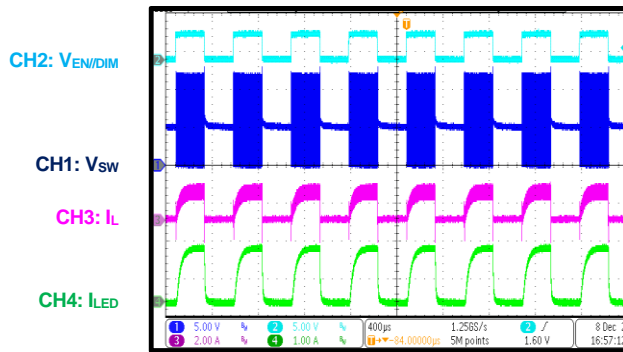

PWM Dimming

Start-up through VIN

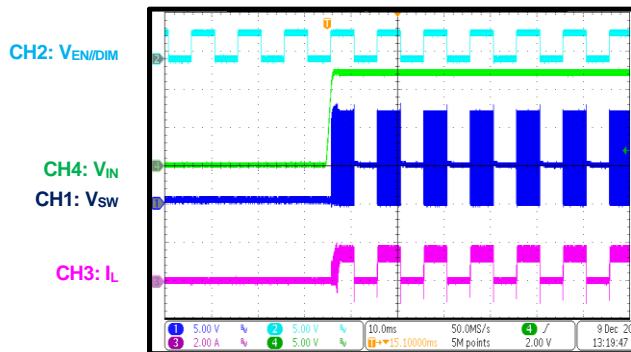

PWM Dimming

Shutdown through VIN

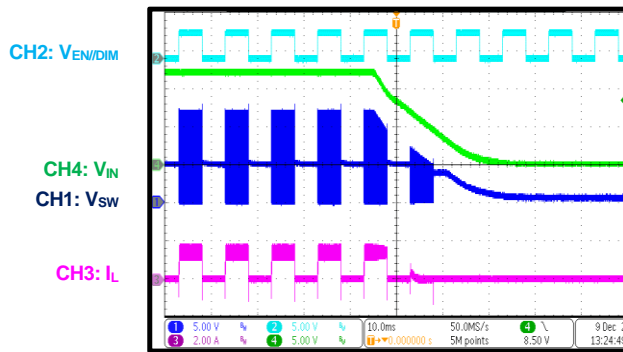

LED Open Steady State

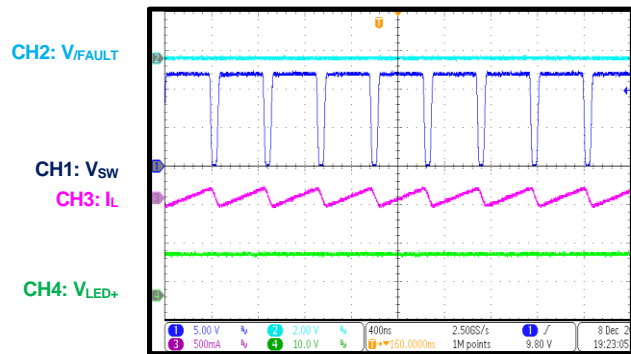

LED Open Start-Up through VIN

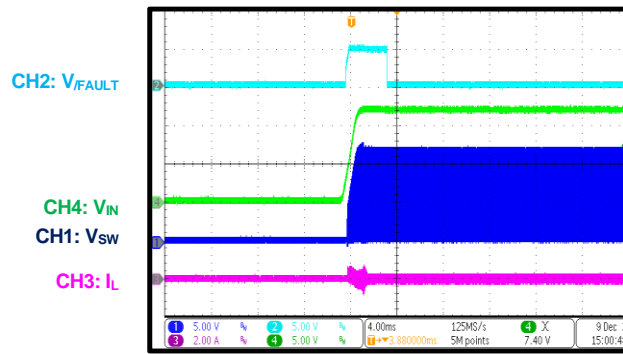

TYPICAL PERFORMANCE CHARACTERISTICS (continued)
 $V_{IN} = 12V$, $V_{LED+} - V_{LED-} = 2 \times 3.2V$ at $I_{LED} = 1.5A$, $L = 2.2\mu H$, $f_{SW} = 2.2MHz$, $T_A = 25^\circ C$, unless otherwise noted.

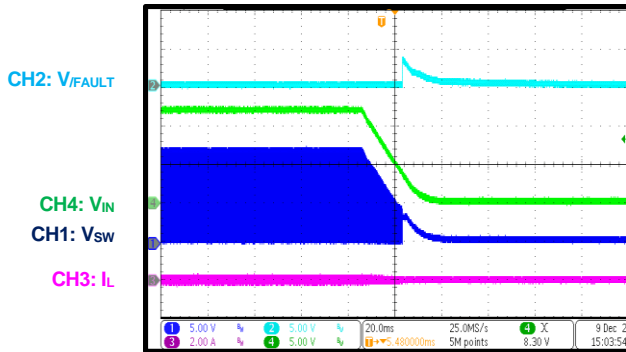
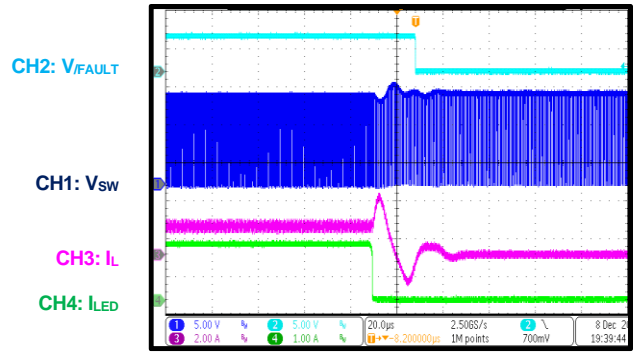
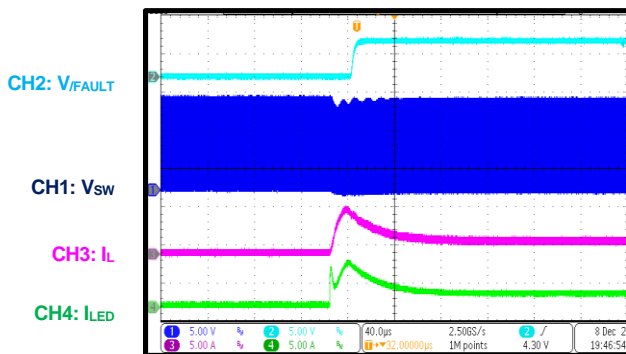
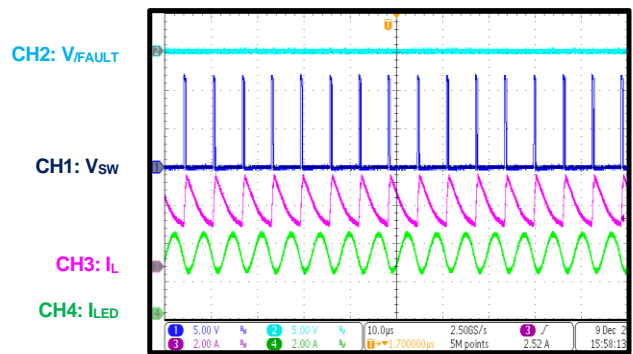
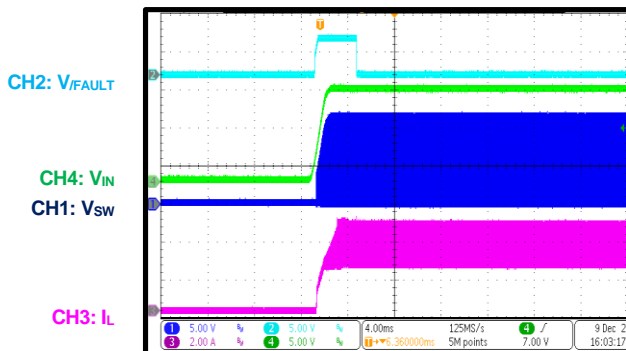
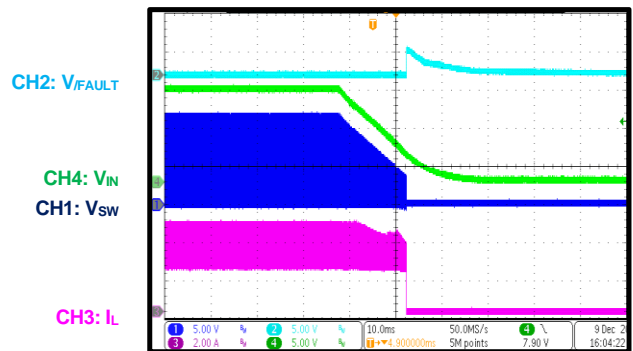
LED Open Shutdown through VIN

LED Open Entry

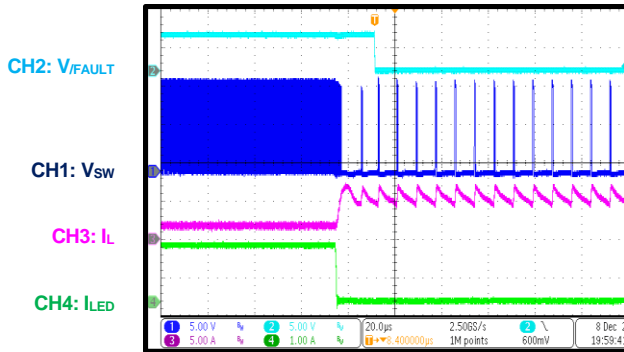
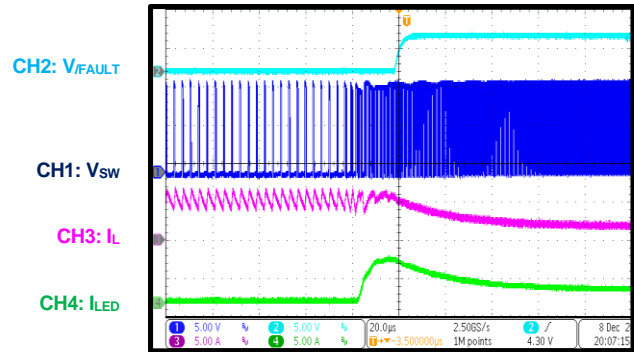
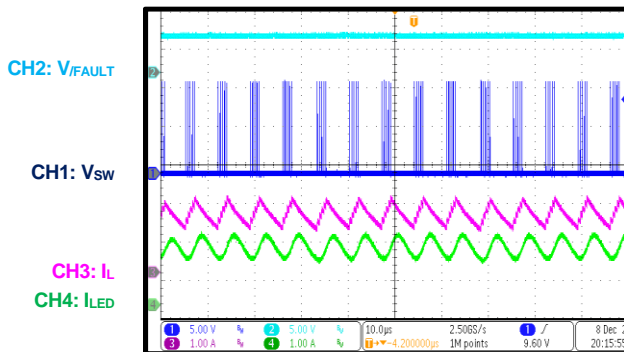
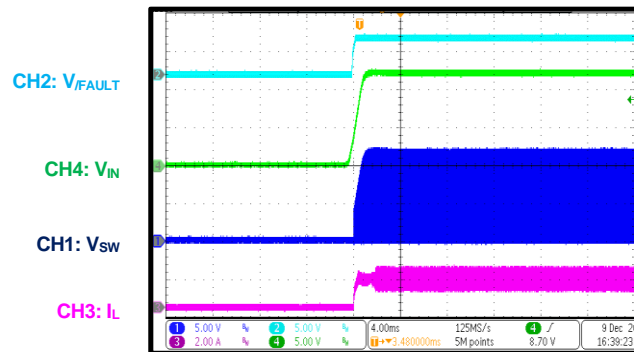
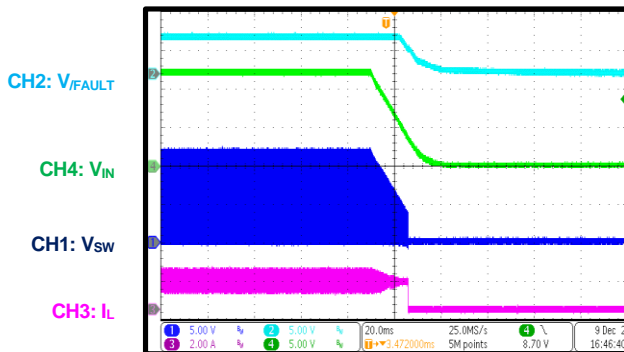
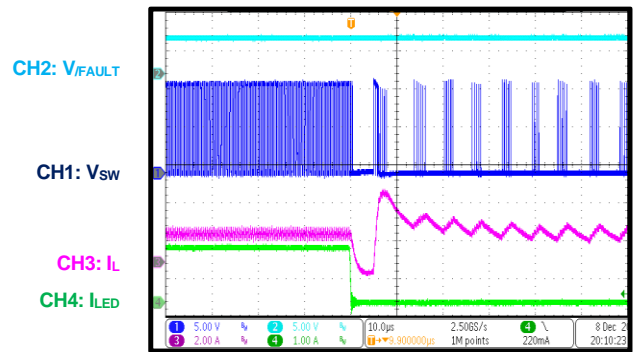
LED Open Recovery

LED+ Short to Ground Steady State

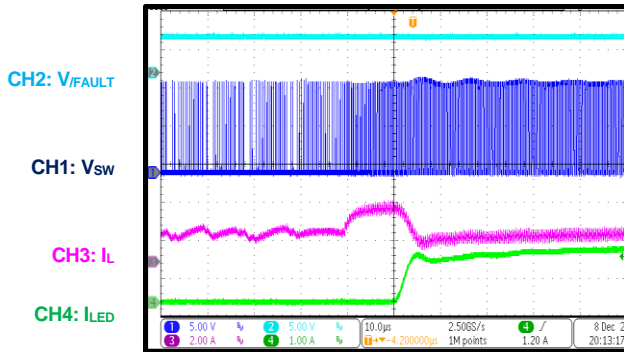
LED+ Short to Ground Start-Up through VIN

LED+ Short to Ground Shutdown through VIN

TYPICAL PERFORMANCE CHARACTERISTICS (continued)
 $V_{IN} = 12V$, $V_{LED+} - V_{LED-} = 2 \times 3.2V$ at $I_{LED} = 1.5A$, $L = 2.2\mu H$, $f_{SW} = 2.2MHz$, $T_A = 25^\circ C$, unless otherwise noted.

LED+ Short to Ground Entry

LED+ Short to Ground Recovery

LED+ Short to LED- Steady State

LED+ Short to LED- Start-Up through VIN

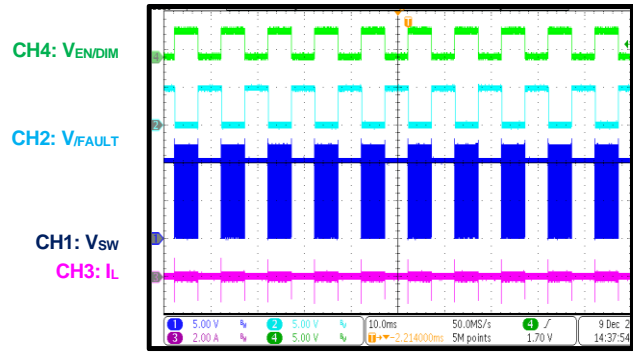
LED+ Short to LED- Shutdown through VIN

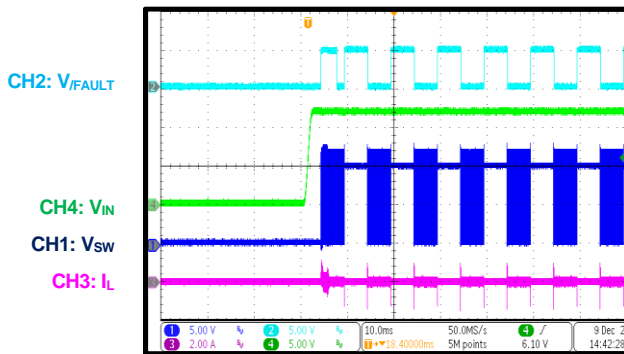
LED+ Short to LED- Entry

TYPICAL PERFORMANCE CHARACTERISTICS (continued)
 $V_{IN} = 12V$, $V_{LED+} - V_{LED-} = 2 \times 3.2V$ at $I_{LED} = 1.5A$, $L = 2.2\mu H$, $f_{SW} = 2.2MHz$, $T_A = 25^\circ C$, unless otherwise noted.

LED+ Short to LED- Recovery

PWM Dimming

LED open steady state

PWM Dimming

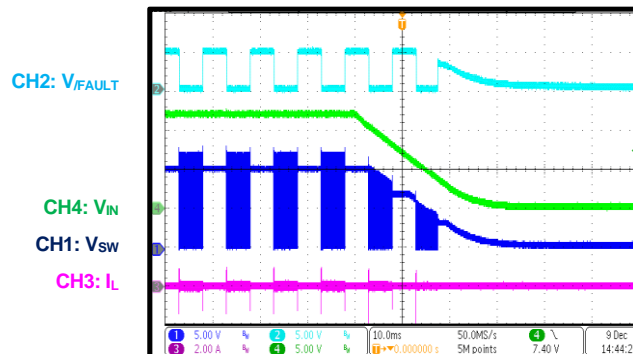
 LED open start-up through V_{IN}

PWM Dimming

 LED open shutdown through V_{IN}

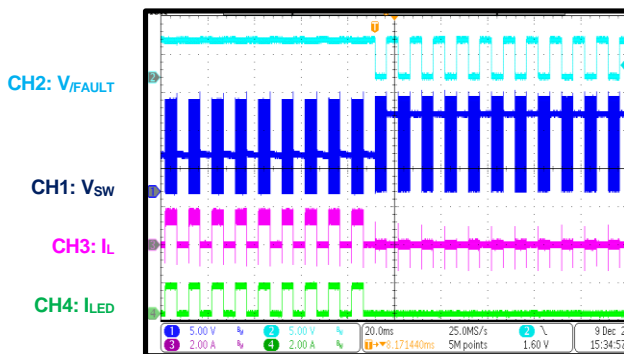
PWM Dimming

LED open entry

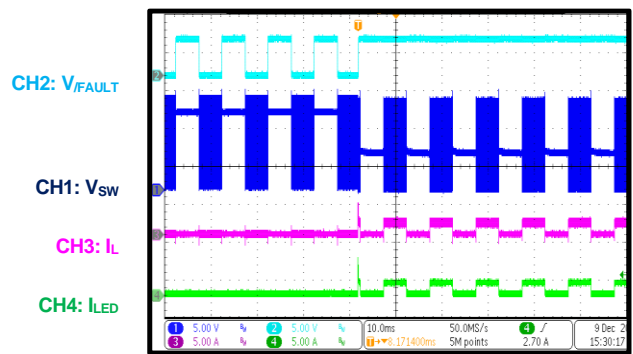
PWM Dimming

LED open recovery



TYPICAL PERFORMANCE CHARACTERISTICS (continued)
 $V_{IN} = 12V, V_{LED+} - V_{LED-} = 2 \times 3.2V @ I_{LED} = 1.5A, L = 2.2\mu H, f_{SW} = 2.2MHz, T_A = 25^\circ C$, unless otherwise noted.

PWM Dimming

LED+ short to ground steady state

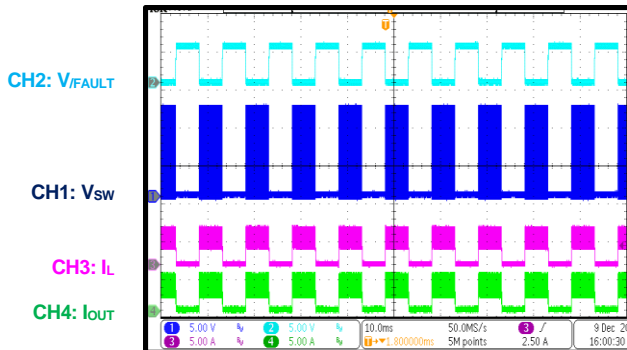

PWM Dimming

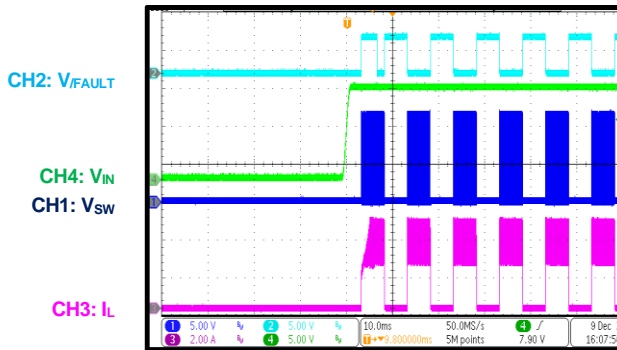
LED+ short to ground start-up through VIN

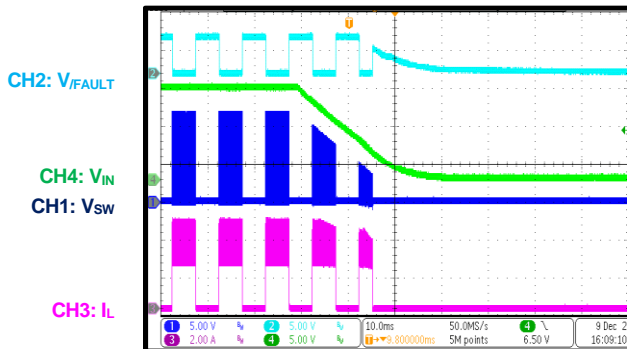

PWM Dimming

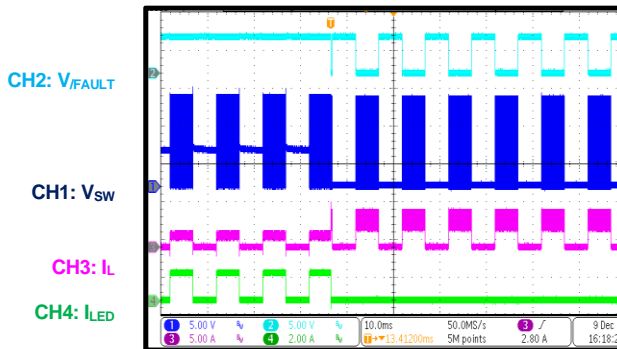
LED+ short to ground shutdown through VIN

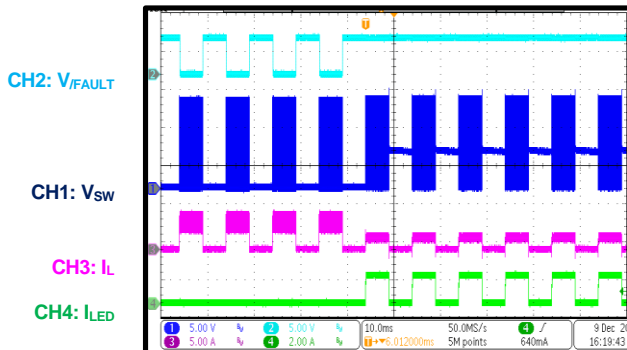

PWM Dimming

 LED+ short to ground entry, I_{PEAK} = 3A

PWM Dimming

LED+ short to ground recovery

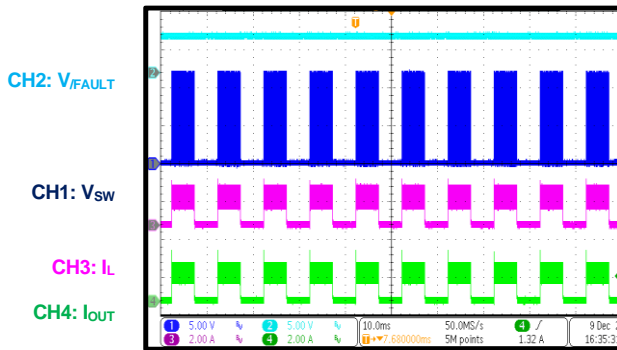
PWM Dimming

LED+ short to LED- steady state



TYPICAL PERFORMANCE CHARACTERISTICS (continued)
 $V_{IN} = 12V$, $V_{LED+} - V_{LED-} = 2 \times 3.2V$ @ $I_{LED} = 1.5A$, $L = 2.2\mu H$, $f_{SW} = 2.2MHz$, $T_A = 25^\circ C$, unless otherwise noted.

PWM Dimming

LED+ Short to LED- Input Power-On

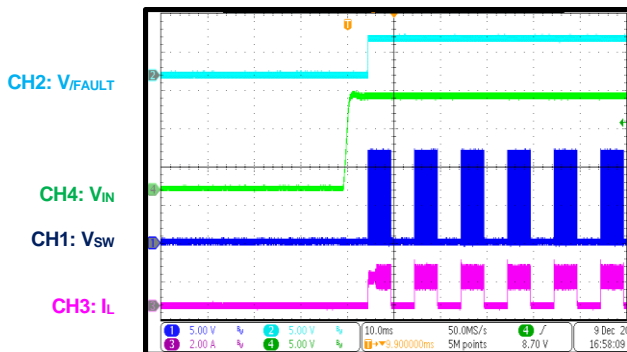
PWM Dimming

LED+ Short to LED- Input Power-Off

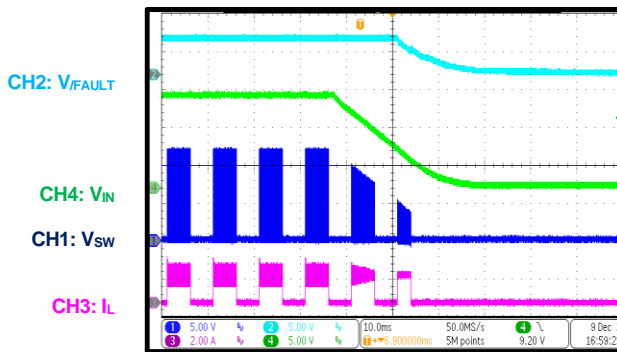
PWM Dimming

LED+ Short to LED- Entry

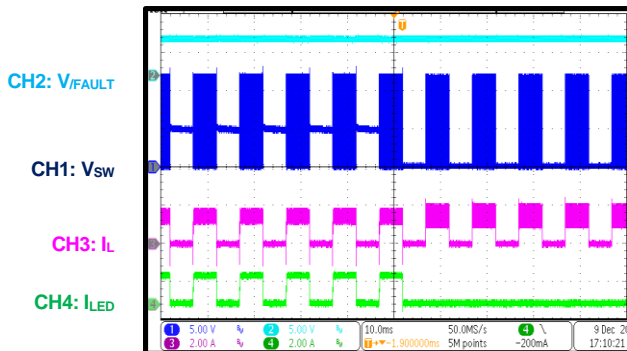
PWM Dimming

LED+ Short to LED- Recovery

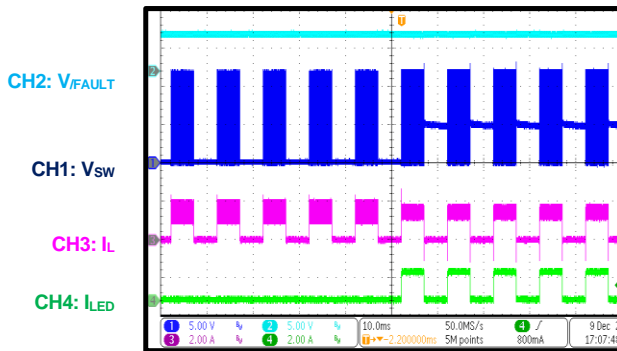

FUNCTIONAL BLOCK DIAGRAM

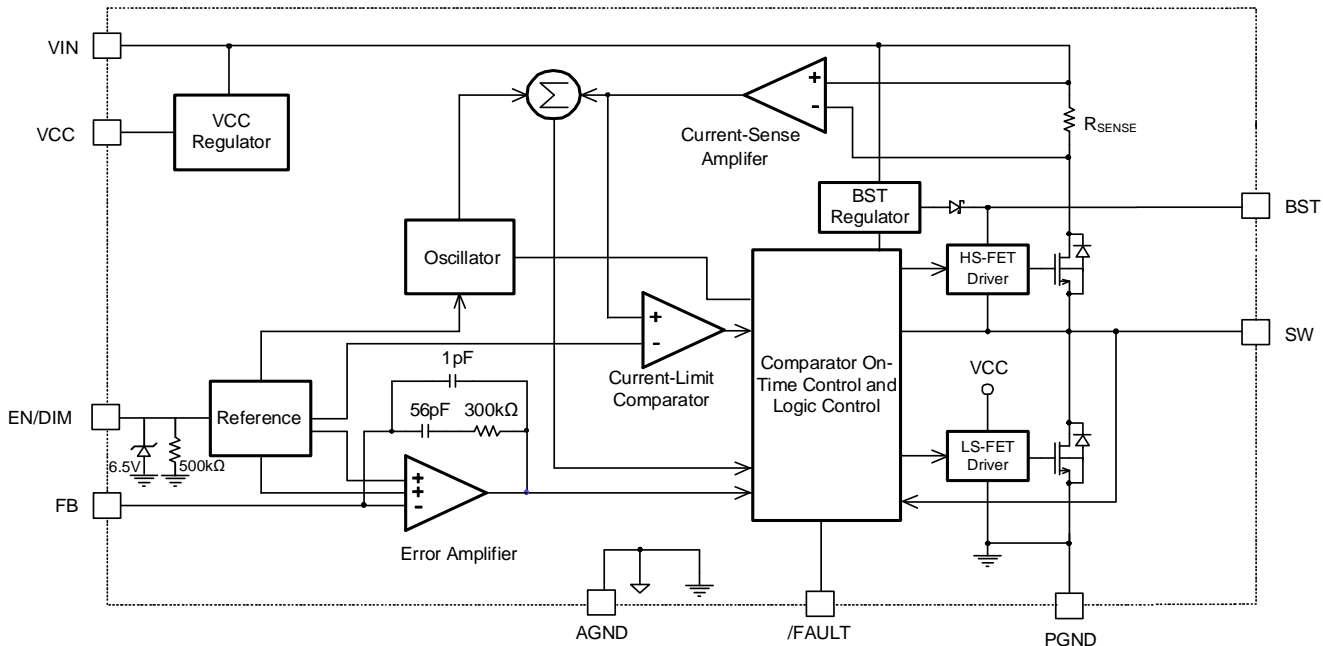

Figure 1: Functional Block Diagram

OPERATION

The MPQ4425C is a high-frequency, synchronous, rectified, step-down, switch-mode white LED (WLED) driver with integrated internal power MOSFETs. It offers a compact solution that can achieve up to 1.5A of continuous output current (I_{OUT}) across a wide 4V to 36V input voltage (V_{IN}) range, with excellent load and line regulation.

The MPQ4425C operates with a fixed-frequency in peak current control mode to regulate I_{OUT} . A pulse-width modulation (PWM) cycle is initiated by the internal clock. At the rising edge of the clock, the high-side power MOSFET (HS-FET) turns on and remains on until its current reaches the value set by the internal comparator voltage (V_{COMP}). The HS-FET remains off until the next clock cycle begins.

If I_{HS} does not reach the V_{COMP} value within 87% of one PWM cycle, the HS-FET turns off.

Internal Regulator (VCC)

The 4.9V internal VCC regulator powers most of the internal circuitry. This regulator uses the V_{IN} pin as its input and operates across the entire V_{IN} range. If V_{IN} exceeds 4.9V, then VCC is in full regulation. If V_{IN} drops below 4.9V, then the output decreases with V_{IN} . Decouple VCC using a 0.1 μ F ceramic decoupling capacitor.

Forced Continuous Conduction Mode (FCCM)

The MPQ4425C employs forced continuous conduction mode (FCCM) to ensure that the part operates with a fixed frequency at no loads to full loads. The advantage of FCCM is the controllable frequency and lower output voltage ripple (ΔV_{OUT}) at light loads.

Frequency Foldback

The MPQ4425C enters frequency foldback once V_{IN} exceeds 21V. The frequency decreases to half its nominal value (1.1MHz).

Frequency foldback also occurs during soft start (SS) and short-circuit protection (SCP).

Error Amplifier (EA)

The error amplifier (EA) compares the feedback (FB) voltage (V_{FB}) to the internal reference (V_{REF}) (0.195V), and outputs a current proportional to the difference between the two. This current

charges or discharges the internal compensation network to form V_{COMP} , which controls I_{HS} . The optimized internal compensation network minimizes the external component count and simplifies control loop design.

Enable (EN) Control

EN/DIM is a control pin that enables and disabled the WLED driver. Pull EN/DIM high to turn the WLED driver on; pull EN/DIM low for 25ms or float EN/DIM to turn it off. An internal 500k Ω resistor connected between EN/DIM and ground allows EN/DIM to be floated.

EN/DIM is clamped internally via a 6.5V series Zener diode (see Figure 2).

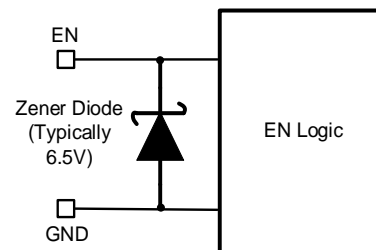

Figure 2: Zener Diode Connection

Connect the EN/DIM input to V_{IN} via a pull-up resistor (R_{EN/DIM_PU}) to limit the EN current (I_{EN}) below 100 μ A. For example, if 12V are connected to V_{IN} , then R_{EN/DIM_PU} should be $\geq 55k\Omega$.

Connecting EN/DIM to a voltage source without a pull-up resistor requires the voltage source amplitude to be limited to $\leq 6V$. This is to prevent damage to the Zener diode.

Pulse-Width Modulation (PWM) Dimming

Apply an external 100Hz to 2kHz PWM waveform to the EN/DIM pin for PWM dimming. The average LED current (I_{LED}) is proportional to the PWM duty. The minimum amplitude of the PWM signal is 1.8V. If the dimming signal is applied before the chip starts up, then the dimming signal's on time (t_{ON}) should be longer than 5ms to ensure soft start finishes. Then I_{OUT} can be built, and after the pulse can decrease. If the dimming signal is applied after soft start finishes, then this 5ms limit is not required.

Figure 3 on page 21 shows the timing while PWM dimming is active.

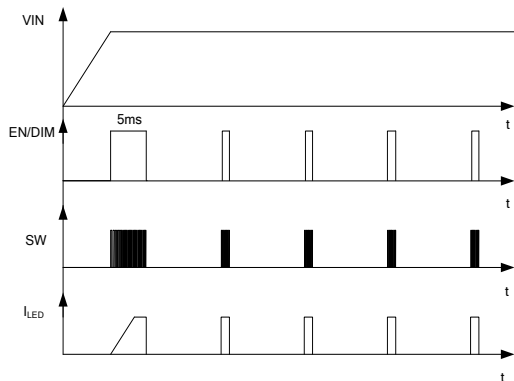

Figure 3: Timing with PWM Dimming

Under-Voltage Lockout (UVLO) Protection

Under-voltage lockout (UVLO) protection protects the chip from operating at an insufficient supply voltage. The UVLO comparator monitors the output voltage (V_{OUT}) of the internal regulator (VCC).

Internal Soft Start (SS)

Soft start (SS) prevents V_{OUT} from overshooting during start-up. When the chip starts up, the internal circuitry generates a soft-start voltage (V_{SS}). If V_{SS} drops below the internal V_{REF} , then V_{SS} overrides V_{REF} , and the EA uses V_{SS} as the reference. If V_{SS} exceeds V_{REF} , the EA uses V_{REF} as the reference.

Float $/FAULT$ during SS (unless thermal shutdown is triggered). If an LED short or open fault occurs during SS, then $/FAULT$ is pulled high. If an LED short or open fault is still present once SS is complete, $/FAULT$ is pulled low.

Fault Indicator

The $/FAULT$ pin is the open drain of a MOSFET, and is used for fault indication. $/FAULT$ should be connected to VCC or another voltage source via a resistor (e.g. 100k Ω). $/FAULT$ is pulled high during normal operation. An LED short fault, LED open fault, or thermal shutdown occurs, $/FAULT$ is pulled down to indicate a fault has occurred.

During a shutdown through EN, $/FAULT$ is pulled high. During a start-up through EN, $/FAULT$ is pulled low once SS is complete. If an LED short or open fault is still present once SS is complete or if thermal shutdown is triggered, $/FAULT$ is pulled low.

During a shutdown with PWM dimming, $/FAULT$

is pulled high. If an LED short or open fault is still present or if thermal shutdown is triggered during a start-up with PWM dimming, $/FAULT$ is pulled low.

Over-Current Protection (OCP)

The MPQ4425C employs cycle by cycle peak current limiting with valley-current detection. The inductor current (I_L) is monitored while the high-side MOSFET (HS-FET) is on. If I_L exceeds the value set by V_{COMP} , then the HS-FET turns off. The low-side MOSFET (LS-FET) turns on to discharge the energy, and I_L decreases. The HS-FET remains off until the inductor valley current drops below the valley current limit (even while the internal clock pulse is high). If I_L does not drop below the valley current limit while the internal clock pulse is high, then the HS-FET skips the clock, and the switching frequency (f_{SW}) decreases to half its nominal value. Both the peak and valley current limits prevent I_L runaway during an overload (OL) or short-circuit (SC) fault.

Thermal Shutdown

Thermal shutdown prevents the chip from operating at exceedingly high temperatures. If the die temperature exceeds the thermal shutdown threshold (typically 170°C), then the entire chip shuts down. Once the temperature drops below 140°C, the device initiates a new SS and resumes normal operation.

Floating Driver and Bootstrap (BST) Charging

An external bootstrap (BST) capacitor (C_{BST}) powers the floating power MOSFET driver. This floating driver has its own UVLO protection, with a 2.2V rising threshold and a 150mV hysteresis. The VIN pin regulates C_{BST} internally via D1, M1, C3, L1, and C4 (see Figure 4). If $(V_{IN} - V_{SW})$ exceeds 5V, then the MPQ4425C (U1) regulates M1 to maintain the BST voltage (V_{BST}) at 5V.

If V_{IN} exceeds V_{SW} , C_{BST} can be charged. If the HS-FET is on, then V_{IN} and V_{SW} are almost the same, and C_{BST} cannot be charged. If the LS-FET is on, the $(V_{IN} - V_{SW})$ can reach its maximum for fast charging. If there is no I_L , then V_{SW} equals V_{OUT} , and the difference between V_{IN} and V_{OUT} can charge C_{BST} . It is recommended to place a 20 Ω resistor between SW and C_{BST} to reduce the SW voltage spike.

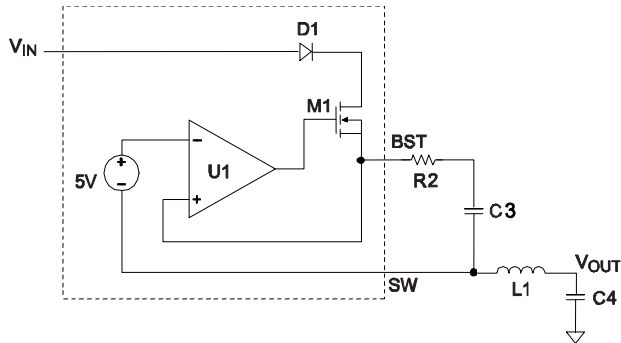

Figure 4: Internal Bootstrap Charging Circuit

Start-Up and Shutdown

If both V_{IN} and V_{EN} exceed their respective thresholds, the part starts up. The reference block starts up first to generate a stable V_{REF} and current. Then the internal regulator starts up to provide a stable supply for the remaining circuitry.

Three events can shut down the chip: V_{IN} going low, V_{EN} going low, and thermal shutdown. During shutdown, the signaling path is blocked to avoid triggering any faults. Then V_{COMP} and the internal supply rail are pulled down. The floating driver is not subject to this shutdown command.

APPLICATION INFORMATION

Setting the LED Current

The external FB resistor (R_{FB}) sets I_{LED} (see Figure 5).

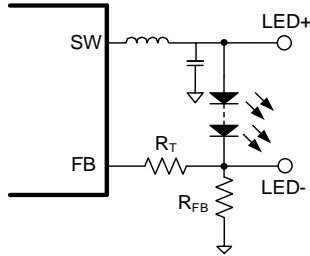

Figure 5: Feedback Network

V_{FB} is 0.195V. I_{LED} can be calculated with Equation (1):

$$I_{LED} = \frac{0.195V}{R_{FB}} \quad (1)$$

The resistor (R_T) sets the loop bandwidth. A lower R_T results in a higher bandwidth, which can cause an insufficient phase margin. To ensure loop stability, choose an R_T value that provides an acceptable tradeoff between the bandwidth and phase margin. Table 1 lists recommended R_{FB} and R_T values for common outputs with 1- or 2-series LEDs.

Table 1: Resistor Values for Common LED Currents

I_{LED} (A)	R_{FB} (m Ω)	R_T (k Ω)
0.5	400 (1%)	200 (1%)
1	200 (1%)	150 (1%)
1.5	133 (1%)	100 (1%)

Selecting the Input Capacitor (C_{IN})

The step-down converter has a discontinuous input current (I_{IN}), and requires a capacitor to supply AC current to the converter while maintaining the DC V_{IN} . Use low-ESR capacitors for the best performance. Ceramic capacitors with X5R or X7R dielectrics are recommended due to their low ESR and small temperature coefficients.

For most applications, a 4.7 μ F to 10 μ F capacitor is sufficient. It is strongly recommended to use another low-value capacitor (e.g. 0.1 μ F) with a small package size (0603) to absorb high-frequency switching noise. Place this capacitor as close to the VIN pin and ground as possible.

Since the input capacitor (C_{IN}) absorbs the input switching current, it requires an adequate ripple current rating. The RMS current in C_{IN} (I_{CIN}) can be estimated with Equation (2):

$$I_{CIN} = I_{LED} \times \sqrt{\frac{V_{OUT}}{V_{IN}} \times \left(1 - \frac{V_{OUT}}{V_{IN}}\right)} \quad (2)$$

The worst-case condition occurs at $V_{IN} = 2 \times V_{OUT}$, which can be calculated with Equation (3):

$$I_{CIN} = \frac{I_{LED}}{2} \quad (3)$$

For simplification, choose a C_{IN} with an RMS current rating greater than half of the maximum load current (I_{LOAD_MAX}).

C_{IN} can be electrolytic, tantalum, or ceramic. When using electrolytic or tantalum capacitors, place a small, high-quality ceramic capacitor (e.g. 0.1 μ F) as close to the IC as possible. When using ceramic capacitors, ensure that they have enough capacitance to provide a sufficient charge to prevent excessive voltage ripple at the input. V_{IN} ripple (ΔV_{IN}) caused by the capacitance can be estimated with Equation (4):

$$\Delta V_{IN} = \frac{I_{LED}}{f_{SW} \times C_{IN}} \times \frac{V_{OUT}}{V_{IN}} \times \left(1 - \frac{V_{OUT}}{V_{IN}}\right) \quad (4)$$

Selecting the Output Capacitor (C_{OUT})

The output capacitor (C_{OUT}) maintains the DC V_{OUT} . Use ceramic, tantalum, or low-ESR electrolytic capacitors. For the best results, use low-ESR capacitors to reduce ΔV_{OUT} . ΔV_{OUT} can be estimated with Equation (5):

$$\Delta V_{OUT} = \frac{V_{OUT}}{f_{SW} \times L} \times \left(1 - \frac{V_{OUT}}{V_{IN}}\right) \times \left(R_{ESR} + \frac{1}{8f_{SW} \times C_{OUT}}\right) \quad (5)$$

For ceramic capacitors, the capacitance dominates the impedance at f_{SW} , and causes the majority of ΔV_{OUT} . For simplification, ΔV_{OUT} can be estimated with Equation (6):

$$\Delta V_{OUT} = \frac{V_{OUT}}{8 \times f_{SW}^2 \times L \times C_{OUT}} \times \left(1 - \frac{V_{OUT}}{V_{IN}}\right) \quad (6)$$

For tantalum or electrolytic capacitors, the ESR dominates the impedance at f_{SW} . For simplification, ΔV_{OUT} can be estimated with Equation (7):

$$\Delta V_{OUT} = \frac{V_{OUT}}{f_{SW} \times L} \times \left(1 - \frac{V_{OUT}}{V_{IN}}\right) \times R_{ESR} \quad (7)$$

The characteristics of C_{OUT} also affect the stability of the regulation system. The MPQ4425C can be optimized for a wide range of capacitances and ESR values.

Selecting the Inductor

For most applications, a $1\mu\text{H}$ to $10\mu\text{H}$ inductor with a DC current rating of at least 25% greater than I_{LOAD_MAX} is recommended. For higher efficiency, choose an inductor with a lower DC resistance. A larger-value inductor results in less ripple current and a lower ΔV_{OUT} ; however, a larger-value inductor also has a larger physical size, higher series resistance, and lower saturation current. A good rule for determining the inductance is to allow the inductor ripple current (ΔI_L) to be approximately 30% of I_{LOAD_MAX} . Then the inductance (L) can be calculated with Equation (8):

$$L = \frac{V_{OUT}}{f_{SW} \times \Delta I_L} \times \left(1 - \frac{V_{OUT}}{V_{IN}}\right) \quad (8)$$

Choose ΔI_L to be approximately 30% of I_{LOAD_MAX} . The peak I_L (I_{L_PEAK}) can be calculated with Equation (9):

$$I_{LP} = I_{LED} + \frac{V_{OUT}}{2f_{SW} \times L} \times \left(1 - \frac{V_{OUT}}{V_{IN}}\right) \quad (9)$$

Setting the V_{IN} Under-Voltage Lockout (UVLO) Threshold

The MPQ4425C has an internal, fixed UVLO threshold. The rising threshold is 3.5V, and the falling threshold is about 3.1V. For applications that require a higher UVLO, place an external resistor divider between the V_{IN} and EN/DIM pins to raise the UVLO threshold (see Figure 6).

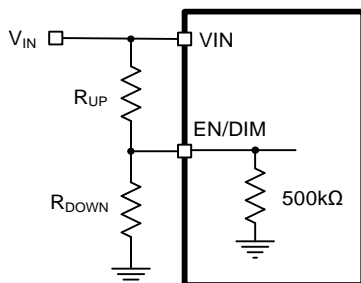

Figure 6: Adjustable UVLO Using EN/DIM Divider

The UVLO rising threshold ($V_{IN_UVLO_RISING}$) can be calculated with Equation (10):

$$V_{IN_UVLO_RISING} = \left(1 + \frac{R_{UP}}{500\text{k}\Omega/R_{DOWN}}\right) \times V_{EN_RISING} \quad (10)$$

Where V_{EN_RISING} is 1.45V.

The UVLO falling threshold ($V_{IN_UVLO_FALLING}$) can be calculated with and Equation (11):

$$V_{IN_UVLO_FALLING} = \left(1 + \frac{R_{UP}}{500\text{k}\Omega/R_{DOWN}}\right) \times V_{EN_FALLING} \quad (11)$$

Where $V_{EN_FALLING}$ is 1V.

Ensure that R_{UP} has a large enough resistance to limit the current flowing through EN/DIM below $100\mu\text{A}$.

BST Resistor and External BST Diode

It is recommended to place a 20Ω resistor in series with C_{BST} to reduce the SW voltage spike. A higher resistance results in a lower SW voltage spike; however, a higher resistance can decrease efficiency.

If the duty cycle is high ($>65\%$), then adding an external BST diode can enhance the efficiency of the regulator. A 2.5V to 5V power supply can be used to power the external BST diode. V_{CC} and V_{OUT} are the best choices supplying the circuit (see Figure 7).

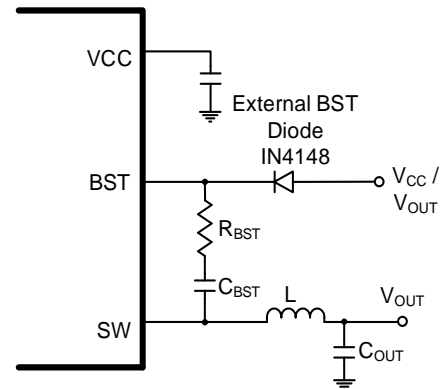

Figure 7: Optional External BST Diode

The recommended external BST diode is the IN4148, and the recommended C_{BST} value is between $0.1\mu\text{F}$ and $1\mu\text{F}$.

PCB Layout Guidelines ⁽¹²⁾

Efficient PCB layout (especially placement of C_{IN}) is critical for stable operation. A 4-layer layout is strongly recommended for improved thermal performance. For the best results, refer to Figure 8 and follow the guidelines below:

1. Connect PGND to a large ground plane. If the bottom layer of the PCB is a ground plane, add multiple vias near PGND.
2. Connect the high-current paths at PGND and VIN using short, direct, and wide traces.
3. Place the ceramic input capacitors – especially the small-packaged input bypass capacitor (0603) – as close to the VIN and PGND pins as possible to minimize high-frequency noise.
4. Keep the connection between the input capacitor and VIN as short and wide as possible.
5. Place the VCC capacitor as close to the VCC and GND pins as possible.
6. Route SW and BST away from sensitive analog areas, such as FB.
7. Place the feedback resistors close to the IC to keep the FB trace as short as possible.
8. Connect the power planes to the internal layers using multiple vias.

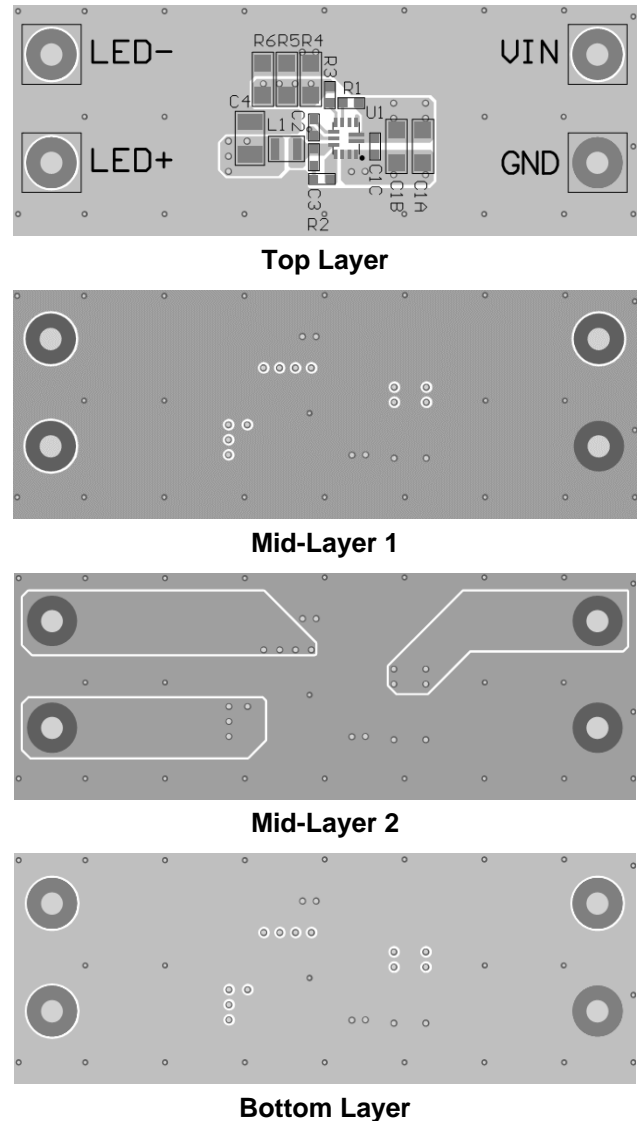
Figure 8: Recommended PCB Layout
Note:

12) The recommended PCB layout is based on Figure 9 on page 26.

TYPICAL APPLICATION CIRCUITS

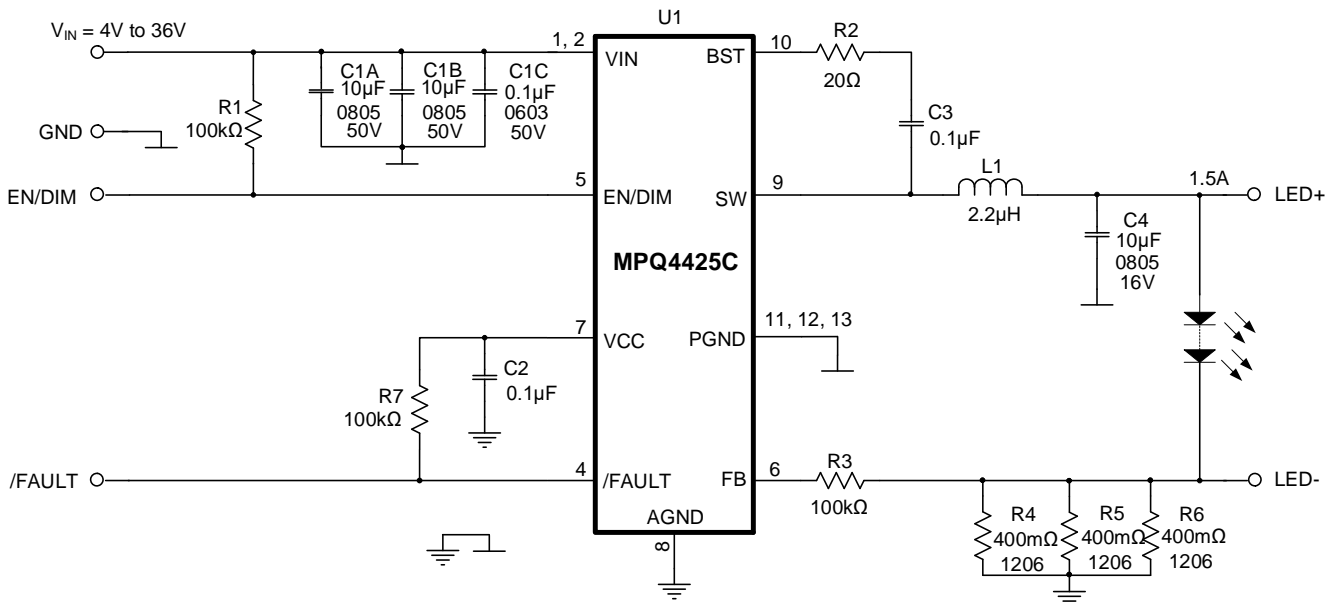

Figure 9: Typical Application Circuit ($I_{LED} = 1.5A$)

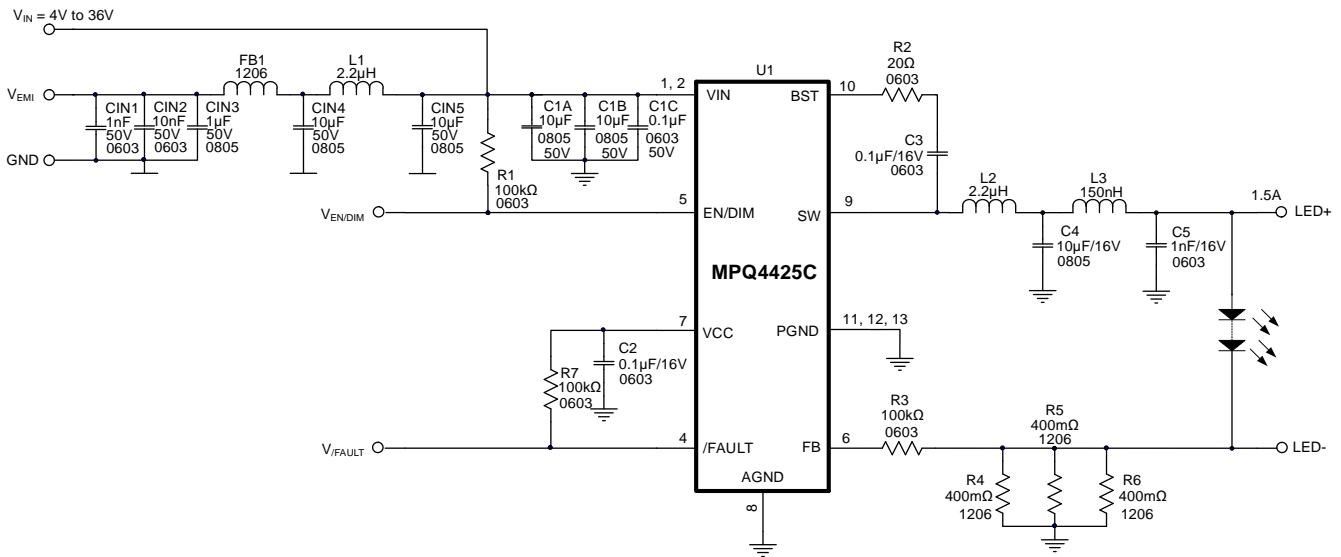
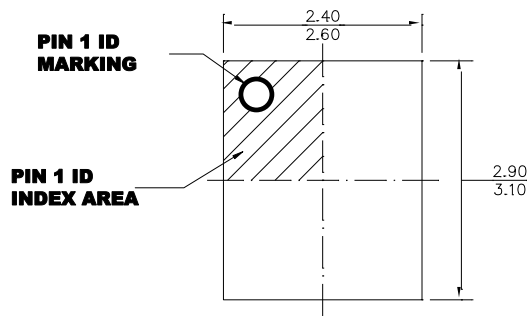
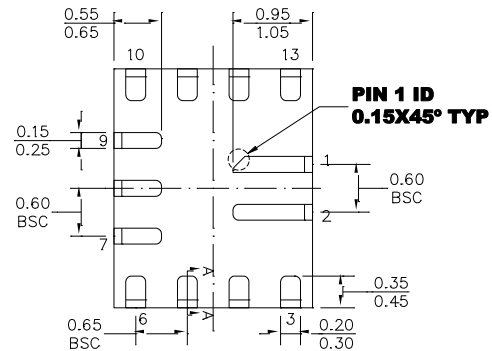
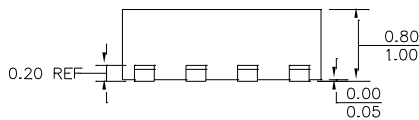
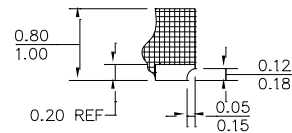
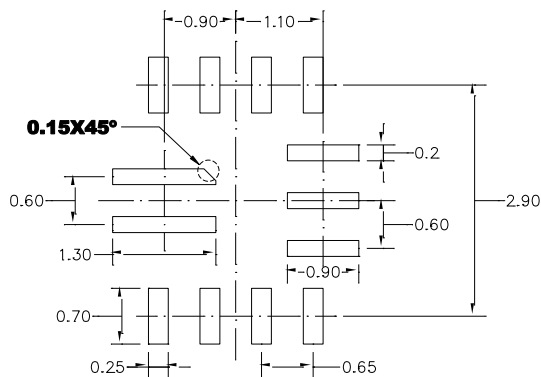
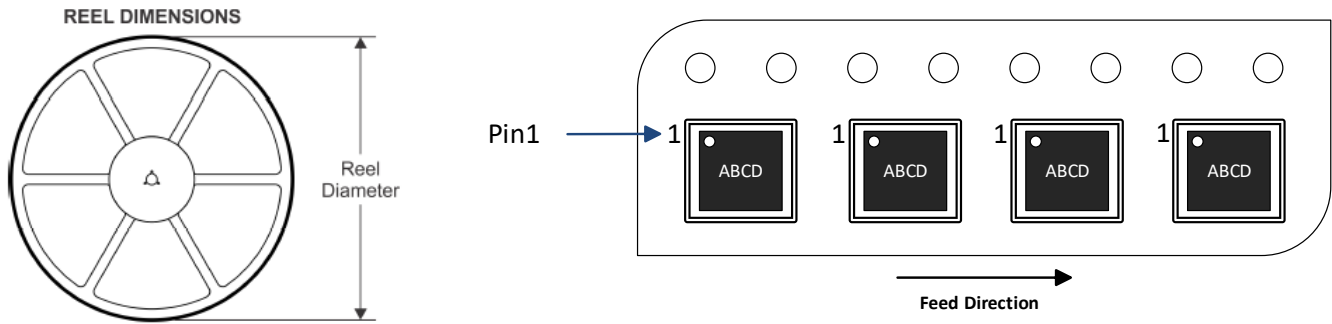

Figure 10: Typical Application Circuit with EMI Filters ($I_{LED} = 1.5A$)

PACKAGE INFORMATION
QFN-13 (2.5mmx3mm)
Wettable Flank

TOP VIEW

BOTTOM VIEW

SIDE VIEW

SECTION A-A

RECOMMENDED LAND PATTERN
NOTE:

- 1) THE LEAD SIDE IS WETTABLE.
- 2) ALL DIMENSIONS ARE IN MILLIMETERS.
- 3) LEAD COPLANARITY SHALL BE 0.08 MILLIMETERS MAX.
- 4) JEDEC REFERENCE IS MO-220.
- 5) DRAWING IS NOT TO SCALE.

CARRIER INFORMATION

Part Number	Package Description	Quantity/ Reel	Quantity/ Tube	Reel Diameter	Carrier Tape Width	Carrier Tape Pitch
MPQ4425CGQBE-AEC1	QFN-13 (2.5mmx3mm)	5000	N/A	13in	12mm	8mm