

## FEATURES

## 64K x 16 MRAM Memory

- 3.3 Volt power supply
- Fast 35ns read/write cycle
- SRAM compatible timing
- Unlimited read & write endurance
- Commercial, Industrial, and Extended Temperatures
- Data non-volatile for >20 years at temperature
- RoHS-compliant TSOP2 and BGA packages available
- All products meet MSL-3 moisture sensitivity level
- Automotive AEC-Q100 Grade 1 option available



44-pin TSOP2



48-ball BGA

## BENEFITS

- One memory replaces FLASH, SRAM, EEPROM and BBSRAM in system for simpler, more efficient designs
- Improves reliability by replacing battery-backed SRAM
- Automatic data protection on power loss



## INTRODUCTION

The **MR0A16A** is a 1,048,576-bit magnetoresistive random access memory (MRAM) device organized as 65,536 words of 16 bits. The **MR0A16A** offers SRAM compatible 35 ns read/write timing with unlimited endurance. Data is always non-volatile for greater than 20 years. Data is automatically protected on power loss by low-voltage inhibit circuitry to prevent writes with voltage out of specification.

**MR0A16A** is the ideal memory solution for applications that must permanently store and retrieve critical data and programs quickly.

The **MR0A16B** is available in a small footprint 48-pin ball grid array (BGA) package and a 44-pin thin small outline package (TSOP Type 2). These packages are compatible with similar low-power SRAM products and other nonvolatile RAM products.

The **MR0A16A** provides highly reliable data storage over a wide range of temperatures. The product is available with commercial temperature (0 to +70 °C), industrial temperature (-40 to +85 °C), extended temperature (-40 to +105 °C), and Automotive AEC-Q100 Grade 1 (-40 to +125°) temperature range options.

## TABLE OF CONTENTS

<b>FEATURES .....</b>	<b>1</b>
<b>BENEFITS.....</b>	<b>1</b>
<b>INTRODUCTION .....</b>	<b>1</b>
<b>BLOCK DIAGRAM AND PIN ASSIGNMENTS.....</b>	<b>4</b>
Figure 1 – Block Diagram .....	4
Table 1 – Pin Functions.....	4
Figure 2 – MR0A16A Package Pinouts .....	5
<b>OPERATING MODES.....</b>	<b>5</b>
Table 2 – Operating Modes.....	5
<b>ABSOLUTE MAXIMUM RATINGS.....</b>	<b>6</b>
Table 3 – Absolute Maximum Ratings.....	6
<b>OPERATING CONDITIONS .....</b>	<b>7</b>
Table 4 – Operating Conditions.....	7
<b>Power Up and Power Down Sequencing .....</b>	<b>8</b>
Figure 3 – Power Up and Power Down Timing .....	8
<b>DC CHARACTERISTICS.....</b>	<b>9</b>
Table 5 – DC Characteristics.....	9
Table 6 – Power Supply Characteristics .....	9
<b>TIMING SPECIFICATIONS .....</b>	<b>10</b>
Table 7 – Capacitance .....	10
Table 8 – AC Measurement Conditions .....	10
Figure 4 – Output Load Test Low and High.....	10
Figure 5 – Output Load Test All Others.....	10
Table 9 – Read Cycle Timing .....	11
Figure 6 – Read Cycle 1 .....	12

## TABLE OF CONTENTS - continued

Figure 7 – Read Cycle 2.....	12
Table 10 – Write Cycle Timing 1 ( $\overline{W}$ Controlled) .....	13
Figure 8 – Write Cycle Timing 1 ( $\overline{W}$ Controlled) .....	14
Table 11 – Write Cycle Timing 2 ( $\overline{E}$ Controlled).....	15
Figure 9 – Write Cycle Timing 2 ( $\overline{E}$ Controlled) .....	15
Table 12 – Write Cycle Timing 3 ( $\overline{LB}/\overline{UB}$ Controlled).....	16
Figure 10 – Write Cycle Timing 3 ( $\overline{UB}/\overline{LB}$ Controlled).....	16
<b>ORDERING INFORMATION .....</b>	<b>17</b>
Table 13 – Part Numbering System.....	17
Table 14 – MR0A16A Ordering Part Numbers .....	18
<b>PACKAGE OUTLINE DRAWINGS.....</b>	<b>19</b>
Figure 11 – 44-pin TSOP2.....	19
Figure 12 – 48-ball FBGA.....	20
<b>REVISION HISTORY .....</b>	<b>21</b>
<b>HOW TO CONTACT US.....</b>	<b>22</b>

**BLOCK DIAGRAM AND PIN ASSIGNMENTS**

**Figure 1 – Block Diagram**

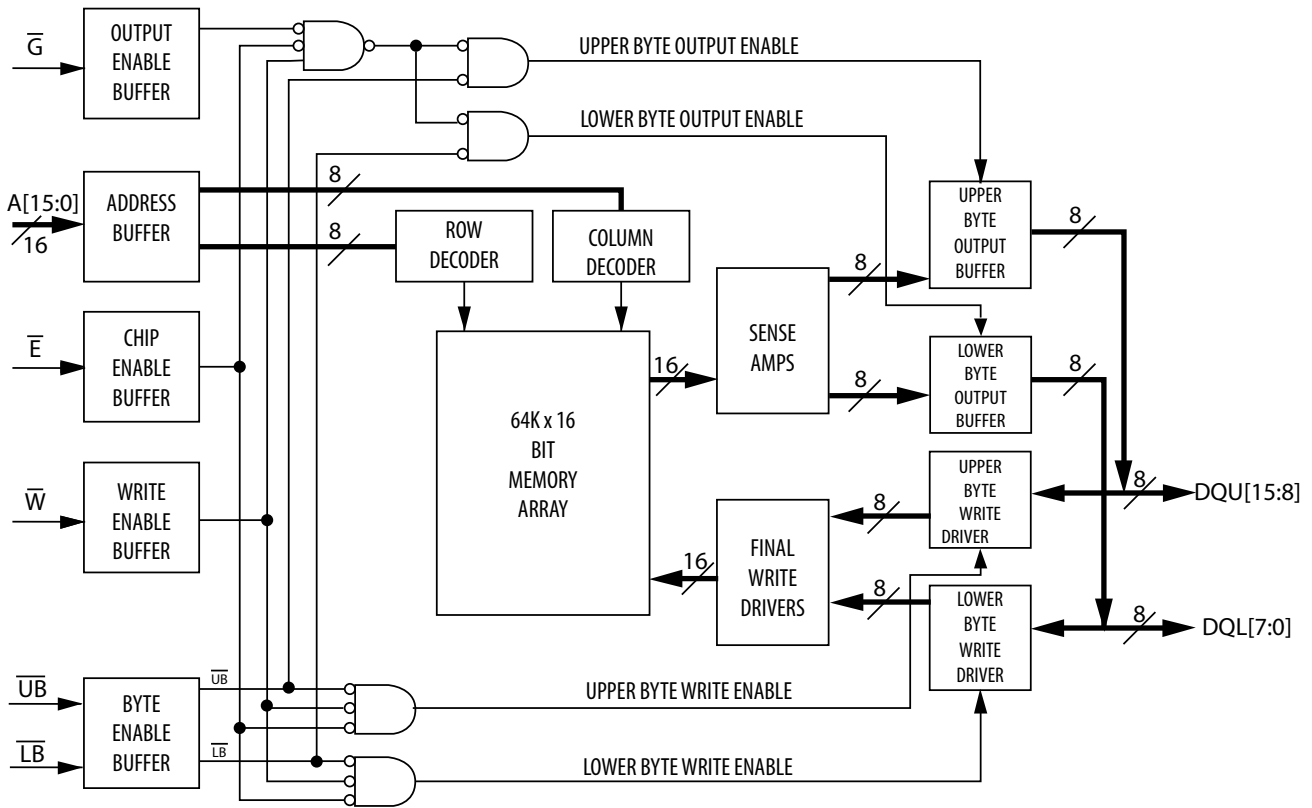

**Table 1 – Pin Functions**

Signal Name	Function
A	Address Input
$\bar{E}$	Chip Enable
$\bar{W}$	Write Enable
$\bar{G}$	Output Enable
$\bar{UB}$	Upper Byte Enable
$\bar{LB}$	Lower Byte Enable
DQ	Data I/O
$V_{DD}$	Power Supply
$V_{SS}$	Ground
DC	Do Not Connect
NC	No Connection

### Figure 2 – MR0A16A Package Pinouts

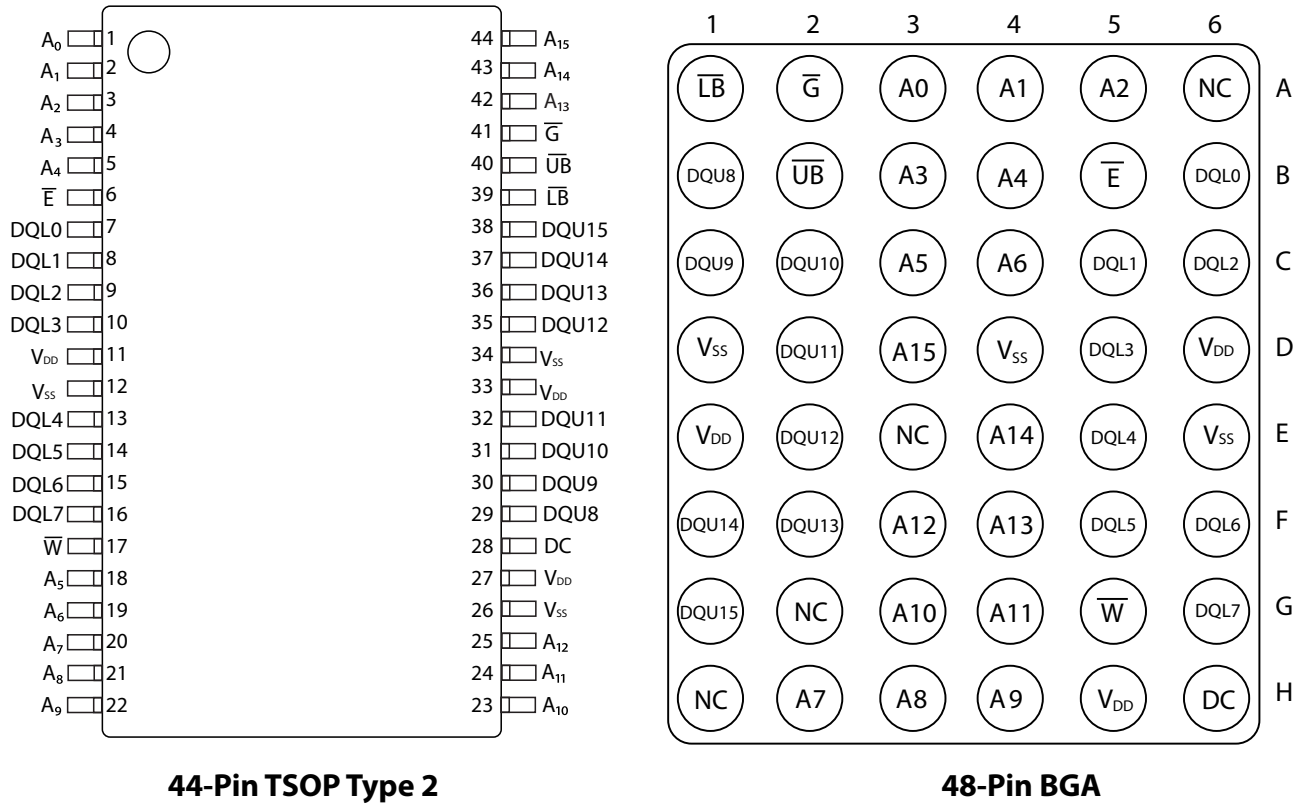

## OPERATING MODES

### Table 2 – Operating Modes

$\bar{E}^1$	$\bar{G}^1$	$\bar{W}^1$	$\bar{L}$ B <sup>1</sup>	$\bar{U}$ B <sup>1</sup>	Mode	V <sub>DD</sub> Current	DQL[7:0] <sup>2</sup>	DQU[15:8] <sup>2</sup>
H	X	X	X	X	Not selected	I <sub>SB1</sub> , I <sub>SB2</sub>	Hi-Z	Hi-Z
L	H	H	X	X	Output disabled	I <sub>DDR</sub>	Hi-Z	Hi-Z
L	X	X	H	H	Output disabled	I <sub>DDR</sub>	Hi-Z	Hi-Z
L	L	H	L	H	Lower Byte Read	I <sub>DDR</sub>	D <sub>Out</sub>	Hi-Z
L	L	H	H	L	Upper Byte Read	I <sub>DDR</sub>	Hi-Z	D <sub>Out</sub>
L	L	H	L	L	Word Read	I <sub>DDR</sub>	D <sub>Out</sub>	D <sub>Out</sub>
L	X	L	L	H	Lower Byte Write	I <sub>DDW</sub>	D <sub>in</sub>	Hi-Z
L	X	L	H	L	Upper Byte Write	I <sub>DDW</sub>	Hi-Z	D <sub>in</sub>
L	X	L	L	L	Word Write	I <sub>DDW</sub>	D <sub>in</sub>	D <sub>in</sub>

Notes:

1. H = high, L = low, X = don't care
2. Hi-Z = high impedance

## ABSOLUTE MAXIMUM RATINGS

This device contains circuitry to protect the inputs against damage caused by high static voltages or electric fields; however, normal precautions should be taken to avoid application of any voltage greater than maximum rated voltages to these high-impedance (Hi-Z) circuits.

The device also contains protection against external magnetic fields. Precautions should be taken to avoid application of any magnetic field more intense than the maximum field intensity specified in the maximum ratings.

Permanent device damage may occur if absolute maximum ratings are exceeded. Functional operation should be restricted to recommended operating conditions. Exposure to excessive voltages or magnetic fields could affect device reliability. <sup>1</sup>

**Table 3 – Absolute Maximum Ratings**

Symbol	Parameter	Temp Range	Package	Value	Unit
V <sub>DD</sub>	Supply voltage <sup>2</sup>	-	-	-0.5 to 4.0	V
V <sub>IN</sub>	Voltage on any pin <sup>2</sup>	-	-	-0.5 to V <sub>DD</sub> + 0.5	V
I <sub>OUT</sub>	Output current per pin	-	-	±20	mA
P <sub>D</sub>	Package power dissipation <sup>3</sup>	-	Note 3	0.600	W
T <sub>BIAS</sub>	Temperature under bias	Commercial	-	-10 to 85	°C
		Industrial	-	-45 to 95	
		Extended	-	-45 to 110	
		AEC Q-100 Grade 1	-	-45 to 130	
T <sub>stg</sub>	Storage Temperature	-	-	-55 to 150	°C
T <sub>Lead</sub>	Lead temperature during solder (3 minute max)	-	-	260	°C
H <sub>max_write</sub>	Maximum magnetic field during write	Commercial	TSOP2, BGA	2,000	A/m
		Industrial, Extended	BGA	2,000	
			TSOP2	10,000	
		AEC-Q100 Grade 1	TSOP2	2,000	
H <sub>max_read</sub>	Maximum magnetic field during read or standby	Commercial	TSOP2, BGA	8,000	A/m
		Industrial, Extended	BGA	8,000	
			TSOP2	10,000	
		AEC-Q100 Grade 1	TSOP2	8,000	

Notes appear on the next page.

Notes: for MR0A16A Absolute Maximum Ratings:

1. Permanent device damage may occur if absolute maximum ratings are exceeded. Functional operation should be restricted to recommended operating conditions. Exposure to excessive voltages or magnetic fields could affect device reliability.
2. All voltages are referenced to  $V_{SS}$ .
3. Power dissipation capability depends on package characteristics and use environment.

## OPERATING CONDITIONS

**Table 4 – Operating Conditions**

Symbol	Parameter	Temp Range	Min	Typical	Max	Unit
$V_{DD}$	Power supply voltage <sup>1</sup>	All	3.0	3.3	3.6	V
$V_{WI}$	Write inhibit voltage	All	2.5	2.7	3.0 <sup>1</sup>	V
$V_{IH}$	Input high voltage	All	2.2	-	$V_{DD} + 0.3$ <sup>2</sup>	V
$V_{IL}$	Input low voltage	All	-0.5 <sup>3</sup>	-	0.8	V
$T_A$	Ambient Temperature under bias	Commercial	0		70	°C
		Industrial	-40		85	
		Extended	-40		105	
		AEC Q-100 Grade 1 <sup>4</sup>	-40		125	

Notes:

1. There is a 2 ms startup time once  $V_{DD}$  exceeds  $V_{DD, (min)}$ . See **Power Up and Power Down Sequencing** below.
2.  $V_{IH(max)} = V_{DD} + 0.3 V_{DC}$ ;  $V_{IH(max)} = V_{DD} + 2.0 V_{AC}$  (pulse width  $\leq 10$  ns) for  $I \leq 20.0$  mA.
3.  $V_{IL(min)} = -0.5 V_{DC}$ ;  $V_{IL(min)} = -2.0 V_{AC}$  (pulse width  $\leq 10$  ns) for  $I \leq 20.0$  mA.
4. AEC-Q100 Grade 1 temperature profile assumes 10% duty cycle at maximum temperature (2 years out of 20 years life.)

### Power Up and Power Down Sequencing

The MRAM is protected from write operations whenever  $V_{DD}$  is less than  $V_{WI}$ . As soon as  $V_{DD}$  exceeds  $V_{DD(min)}$ , there is a startup time of 2 ms before read or write operations can start. This time allows memory power supplies to stabilize.

The  $\bar{E}$  and  $\bar{W}$  control signals should track  $V_{DD}$  on power up to  $V_{DD} - 0.2 V$  or  $V_{IH}$  (whichever is lower) and remain high for the startup time. In most systems, this means that these signals should be pulled up with a resistor so that signal remains high if the driving signal is Hi-Z during power up. Any logic that drives  $\bar{E}$  and  $\bar{W}$  should hold the signals high with a power-on reset signal for longer than the startup time.

During power loss or brownout where  $V_{DD}$  goes below  $V_{WI}$ , writes are protected and a startup time must be observed when power returns above  $V_{DD(min)}$ .

**Figure 3 – Power Up and Power Down Timing**

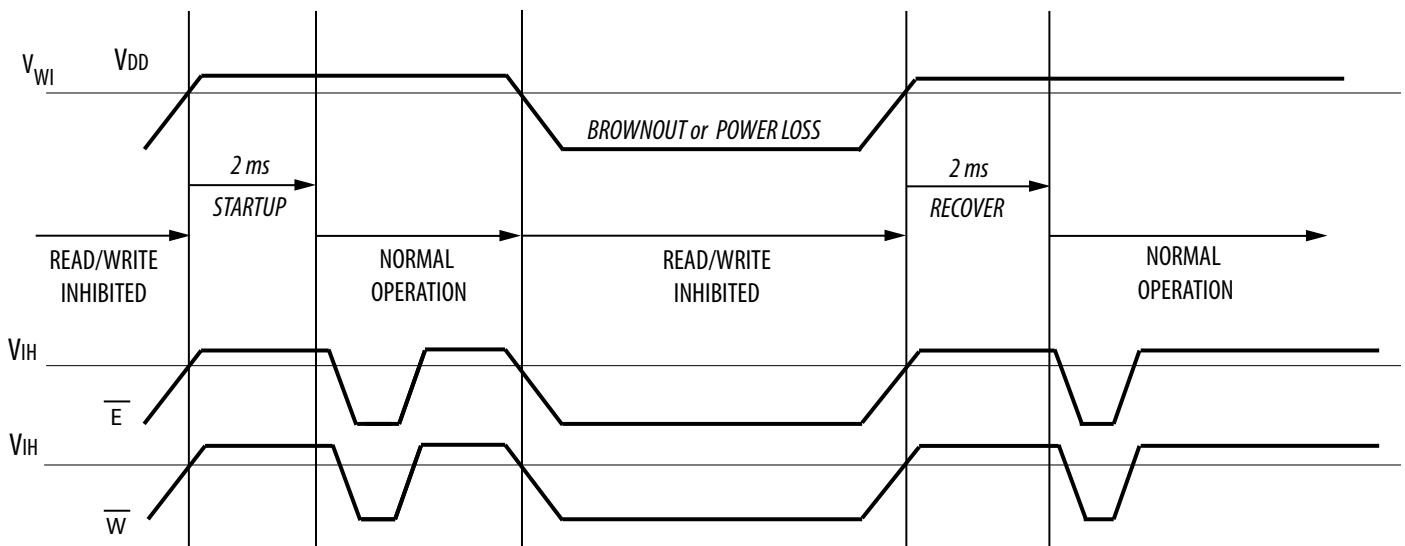



## DC CHARACTERISTICS

### Table 5 – DC Characteristics

Symbol	Parameter	Condition	Min	Max	Unit
$I_{lkg(I)}$	Input leakage current	All	-	$\pm 1$	$\mu\text{A}$
$I_{lkg(O)}$	Output leakage current	All	-	$\pm 1$	$\mu\text{A}$
$V_{OL}$	Output low voltage	$I_{OL} = +4 \text{ mA}$	-	0.4	V
		$I_{OL} = +100 \mu\text{A}$		$V_{SS} + 0.2$	
$V_{OH}$	Output high voltage	$I_{OH} = -4 \text{ mA}$	2.4	-	V
		$I_{OH} = -100 \mu\text{A}$	$V_{DD} - 0.2$		

### Table 6 – Power Supply Characteristics

Symbol	Parameter	Condition	Temp Range	Typical	Max	Unit
$I_{DDR}$	AC active supply current - read modes <sup>1</sup>	$I_{OUT} = 0 \text{ mA}, V_{DD} = \text{max}$	All	55	80	mA
$I_{DDW}$	AC active supply current - write modes <sup>1</sup>	$V_{DD} = \text{max}$	Commercial	105	155	mA
			Industrial	105	165	
			Extended	105	165	
			AEC-Q100 Grade 1	105	165	
$I_{SB1}$	AC standby current	$V_{DD} = \text{max}, E = V_{IH}$ No other restrictions on other inputs	All	18	28	mA
$I_{SB2}$	CMOS standby current	$E \geq V_{DD} - 0.2 \text{ V}$ and $V_{In} \leq V_{SS} + 0.2 \text{ V}$ or $\geq V_{DD} - 0.2 \text{ V}$ $V_{DD} = \text{max}, f = 0 \text{ MHz}$		9	12	mA

Notes:

- All active current measurements are measured with one address transition per cycle and at minimum cycle time.

**TIMING SPECIFICATIONS**

**Table 7 – Capacitance**

Symbol	Parameter <sup>1</sup>	Typical	Max	Unit
$C_{In}$	Address input capacitance	-	6	pF
$C_{In}$	Control input capacitance	-	6	pF
$C_{I/O}$	Input/Output capacitance	-	8	pF

Notes:

- $f = 1.0 \text{ MHz}$ ,  $dV = 3.0 \text{ V}$ ,  $T_A = 25 \text{ }^\circ\text{C}$ , periodically sampled rather than 100% tested.

**Table 8 – AC Measurement Conditions**

Parameter	Value	Unit
Logic input timing measurement reference level	1.5	V
Logic output timing measurement reference level	1.5	V
Logic input pulse levels	0 or 3.0	V
Input rise/fall time	2	ns
Output load for low and high impedance parameters	See Figure 4	
Output load for all other timing parameters	See Figure 5	

**Figure 4 – Output Load Test Low and High**

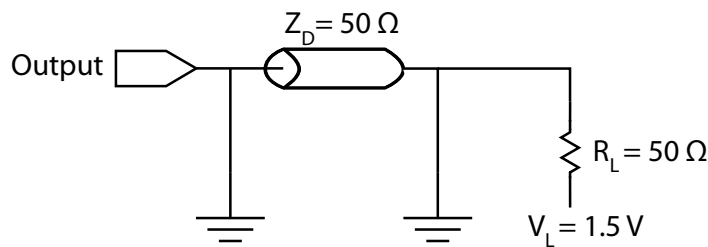

**Figure 5 – Output Load Test All Others**

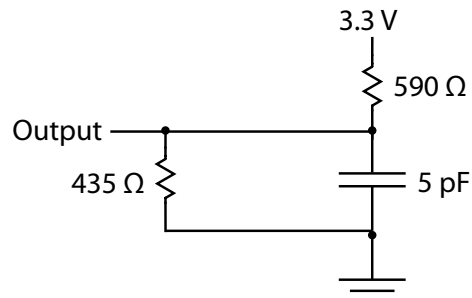

**Table 9 – Read Cycle Timing**

Symbol	Parameter <sup>1</sup>	Min	Max	Unit
t <sub>AVAV</sub>	Read cycle time	35	-	ns
t <sub>AVQV</sub>	Address access time	-	35	ns
t <sub>ELQV</sub>	Enable access time <sup>2</sup>	-	35	ns
t <sub>GLQV</sub>	Output enable access time	-	15	ns
t <sub>BLQV</sub>	Byte enable access time	-	15	ns
t <sub>AXQX</sub>	Output hold from address change	3	-	ns
t <sub>ELQX</sub>	Enable low to output active <sup>3</sup>	3	-	ns
t <sub>GLQX</sub>	Output enable low to output active <sup>3</sup>	0	-	ns
t <sub>BLQX</sub>	Byte enable low to output active <sup>3</sup>	0	-	ns
t <sub>EHQZ</sub>	Enable high to output Hi-Z <sup>3</sup>	0	15	ns
t <sub>GHQZ</sub>	Output enable high to output Hi-Z <sup>3</sup>	0	10	ns
t <sub>BHQZ</sub>	Byte high to output Hi-Z <sup>3</sup>	0	10	ns

**Notes:**

1. W is high for read cycle. Power supplies must be properly grounded and decoupled, and bus contention conditions must be minimized or eliminated during read or write cycles.
2. Addresses valid before or at the same time E goes low.
3. This parameter is sampled and not 100% tested. Transition is measured  $\pm 200$  mV from the steady-state voltage.

**Figure 6 – Read Cycle 1**

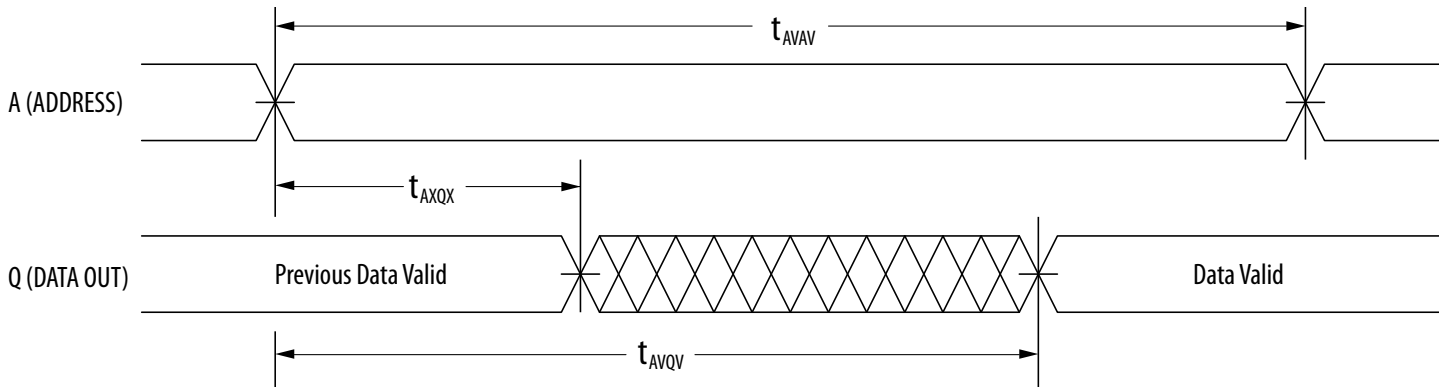

Note: Device is continuously selected ( $\bar{E} \leq V_{IL}$ ,  $\bar{G} \leq V_{IL}$ ).

**Figure 7 – Read Cycle 2**

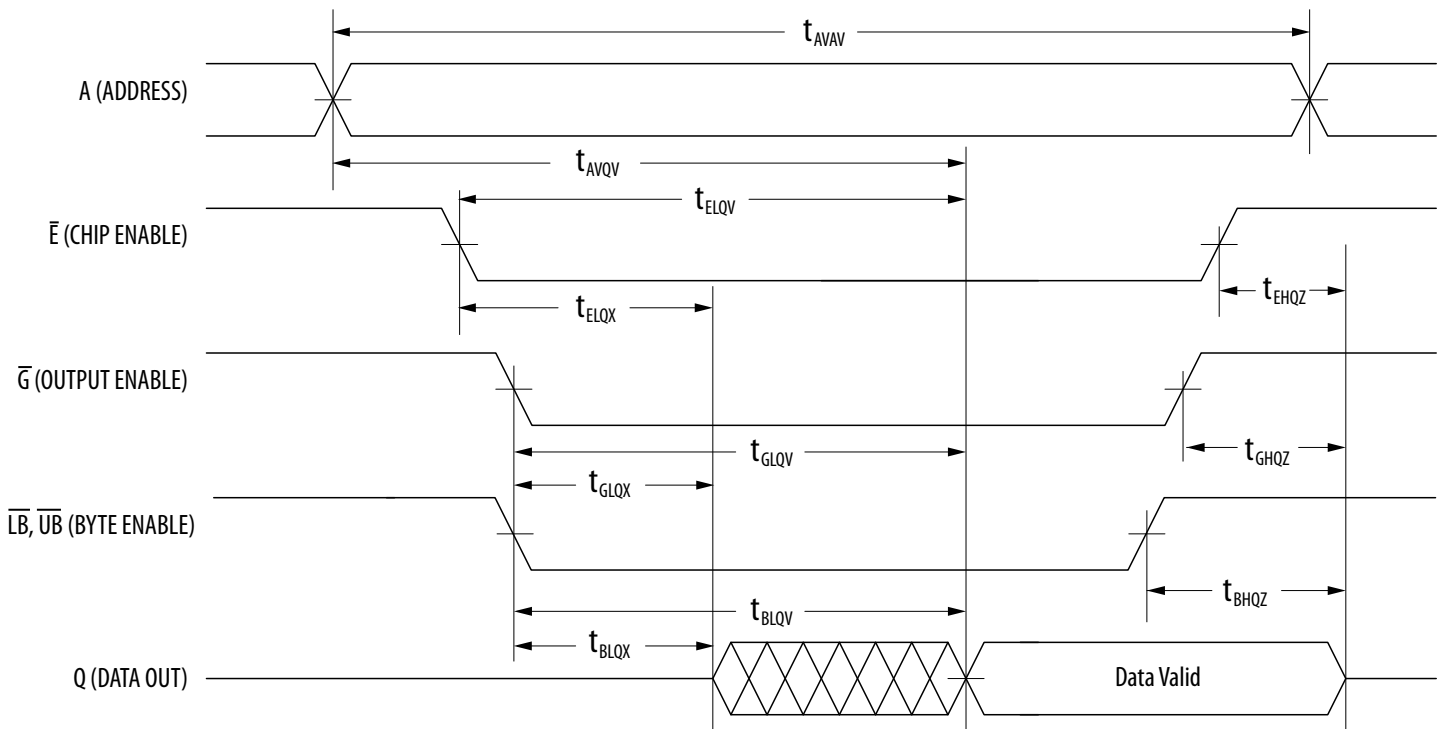

**Table 10 – Write Cycle Timing 1 ( $\overline{W}$  Controlled)**

Symbol	Parameter <sup>1</sup>	Min	Max	Unit
$t_{AVAV}$	Write cycle time <sup>2</sup>	35	-	ns
$t_{AVWL}$	Address set-up time	0	-	ns
$t_{AVWH}$	Address valid to end of write (G high)	18	-	ns
$t_{AVWL}$	Address valid to end of write (G low)	20	-	ns
$t_{WLWH}$ $t_{WLEH}$	Write pulse width (G high)	15	-	ns
$t_{WLWH}$ $t_{WLEH}$	Write pulse width (G low)	15	-	ns
$t_{DVWH}$	Data valid to end of write	10	-	ns
$t_{WHDX}$	Data hold time	0	-	ns
$t_{WLQZ}$	Write low to data Hi-Z <sup>3</sup>	0	12	ns
$t_{WHQX}$	Write high to output active <sup>3</sup>	3	-	ns
$t_{WHAX}$	Write recovery time	12	-	ns

**Notes:**

1. All write occurs during the overlap of  $\overline{E}$  low and  $\overline{W}$  low. Power supplies must be properly grounded and decoupled and bus contention conditions must be minimized or eliminated during read and write cycles. If  $\overline{G}$  goes low at the same time or after  $\overline{W}$  goes low, the output will remain in a high impedance state. After  $\overline{W}$  or  $\overline{E}$  has been brought high, the signal must remain in steady-state high for a minimum of 2 ns. The minimum time between  $\overline{E}$  being asserted low in one cycle to  $\overline{E}$  being asserted low in a subsequent cycle is the same as the minimum cycle time allowed for the device.
2. All write cycle timings are referenced from the last valid address to the first transition address.
3. This parameter is sampled and not 100% tested. Transition is measured  $\pm 200$  mV from the steady-state voltage. At any given voltage or temperature,  $t_{WLQZ}(\max) < t_{WHQX}(\min)$

**Figure 8 – Write Cycle Timing 1 ( $\overline{W}$  Controlled)**

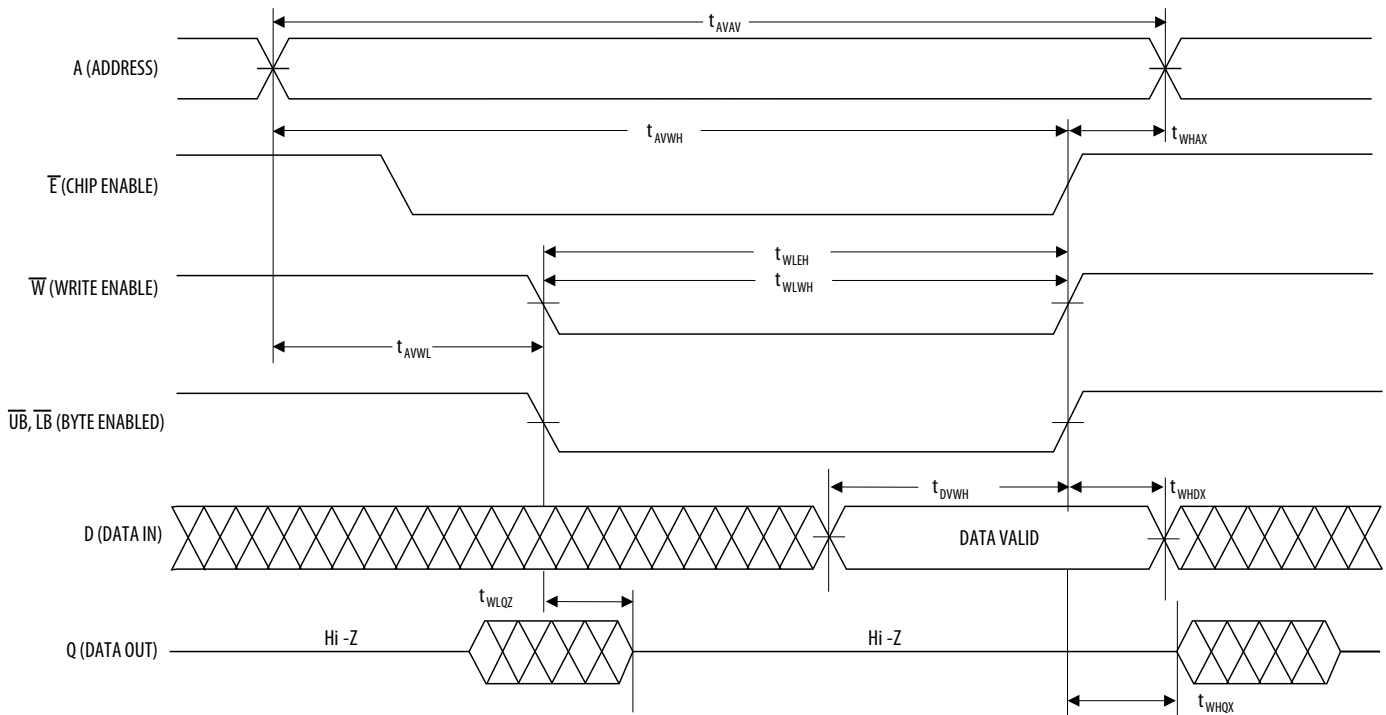

### Table 11 – Write Cycle Timing 2 (E Controlled)

Symbol	Parameter <sup>1</sup>	Min	Max	Unit
$t_{AVAV}$	Write cycle time <sup>2</sup>	35	-	ns
$t_{AVEL}$	Address set-up time	0	-	ns
$t_{AVEH}$	Address valid to end of write (G high)	18	-	ns
$t_{AVEH}$	Address valid to end of write (G low)	20	-	ns
$t_{ELEH}$ $t_{ELWH}$	Enable to end of write (G high)	15	-	ns
$t_{ELEH}$ $t_{ELWH}$	Enable to end of write (G low) <sup>3</sup>	15	-	ns
$t_{DVEH}$	Data valid to end of write	10	-	ns
$t_{EHDX}$	Data hold time	0	-	ns
$t_{EHAX}$	Write recovery time	12	-	ns

Notes:

1. All write occurs during the overlap of  $\bar{E}$  low and  $\bar{W}$  low. Power supplies must be properly grounded and decoupled and bus contention conditions must be minimized or eliminated during read and write cycles. If  $\bar{G}$  goes low at the same time or after  $\bar{W}$  goes low, the output will remain in a high impedance state. After  $\bar{W}$  or  $\bar{E}$  has been brought high, the signal must remain in steady-state high for a minimum of 2 ns. The minimum time between  $\bar{E}$  being asserted low in one cycle to  $\bar{E}$  being asserted low in a subsequent cycle is the same as the minimum cycle time allowed for the device.
2. All write cycle timings are referenced from the last valid address to the first transition address.
3. If  $\bar{E}$  goes low at the same time or after  $\bar{W}$  goes low, the output will remain in a high-impedance state. If  $\bar{E}$  goes high at the same time or before  $\bar{W}$  goes high, the output will remain in a high-impedance state.

### Figure 9 – Write Cycle Timing 2 (E Controlled)

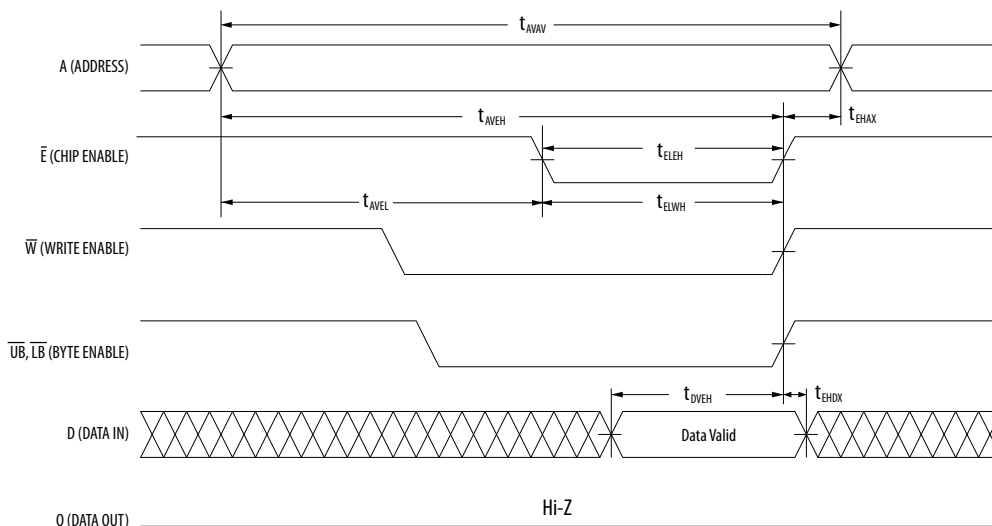

**Table 12 – Write Cycle Timing 3 ( $\overline{LB}/\overline{UB}$  Controlled)**

Symbol	Parameter <sup>1</sup>	Min	Max	Unit
$t_{AVAV}$	Write cycle time <sup>2</sup>	35	-	ns
$t_{AVBL}$	Address set-up time	0	-	ns
$t_{AVBH}$	Address valid to end of write (G high)	18	-	ns
	Address valid to end of write (G low)	20	-	ns
$t_{BLEH}$ $t_{BLWH}$	Write pulse width (G high)	15	-	ns
$t_{BLEH}$ $t_{BLWH}$	Write pulse width (G low)	15	-	ns
$t_{DVBH}$	Data valid to end of write	10	-	ns
$t_{BHDX}$	Data hold time	0	-	ns
$t_{BHAX}$	Write recovery time	12	-	ns

Notes:

1. All write occurs during the overlap of  $\overline{E}$  low and  $\overline{W}$  low. Power supplies must be properly grounded and decoupled and bus contention conditions must be minimized or eliminated during read and write cycles. If  $\overline{G}$  goes low at the same time or after  $\overline{W}$  goes low, the output will remain in a high impedance state. After  $\overline{W}$ ,  $\overline{E}$  or  $\overline{UB}/\overline{LB}$  has been brought high, the signal must remain in steady-state high for a minimum of 2 ns. If both byte control signals are asserted, the two signals must have no more than 2 ns skew between them. The minimum time between  $\overline{E}$  being asserted low in one cycle to  $\overline{E}$  being asserted low in a subsequent cycle is the same as the minimum cycle time allowed for the device.
2. All write cycle timings are referenced from the last valid address to the first transition address.

**Figure 10 – Write Cycle Timing 3 ( $\overline{UB}/\overline{LB}$  Controlled)**

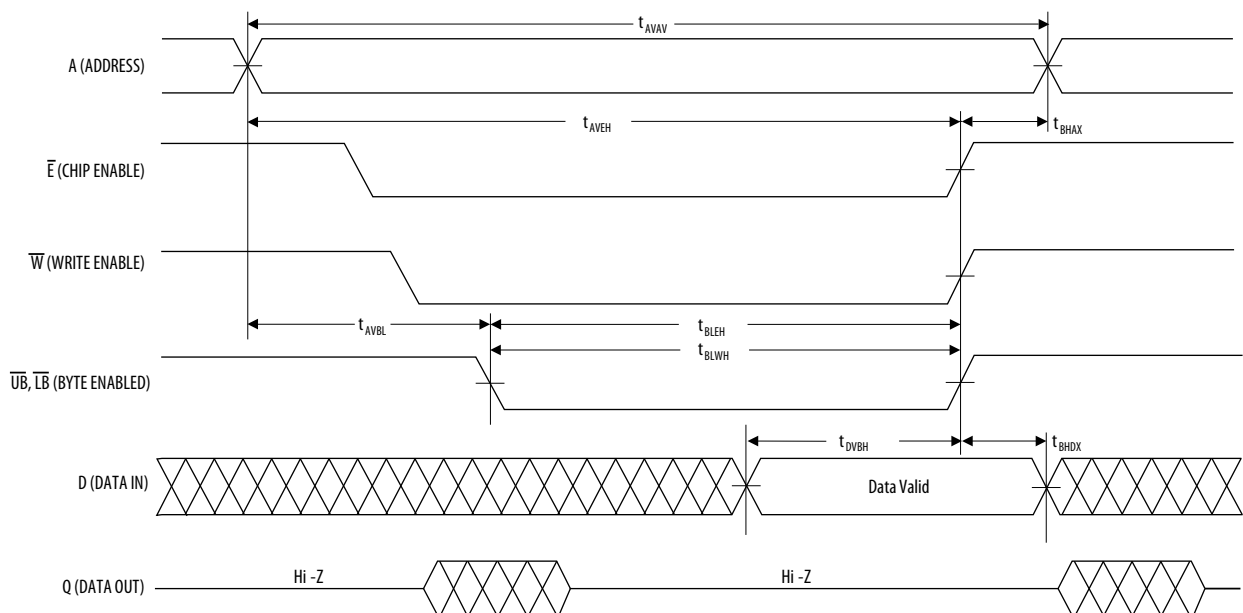



## ORDERING INFORMATION

**Table 13 – Part Numbering System**

	Memory	Density	Type	I/O Width	Rev.	Temp	Package	Speed	Packing	Grade
<b>Example Ordering Part Number</b>	MR	0	A	16	A	C	MA	35	R	
MRAM	MR									
256 Kb	256									
1 Mb	0									
4 Mb	2									
16 Mb	4									
Async 3.3v	A									
Async 3.3v Vdd and 1.8v Vddq	D									
Async 3.3v Vdd and 1.8v Vddq with 2.7v min. Vdd	DL									
8-bit	8									
16-bit	16									
Rev A	A									
Rev B	B									
Commercial	0 to 70°C	Blank								
Industrial	-40 to 85°C	C								
Extended	-40 to 105°C	V								
AEC Q-100 Grade 1	-40 to 125°C	M								
44-TSOP-2	YS									
48-FBGA	MA									
16-SOIC	SC									
32-SOIC	SO									
35 ns	35									
45 ns	45									
Tray	Blank									
Tape and Reel	R									
Engineering Samples	ES									
Customer Samples	Blank									
Mass Production	Blank									

**Table 14 – MR0A16A Ordering Part Numbers**

Temp Grade	Temp	Package	Shipping	Ordering Part Number
Commercial	0 to +70 °C	44-TSOP2	Tray	MR0A16AYS35
			Tape and Reel	MR0A16AYS35R
		48-BGA	Tray	MR0A16AMA35
			Tape and Reel	MR0A16AMA35R
Industrial	-40 to +85 °C	44-TSOP2	Tray	MR0A16ACYS35
			Tape and Reel	MR0A16ACYS35R
		48-BGA	Tray	MR0A16ACMA35
			Tape and Reel	MR0A16ACMA35R
Extended	-40 to +105 °C	44-TSOP2	Tray	MR0A16AVYS35
			Tape and Reel	MR0A16AVYS35R
		48-BGA	Tray	MR0A16AVMA35
			Tape and Reel	MR0A16AVMA35R
AEC-Q100 Grade 1	-40 to 125 °C	44-TSOP2	Tray	MR0A16AMYS35
			Tape and Reel	MR0A16AMYS35R

**PACKAGE OUTLINE DRAWINGS**

**Figure 11 – 44-pin TSOP2**

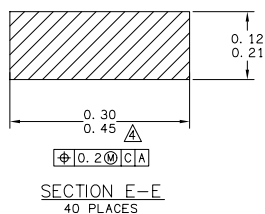
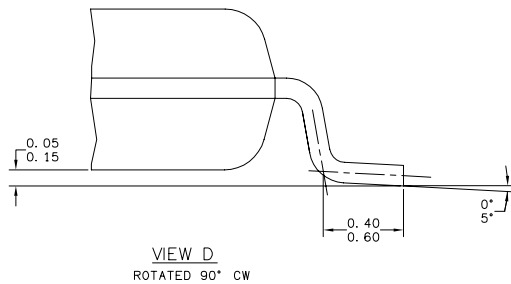
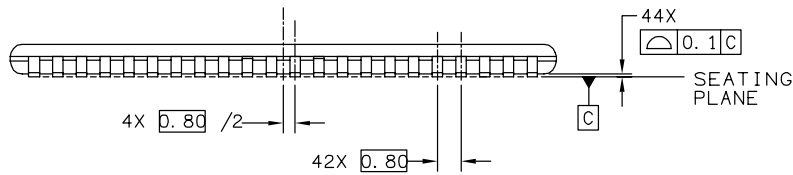
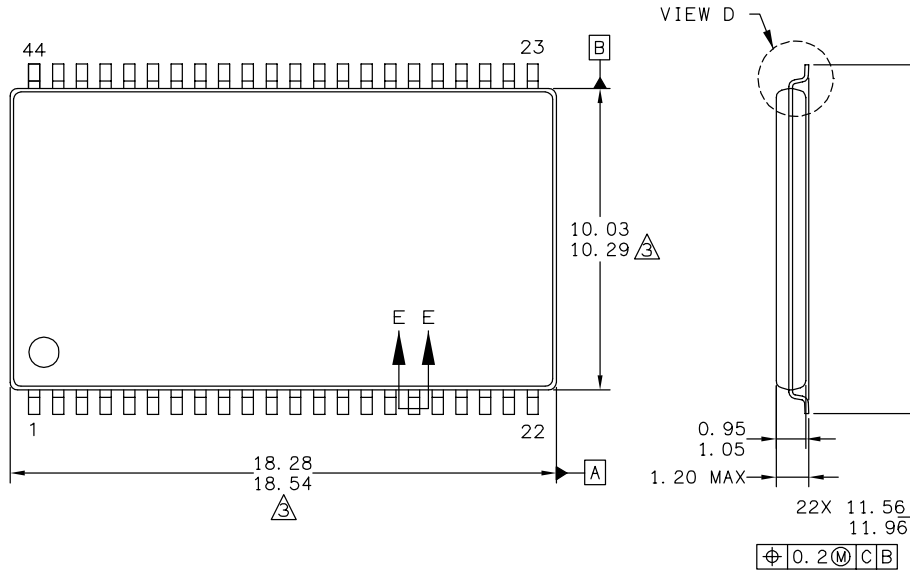

**Notes:**

1. Dimensions and tolerances per ASME Y14.5M - 1994.
2. Dimensions in Millimeters.
3. Dimensions do not include mold protrusion.
4. Dimension does not include DAM bar protrusions.
5. DAM Bar protrusion shall not cause the lead width to exceed 0.58.

**Figure 12 – 48-ball BGA Package Outline**

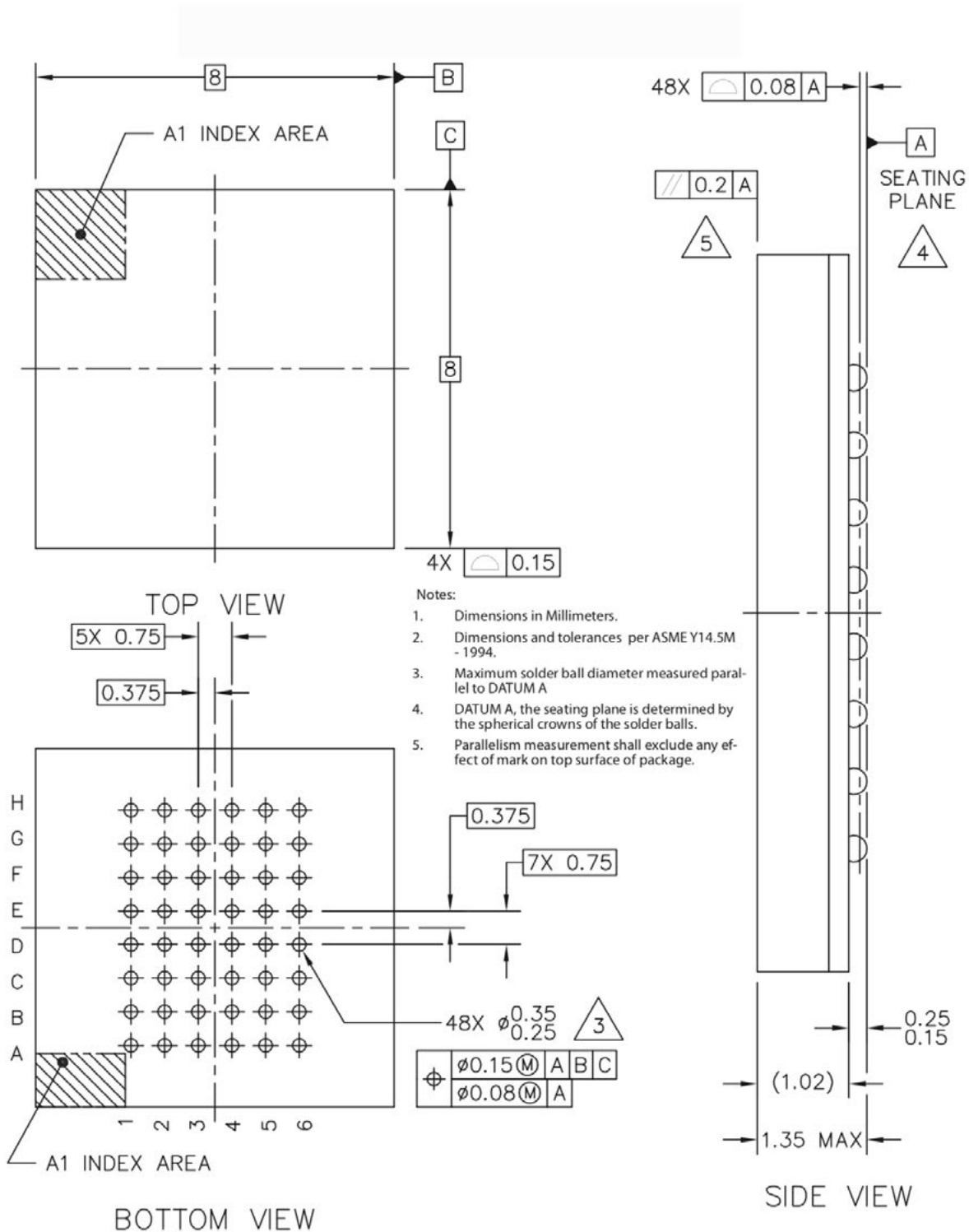

## REVISION HISTORY

Revision	Date	Description of Change
0	Jun 18, 2007	Initial Advanced Information Release
1	Sept 21, 2007	Table 6, Applied Values to TBD's in IDD Specifications
2	Nov 12, 2007	Table 2, Changed IDDA to IDDR or IDDW
3	Sep 12, 2008	Reformat Datasheet for EverSpin, Add BGA Packaging Information, Add Tape & Reel Part Numbers, Add Power Sequencing Info, Correct IOH spec of VOH to -100 uA, Correct ac Test Conditions.
4	Feb 28, 2011	Add TSOPII Lead Cross-Section, Add Production Note. Converted to new document format.
5	Dec 9, 2011	Figure 2.1 cosmetic update. Figure 5.2 BGA package outline drawing revised for ball size. Updated logo and contact information.
6	August 6, 2012	Revised Table 1 and Figure 1 to be correct for x16 device. Revised magnetic immunity ratings for TSOP2 Industrial Grade. Revised figure 3. Complete document reformat and restructure.
7	October 14, 2013	Added AEC-Q100 Grade 1 product option.
8	February 19, 2015	Revised package outline for BGA. Ball size to 0.25 / 0.35 mm.
8.1	May 19, 2015	Revised contact information on Contact Us page.
8.2	June 11, 2015	Correction to Japan Sales Office telephone number.
8.3	March 23, 2018	Revised contact information on Contact Us page.