

# RF Power LDMOS Transistors

## High Ruggedness N-Channel Enhancement-Mode Lateral MOSFETs

These devices are designed for use in HF and VHF communications, industrial, scientific and medical (ISM) and broadcast and aerospace applications. The devices are extremely rugged and exhibit high performance up to 250 MHz.

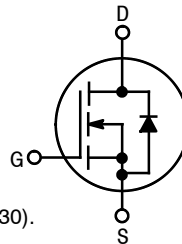
**Typical Performance:**  $V_{DD} = 50$  Vdc

Frequency (MHz)	Signal Type	$P_{out}$ (W)	$G_{ps}$ (dB)	$\eta_D$ (%)
13.56 (1)	CW	130 CW	27.1	79.6
27 (2)	CW	125 CW	24.9	79.6
40.68 (3)	CW	120 CW	23.8	81.5
50 (4)	CW	119 CW	22.8	82.1
81.36 (5)	CW	130 CW	23.2	80.8
87.5–108 (6,7)	CW	115 CW	20.6	76.8
136–174 (7,8)	CW	104 CW	21.2	76.5
230 (9)	Pulse (100 $\mu$ sec, 20% Duty Cycle)	115 Peak	21.1	76.7

### Load Mismatch/Ruggedness

Frequency (MHz)	Signal Type	VSWR	$P_{in}$ (W)	Test Voltage	Result
40.68	CW	> 65:1 at all Phase Angles	0.64 CW	50	No Device Degradation
230	Pulse (100 $\mu$ sec, 20% Duty Cycle)	> 65:1 at all Phase Angles	1.8 Peak (3 dB Overdrive)	50	No Device Degradation

1. Measured in 13.56 MHz reference circuit (page 5).
2. Measured in 27 MHz reference circuit (page 9).
3. Measured in 40.68 MHz reference circuit (page 13).
4. Measured in 50 MHz reference circuit (page 17).
5. Measured in 81.36 MHz reference circuit (page 21).
6. Measured in 87.5–108 MHz broadband reference circuit (page 25).
7. The values shown are the center band performance numbers across the indicated frequency range.
8. Measured in 136–174 MHz VHF broadband reference circuit (page 30).
9. Measured in 230 MHz fixture (page 34).



### Features

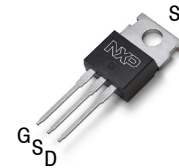
- Mirror pinout versions (A and B) to simplify use in a push-pull, two-up configuration
- Characterized from 30 to 50 V
- Suitable for linear application
- Integrated ESD protection with greater negative gate-source voltage range for improved Class C operation
- Included in NXP product longevity program with assured supply for a minimum of 15 years after launch

### Typical Applications

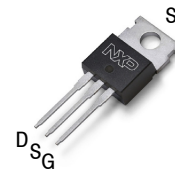
- Industrial, scientific, medical (ISM)
  - Laser generation
  - Plasma etching
  - Particle accelerators
  - MRI and other medical applications
  - Industrial heating, welding and drying systems
- Radio and VHF TV broadcast
- HF and VHF communications
- Switch mode power supplies

**MRF101AN**  
**MRF101BN**

**1.8–250 MHz, 100 W CW, 50 V**  
**WIDEBAND**  
**RF POWER LDMOS TRANSISTORS**



**TO-220-3**  
**MRF101AN**



**TO-220-3**  
**MRF101BN**



**Backside**

Note: Exposed backside of the package and tab also serves as a source terminal for the transistor.

**Table 1. Maximum Ratings**

Rating	Symbol	Value	Unit
Drain-Source Voltage	$V_{DSS}$	-0.5, +133	Vdc
Gate-Source Voltage	$V_{GS}$	-6.0, +10	Vdc
Operating Voltage	$V_{DD}$	50	Vdc
Storage Temperature Range	$T_{stg}$	-65 to +150	°C
Case Operating Temperature Range	$T_C$	-40 to +150	°C
Operating Junction Temperature Range (1,2)	$T_J$	-40 to +175	°C
Total Device Dissipation @ $T_C = 25^\circ\text{C}$ Derate above 25°C	$P_D$	182 0.91	W W/°C

**Table 2. Thermal Characteristics**

Characteristic	Symbol	Value (2,3)	Unit
Thermal Resistance, Junction to Case CW: Case Temperature 77°C, 150 W CW, 50 Vdc, $I_{DQ} = 100$ mA, 40.68 MHz	$R_{\theta JC}$	1.1	°C/W
Thermal Impedance, Junction to Case Pulse: Case Temperature 73°C, 113 W Peak, 100 $\mu\text{sec}$ Pulse Width, 20% Duty Cycle, 50 Vdc, $I_{DQ} = 100$ mA, 230 MHz	$Z_{\theta JC}$	0.37	°C/W

**Table 3. ESD Protection Characteristics**

Test Methodology	Class
Human Body Model (per JS-001-2017)	1B, passes 1000 V
Charge Device Model (per JS-002-2014)	C3, passes 1200 V

**Table 4. Electrical Characteristics** ( $T_A = 25^\circ\text{C}$  unless otherwise noted)

Characteristic	Symbol	Min	Typ	Max	Unit
----------------	--------	-----	-----	-----	------

**Off Characteristics**

Gate-Source Leakage Current ( $V_{GS} = 5$ Vdc, $V_{DS} = 0$ Vdc)	$I_{GSS}$	—	—	1	$\mu\text{Adc}$
Drain-Source Breakdown Voltage ( $V_{GS} = 0$ Vdc, $I_D = 50$ mAdc)	$V_{(BR)DSS}$	133	—	—	Vdc
Zero Gate Voltage Drain Leakage Current ( $V_{DS} = 100$ Vdc, $V_{GS} = 0$ Vdc)	$I_{DSS}$	—	—	10	$\mu\text{Adc}$

**On Characteristics**

Gate Threshold Voltage ( $V_{DS} = 10$ Vdc, $I_D = 290$ $\mu\text{Adc}$ )	$V_{GS(th)}$	1.7	2.2	2.7	Vdc
Gate Quiescent Voltage ( $V_{DS} = 50$ Vdc, $I_D = 100$ mAdc)	$V_{GS(Q)}$	—	2.5	—	Vdc
Drain-Source On-Voltage ( $V_{GS} = 10$ Vdc, $I_D = 1$ Adc)	$V_{DS(on)}$	—	0.45	—	Vdc
Forward Transconductance ( $V_{DS} = 10$ Vdc, $I_D = 8.8$ Adc)	$g_{fs}$	—	7.1	—	S

1. Continuous use at maximum temperature will affect MTF.

2. MTF calculator available at <http://www.nxp.com/RF/calculators>.

3. Refer to AN1955, *Thermal Measurement Methodology of RF Power Amplifiers*. Go to <http://www.nxp.com/RF> and search for AN1955.

(continued)

**Table 4. Electrical Characteristics** ( $T_A = 25^\circ\text{C}$  unless otherwise noted) (continued)

Characteristic	Symbol	Min	Typ	Max	Unit
<b>Dynamic Characteristics</b>					
Reverse Transfer Capacitance ( $V_{DS} = 50\text{ Vdc} \pm 30\text{ mV(rms)ac}$ @ 1 MHz, $V_{GS} = 0\text{ Vdc}$ )	$C_{rss}$	—	0.96	—	pF
Output Capacitance ( $V_{DS} = 50\text{ Vdc} \pm 30\text{ mV(rms)ac}$ @ 1 MHz, $V_{GS} = 0\text{ Vdc}$ )	$C_{oss}$	—	43.4	—	pF
Input Capacitance ( $V_{DS} = 50\text{ Vdc}$ , $V_{GS} = 0\text{ Vdc} \pm 30\text{ mV(rms)ac}$ @ 1 MHz)	$C_{iss}$	—	149	—	pF

**Typical Performance — 230 MHz** (In NXP 230 MHz Fixture, 50 ohm system)  $V_{DD} = 50\text{ Vdc}$ ,  $I_{DQ} = 100\text{ mA}$ ,  $P_{in} = 0.9\text{ W}$ ,  $f = 230\text{ MHz}$ , 100  $\mu\text{sec}$  Pulse Width, 20% Duty Cycle

Common-Source Amplifier Output Power	$P_{out}$	—	115	—	W
Power Gain	$G_{ps}$	—	21.1	—	dB
Drain Efficiency	$\eta_D$	—	76.7	—	%

**Table 5. Load Mismatch/Ruggedness** (In NXP 230 MHz Fixture, 50 ohm system)  $I_{DQ} = 100\text{ mA}$ 

Frequency (MHz)	Signal Type	VSWR	$P_{in}$ (W)	Test Voltage, $V_{DD}$	Result
230	Pulse (100 $\mu\text{sec}$ , 20% Duty Cycle)	> 65:1 at all Phase Angles	1.8 Peak (3 dB Overdrive)	50	No Device Degradation

**Table 6. Ordering Information — Device**

Device	Shipping Information	Package
MRF101AN	MPQ = 250 devices (50 devices per tube, 5 tubes per box)	TO-220-3L (Pin 1: Gate, Pin 2: Source, Pin 3: Drain)
MRF101BN		TO-220-3L (Pin 1: Drain, Pin 2: Source, Pin 3: Gate)

**Table 7. Ordering Information — Reference Circuits**

Order Number	Description
MRF101AN-13MHZ	MRF101AN 13.56 MHz Reference Circuit
MRF101AN-27MHZ	MRF101AN 27 MHz Reference Circuit
MRF101AN-40MHZ	MRF101AN 40.68 MHz Reference Circuit
MRF101AN-50MHZ	MRF101AN 50 MHz Reference Circuit
MRF101AN-81MHZ	MRF101AN 81.36 MHz Reference Circuit
MRF101AN-88MHZ	MRF101AN 87.5–108 MHz Reference Circuit
MRF101AN-VHF	MRF101AN 136–174 MHz Reference Circuit
MRF101AN-230MHZ	MRF101AN 230 MHz Test Fixture

## TYPICAL CHARACTERISTICS

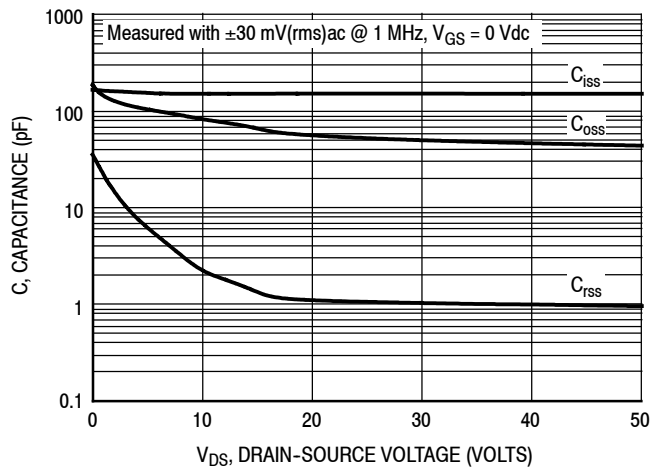
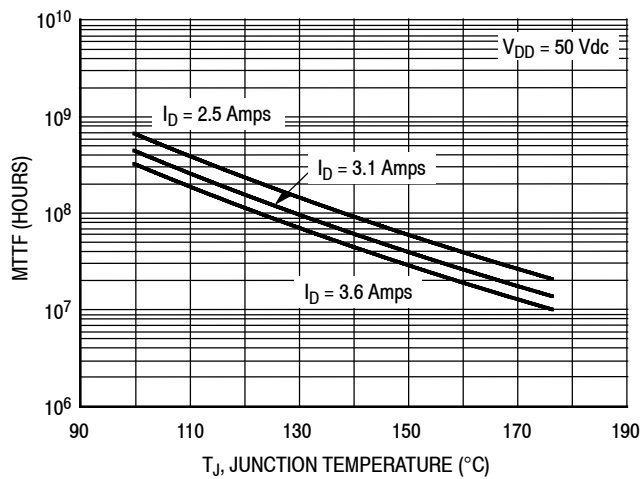


Figure 1. Capacitance versus Drain-Source Voltage



**Note:** MTTF value represents the total cumulative operating time under indicated test conditions.

MTTF calculator available at <http://www.nxp.com/RF/calculators>.

Figure 2. MTTF versus Junction Temperature — CW

### 13.56 MHz COMPACT REFERENCE CIRCUIT (MRF101AN) — 0.7" × 2.0" (1.8 cm × 5.0 cm)

**Table 8. 13.56 MHz Performance** (In NXP Reference Circuit, 50 ohm system)

$V_{DD} = 50$  Vdc,  $I_{DQ} = 100$  mA,  $P_{in} = 0.25$  W, CW

Frequency (MHz)	$P_{out}$ (W)	$G_{ps}$ (dB)	$\eta_D$ (%)
13.56	130	27.1	79.6

### 13.56 MHz COMPACT REFERENCE CIRCUIT (MRF101AN) — 0.7" × 2.0" (1.8 cm × 5.0 cm)

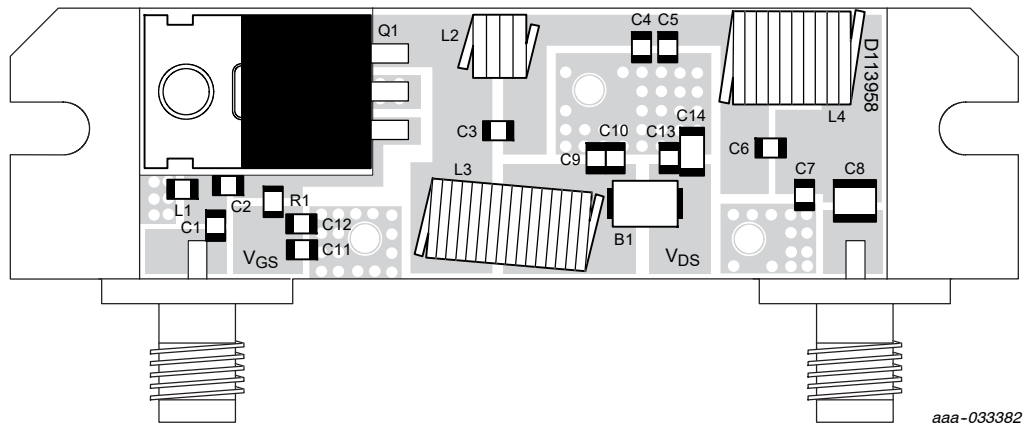


Figure 3. MRF101AN Compact Reference Circuit Component Layout and Assembly Example — 13.56 MHz

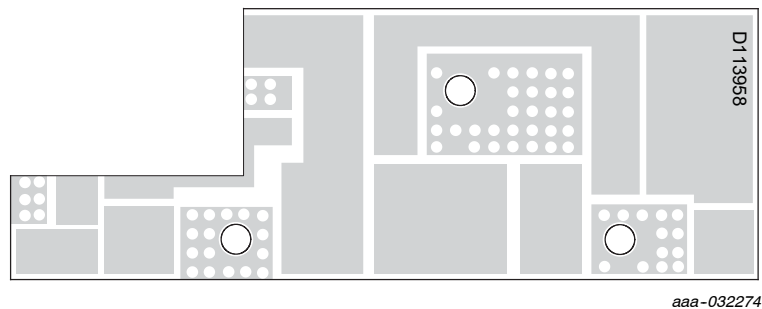
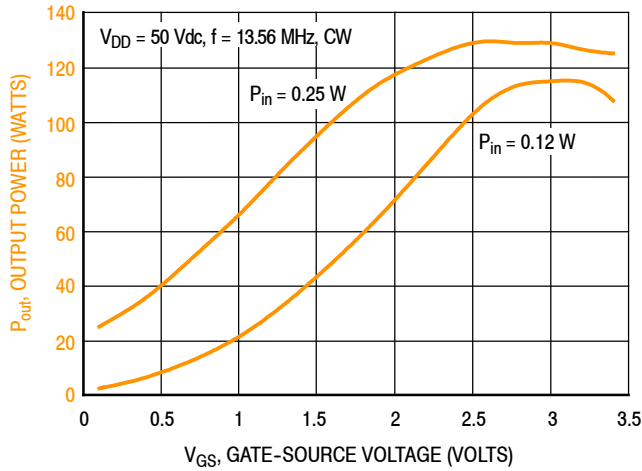


Figure 4. MRF101AN Compact Reference Circuit Board

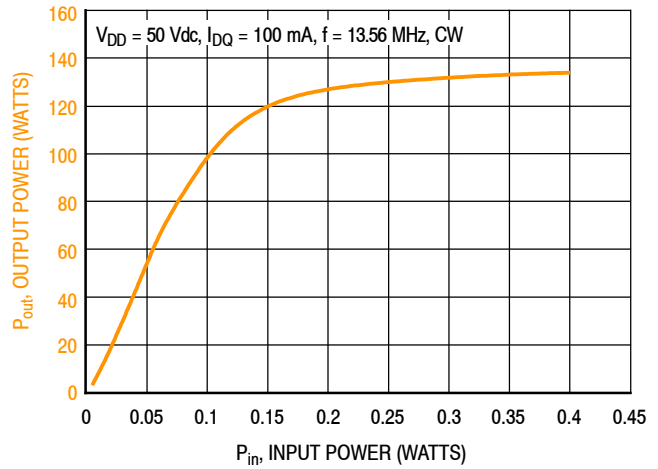
Table 9. MRF101AN Compact Reference Circuit Component Designations and Values — 13.56 MHz

Part	Description	Part Number	Manufacturer
B1	Short RF Bead	2743019447	Fair-Rite
C1, C2, C9, C10, C12, C13	0.01 $\mu$ F Chip Capacitor	GRM21BR72A103KA01B	Murata
C3	33 pF Chip Capacitor	GQM2195C2E330GB12D	Murata
C4	360 pF Chip Capacitor	GRM2165C2A361JA01D	Murata
C5	390 pF Chip Capacitor	GRM2165C2A391JA01D	Murata
C6	68 pF Chip Capacitor	GQM2195C2E680GB12D	Murata
C7	200 pF Chip Capacitor	GQM2195C2A201GB12D	Murata
C8	0.01 $\mu$ F Chip Capacitor	200B103KT50XT	ATC
C11	1 $\mu$ F Chip Capacitor	GRM21BR71H105KA12L	Murata
C14	1 $\mu$ F Chip Capacitor	C3216X7R2A105K160AA	TDK
L1	820 nH Chip Inductor	0805WL821JT	ATC
L2	4 Turn, #20 AWG, ID = 0.2" Inductor, Hand Wound	8076	Belden
L3	500 nH Square Air Core Inductor	2929SQ-501JE	Coilcraft
L4	330 nH Square Air Core Inductor	2929SQ-331JE	Coilcraft
Q1	RF Power LD MOS Transistor	MRF101AN	NXP
R1	75 $\Omega$ , 1/4 W Chip Resistor	SG73P2ATTD75R0F	KOA Speer
PCB	FR4 0.09", $\epsilon_r = 4.8$ , 2 oz. Copper	D113958	MTL

**TYPICAL CHARACTERISTICS — 13.56 MHz  
COMPACT REFERENCE CIRCUIT (MRF101AN)**

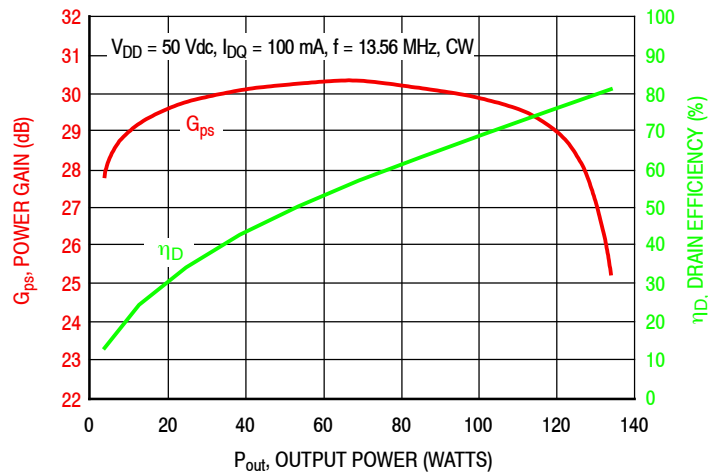


**Figure 5. CW Output Power versus Gate-Source Voltage at a Constant Input Power**



f (MHz)	P1dB (W)	P3dB (W)
13.56	113	128

**Figure 6. CW Output Power versus Input Power**



**Figure 7. Power Gain and Drain Efficiency versus CW Output Power**

### 13.56 MHz COMPACT REFERENCE CIRCUIT (MRF101AN)

f (MHz)	Z <sub>source</sub> (Ω)	Z <sub>load</sub> (Ω)
13.56	25.3 + j10.2	11.3 - j6.4

Z<sub>source</sub> = Test circuit impedance as measured from gate to ground.

Z<sub>load</sub> = Test circuit impedance as measured from drain to ground.

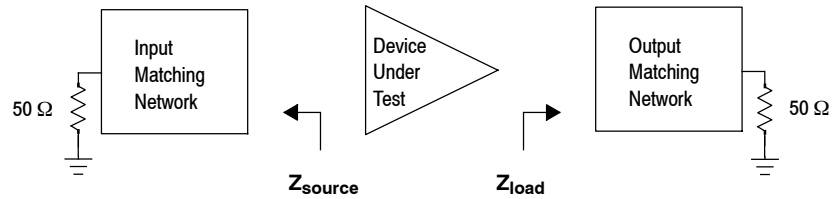


Figure 8. Series Equivalent Source and Load Impedance — 13.56 MHz



## 27 MHz COMPACT REFERENCE CIRCUIT (MRF101AN) — 0.7" × 2.0" (1.8 cm × 5.0 cm)

**Table 10. 27 MHz Performance** (In NXP Reference Circuit, 50 ohm system)

$V_{DD} = 50$  Vdc,  $I_{DQ} = 100$  mA,  $P_{in} = 0.4$  W, CW

Frequency (MHz)	$P_{out}$ (W)	$G_{ps}$ (dB)	$\eta_D$ (%)
27	125	24.9	79.6

## 27 MHz COMPACT REFERENCE CIRCUIT (MRF101AN) — 0.7" x 2.0" (1.8 cm x 5.0 cm)

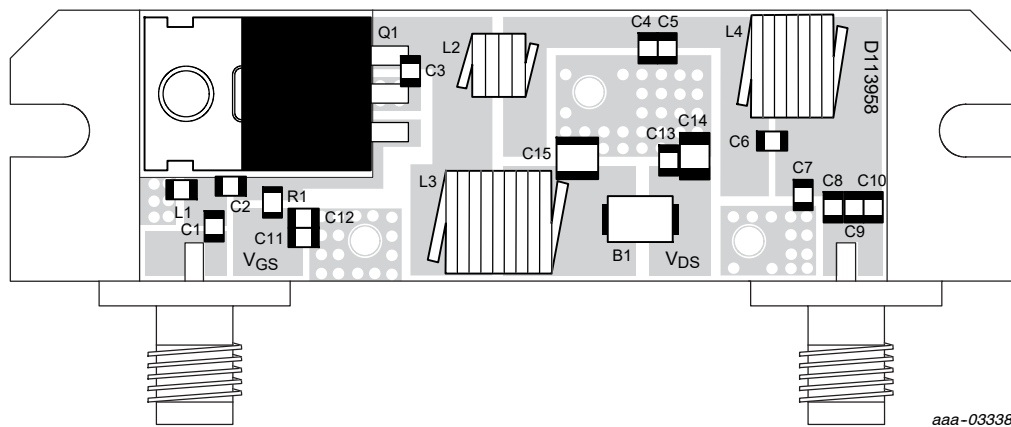


Figure 9. MRF101AN Compact Reference Circuit Component Layout and Assembly Example — 27 MHz

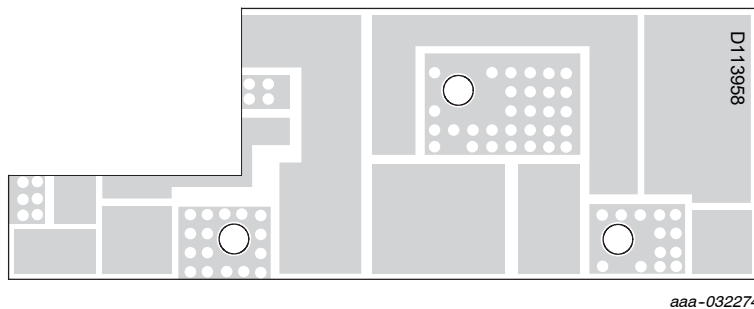


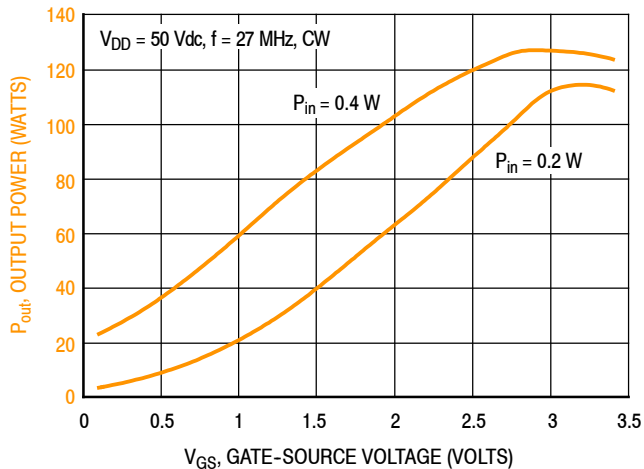
Figure 10. MRF101AN Compact Reference Circuit Board

Table 11. MRF101AN Compact Reference Circuit Component Designations and Values — 27 MHz

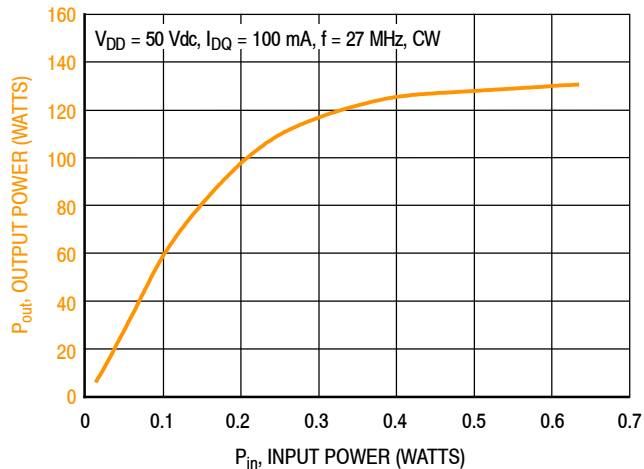
Part	Description	Part Number	Manufacturer
B1	Short RF Bead	2743019447	Fair-Rite
C1	82 pF Chip Capacitor	GQM2195C2E820GB12D	Murata
C2	200 pF Chip Capacitor	GQM2195C2A201GB12D	Murata
C3	33 pF Chip Capacitor	GQM2195C2E330GB12D	Murata
C4, C5	160 pF Chip Capacitor	GQM2195C2A161JB12D	Murata
C6	15 pF Chip Capacitor	GQM2195C2E150FB12D	Murata
C7	100 pF Chip Capacitor	GQM2195C2E101GB12D	Murata
C8, C9, C10	1000 pF Chip Capacitor	GRM2165C2A102JA01D	Murata
C11	1 $\mu$ F Chip Capacitor	08055C105KAT2A	AVX
C12, C13	0.01 $\mu$ F Chip Capacitor	GRM21BR72A103KA01B	Murata
C14	1 $\mu$ F Chip Capacitor	CL31B105KCHSNNE	Samsung
C15	6.8 nF Chip Capacitor	GRM32QR73A682KW	Murata
L1	270 nH Chip Inductor	0805WL221JT	ATC
L2	39 nH Chip Inductor	1812SMS-39NJLC	Coilcraft
L3	300 nH Square Air Core Inductor	2222SQ-301JE	Coilcraft
L4	180 nH Square Air Core Inductor	2222SQ-181JE	Coilcraft
Q1	RF Power LD MOS Transistor	MRF101AN	NXP
R1	75 $\Omega$ , 1/4 W Chip Resistor	SG73P2ATTD75R0F	KOA Speer
PCB	FR4 0.09", $\epsilon_r = 4.8$ , 2 oz. Copper	D113958	MTL

MRF101AN MRF101BN

**TYPICAL CHARACTERISTICS — 27 MHz  
COMPACT REFERENCE CIRCUIT (MRF101AN)**

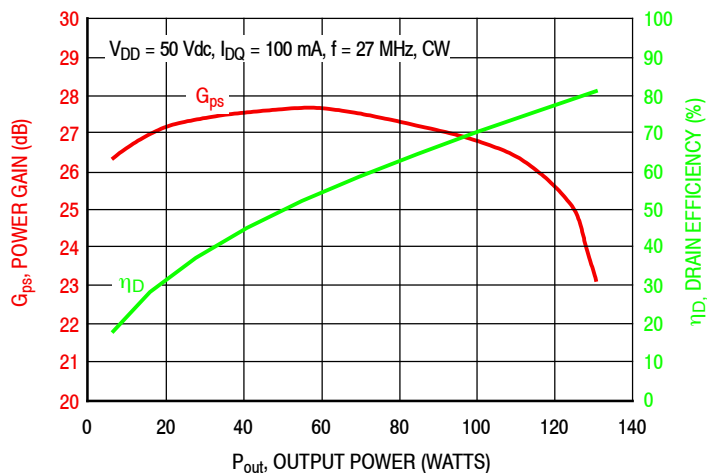


**Figure 11. CW Output Power versus Gate-Source Voltage at a Constant Input Power**



f (MHz)	P1dB (W)	P3dB (W)
27	103	125

**Figure 12. CW Output Power versus Input Power**



**Figure 13. Power Gain and Drain Efficiency versus CW Output Power**

## 27 MHz COMPACT REFERENCE CIRCUIT (MRF101AN)

f (MHz)	Z <sub>source</sub> (Ω)	Z <sub>load</sub> (Ω)
27	28.9 + j14.7	12.9 - j5.3

Z<sub>source</sub> = Test circuit impedance as measured from gate to ground.

Z<sub>load</sub> = Test circuit impedance as measured from drain to ground.

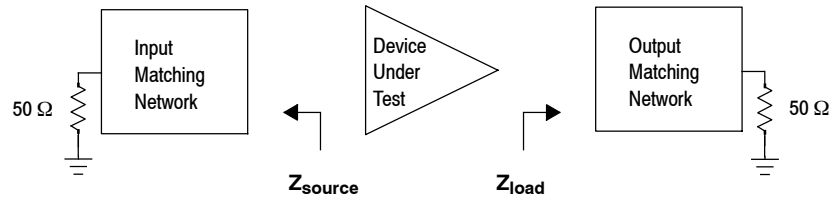


Figure 14. Series Equivalent Source and Load Impedance — 27 MHz

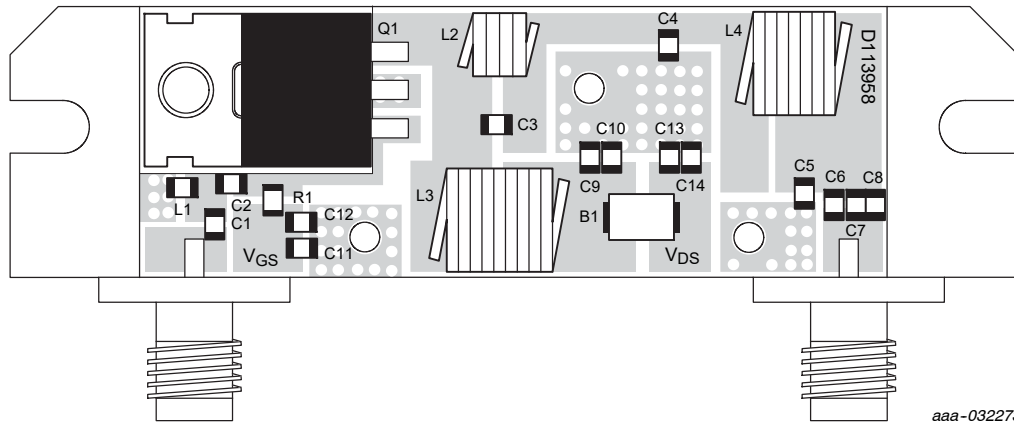
## 40.68 MHz COMPACT REFERENCE CIRCUIT (MRF101AN) — 0.7" × 2.0" (1.8 cm × 5.0 cm)

**Table 12. 40.68 MHz Performance** (In NXP Reference Circuit, 50 ohm system)

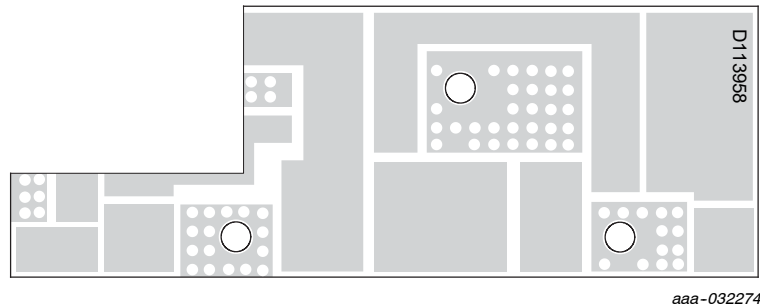
$V_{DD} = 50$  Vdc,  $I_{DQ} = 100$  mA,  $P_{in} = 0.5$  W, CW

Frequency (MHz)	$P_{out}$ (W)	$G_{ps}$ (dB)	$\eta_D$ (%)
40.68	120	23.8	81.5

**40.68 MHz COMPACT REFERENCE CIRCUIT (MRF101AN) — 0.7" × 2.0" (1.8 cm × 5.0 cm)**



**Figure 15. MRF101AN Compact Reference Circuit Component Layout and Assembly Example — 40.68 MHz**

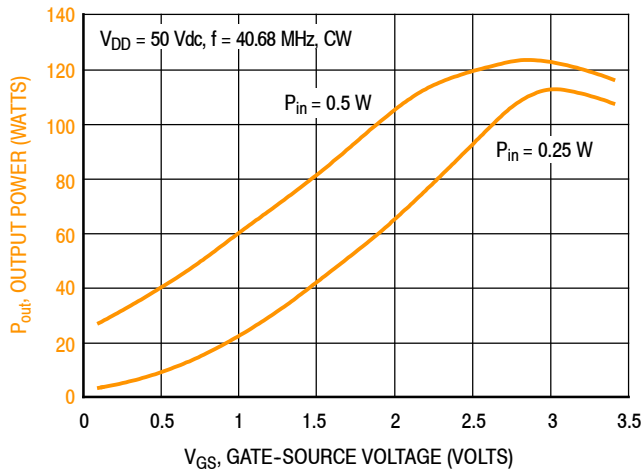


**Figure 16. MRF101AN Compact Reference Circuit Board**

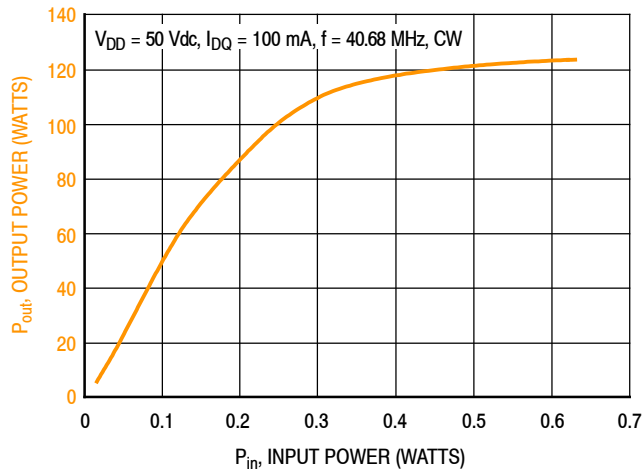
**Table 13. MRF101AN Compact Reference Circuit Component Designations and Values — 40.68 MHz**

Part	Description	Part Number	Manufacturer
B1	Short RF Bead	2743019447	Fair-Rite
C1, C5	82 pF Chip Capacitor	GQM2195C2E820GB12D	Murata
C2, C4	200 pF Chip Capacitor	GQM2195C2A201GB12D	Murata
C3	33 pF Chip Capacitor	GQM2195C2E330GB12D	Murata
C6, C7, C8, C9, C10	1000 pF Chip Capacitor	GRM2165C2A102JA01D	Murata
C11	1 $\mu$ F Chip Capacitor	GJ821BR71H105KA12L	Murata
C12, C13	0.01 $\mu$ F Chip Capacitor	GRM21BR72A103KA01B	Murata
C14	1 $\mu$ F Chip Capacitor	C3216X7R2A105K160AA	TDK
L1	150 nH Chip Inductor	0805WL151JT	ATC
L2	17.5 nH, 4 Turn Inductor	GA3095-ACL	Coilcraft
L3	160 nH Square Air Core Inductor	2222SQ-161JEC	Coilcraft
L4	110 nH Square Air Core Inductor	2222SQ-111JEB	Coilcraft
Q1	RF Power LD MOS Transistor	MRF101AN	NXP
R1	75 $\Omega$ , 1/4 W Chip Resistor	SG73P2ATTD75R0F	KOA Speer
PCB	FR4 0.09", $\epsilon_r = 4.8$ , 2 oz. Copper	D113958	MTL

**TYPICAL CHARACTERISTICS — 40.68 MHz  
COMPACT REFERENCE CIRCUIT (MRF101AN)**

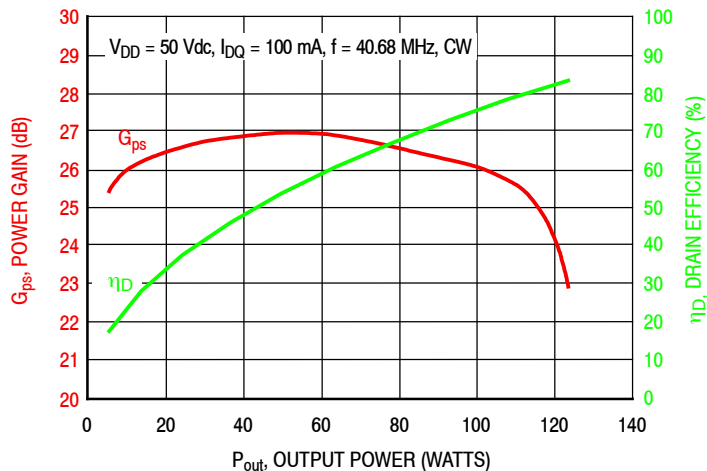


**Figure 17. CW Output Power versus Gate-Source Voltage at a Constant Input Power**



f (MHz)	P1dB (W)	P3dB (W)
40.68	101	121

**Figure 18. CW Output Power versus Input Power**



**Figure 19. Power Gain and Drain Efficiency versus CW Output Power**

## 40.68 MHz COMPACT REFERENCE CIRCUIT (MRF101AN)

f (MHz)	Z <sub>source</sub> (Ω)	Z <sub>load</sub> (Ω)
40.68	24.0 + j12.6	14.2 - j2.5

Z<sub>source</sub> = Test circuit impedance as measured from gate to ground.

Z<sub>load</sub> = Test circuit impedance as measured from drain to ground.

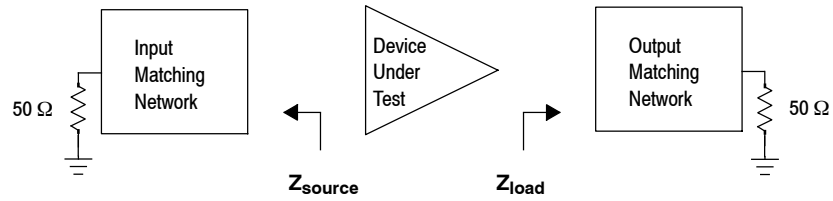


Figure 20. Series Equivalent Source and Load Impedance — 40.68 MHz



## 50 MHz COMPACT REFERENCE CIRCUIT (MRF101AN) — 0.7" × 2.0" (1.8 cm × 5.0 cm)

**Table 14. 50 MHz Performance** (In NXP Reference Circuit, 50 ohm system)

$V_{DD} = 50$  Vdc,  $I_{DQ} = 100$  mA,  $P_{in} = 0.64$  W, CW

Frequency (MHz)	$P_{out}$ (W)	$G_{ps}$ (dB)	$\eta_D$ (%)
50	119	22.8	82.1

## 50 MHz COMPACT REFERENCE CIRCUIT (MRF101AN) — 0.7" x 2.0" (1.8 cm x 5.0 cm)

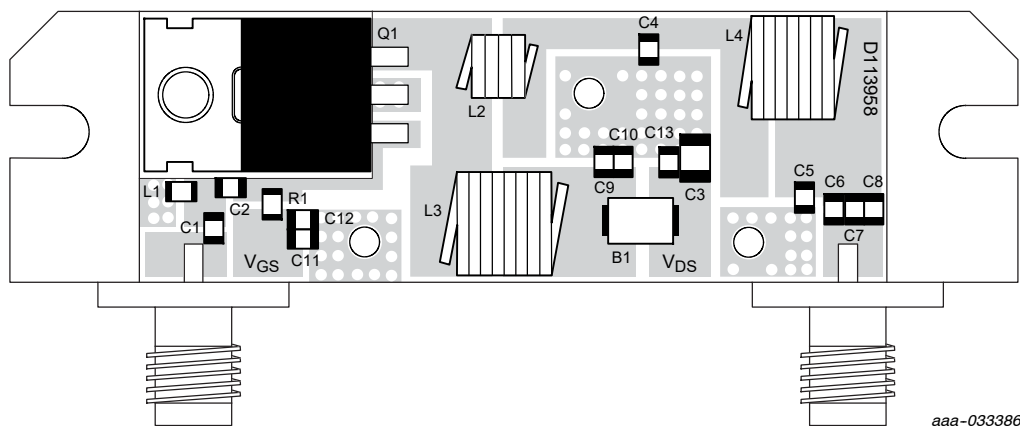


Figure 21. MRF101AN Compact Reference Circuit Component Layout and Assembly Example — 50 MHz

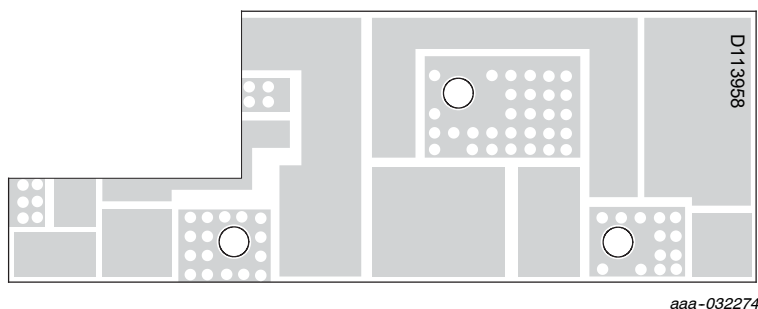
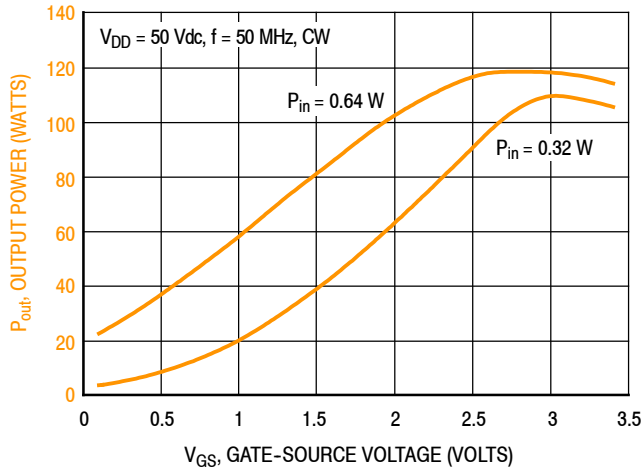


Figure 22. MRF101AN Compact Reference Circuit Board

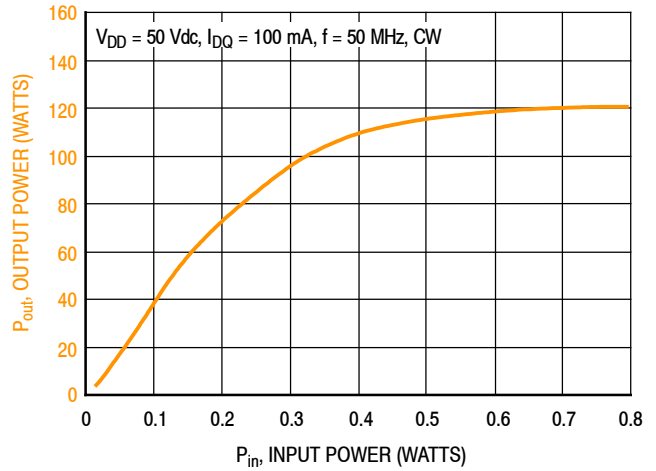
Table 15. MRF101AN Compact Reference Circuit Component Designations and Values — 50 MHz

Part	Description	Part Number	Manufacturer
B1	Short RF Bead	2743019447	Fair-Rite
C1	82 pF Chip Capacitor	GQM2195C2E820GB12D	Murata
C2	200 pF Chip Capacitor	GQM2195C2A201GB12D	Murata
C3	1 $\mu$ F Chip Capacitor	CL31B105KCHSNNE	Samsung
C4	180 pF Chip Capacitor	GQM2195C2A181GB12D	Murata
C5	68 pF Chip Capacitor	GQM2195C2E680GB12D	Murata
C6, C7, C8, C9, C10	1000 pF Chip Capacitor	GRM2165C2A102JA01D	Murata
C11	1 $\mu$ F Chip Capacitor	08055C105KAT2A	AVX
C12, C13	0.01 $\mu$ F Chip Capacitor	GRM21BR72A103KA01B	Murata
L1	100 nH Chip Inductor	0805WL101JT	ATC
L2	17.5 nH Air Core Inductor	GA3095-ALC	Coilcraft
L3	160 nH Square Air Core Inductor	2222SQ-161JEC	Coilcraft
L4	110 nH Square Air Core Inductor	2222SQ-111JEB	Coilcraft
Q1	RF Power LD MOS Transistor	MRF101AN	NXP
R1	75 $\Omega$ , 1/4 W Chip Resistor	SG73P2ATTD75R0F	KOA Speer
PCB	FR4 0.09", $\epsilon_r = 4.8$ , 2 oz. Copper	D113958	MTL

**TYPICAL CHARACTERISTICS — 50 MHz  
COMPACT REFERENCE CIRCUIT (MRF101AN)**

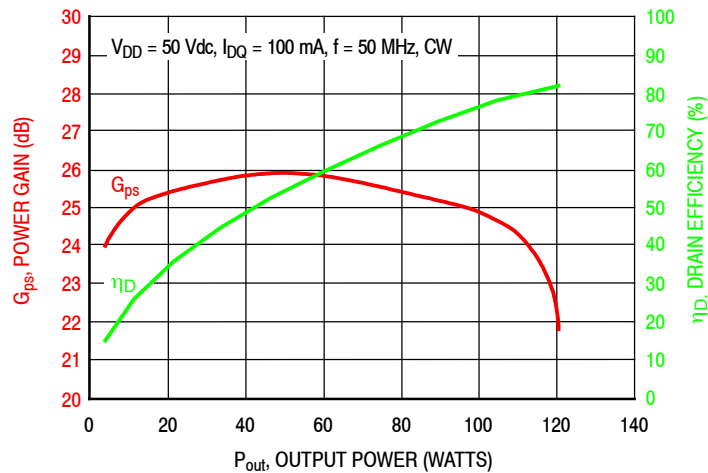


**Figure 23. CW Output Power versus Gate-Source Voltage at a Constant Input Power**



f (MHz)	P1dB (W)	P3dB (W)
50	99	118

**Figure 24. CW Output Power versus Input Power**



**Figure 25. Power Gain and Drain Efficiency versus CW Output Power**

## 50 MHz COMPACT REFERENCE CIRCUIT (MRF101AN)

f (MHz)	Z <sub>source</sub> (Ω)	Z <sub>load</sub> (Ω)
50	19.2 + j12.8	15.8 - j3.2

Z<sub>source</sub> = Test circuit impedance as measured from gate to ground.

Z<sub>load</sub> = Test circuit impedance as measured from drain to ground.

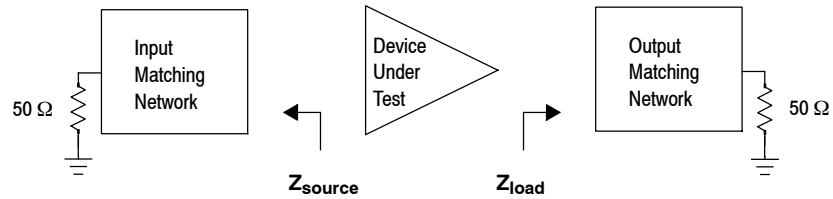


Figure 26. Series Equivalent Source and Load Impedance — 50 MHz

## 81.36 MHz REFERENCE CIRCUIT (MRF101AN) — 2.0" x 3.0" (5.0 cm x 7.6 cm)

**Table 16. 81.36 MHz Performance** (In NXP Reference Circuit, 50 ohm system)

$V_{DD} = 50$  Vdc,  $I_{DQ} = 100$  mA,  $P_{in} = 0.64$  W, CW

Frequency (MHz)	$P_{out}$ (W)	$G_{ps}$ (dB)	$\eta_D$ (%)
81.36	130	23.2	80.8

### 81.36 MHz REFERENCE CIRCUIT (MRF101AN) — 2.0" × 3.0" (5.0 cm × 7.6 cm)

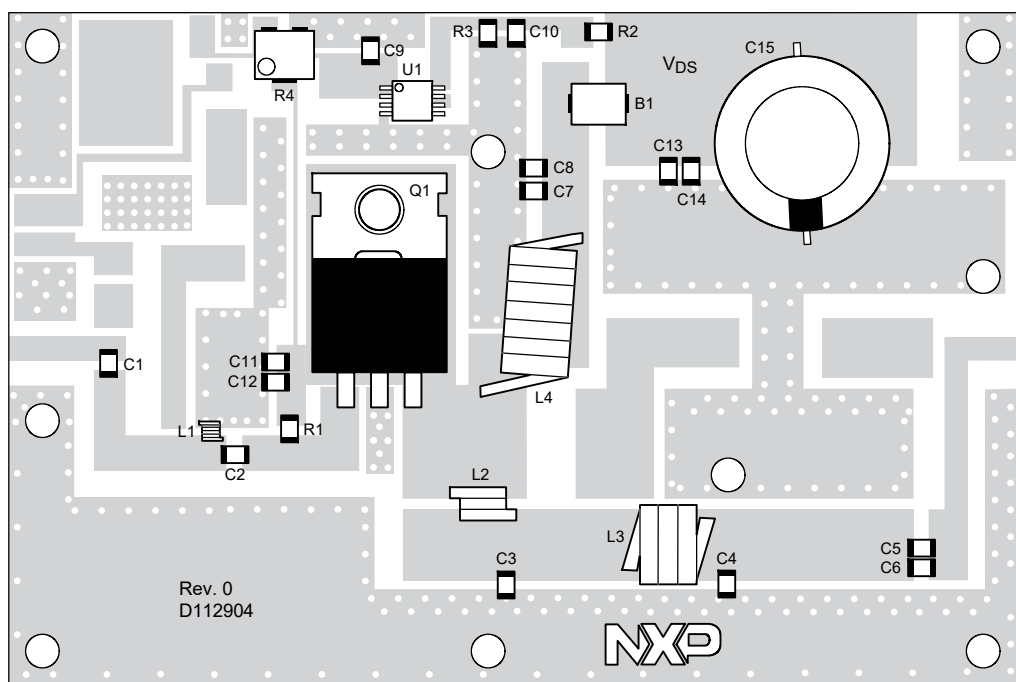
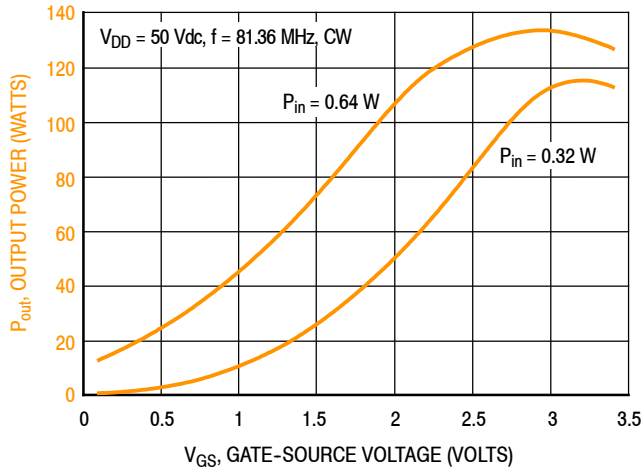


Figure 27. MRF101AN Reference Circuit Component Layout — 81.36 MHz

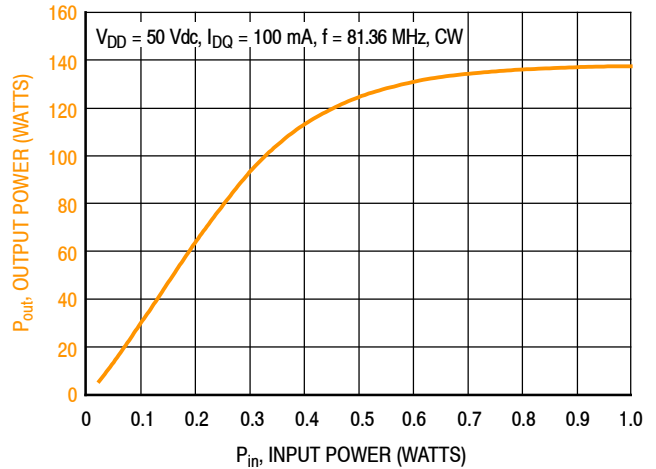
Table 17. MRF101AN Reference Circuit Component Designations and Values — 81.36 MHz

Part	Description	Part Number	Manufacturer
B1	Short RF Bead	2743019447	Fair-Rite
C1, C5, C6, C7, C8	1000 pF Chip Capacitor	GRM2165C2A102JA01D	Murata
C2	200 pF Chip Capacitor	GQM2195C2A201GB12D	Murata
C3	100 pF Chip Capacitor	GQM2195C2E101GB12D	Murata
C4	68 pF Chip Capacitor	GQM2195C2E680GB12D	Murata
C9, C10, C11, C14	1 $\mu$ F Chip Capacitor	GRM21BR71H105KA12L	Murata
C12, C13	0.01 $\mu$ F Chip Capacitor	GRM21BR72A103KA01B	Murata
C15	220 $\mu$ F, 100 V Electrolytic Capacitor	MCGPR100V227M16X26	Multicomp
L1	56 nH Chip Inductor	0805WL560JT	ATC
L2	6.6 nH Air Coil Inductor	GA3093-ALC	Coilcraft
L3	3 Turn, #18 AWG, ID = 0.225" Inductor	Handwound	NXP
L4	7 Turn, #18 AWG, ID = 0.225" Inductor	Handwound	NXP
Q1	RF Power LDMOS Transistor	MRF101AN	NXP
R1	75 $\Omega$ , 1/4 W Chip Resistor	SG73P2ATTD75R0F	KOA Speer
R2, R3	10 k $\Omega$ , 1/8 W Chip Resistor	CRCW080510K0FKEA	Vishay
R4	5 k $\Omega$ Multi-turn Cermet Trimming Potentiometer, 12 Turns	3224W-1-502E	Bourns
U1	Voltage Regulator 5 V, Micro8	LP2951ACDMR2G	ON Semiconductor
PCB	FR4 0.09", $\epsilon_r = 4.8$ , 2 oz. Copper	D112904	MTL

**TYPICAL CHARACTERISTICS — 81.36 MHz  
REFERENCE CIRCUIT (MRF101AN)**

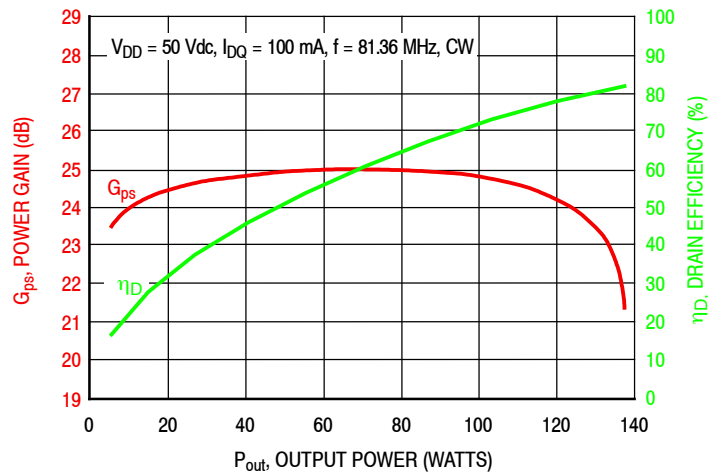


**Figure 28. CW Output Power versus Gate-Source Voltage at a Constant Input Power**



f (MHz)	P1dB (W)	P3dB (W)
81.36	123	136

**Figure 29. CW Output Power versus Input Power**



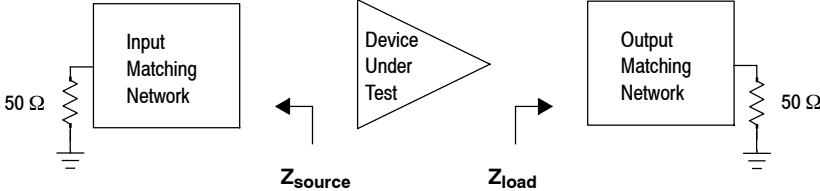
**Figure 30. Power Gain and Drain Efficiency versus CW Output Power**

**81.36 MHz REFERENCE CIRCUIT (MRF101AN)**

<b>f (MHz)</b>	<b>Z<sub>source</sub> (Ω)</b>	<b>Z<sub>load</sub> (Ω)</b>
81.36	12.0 + j11.0	11.5 + j3.0

Z<sub>source</sub> = Test circuit impedance as measured from gate to ground.

Z<sub>load</sub> = Test circuit impedance as measured from drain to ground.



**Figure 31. Series Equivalent Source and Load Impedance — 81.36 MHz**



## 87.5–108 MHz COMPACT BROADBAND REFERENCE CIRCUIT (MRF101AN) — 0.7"× 2.0" (1.8 cm × 5.0 cm)

**Table 18. 87.5–108 MHz Broadband Performance** (In NXP Reference Circuit, 50 ohm system)

$V_{DD} = 50$  Vdc,  $I_{DQ} = 100$  mA,  $P_{in} = 1$  W, CW

Frequency (MHz)	$P_{out}$ (W)	$G_{ps}$ (dB)	$\eta_D$ (%)
87.5	122	20.8	79.0
98	115	20.6	76.8
108	115	20.6	76.0

87.5–108 MHz COMPACT BROADBAND REFERENCE CIRCUIT (MRF101AN) — 0.7" × 2.0" (1.8 cm × 5.0 cm)

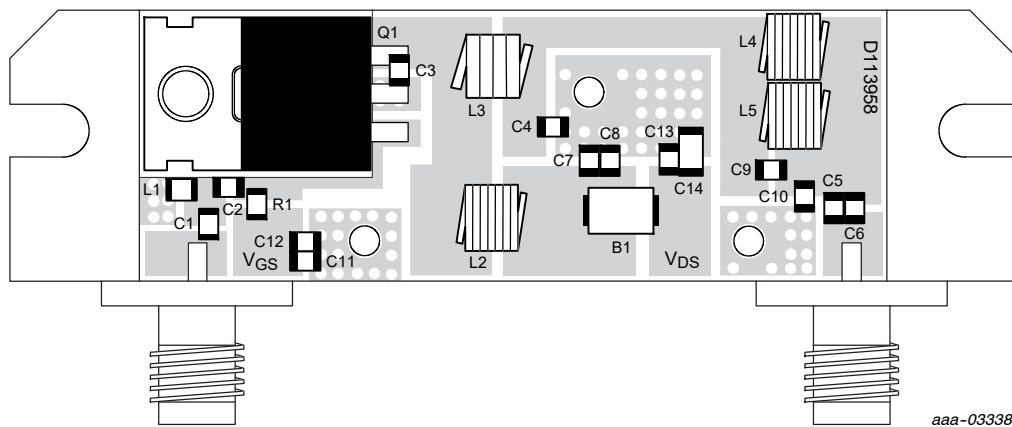


Figure 32. MRF101AN Compact Reference Circuit Component Layout and Assembly Example — 87.5–108 MHz

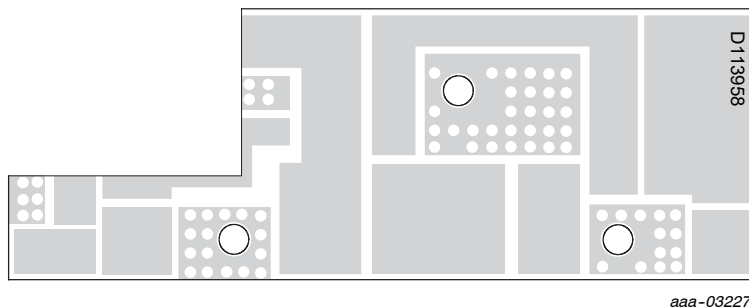
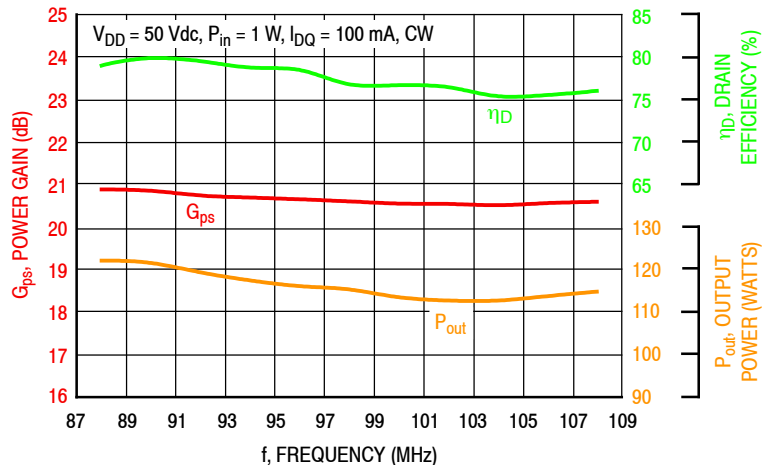


Figure 33. MRF101AN Compact Reference Circuit Board

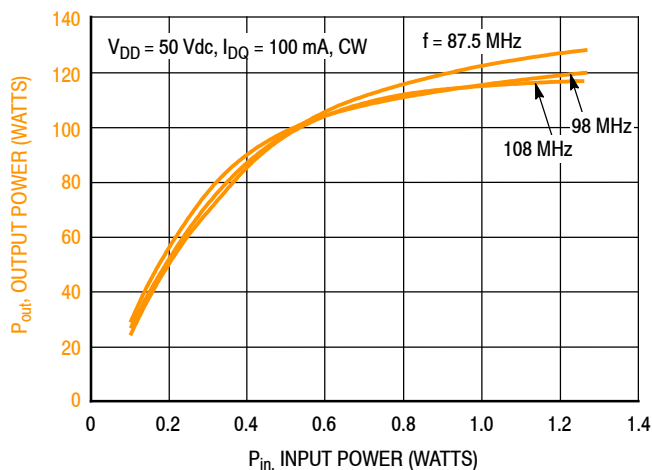
Table 19. MRF101AN Compact Reference Circuit Component Designations and Values — 87.5–108 MHz

Part	Description	Part Number	Manufacturer
B1	Short RF Bead	2743019447	Fair-Rite
C1, C2	200 pF Chip Capacitor	GQM2195C2A201GB12D	Murata
C3	22 pF Chip Capacitor	GQM2195C2E220GB12D	Murata
C4	100 pF Chip Capacitor	GQM2195C2E101GB12D	Murata
C5, C6, C7, C8, C12	510 pF Chip Capacitor	GRM2165C2A511JA01D	Murata
C9	2.7 pF Chip Capacitor	GQM2195C2E2R7BB12D	Murata
C10	36 pF Chip Capacitor	600F360JT250XT	ATC
C11	1 $\mu$ F Chip Capacitor	GJ821BR71H105KA12L	Murata
C13	0.01 $\mu$ F Chip Capacitor	GRM21BR72A103KA01B	Murata
C14	1 $\mu$ F Chip Capacitor	C3216X7R2A105K160AA	TDK
L1	36 nH Chip Inductor	0805WL360JT	ATC
L2, L4, L5	120 nH Chip Inductor	1812SMS-R12JLC	Coilcraft
L3	33 nH Chip Inductor	1812SMS-33NJLC	Coilcraft
Q1	RF Power LD MOS Transistor	MRF101AN	NXP
R1	75 $\Omega$ , 1/4 W Chip Resistor	SG73P2ATTD75R0F	KOA Speer
PCB	FR4 0.09", $\epsilon_r = 4.8$ , 2 oz. Copper	D113958	MTL

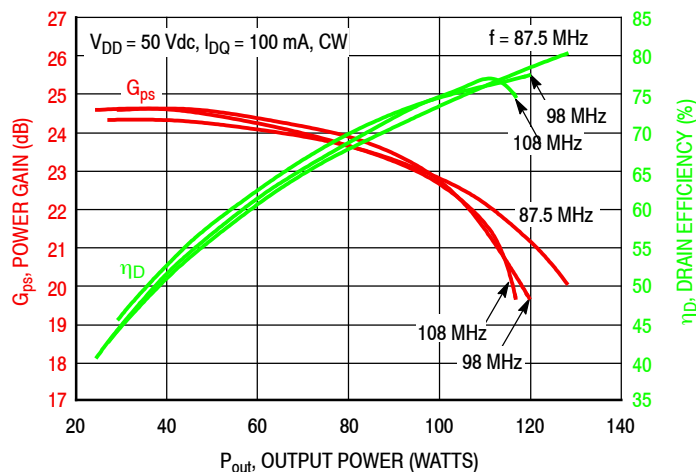
**TYPICAL CHARACTERISTICS — 87.5–108 MHz  
COMPACT BROADBAND REFERENCE CIRCUIT (MRF101AN)**



**Figure 34. Power Gain, Drain Efficiency and CW Output Power versus Frequency at a Constant Input Power**



**Figure 35. CW Output Power versus Input Power and Frequency**



**Figure 36. Power Gain and Drain Efficiency versus CW Output Power and Frequency**

## 87.5–108 MHz COMPACT BROADBAND REFERENCE CIRCUIT (MRF101AN)

f (MHz)	Z <sub>source</sub> (Ω)	Z <sub>load</sub> (Ω)
87.5	8.52 + j12.46	13.15 + j5.48
98	10.59 + j14.03	13.12 + j5.21
108	12.21 + j15.02	10.74 + j5.52

Z<sub>source</sub> = Test circuit impedance as measured from gate to ground.

Z<sub>load</sub> = Test circuit impedance as measured from drain to ground.

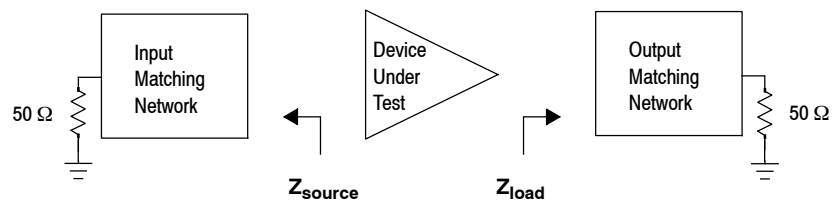
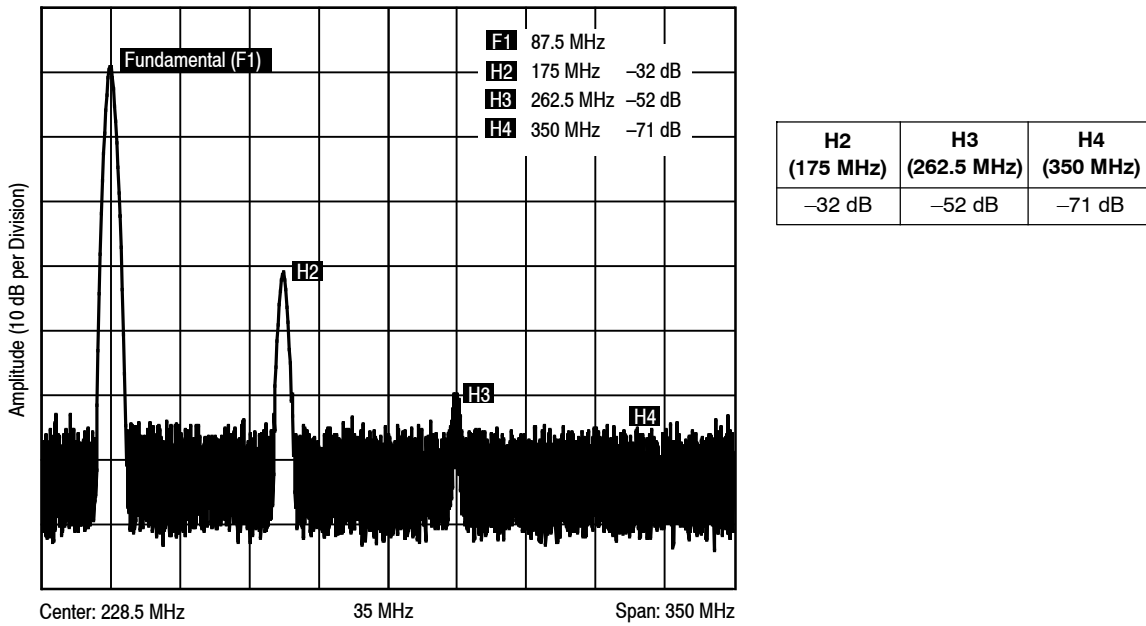


Figure 37. Series Equivalent Source and Load Impedance — 87.5–108 MHz

**HARMONIC MEASUREMENTS — 87.5–108 MHz  
COMPACT BROADBAND REFERENCE CIRCUIT**



**Figure 38. 87.5 MHz Harmonics @ 120 W CW**

## 136–174 MHz COMPACT VHF BROADBAND REFERENCE CIRCUIT (MRF101AN) — 0.7" x 2.0" (1.8 cm x 5.0 cm)

**Table 20. 136–174 MHz VHF Broadband Performance** (In NXP Reference Circuit, 50 ohm system)

$V_{DD} = 50$  Vdc,  $I_{DQ} = 100$  mA,  $P_{in} = 0.79$  W, CW

Frequency (MHz)	$P_{out}$ (W)	$G_{ps}$ (dB)	$\eta_D$ (%)
135	117	21.7	80.0
155	104	21.2	76.5
175	107	21.3	75.4

136–174 MHz COMPACT VHF BROADBAND REFERENCE CIRCUIT (MRF101AN) — 0.7" x 2.0" (1.8 cm x 5.0 cm)

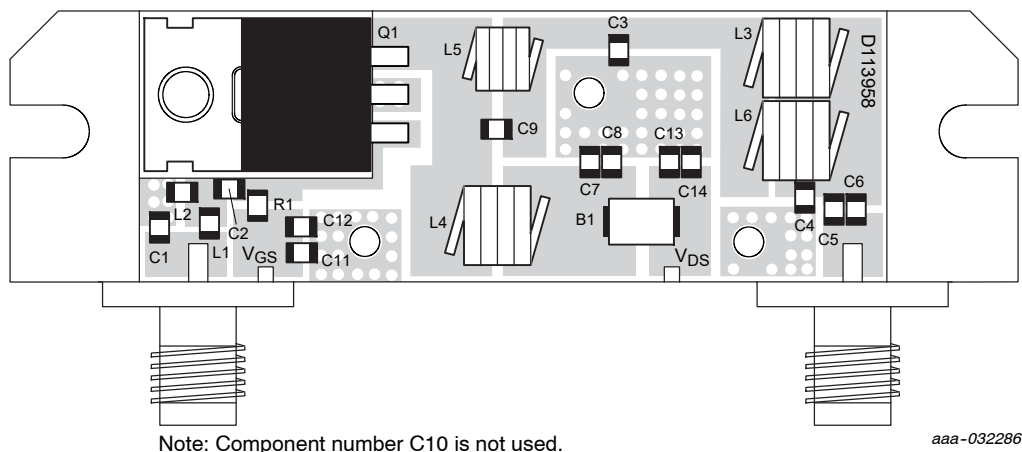


Figure 39. MRF101AN Compact Reference Circuit Component Layout and Assembly Example — 136–174 MHz

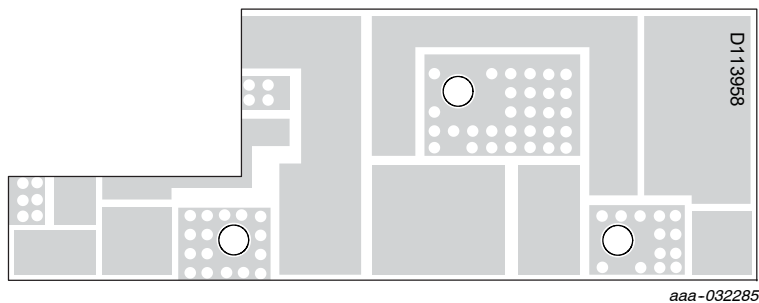
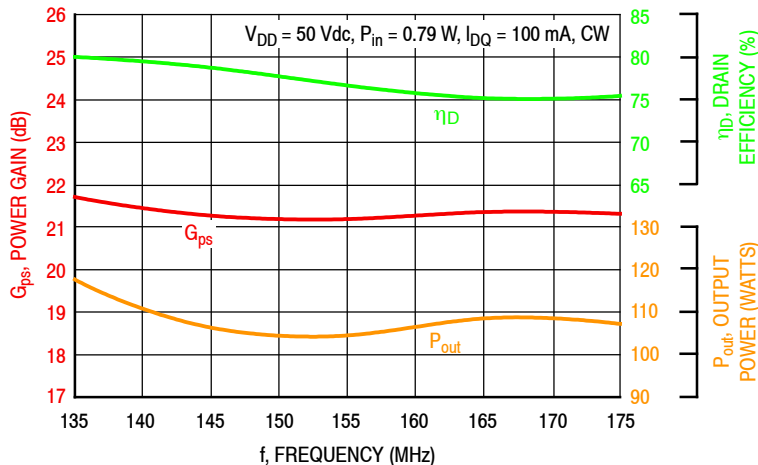


Figure 40. MRF101AN Compact Reference Circuit Board

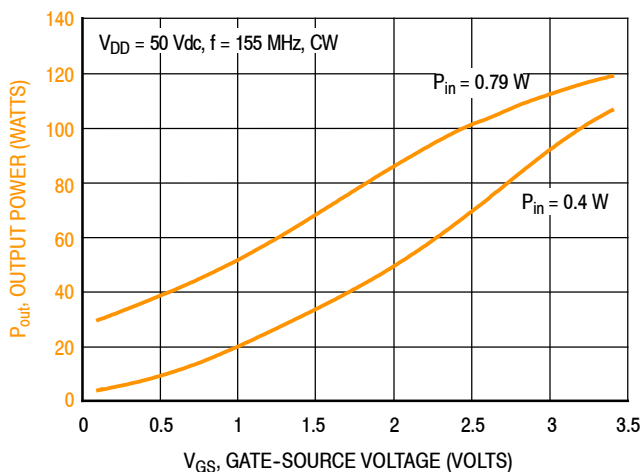
Table 21. MRF101AN Compact VHF Broadband Reference Circuit Component Designations and Values — 136–174 MHz

Part	Description	Part Number	Manufacturer
B1	Short RF Bead	2743019447	Fair-Rite
C1	39 pF Chip Capacitor	GQM2195C2E390GB12D	Murata
C2, C5, C6, C7, C8, C12	510 pF Chip Capacitor	GRM2165C2A511JA01D	Murata
C3	68 pF Chip Capacitor	GQM2195C2E680GB12D	Murata
C4	27 pF Chip Capacitor	GQM2195C2E270GB12D	Murata
C9	10 pF Chip Capacitor	GQM2195C2E100FB12D	Murata
C11	1 μF Chip Capacitor	GJ821BR71H105KA12L	Murata
C13	0.01 μF Chip Capacitor	GRM21BR72A103KA01B	Murata
C14	1 μF Chip Capacitor	C3216X7R2A105K160AA	TDK
L1	22 nH Chip Inductor	0805WL220JT	ATC
L2	12 nH Chip Inductor	0805WL120JT	ATC
L3, L4, L6	68 nH Air Core Inductor	1812SMS-68NJLC	Coilcraft
L5	12 nH, 3 Turn Inductor	GA3094-ALC	Coilcraft
Q1	RF Power LDMOS Transistor	MRF101AN	NXP
R1	75 Ω, 1/4 W Chip Resistor	SG73P2ATTD75R0F	KOA Speer
PCB	FR4 0.09", ε <sub>r</sub> = 4.8, 2 oz. Copper	D113958	MTL

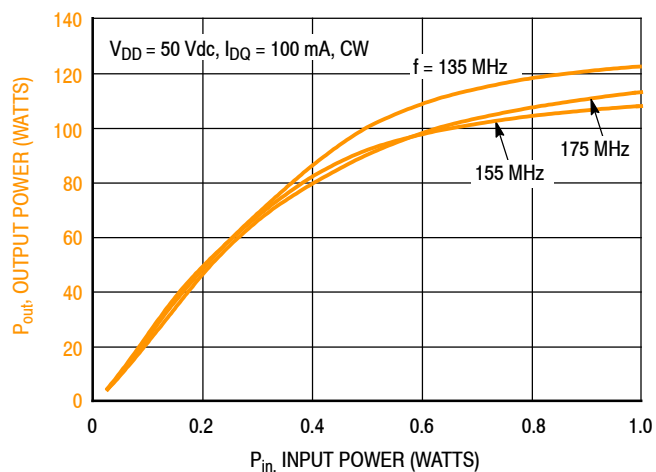
**TYPICAL CHARACTERISTICS — 136–174 MHz  
COMPACT VHF BROADBAND REFERENCE CIRCUIT (MRF101AN)**



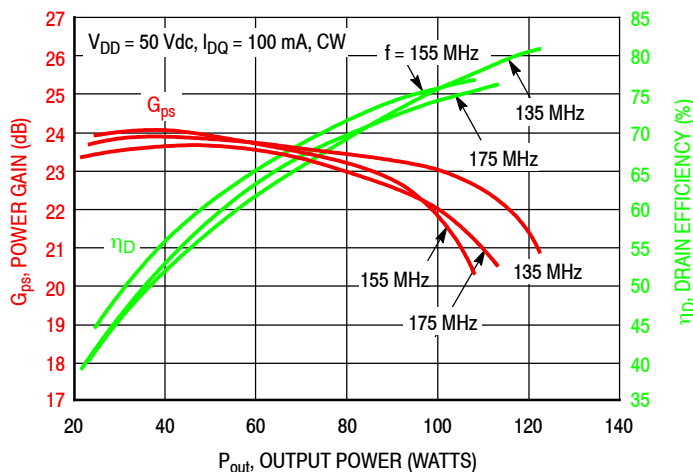
**Figure 41. Power Gain, Drain Efficiency and CW Output Power versus Frequency at a Constant Input Power**



**Figure 42. CW Output Power versus Gate-Source Voltage at a Constant Input Power**



**Figure 43. CW Output Power versus Input Power and Frequency**



**Figure 44. Power Gain and Drain Efficiency versus CW Output Power and Frequency**



## 136–174 MHz COMPACT VHF BROADBAND REFERENCE CIRCUIT (MRF101AN)

f (MHz)	Z <sub>source</sub> (Ω)	Z <sub>load</sub> (Ω)
135	6.8 + j10.2	9.5 + j5.2
145	6.2 + j10.2	9.9 + j5.9
155	5.3 + j10.8	10.2 + j6.2
165	4.4 + j11.9	10.0 + j5.9
175	3.9 + j13.4	8.8 + j5.0

Z<sub>source</sub> = Test circuit impedance as measured from gate to ground.

Z<sub>load</sub> = Test circuit impedance as measured from drain to ground.

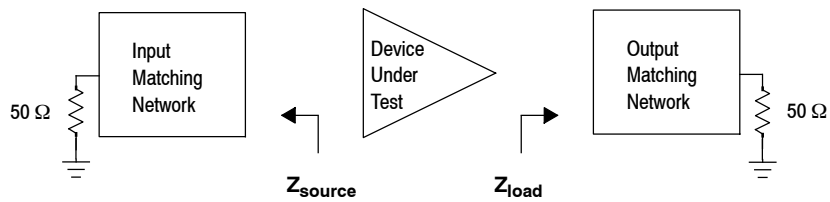
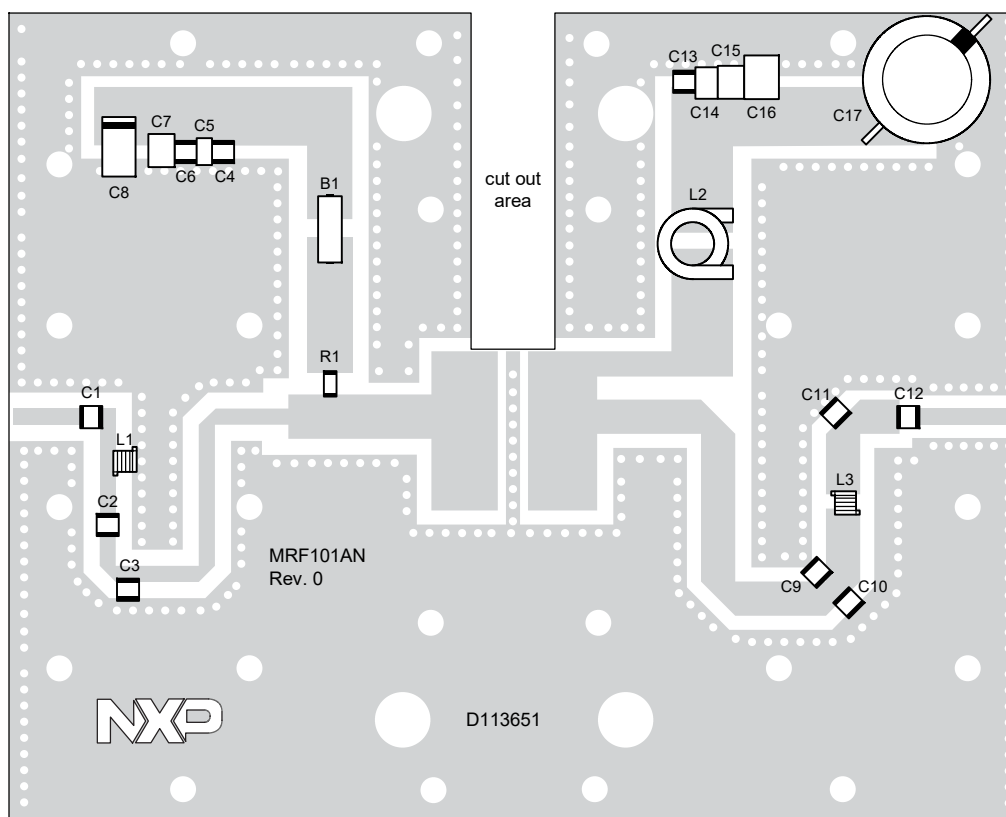


Figure 45. Series Equivalent Source and Load Impedance — 136–174 MHz

230 MHz FIXTURE (MRF101AN) — 4.0" x 5.0" (10.2 cm x 12.7 cm)



aaa-031939

Figure 46. MRF101AN Fixture Component Layout — 230 MHz

Table 22. MRF101AN Fixture Component Designations and Values — 230 MHz

Part	Description	Part Number	Manufacturer
B1	Long Ferrite Bead	2743021447	Fair-Rite
C1, C2, C10	18 pF Chip Capacitor	ATC100B180JT500XT	ATC
C3	43 pF Chip Capacitor	ATC100B430JT500XT	ATC
C4, C13	1000 pF Chip Capacitor	ATC800B102JT50XT	ATC
C5	0.1 $\mu$ F Chip Capacitor	GRM319R72A104KA01D	Murata
C6	10 nF Chip Capacitor	C1210C103J5GACTU	Kemet
C7	2.2 $\mu$ F Chip Capacitor	C3225X7R1H225K	TDK
C8	47 $\mu$ F, 16 V Tantalum Capacitor	T491D476K016AT	Kemet
C9	51 pF Chip Capacitor	ATC100B510JT500XT	ATC
C11	16 pF Chip Capacitor	ATC100B160JT500XT	ATC
C12	470 pF Chip Capacitor	ATC800B471JW50XT	ATC
C14	0.1 $\mu$ F Chip Capacitor	C1812104K1RACTU	Kemet
C15	2.2 $\mu$ F Chip Capacitor	C3225X7R2A225K	TDK
C16	2.2 $\mu$ F Chip Capacitor	HMK432B7225KM-T	Taiyo Yuden
C17	220 $\mu$ F, 100 V Electrolytic Capacitor	MCGPR100V227M16X26	Multicomp
L1	39 nH Chip Inductor	1812SMS-39NJLC	Coilcraft
L2	46 nH Chip Inductor	1010VS-46NME	Coilcraft
L3	17.5 nH, 4 Turn Inductor	GA3095-ALC	Coilcraft
R1	470 $\Omega$ , 1/4 W Chip Resistor	CRCW1206470RFKEA	Vishay
PCB	Rogers AD255C, 0.030", $\epsilon_r = 2.55$ , 2 oz. Copper	D113651	MTL

MRF101AN MRF101BN

TYPICAL CHARACTERISTICS — 230 MHz FIXTURE,  $T_C = 25^\circ\text{C}$  (MRF101AN)

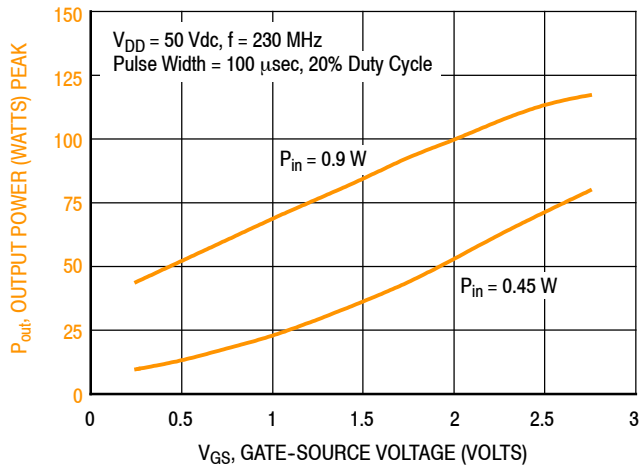
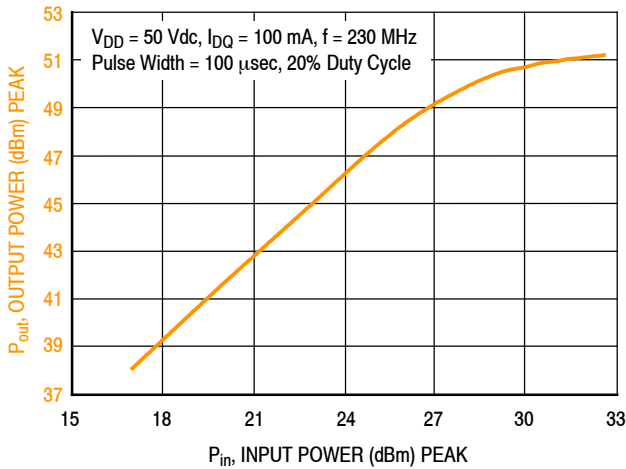


Figure 47. Output Power versus Gate-Source Voltage at a Constant Input Power



f (MHz)	P1dB (W)	P3dB (W)
230	110	128

Figure 48. Output Power versus Input Power

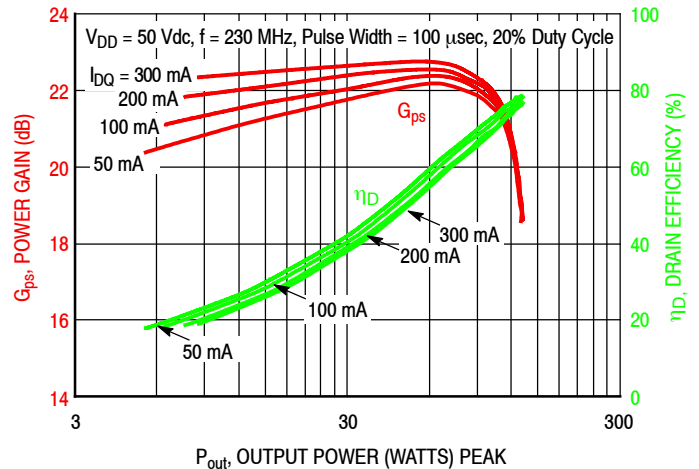


Figure 49. Power Gain and Drain Efficiency versus Output Power and Quiescent Current

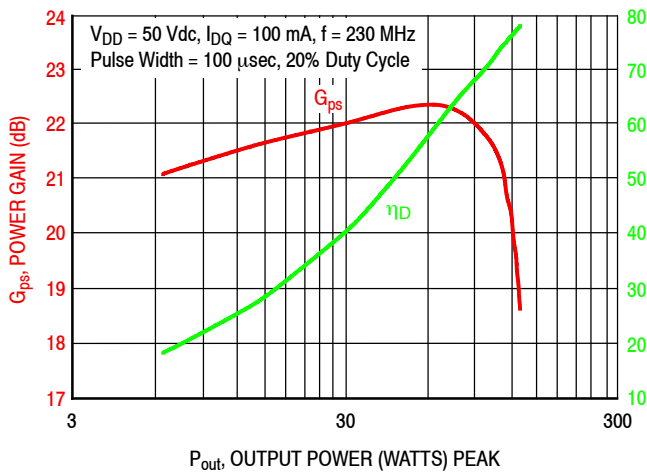


Figure 50. Power Gain and Drain Efficiency versus Output Power

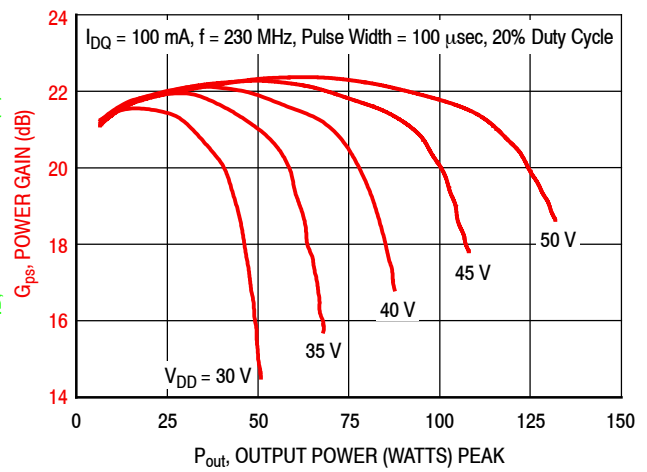


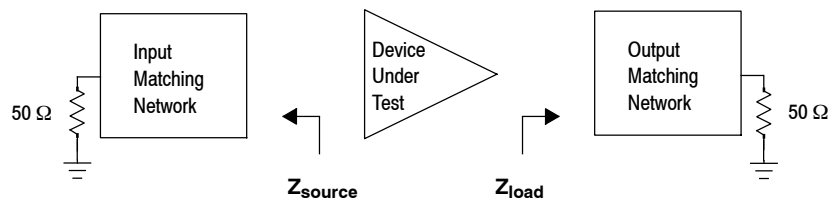
Figure 51. Power Gain versus Output Power and Drain-Source Voltage

## 230 MHz FIXTURE (MRF101AN)

<b>f (MHz)</b>	<b>Z<sub>source</sub> (Ω)</b>	<b>Z<sub>load</sub> (Ω)</b>
230	2.1 + j5.9	5.5 + j3.2

Z<sub>source</sub> = Test circuit impedance as measured from gate to ground.

Z<sub>load</sub> = Test circuit impedance as measured from drain to ground.

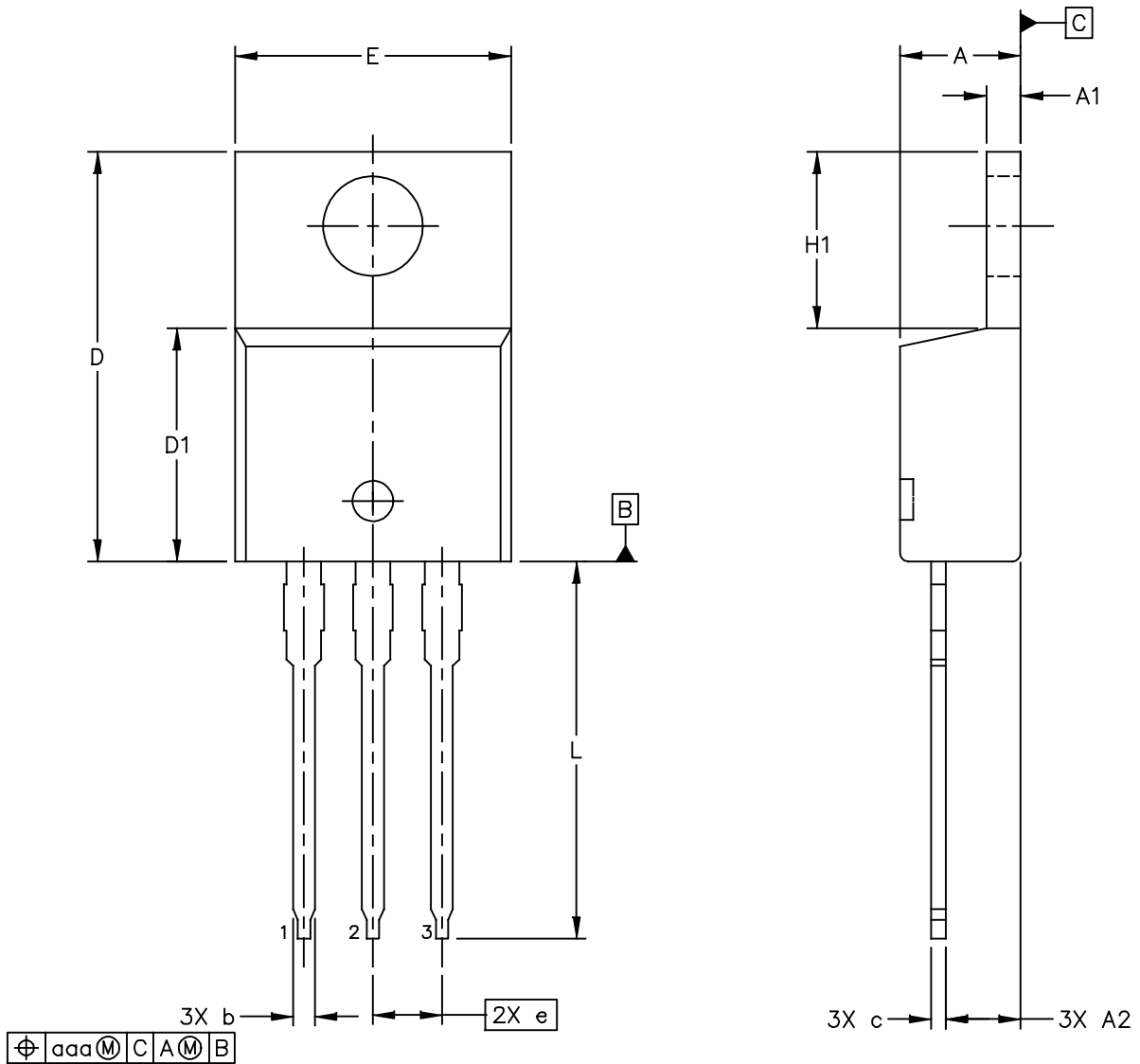


**Figure 52. Series Equivalent Source and Load Impedance — 230 MHz**

# PACKAGE DIMENSIONS

TO-220-3

SOT1937-1



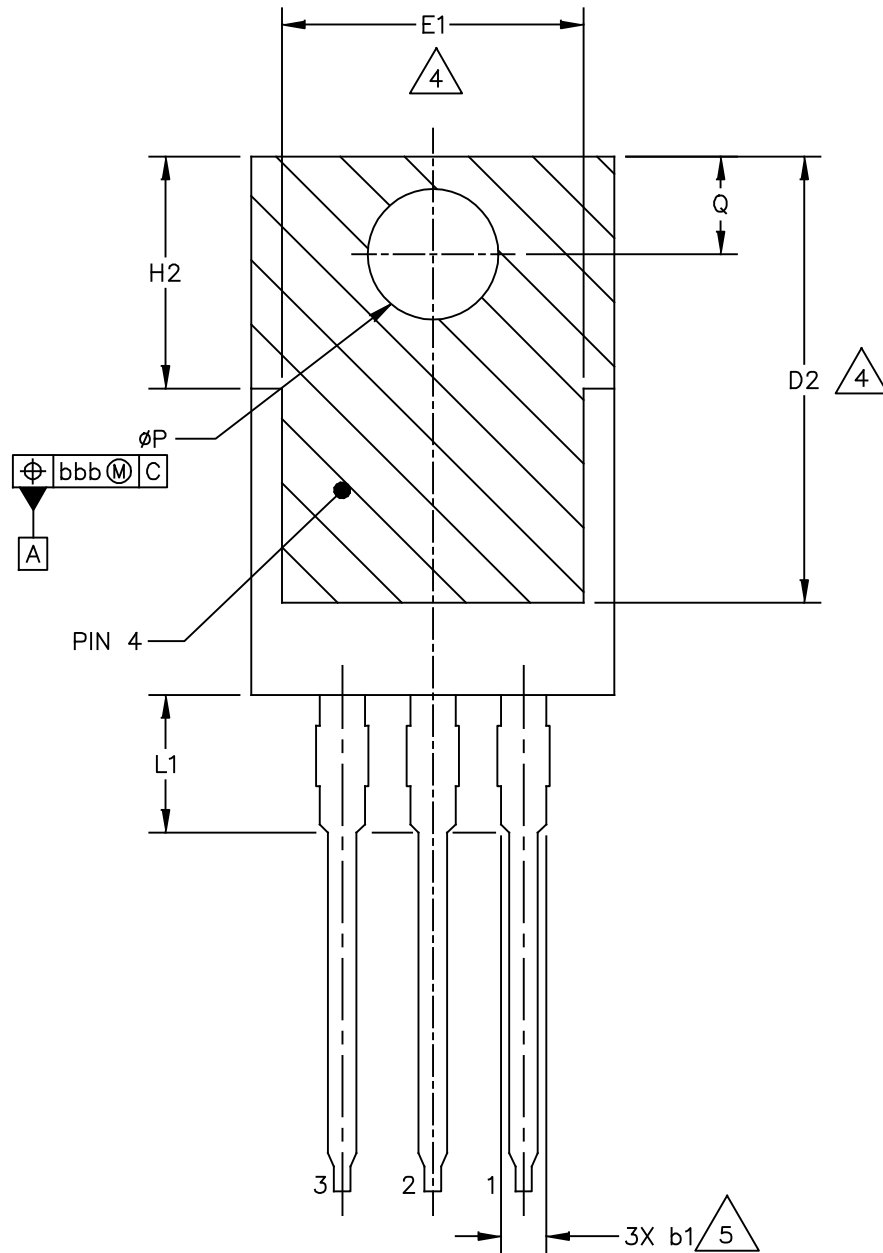
⊕ aaa (M) C A (M) B

© NXP B.V. ALL RIGHTS RESERVED

DATE: 13 FEB 2019

MECHANICAL OUTLINE PRINT VERSION NOT TO SCALE	STANDARD: NON JEDEC	DRAWING NUMBER: 98ASA01106D	REVISION: A	PAGE: 1 OF 3
--	------------------------	--------------------------------	----------------	-----------------

MRF101AN MRF101BN



© NXP B.V. ALL RIGHTS RESERVED

DATE: 13 FEB 2019

MECHANICAL OUTLINE PRINT VERSION NOT TO SCALE	STANDARD: NON JEDEC	DRAWING NUMBER: 98ASA01106D	REVISION: A	PAGE: 2
--	------------------------	--------------------------------	----------------	------------

NOTES:

1. CONTROLLING DIMENSION: MILLIMETER, ANGLES ARE IN DEGREES.
2. INTERPRET DIMENSIONS AND TOLERANCES AS PER ASME Y14.5M-1994.
3. DIMENSION D AND E DO NOT INCLUDE MOLD FLASH. MOLD FLASH SHALL NOT EXCEED 0.13 MM (.005 INCH) PER SIDE. THESE DIMENSIONS ARE MEASURED AT THE OUTERMOST EXTREME OF THE PLASTIC BODY.
4. HATCHING REPRESENTS THE EXPOSED AREA OF THE THERMAL PAD (PIN 4). DIMENSIONS D2 AND E1 REPRESENT THE VALUES BETWEEN THE TWO OPPOSITE POINTS ALONG THE EDGES OF THE EXPOSED AREA OF THE THERMAL PAD. THERMAL PAD CONTOUR OPTIONAL WITHIN DIMENSION D1 AND E1.
5. DIMENSIONS b1 DO NOT INCLUDE DAMBAR PROTRUSION. ALLOWABLE DAMBAR PROTRUSION SHALL BE 0.15 MM (.006 INCH) PER SIDE IN EXCESS OF THE DIMENSIONS b1 AT MAXIMUM MATERIAL CONDITION.
6. EJECTOR MARKS ON TOP SURFACE ARE PERMITTED AND IT IS SUPPLIER OPTION. THE MAXIMUM DEPTH OF EJECTOR MARK IS 0.25 MM (.010 INCH)

DIM	INCH		MILLIMETER		DIM	INCH		MILLIMETER	
	MIN	MAX	MIN	MAX		MIN	MAX	MIN	MAX
A	.167	.190	4.25	4.83	E1	.303	---	7.70	---
A1	.047	.053	1.20	1.34	e	.10 BSC		2.54 BSC	
A2	.098	.115	2.50	2.92	H1	.240	.264	6.10	6.70
b	.028	.038	0.71	0.97	H2	.240	.264	6.10	6.70
b1	.045	.070	1.14	1.78	L	.500	.567	12.70	14.40
c	.014	.024	0.356	0.61	L1	.144	.159	3.65	4.05
D	.564	.624	14.32	15.86	P	.142	.155	3.60	3.95
D1	.330	---	8.39	---	Q	.100	.119	2.54	3.04
D2	.480	.504	12.20	12.80	aaa	.014		0.35	
E	.392	.412	9.96	10.47	bbb	.014		0.35	

© NXP B.V. ALL RIGHTS RESERVED

DATE: 13 FEB 2019

MECHANICAL OUTLINE PRINT VERSION NOT TO SCALE	STANDARD: NON JEDEC	DRAWING NUMBER: 98ASAO1106D	REVISION: A	PAGE: 3
--	------------------------	--------------------------------	----------------	------------

MRF101AN MRF101BN

## PRODUCT DOCUMENTATION, SOFTWARE AND TOOLS

Refer to the following resources to aid your design process.

### Application Notes

- AN1955: Thermal Measurement Methodology of RF Power Amplifiers

### Engineering Bulletins

- EB212: Using Data Sheet Impedances for RF LDMOS Devices

### Software

- Electromigration MTTF Calculator
- RF High Power Model
- .s2p File

### Development Tools

- Printed Circuit Boards
- Baseplate

### To Download Resources Specific to a Given Part Number:

1. Go to <http://www.nxp.com/RF>
2. Search by part number
3. Click part number link
4. Choose the desired resource from the drop down menu

## REVISION HISTORY

The following table summarizes revisions to this document.

Revision	Date	Description
0	Nov. 2018	<ul style="list-style-type: none"><li>• Initial release of data sheet</li></ul>
1	May 2019	<ul style="list-style-type: none"><li>• Typical Performance table: updated values for 27 MHz, 50 MHz and 87.5–108 MHz reference circuits, p. 1</li><li>• Load Mismatch/Ruggedness table, 40.68 MHz <math>P_{in}</math>: modulation signal corrected to CW, p. 1</li><li>• Fig. 2, MTTF versus Junction Temperature — CW: added, p. 4</li><li>• Added 13.56 MHz compact reference circuit, pp. 5–8</li><li>• Added 27 MHz compact reference circuit, pp. 9–12</li><li>• Table 13, row C12, C13: unit of measure/value in Description column changed from 10 nF to 0.01 <math>\mu</math>F, p. 14</li><li>• Added 50 MHz compact reference circuit, pp. 17–20</li><li>• Added 81.36 MHz reference circuit, pp. 21–24</li><li>• Added 87.5–108 MHz compact broadband reference circuit, pp. 25–29</li><li>• Table 21, row C13: unit of measure/value in Description column changed from 10 nF to 0.01 <math>\mu</math>F, p. 31</li><li>• Fig. 42, CW Output Power versus Gate–Source Voltage at a Constant Input Power: added, p. 32</li><li>• Package Outline Drawing: TO–220–3 package outline updated to Rev. A, pp. 37–39</li></ul>