



RF Power LDMOS Transistors

N-Channel Enhancement-Mode Lateral MOSFETs

These 750 W CW transistors are designed for industrial, scientific and medical (ISM) applications in the 700 to 1300 MHz frequency range. The transistors are capable of CW or pulse power in narrowband operation.

Typical Performance: $V_{DD} = 50 \text{ Vdc}$

Frequency (MHz)	Signal Type	P_{out} (W)	G_{ps} (dB)	η_D (%)
915 ⁽¹⁾	CW	750	19.3	67.1
915 ⁽²⁾	Pulse (100 μsec , 10% Duty Cycle)	850	20.5	69.2
1300 ⁽³⁾	CW	700	17.2	56.0

Load Mismatch/Ruggedness

Frequency (MHz)	Signal Type	VSWR	P_{in} (W)	Test Voltage	Result
915 ⁽²⁾	Pulse (100 μsec , 10% Duty Cycle)	> 10:1 at all Phase Angles	15.9 Peak (3 dB Overdrive)	50	No Device Degradation

1. Measured in 915 MHz narrowband reference circuit (page 5).
2. Measured in 915 MHz narrowband production test fixture (page 11).
3. Measured in 1300 MHz narrowband reference circuit (page 8).

Features

- Internally input pre-matched for ease of use
- Device can be used single-ended or in a push-pull configuration
- Characterized for 30 to 50 V
- Suitable for linear applications with appropriate biasing
- Integrated ESD protection
- Recommended driver: MRFE6VS25GN (25 W)
- Included in NXP product longevity program with assured supply for a minimum of 15 years after launch

Typical Applications

- 915 MHz industrial heating/welding systems
- 1300 MHz particle accelerators

MRF13750H MRF13750HS

**700–1300 MHz, 750 W CW, 50 V
 RF POWER LDMOS TRANSISTORS**

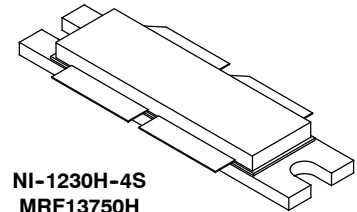

NI-1230H-4S
 MRF13750H

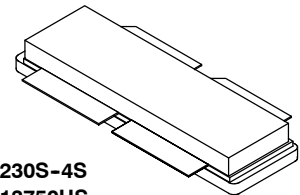

NI-1230S-4S
 MRF13750HS

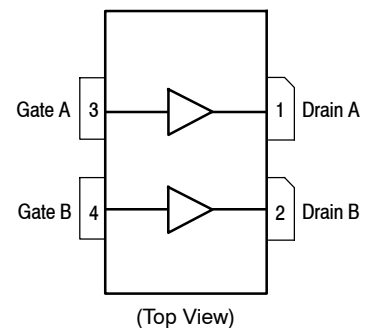

Note: The backside of the package is the source terminal for the transistor.

Figure 1. Pin Connections

Table 1. Maximum Ratings

Rating	Symbol	Value	Unit
Drain-Source Voltage	V_{DSS}	-0.5, +105	Vdc
Gate-Source Voltage	V_{GS}	-6.0, +10	Vdc
Operating Voltage	V_{DD}	55, +0	Vdc
Storage Temperature Range	T_{stg}	-65 to +150	°C
Case Operating Temperature Range	T_C	-40 to +150	°C
Operating Junction Temperature Range ^(1,2)	T_J	-40 to +225	°C
Total Device Dissipation @ $T_C = 25^\circ\text{C}$ Derate above 25°C	P_D	1333 6.67	W W/°C

Table 2. Thermal Characteristics

Characteristic	Symbol	Value ^(2,3)	Unit
Thermal Resistance, Junction to Case CW: Case Temperature 82°C, 700 W CW, 50 Vdc, $I_{DQ(A+B)} = 150$ mA, 915 MHz	$R_{\theta JC}$	0.15	°C/W
Thermal Impedance, Junction to Case Pulse: Case Temperature 76°C, 850 W Peak, 100 μsec Pulse Width, 10% Duty Cycle, 50 Vdc, $I_{DQ(A+B)} = 200$ mA, 915 MHz	$Z_{\theta JC}$	0.014	°C/W

Table 3. ESD Protection Characteristics

Test Methodology	Class
Human Body Model (per JESD22-A114)	2, passes 2500 V
Charge Device Model (per JESD22-C101)	C3, passes 1200 V

Table 4. Electrical Characteristics ($T_A = 25^\circ\text{C}$ unless otherwise noted)

Characteristic	Symbol	Min	Typ	Max	Unit
----------------	--------	-----	-----	-----	------

Off Characteristics⁽⁴⁾

Gate-Source Leakage Current ($V_{GS} = 5$ Vdc, $V_{DS} = 0$ Vdc)	I_{GSS}	—	—	1	μAdc
Drain-Source Breakdown Voltage ($V_{GS} = 0$ Vdc, $I_D = 10$ μA)	$V_{(BR)DSS}$	105	—	—	Vdc
Zero Gate Voltage Drain Leakage Current ($V_{DS} = 55$ Vdc, $V_{GS} = 0$ Vdc)	I_{DSS}	—	—	1	μAdc
Zero Gate Voltage Drain Leakage Current ($V_{DS} = 105$ Vdc, $V_{GS} = 0$ Vdc)	I_{DSS}	—	—	10	μAdc

On Characteristics

Gate Threshold Voltage ⁽⁴⁾ ($V_{DS} = 10$ Vdc, $I_D = 275$ μAdc)	$V_{GS(th)}$	1.3	1.72	2.3	Vdc
Gate Quiescent Voltage ($V_{DD} = 50$ Vdc, $I_{DQ(A+B)} = 200$ mAdc, Measured in Functional Test)	$V_{GS(Q)}$	1.7	2.2	2.7	Vdc
Drain-Source On-Voltage ⁽⁴⁾ ($V_{GS} = 10$ Vdc, $I_D = 2.8$ Adc)	$V_{DS(on)}$	0.1	0.23	0.6	Vdc

Dynamic Characteristics^(4,5)

Reverse Transfer Capacitance ($V_{DS} = 50$ Vdc ± 30 mV(rms)ac @ 1 MHz, $V_{GS} = 0$ Vdc)	C_{rss}	—	1.94	—	pF
Output Capacitance ($V_{DS} = 50$ Vdc ± 30 mV(rms)ac @ 1 MHz, $V_{GS} = 0$ Vdc)	C_{oss}	—	63.8	—	pF

1. Continuous use at maximum temperature will affect MTTF.
2. MTTF calculator available at <http://www.nxp.com/RF/calculators>.
3. Refer to AN1955, *Thermal Measurement Methodology of RF Power Amplifiers*. Go to <http://www.nxp.com/RF> and search for AN1955.
4. Each side of device measured separately.
5. Part internally input pre-matched.

(continued)

Table 4. Electrical Characteristics ($T_A = 25^\circ\text{C}$ unless otherwise noted) (continued)

Characteristic	Symbol	Min	Typ	Max	Unit
Functional Tests (In NXP Narrowband Production Test Fixture, 50 ohm system) $V_{DD} = 50\text{ Vdc}$, $I_{DQ(A+B)} = 200\text{ mA}$, $P_{out} = 850\text{ W Peak}$ (85 W Avg.), $f = 915\text{ MHz}$, 100 μsec Pulse Width, 10% Duty Cycle					
Power Gain	G_{ps}	19.5	20.5	21.5	dB
Drain Efficiency	η_D	66.0	69.2	—	%

Table 5. Load Mismatch/Ruggedness (In NXP Narrowband Production Test Fixture, 50 ohm system) $I_{DQ(A+B)} = 200\text{ mA}$

Frequency (MHz)	Signal Type	VSWR	P_{in} (W)	Test Voltage, V_{DD}	Result
915	Pulse (100 μsec , 10% Duty Cycle)	> 10:1 at all Phase Angles	15.9 Peak (3 dB Overdrive)	50	No Device Degradation

Table 6. Ordering Information

Device	Tape and Reel Information	Package
MRF13750HR5	R5 Suffix = 50 Units, 56 mm Tape Width, 13-inch Reel	NI-1230H-4S
MRF13750HSR5		NI-1230S-4S

TYPICAL CHARACTERISTICS

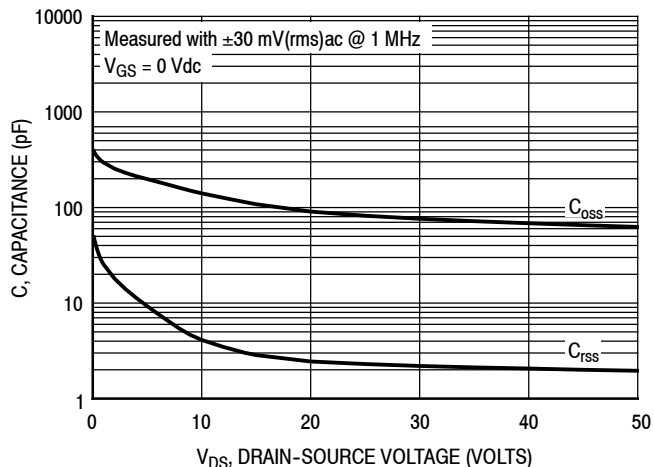

Note: Each side of device measured separately.

Figure 2. Capacitance versus Drain-Source Voltage

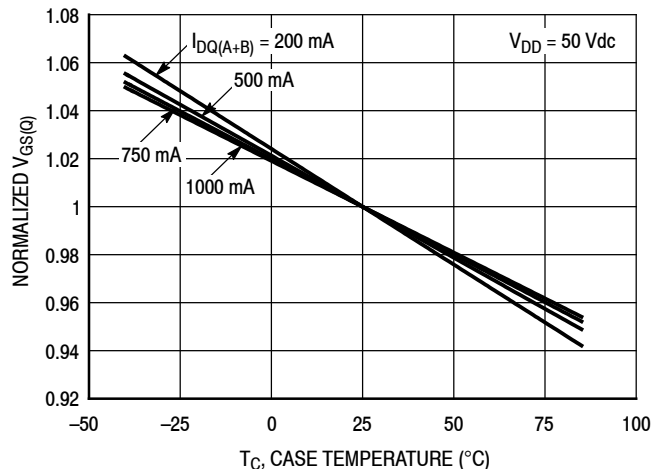

I_{DQ} (mA)	Slope (mV/°C)
200	-2.168
500	-1.992
750	-1.903
1000	-1.854

Figure 3. Normalized V_{GS} versus Quiescent Current and Case Temperature

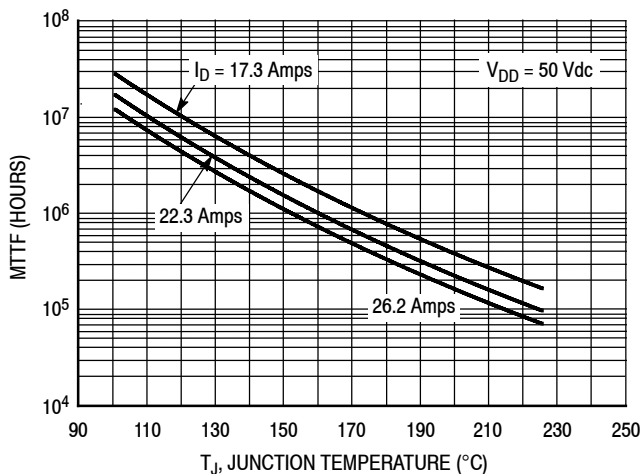

Note: MTF value represents the total cumulative operating time under indicated test conditions.

MTF calculator available at <http://www.nxp.com/RF/calculators>.

Figure 4. MTF versus Junction Temperature – CW

915 MHz NARROWBAND REFERENCE CIRCUIT – 3.0" x 3.8" (7.6 cm x 9.7 cm)

Table 7. 915 MHz Narrowband Performance (In NXP Reference Circuit, 50 ohm system)

$V_{DD} = 50$ Vdc, $I_{DQ(A+B)} = 150$ mA, $P_{in} = 8.8$ W

Frequency (MHz)	Signal Type	P_{out} (W)	G_{ps} (dB)	η_D (%)
915	CW	750	19.3	67.1

915 MHz NARROWBAND REFERENCE CIRCUIT – 3.0" x 3.8" (7.6 cm x 9.7 cm)

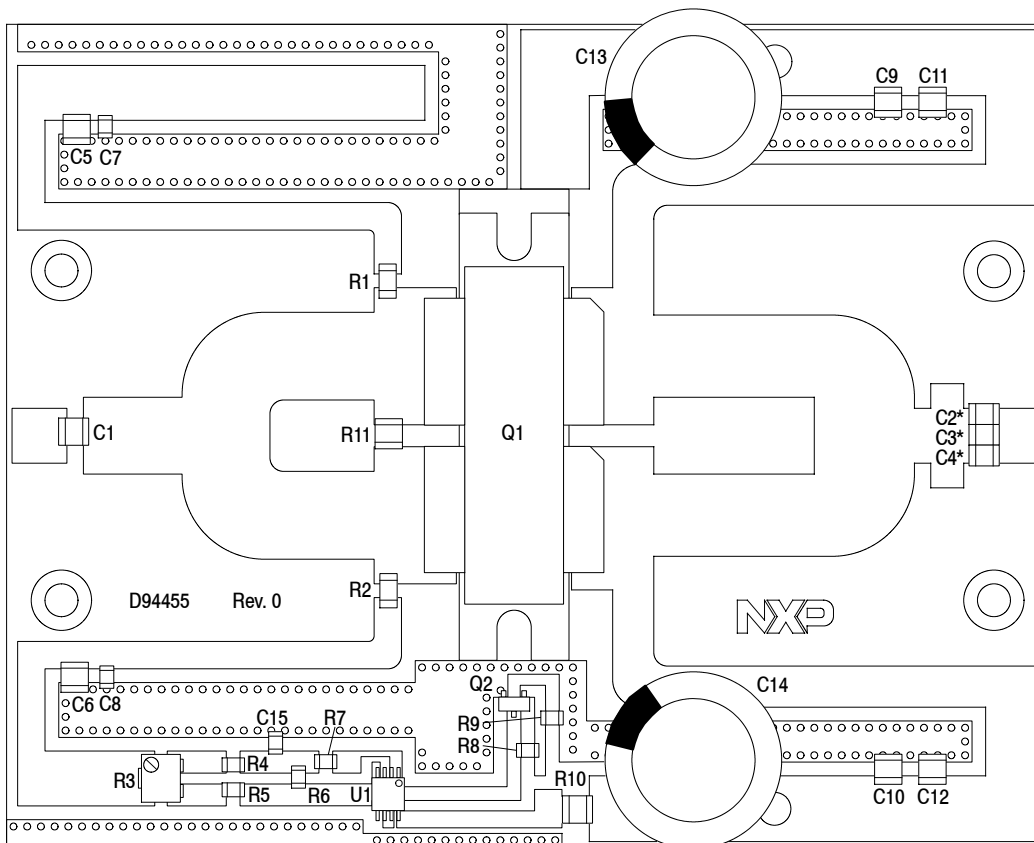

*C2, C3 and C4 are mounted vertically.

Figure 5. MRF13750H Narrowband Reference Circuit Component Layout – 915 MHz

Table 8. MRF13750H Narrowband Reference Circuit Component Designations and Values – 915 MHz

Part	Description	Part Number	Manufacturer
C1, C2, C3, C4, C5, C6, C11, C12	47 pF Chip Capacitor	ATC100B470JT500XT	ATC
C7, C8, C15	1 μ F Chip Capacitor	GRM21BR71H105KA12L	Murata
C9, C10	1000 pF Chip Capacitor	ATC100B102JT50XT	ATC
C13, C14	470 μ F, 100 V Electrolytic Capacitor	MCGPR100V477M16X32-RH	Multicomp
Q1	RF Power LDMOS Transistor	MRF13750H	NXP
Q2	NPN Bipolar Transistor	BC847ALT1G	ON Semiconductor
R1, R2	10 Ω , 1/4 W Chip Resistor	CRCW120610R0JNEA	Vishay
R3	5 k Ω Multi-turn Cermet Trimmer Potentiometer	3224W-1-502E	Bourns
R4	20 k Ω , 1/10 W Chip Resistor	RR1220P-203-B-T5	Susumu
R5	4.7 k Ω , 1/10 W Chip Resistor	RR1220P-472-D	Susumu
R6, R8	1.2 k Ω , 1/8 W Chip Resistor	CRCW08051K20FKEA	Vishay
R7	10 Ω , 1/8 W Chip Resistor	CRCW080510R0FKEA	Vishay
R9	2.2 k Ω , 1/8 W Chip Resistor	CRCW08052K20JNEA	Vishay
R10	4.7 k Ω , 1/2 W Chip Resistor	CRCW12104K70FKEA	Vishay
R11	2 Ω , 1/2 W Chip Resistor	ERJ-14YJ2R0U	Panasonic
U1	Voltage Regulator 5 V, Micro8	LP2951ACDMR2G	ON Semiconductor
PCB	Rogers TC600, 0.025", $\epsilon_r = 6.15$	D94455	MTL

MRF13750H MRF13750HS

TYPICAL CHARACTERISTICS – 915 MHz NARROWBAND REFERENCE CIRCUIT

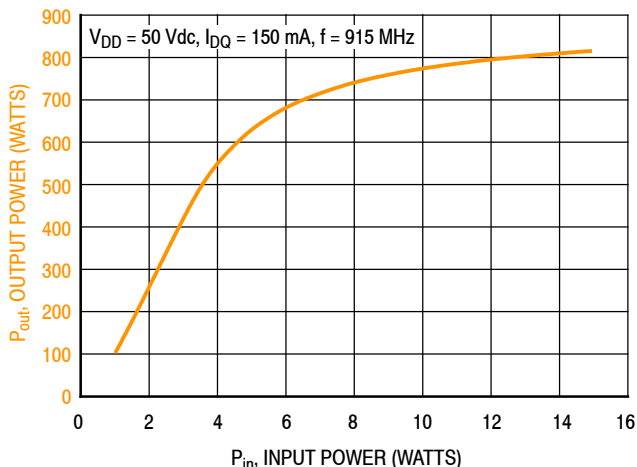

f (MHz)	P1dB (W)	P3dB (W)
915	690	800

Figure 6. CW Output Power versus Input Power

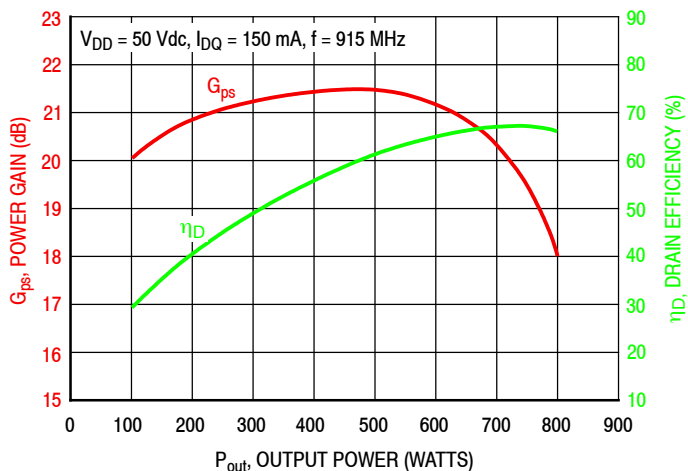

Figure 7. Power Gain and Drain Efficiency versus CW Output Power

f MHz	Z _{source} Ω	Z _{load} Ω
915	0.58 + j0.24	0.59 + j1.19

Z_{source} = Test circuit impedance as measured from gate to ground.

Z_{load} = Test circuit impedance as measured from drain to ground.

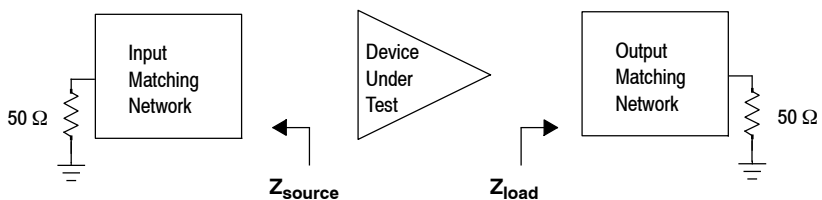

Figure 8. Narrowband Series Equivalent Source and Load Impedance – 915 MHz

1300 MHz NARROWBAND REFERENCE CIRCUIT – 3.0" × 3.9" (7.6 cm × 9.9 cm)

Table 9. 1300 MHz Narrowband Performance (In NXP Reference Circuit, 50 ohm system)

$V_{DD} = 50$ Vdc, $I_{DQ(A+B)} = 150$ mA, $P_{in} = 11$ W

Frequency (MHz)	Signal Type	P_{out} (W)	G_{ps} (dB)	η_D (%)
1300	CW	700	17.2	56.0

1300 MHz NARROWBAND REFERENCE CIRCUIT – 3.0" x 3.9" (7.6 cm x 9.9 cm)

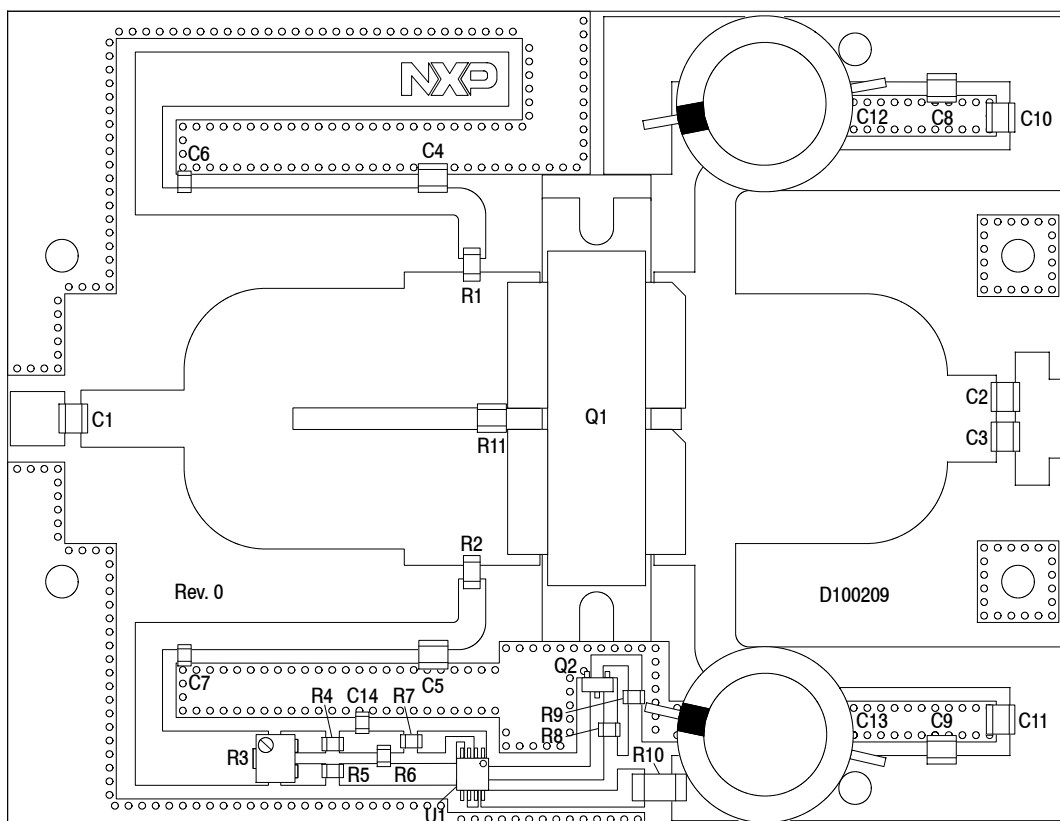
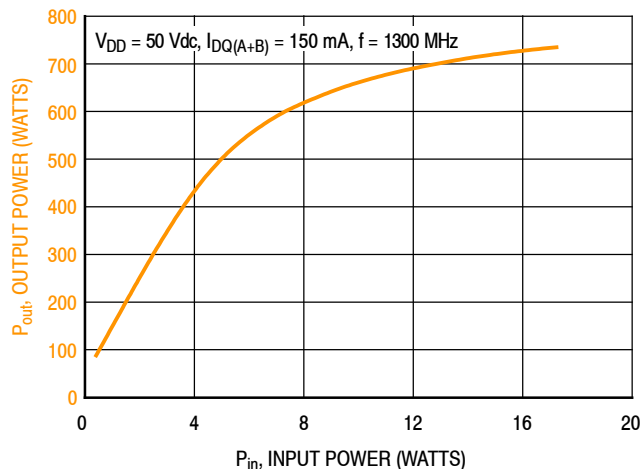

Figure 9. MRF13750H Narrowband Reference Circuit Component Layout – 1300 MHz

Table 10. MRF13750H Narrowband Reference Circuit Component Designations and Values – 1300 MHz

Part	Description	Part Number	Manufacturer
C1, C4, C5, C10, C11	24 pF Chip Capacitor	ATC100B240JT500XT	ATC
C2, C3	18 pF Chip Capacitor	ATC100B180JT500XT	ATC
C6, C7, C14	1 μ F Chip Capacitor	GRM21BR71H105KA12L	Murata
C8, C9	1000 pF Chip Capacitor	ATC100B102JT50XT	ATC
C12, C13	470 μ F, 100 V Electrolytic Capacitor	MCGPR100V477M16X32-RH	Multicomp
R1, R2	10 Ω , 1/4 W Chip Resistor	CRCW120610R0JNEA	Vishay
R3	5 k Ω Multi-turn Cermet Trimmer Potentiometer	3224W-1-502E	Bourns
R4	20 k Ω , 1/8 W Chip Resistor	CRCW080520K0FKEA	Vishay
R5	4.7 k Ω , 1/8 W Chip Resistor	CRCW08054K70FKEA	Vishay
R6, R8	1.2 k Ω , 1/8 W Chip Resistor	CRCW08051K20FKEA	Vishay
R7	10 Ω , 1/8 W Chip Resistor	CRCW080510R0FKEA	Vishay
R9	2.2 k Ω , 1/8 W Chip Resistor	CRCW08052K20JNEA	Vishay
R10	4.7 k Ω , 1/2 W Chip Resistor	CRCW12104K70FKEA	Vishay
R11	3.3 Ω , 1/2 W Chip Resistor	ERJ-14YJ3R3U	Panasonic
Q1	RF Power LDMOS Transistor	MRF13750H	NXP
Q2	NPN Bipolar Transistor	BC847ALT1G	ON Semiconductor
U1	Voltage Regulator 5 V, Micro8	LP2951ACDMR2G	ON Semiconductor
PCB	Arlon TC350, 0.020", $\epsilon_r = 3.5$	D100209	MTL

**TYPICAL CHARACTERISTICS – 1300 MHz
NARROWBAND REFERENCE CIRCUIT**



f (MHz)	P1dB (W)	P3dB (W)
1300	600	710

Figure 10. CW Output Power versus Input Power

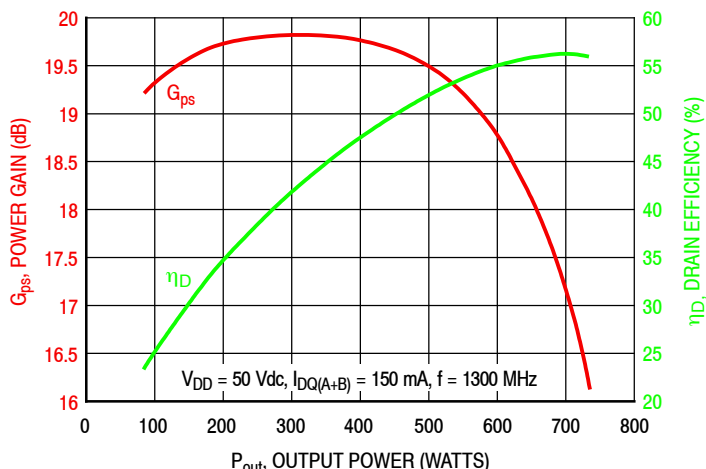

Figure 11. Power Gain and Drain Efficiency versus CW Output Power

f MHz	Z _{source} Ω	Z _{load} Ω
1300	0.64 + j1.92	0.39 + j0.92

Z_{source} = Test circuit impedance as measured from gate to ground.

Z_{load} = Test circuit impedance as measured from drain to ground.

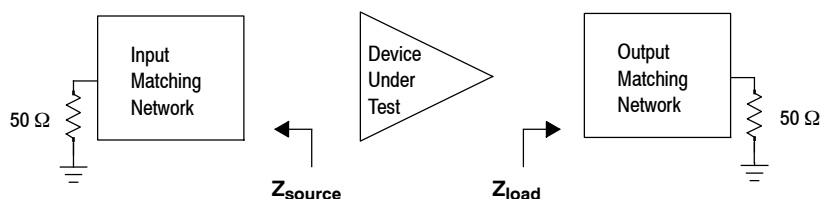
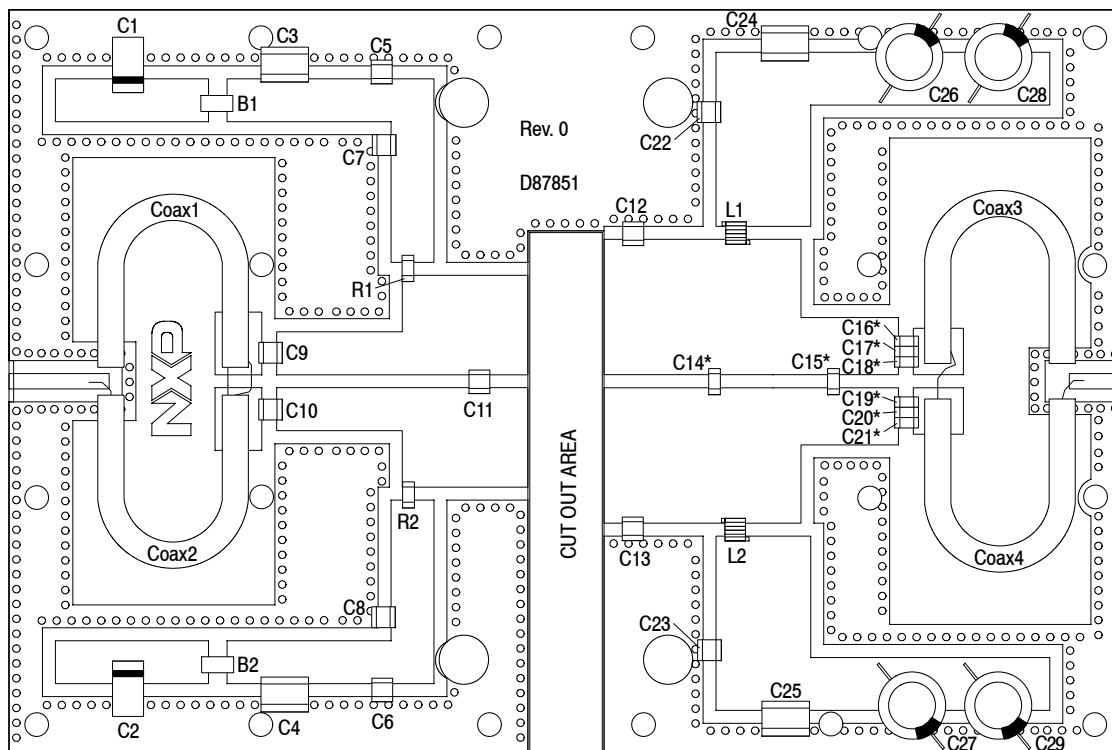

Figure 12. Narrowband Series Equivalent Source and Load Impedance – 1300 MHz

915 MHz NARROWBAND PRODUCTION TEST FIXTURE – 4.0" x 6.0" (10.2 cm x 15.2 cm)



*C14, C15, C16, C17, C18, C19, C20 and C21 are mounted vertically.

Figure 13. MRF13750H Narrowband Production Test Fixture Component Layout – 915 MHz

Table 11. MRF13750H Narrowband Production Test Fixture Component Designations and Values – 915 MHz

Part	Description	Part Number	Manufacturer
B1, B2	RF Bead, Short	2743019447	Fair-Rite
C1, C2	22 μ F, 35 V Tantalum Capacitor	T491X226K035AT	Kemet
C3, C4	2.2 μ F Chip Capacitor	C1825C225J5RAC	Kemet
C5, C6	0.1 μ F Chip Capacitor	CDR33BX104AKWS	AVX
C7, C8, C22, C23	36 pF Chip Capacitor	ATC100B360JT500XT	ATC
C9, C10	10 pF Chip Capacitor	ATC100B100JT500XT	ATC
C11	13 pF Chip Capacitor	ATC100B130JT500XT	ATC
C12, C13	12 pF Chip Capacitor	ATC100B120JT500XT	ATC
C14, C15	7.5 pF Chip Capacitor	ATC100B7R5CT500XT	ATC
C16, C17, C18, C19, C20, C21	36 pF Chip Capacitor	ATC100B360JT500XT	ATC
C24, C25	0.01 μ F Chip Capacitor	C1825C103K1GAC-TU	Kemet
C26, C27, C28, C29	470 μ F, 63 V Electrolytic Capacitor	MCGPR63V477M13X26-RH	Multicomp
Coax1, 2, 3, 4	25 Ω , Semi Rigid Coax, 2.2" Shield Length	UT-141C-25	Micro Coax
L1, L2	5 nH Inductor	A02TKLC	Coilcraft
R1, R2	10 Ω , 3/4 W Chip Resistor	CRCW201010R0FKEF	Vishay
PCB	Arlon, AD255A, 0.03", $\epsilon_r = 2.55$	D87851	MTL

**TYPICAL CHARACTERISTICS – 915 MHz, $T_C = 25^\circ\text{C}$
PRODUCTION TEST FIXTURE**

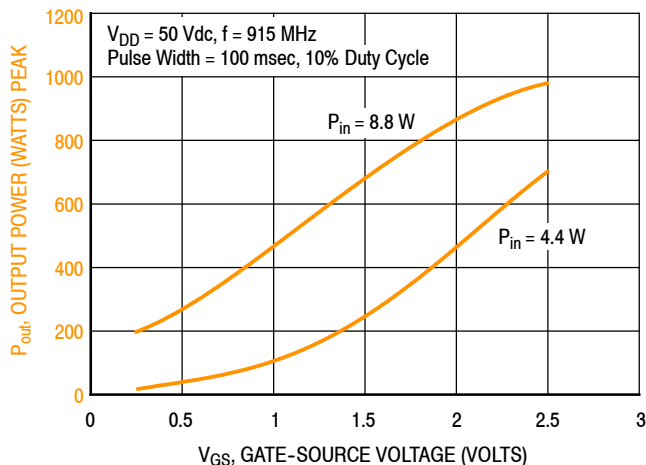
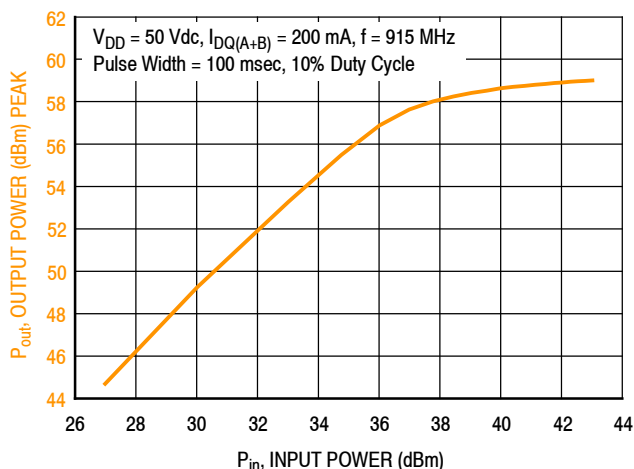

Figure 14. Output Power versus Gate-Source Voltage at a Constant Input Power



f (MHz)	P1dB (W)	P3dB (W)
915	802	912

Figure 15. Output Power versus Input Power

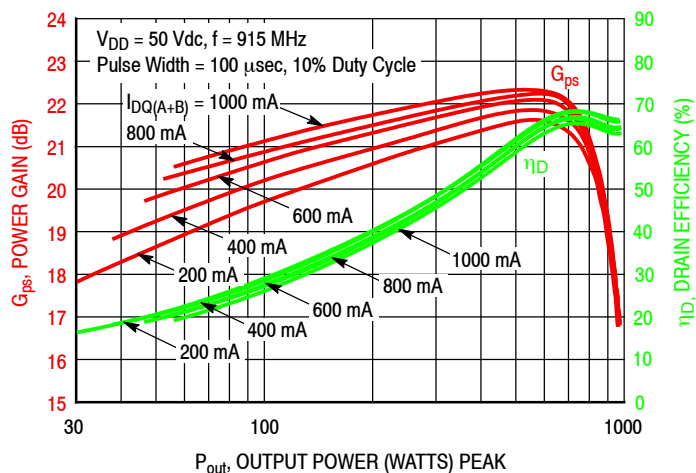

Figure 16. Power Gain and Drain Efficiency versus Output Power and Quiescent Current

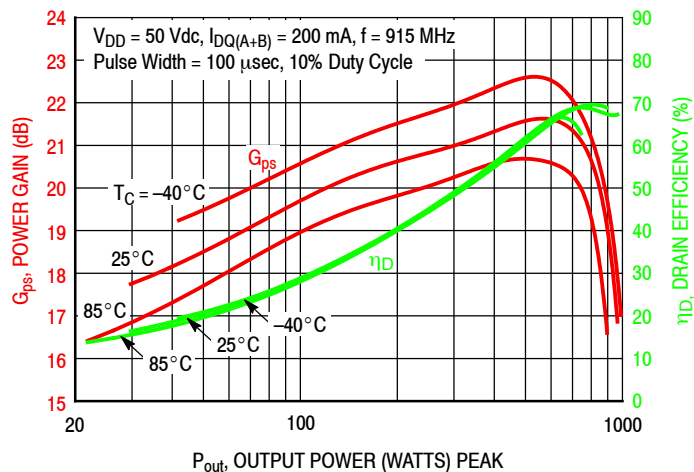

Figure 17. Power Gain and Drain Efficiency versus Output Power

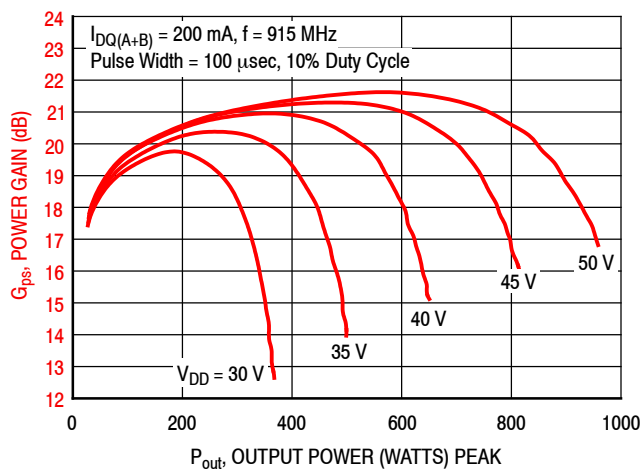

Figure 18. Power Gain versus Output Power and Drain-Source Voltage

915 MHz NARROWBAND PRODUCTION TEST FIXTURE

f MHz	Z_{source} Ω	Z_{load} Ω
915	$3.46 - j1.76$	$2.39 + j3.92$

Z_{source} = Test fixture impedance as measured from gate to gate, balanced configuration.

Z_{load} = Test fixture impedance as measured from drain to drain, balanced configuration.

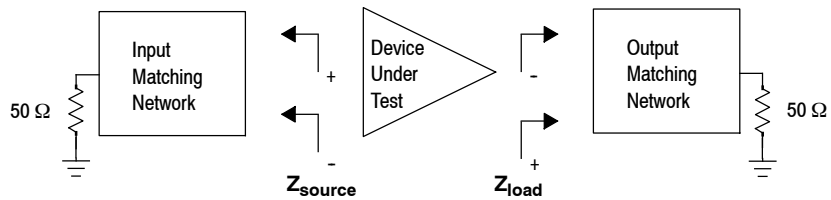
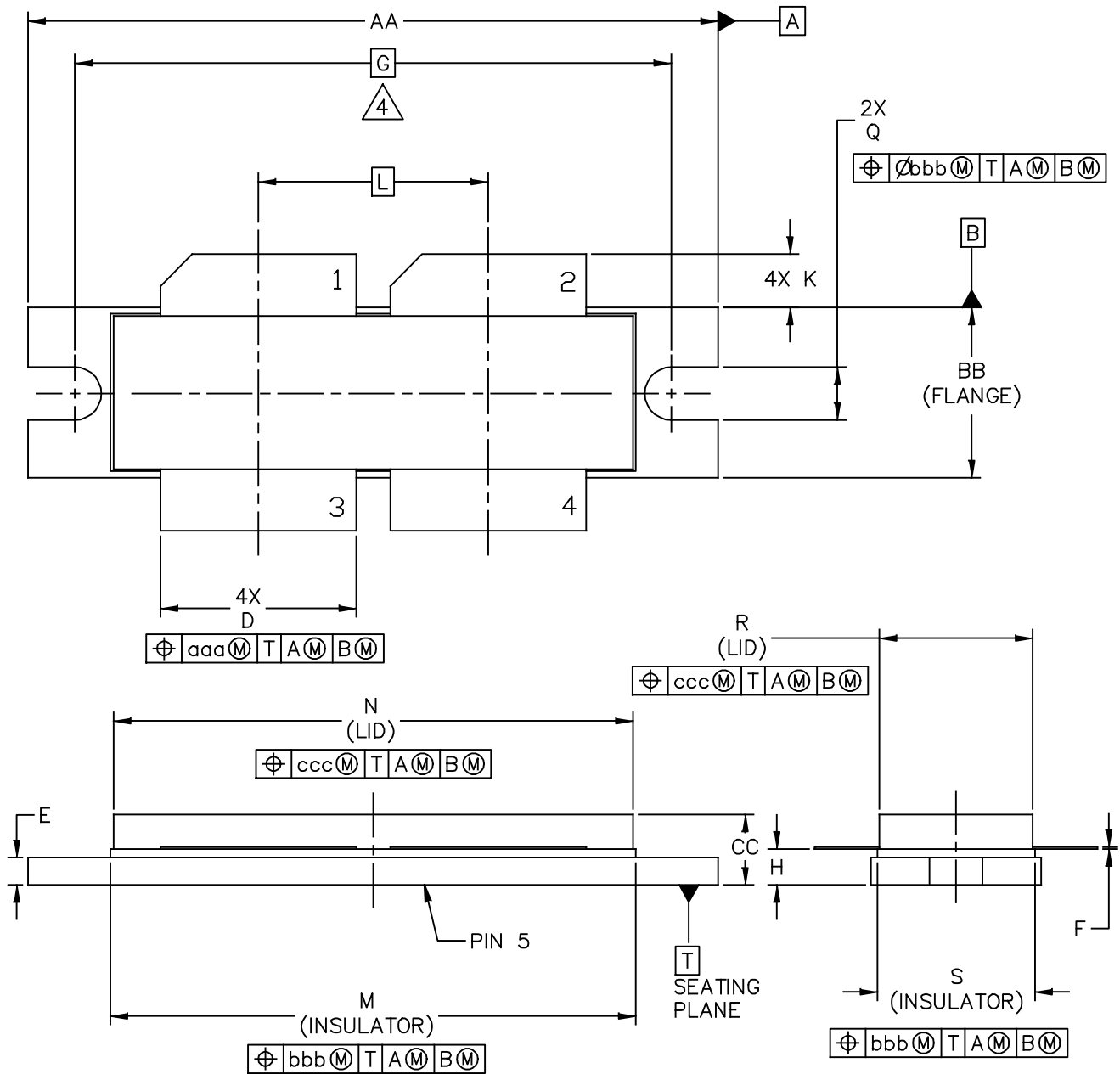



Figure 19. Narrowband Series Equivalent Source and Load Impedance – 915 MHz

PACKAGE DIMENSIONS



© NXP SEMICONDUCTORS N.V. ALL RIGHTS RESERVED	MECHANICAL OUTLINE	PRINT VERSION NOT TO SCALE
TITLE: NI-1230-4H	DOCUMENT NO: 98ASB16977C	REV: G
	STANDARD: NON-JEDEC	
	SOT1787-1	03 MAR 2016

NOTES:

1. INTERPRET DIMENSIONS AND TOLERANCES PER ASME Y14.5M-1994.
2. CONTROLLING DIMENSION: INCH
3. DIMENSION H IS MEASURED .030 INCH (0.762 MM) AWAY FROM PACKAGE BODY.
4.  RECOMMENDED BOLT CENTER DIMENSION OF 1.52 INCH (38.61 MM) BASED ON M3 SCREW.

DIM	INCH		MILLIMETER		DIM	INCH		MILLIMETER	
	MIN	MAX	MIN	MAX		MIN	MAX	MIN	MAX
AA	1.615	1.625	41.02	41.28	N	1.218	1.242	30.94	31.55
BB	.395	.405	10.03	10.29	Q	.120	.130	3.05	3.30
CC	.170	.190	4.32	4.83	R	.355	.365	9.02	9.27
D	.455	.465	11.56	11.81	S	.365	.375	9.27	9.53
E	.062	.066	1.57	1.68					
F	.004	.007	0.10	0.18					
G	1.400 BSC		35.56 BSC		aaa	.013		0.33	
H	.082	.090	2.08	2.29	bbb	.010		0.25	
K	.117	.137	2.97	3.48	ccc	.020		0.51	
L	.540 BSC		13.72 BSC						
M	1.219	1.241	30.96	31.52					
© NXP SEMICONDUCTORS N.V. ALL RIGHTS RESERVED			MECHANICAL OUTLINE			PRINT VERSION NOT TO SCALE			
TITLE:					DOCUMENT NO: 98ASB16977C REV: G				
NI-1230-4H					STANDARD: NON-JEDEC				
					SOT1787-1		03 MAR 2016		

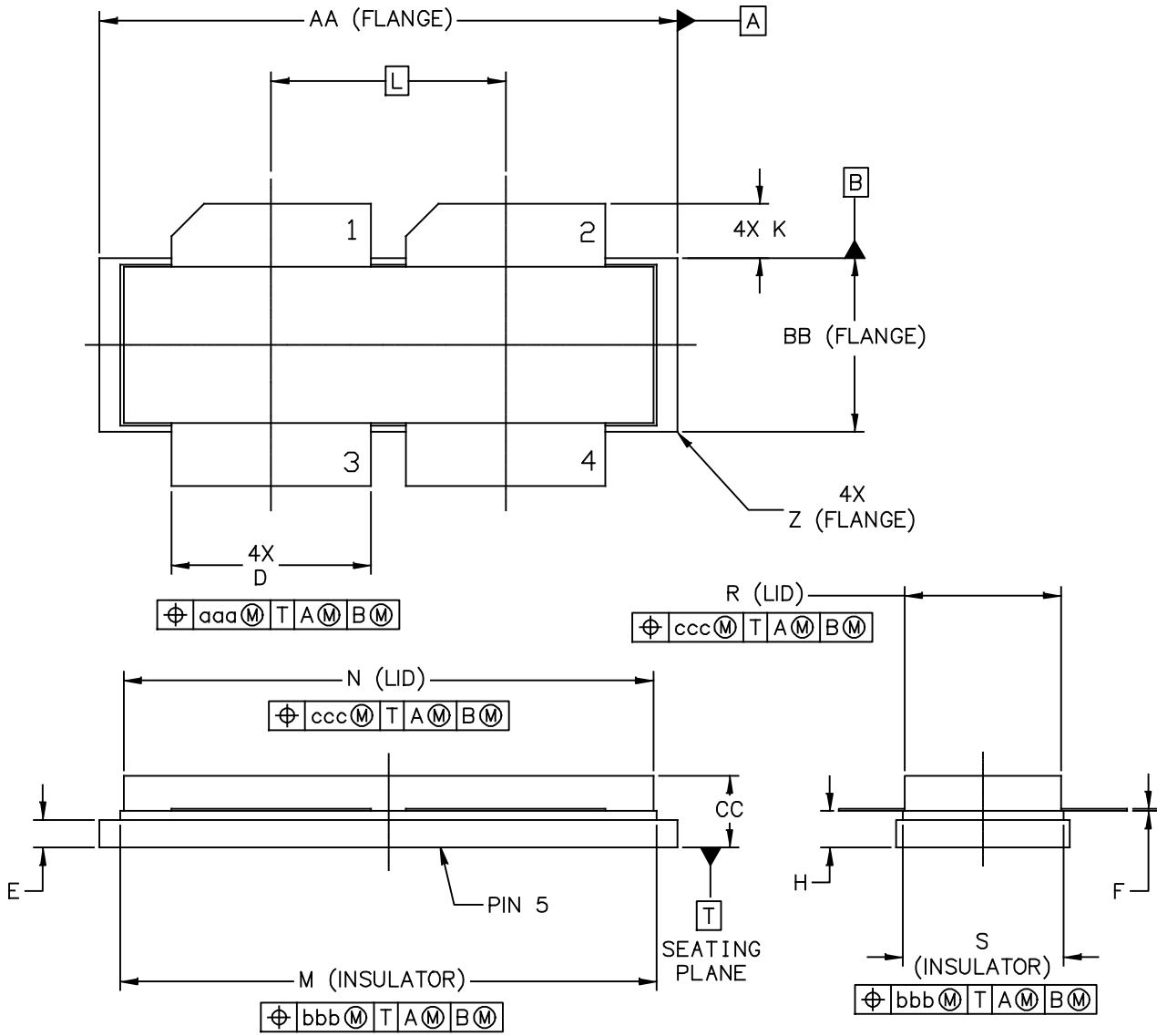

© NXP SEMICONDUCTORS N. V. ALL RIGHTS RESERVED	MECHANICAL OUTLINE	PRINT VERSION NOT TO SCALE
TITLE: NI-1230-4S	DOCUMENT NO: 98ARB18247C	REV: H
	STANDARD: NON-JEDEC	
	SOT1829-1	19 FEB 2016

NOTES:

1. INTERPRET DIMENSIONS AND TOLERANCES PER ASME Y14.5M-1994.
2. CONTROLLING DIMENSION: INCH
3. DIMENSION H IS MEASURED .030 INCH (0.762 MM) AWAY FROM PACKAGE BODY

DIM	INCHES		MILLIMETERS		DIM	INCHES		MILLIMETERS	
	MIN	MAX	MIN	MAX		MIN	MAX	MIN	MAX
AA	1.265	1.275	32.13	32.39	R	.355	.365	9.02	9.27
BB	.395	.405	10.03	10.29	S	.365	.375	9.27	9.53
CC	.170	.190	4.32	4.83	Z	R.000	R.040	R0.00	R1.02
D	.455	.465	11.56	11.81					
E	.062	.066	1.57	1.68	aaa	.013		0.33	
F	.004	.007	0.10	0.18	bbb	.010		0.25	
H	.082	.090	2.08	2.29	ccc	.020		0.51	
K	.117	.137	2.97	3.48					
L	.540 BSC		13.72 BSC						
M	1.219	1.241	30.96	31.52					
N	1.218	1.242	30.94	31.55					
© NXP SEMICONDUCTORS N.V. ALL RIGHTS RESERVED			MECHANICAL OUTLINE			PRINT VERSION NOT TO SCALE			
TITLE: NI-1230-4S					DOCUMENT NO: 98ARB18247C REV: H				
					STANDARD: NON-JEDEC				
					SOT1829-1			19 FEB 2016	

PRODUCT DOCUMENTATION, SOFTWARE AND TOOLS

Refer to the following resources to aid your design process.

Application Notes

- AN1908: Solder Reflow Attach Method for High Power RF Devices in Air Cavity Packages
- AN1955: Thermal Measurement Methodology of RF Power Amplifiers

Engineering Bulletins

- EB212: Using Data Sheet Impedances for RF LDMOS Devices

Software

- Electromigration MTTF Calculator
- RF High Power Model
- .s2p File

Development Tools

- Printed Circuit Boards

To Download Resources Specific to a Given Part Number:

1. Go to <http://www.nxp.com/RF>
2. Search by part number
3. Click part number link
4. Choose the desired resource from the drop down menu

REVISION HISTORY

The following table summarizes revisions to this document.

Revision	Date	Description
0	Dec. 2017	• Initial release of data sheet
1	Jan. 2018	• On Characteristics, $V_{GS(Q)}$: Min and Max values updated to reflect recent test results of the device, p. 2