

MSC130SM120JCU3
Datasheet
Buck Chopper SiC MOSFET Power Module

January 2020



a  **MICROCHIP** company

Contents

Revision History.....	1
1.1 Revision 1.0.....	1
Product Overview.....	2
2.1 Features.....	3
2.2 Benefits.....	3
2.3 Applications.....	3
Electrical Specifications.....	4
3.1 SiC MOSFET Characteristics.....	4
3.2 SiC Chopper Diode Ratings and Characteristics.....	6
3.3 Thermal and Package Characteristics.....	6
3.4 SiC MOSFET Performance Curves.....	7
3.5 Typical SiC Diode Performance Curves.....	10
Package Specifications.....	11
4.1 Package Outline Drawing.....	11

1 Revision History

The revision history describes the changes that were implemented in the document. The changes are listed by revision, starting with the most current publication.

1.1 Revision 1.0

Revision 1.0 was published in January 2020. It is the first publication of this document.

2 Product Overview

The MSC130SM120JCU3 device is a 1200 V, 173 A full Silicon Carbide power module.

Figure 1 • Electrical Schematic of MSC130SM120JCU3 Device

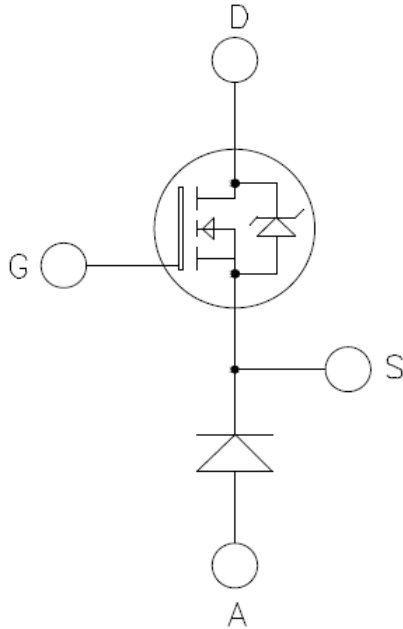
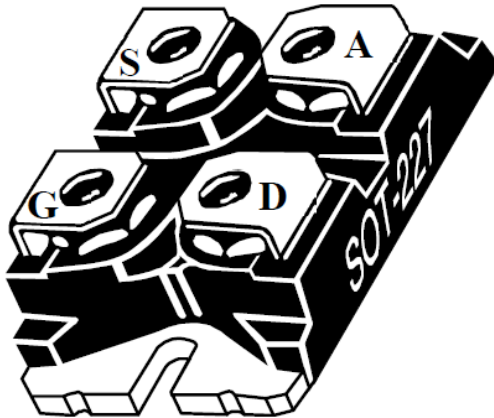

Figure 2 • SOT-227 Pinout Location



All ratings at $T_j = 25\text{ }^\circ\text{C}$, unless otherwise specified.

Caution: These devices are sensitive to electrostatic discharge. Proper handling procedures should be followed.

2.1 Features

The following are key features of the MSC130SM120JCU3 device:

- Silicon Carbide (SiC) Power MOSFET
 - Low $R_{DS(on)}$
 - High temperature performance
- SiC Schottky Diode
 - Zero reverse recovery
 - Zero forward recovery
 - Temperature independent switching behavior
 - Positive temperature coefficient on VF

2.2 Benefits

The following are benefits of the MSC130SM120JCU3 device:

- High efficiency converter
- Very low stray inductance
- Outstanding performance at high frequency operation
- Stable temperature behavior
- Direct mounting to heatsink (isolated package)
- Low junction-to-case thermal resistance
- RoHS compliant

2.3 Applications

The MSC130SM120JCU3 device is designed for the following applications:

- AC and DC motor control
- Switched mode power supplies

3 Electrical Specifications

This section shows the specifications of the MSC130SM120JCU3 device.

3.1 SiC MOSFET Characteristics

The following table shows the absolute maximum ratings of MSC130SM120JCU3 device.

Table 1 • Absolute Maximum Ratings

Symbol	Parameters	Maximum Ratings	Unit
V_{DSS}	Drain–source voltage	1200	V
I_D	Continuous drain current	$T_C = 25^\circ\text{C}$	173 ¹
		$T_C = 80^\circ\text{C}$	138 ¹
I_{DM}	Pulsed drain current	350	
V_{GS}	Gate–source voltage	–10/25	V
$R_{DS(on)}$	Drain–source ON resistance	16	m Ω
P_D	Power dissipation	$T_C = 25^\circ\text{C}$	745

Note:

1. Specification of SiC MOSFET device but output current must be limited due to the size of power connectors.

The following table shows the electrical characteristics of MSC130SM120JCU3 device.

Table 2 • Electrical Characteristics

Symbol	Characteristics	Test Conditions	Min	Typ	Max	Unit
I_{DSS}	Zero gate voltage drain current	$V_{GS} = 0\text{ V}; V_{DS} = 1200\text{ V}$		20	200	μA
$R_{DS(on)}$	Drain–source on resistance	$V_{GS} = 20\text{ V}$ $I_D = 80\text{ A}$	$T_C = 25^\circ\text{C}$	12.5	16	m Ω
			$T_C = 175^\circ\text{C}$	20		
$V_{GS(th)}$	Gate threshold voltage	$V_{GS} = V_{DS}, I_D = 2\text{ mA}$	1.8	2.8		V
I_{GSS}	Gate–source leakage current	$V_{GS} = 20\text{ V}, V_{DS} = 0\text{ V}$			200	nA

The following table shows the dynamic characteristics of MSC130SM120JCU3 device.

Table 3 • Dynamic Characteristics

Symbol	Characteristics	Test Conditions	Min	Typ	Max	Unit
C_{iss}	Input capacitance	$V_{GS} = 0\text{ V}$ $V_{DS} = 1000\text{ V}$ $f = 1\text{ MHz}$		6040		pF
C_{oss}	Output capacitance			540		
C_{rss}	Reverse transfer capacitance			50		
Q_g	Total gate charge	$V_{GS} = -5/20\text{ V}$ $V_{Bus} = 800\text{ V}$ $I_D = 80\text{ A}$		464		nC
Q_{gs}	Gate–source charge			82		
Q_{gd}	Gate–drain charge			100		
$T_{d(on)}$	Turn-on delay time	$V_{GS} = -5/20\text{ V}$ $V_{Bus} = 600\text{ V}$ $I_D = 100\text{ A}$ $R_{Gon} = 4\ \Omega$ $R_{Goff} = 2.4\ \Omega$		30		ns
T_r	Rise time			30		
$T_{d(off)}$	Turn-off delay time			50		
T_f	Fall time			25		
E_{on}	Turn on energy	Inductive Switching $V_{GS} = -5/20\text{ V}$ $V_{Bus} = 600\text{ V}$ $I_D = 100\text{ A}$ $R_{Gon} = 4\ \Omega$ $R_{Goff} = 2.4\ \Omega$	$T_J = 150^\circ\text{C}$	1.98		mJ
E_{off}	Turn off energy		$T_J = 150^\circ\text{C}$	1.3		mJ
R_{gint}	Internal gate resistance			2.94		Ω
R_{thJC}	Junction-to-case thermal resistance				0.2	$^\circ\text{C/W}$

The following table shows the body diode ratings and characteristics of MSC130SM120JCU3 device.

Table 4 • Body Diode Ratings and Characteristics

Symbol	Characteristics	Test Conditions	Min	Typ	Max	Unit
V_{SD}	Diode forward voltage	$V_{GS} = 0\text{ V} ; I_{SD} = 80\text{ A}$		4		V
		$V_{GS} = -5\text{ V} ; I_{SD} = 80\text{ A}$		4.2		
t_{rr}	Reverse recovery time	$I_{SD} = 80\text{ A} ;$ $V_{GS} = -5\text{ V}$ $V_R = 800\text{ V} ;$ $di_f/dt = 2000\text{ A}/\mu\text{s}$		90		ns
Q_{rr}	Reverse recovery charge			1100		nC
I_{rr}	Reverse recovery current			27		A

3.2 SiC Chopper Diode Ratings and Characteristics

The following table shows the SiC chopper diode ratings and characteristics of MSC130SM120JCU3 device.

Table 5 • SiC Chopper Diode Ratings and Characteristics

Symbol	Characteristics	Test Conditions	Min	Typ	Max	Unit
V_{RRM}	Peak repetitive reverse voltage				1200	V
I_{RM}	Reverse leakage current	$V_R = 1200\text{ V}$	$T_J = 25\text{ }^\circ\text{C}$	15	400	μA
			$T_J = 175\text{ }^\circ\text{C}$	250		
I_F	DC forward current			50		A
V_F	Diode forward voltage	$I_F = 50\text{ A}$	$T_J = 25\text{ }^\circ\text{C}$	1.5	1.8	V
			$T_J = 175\text{ }^\circ\text{C}$	2.1		
Q_C	Total capacitive charge	$V_R = 600\text{ V}$		224		nC
C	Total capacitance	$f = 1\text{ MHz}, V_R = 400\text{ V}$		246		pF
		$f = 1\text{ MHz}, V_R = 800\text{ V}$		182		
R_{thJC}	Junction-to-case thermal resistance				0.56	$^\circ\text{C/W}$

3.3 Thermal and Package Characteristics

The following table shows the thermal and package characteristics of MSC130SM120JCU3 device.

Table 6 • Thermal and Package Characteristics

Symbol	Characteristics	Min	Typ	Max	Unit
V_{ISOL}	RMS isolation voltage, any terminal to case $t = 1\text{ min}, 50/60\text{ Hz}$	2500			V
T_{STG}	Storage temperature range	-55		175	$^\circ\text{C}$
T_J	Operating junction temperature range	-55		175	
T_{JOP}	Recommended junction temperature under switching conditions	-55		$T_{Jmax} - 25$	
Torque	Terminals and mounting screws			1.1	N.m
Wt	Package weight		29.2		g

3.4 SiC MOSFET Performance Curves

This sections shows the typical SiC MOSFET performance curves of the MSC130SM120JCU3 device.

Figure 3 • Maximum Thermal Impedance

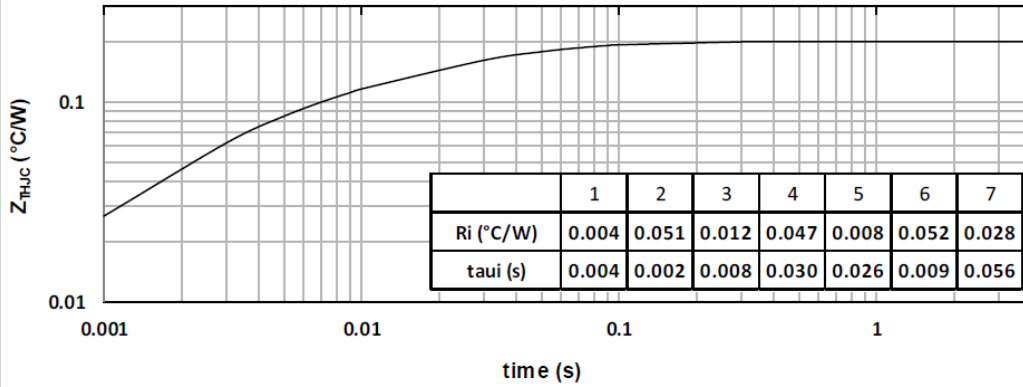

Figure 4 • Output Characteristics, T_J=25 °C

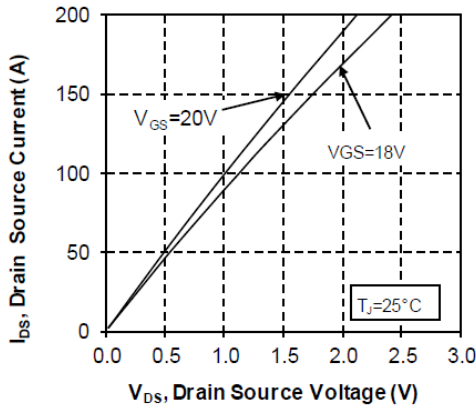

Figure 5 • Output Characteristics, T_J=175 °C

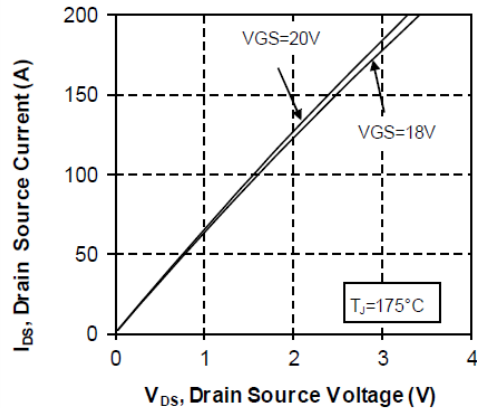

Figure 6 • Normalized R_{DS(on)} vs. Temperature

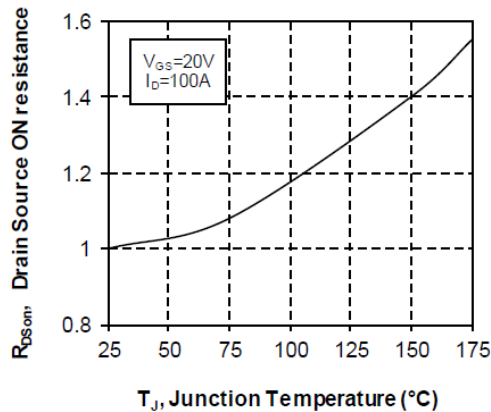

Figure 7 • Transfer Characteristics

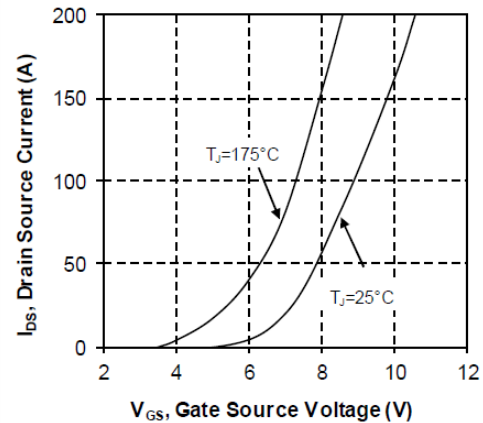

Figure 8 • Switching Energy vs. Rg

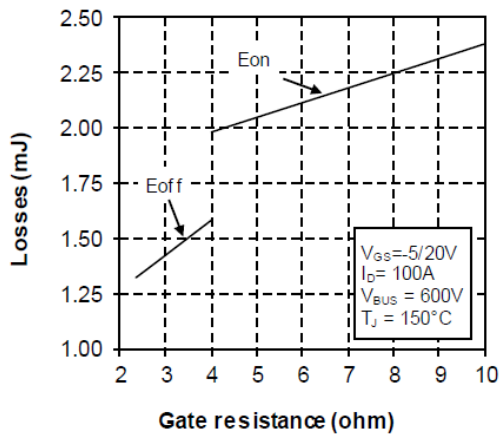

Figure 9 • Switching Energy vs. Current

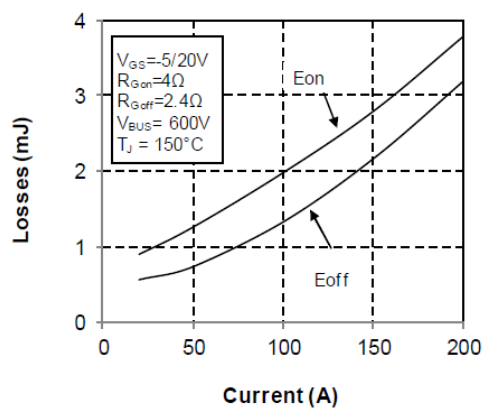

Figure 10 • Capacitance vs. Drain Source Voltage

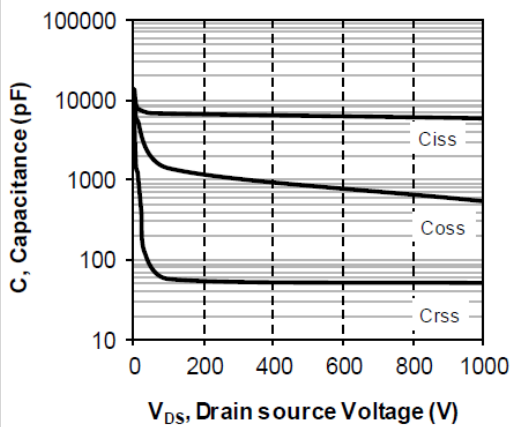

Figure 11 • Gate Charge vs. Gate Source Voltage

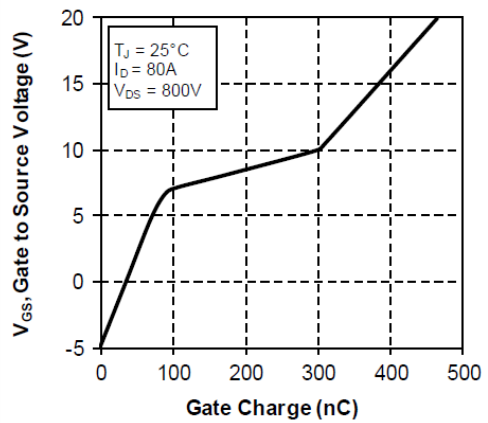

Figure 12 • Body Diode Characteristics, TJ=25 °C

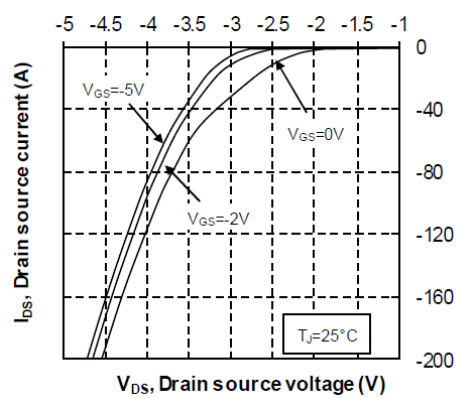

Figure 13 • 3rd Quadrant Characteristics, TJ=25 °C

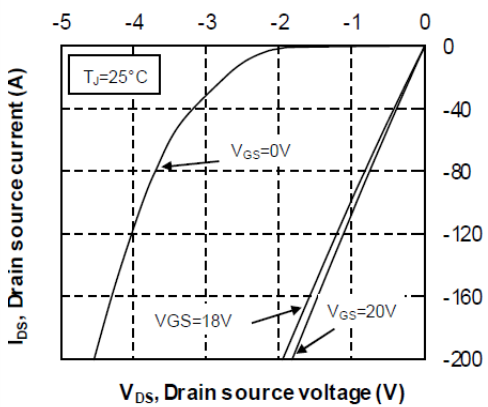

Figure 14 • Body Diode Characteristics, $T_J=175^\circ\text{C}$

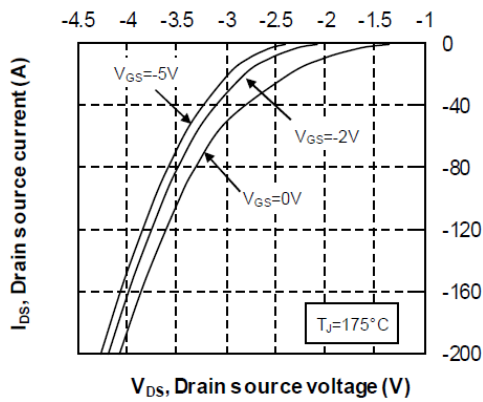

Figure 15 • 3rd Quadrant Characteristics, $T_J=175^\circ\text{C}$

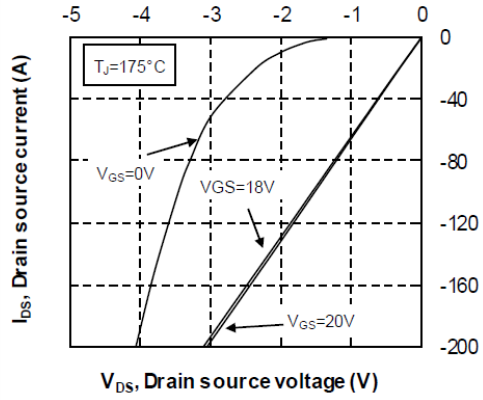
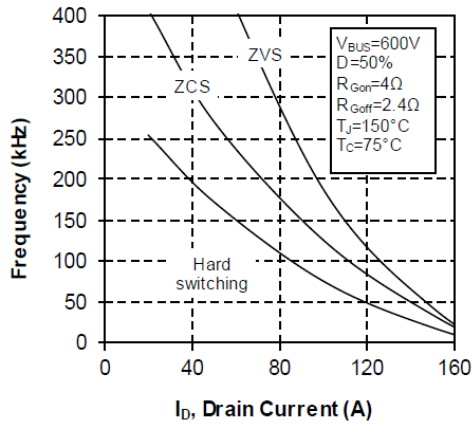

Figure 16 • Operating Frequency vs. Drain Current



3.5 Typical SiC Diode Performance Curves

This sections shows the typical SiC diode performance curves of the MSC130SM120JCU3 device.

Figure 17 • Maximum Thermal Impedance

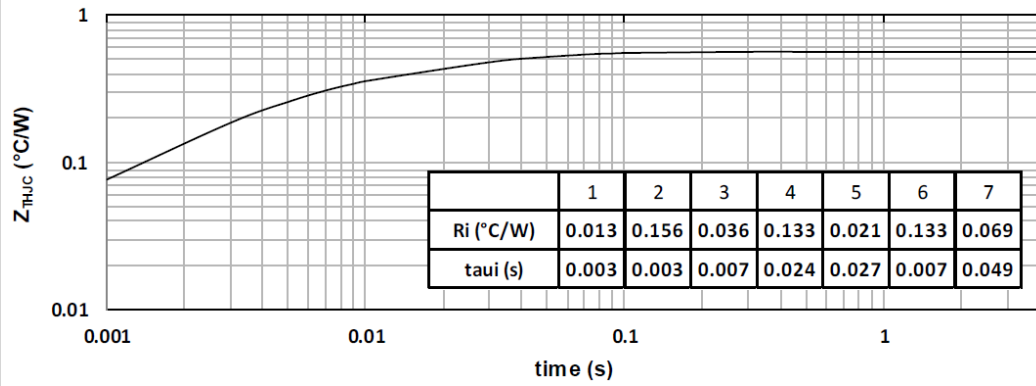

Figure 18 • Forward Characteristics

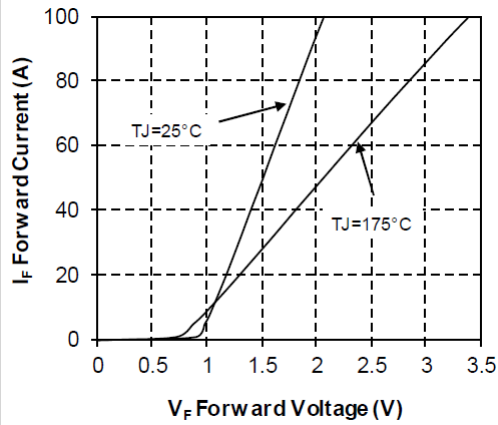
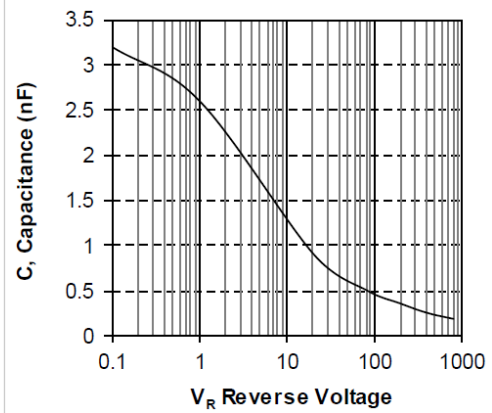

Figure 19 • Capacitance vs. Reverse Voltage



4 Package Specifications

This section shows the package specification of the MSC130SM120JCU3 device.

4.1 Package Outline Drawing

The following figure illustrates the package outline of the MSC130SM120JCU3 device. The dimensions are in millimeters and (inches).

Figure 20 • Package Outline Drawing

