

MSCSM120AM03CT6LIAG

Datasheet

**Very Low Stray Inductance Phase Leg SiC
MOSFET Power Module**

January 2020



a  **MICROCHIP** company

Contents

Revision History.....	1
1.1 Revision 1.0.....	1
Product Overview.....	2
2.1 Features.....	3
2.2 Benefits.....	3
2.3 Applications.....	3
Electrical Specifications.....	4
3.1 SiC MOSFET Characteristics (Per MOSFET).....	4
3.2 SiC Diode Characteristics (Per SiC Diode).....	6
3.3 Thermal and Package Characteristics.....	7
3.4 SiC MOSFET Performance Curves.....	8
3.5 SiC Diode Performance Curves.....	11
Package Outline.....	12
4.1 Package Outline Drawing.....	12

1 Revision History

The revision history describes the changes that were implemented in the document. The changes are listed by revision, starting with the most current publication.

1.1 Revision 1.0

Revision 1.0 was published in January 2020. It is the first publication of this document.

2 Product Overview

The MSCSM120AM03CT6LIAG device is a 1200 V, 805 A full Silicon Carbide power module.

Figure 1 • Electrical Schematic of MSCSM120AM03CT6LIAG Device

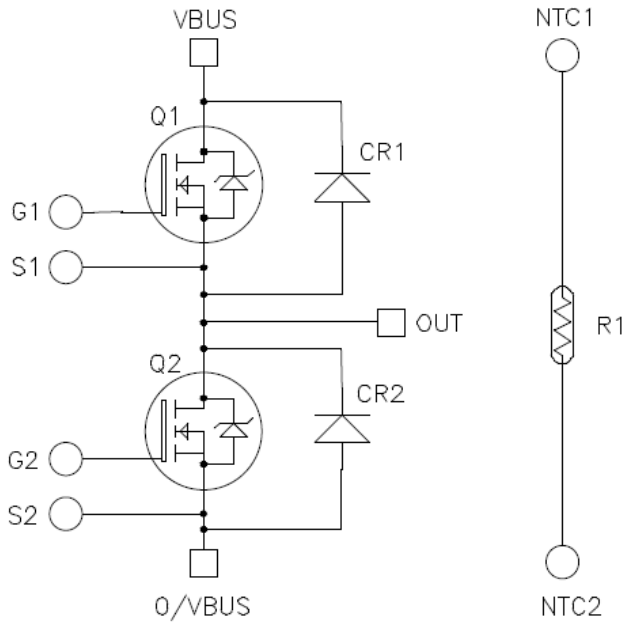
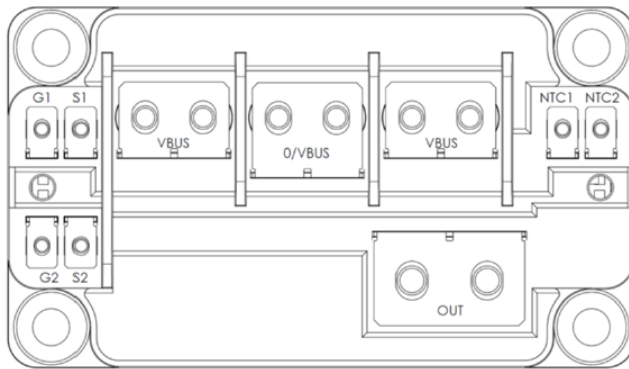

Figure 2 • Pinout Location



All ratings at $T_j = 25\text{ }^\circ\text{C}$, unless otherwise specified.

Caution: These devices are sensitive to electrostatic discharge. Proper handling procedures should be followed.

2.1 Features

The following are the features of MSCSM120AM03CT6LIAG device:

- SiC power MOSFET
 - Low $R_{DS(on)}$
 - High temperature performance
- SiC Schottky diode
 - Zero reverse recovery
 - Zero forward recovery
 - Temperature independent switching behavior
 - Positive temperature coefficient on VF
- Very low stray inductance
- Internal thermistor for temperature monitoring
- M4 and M5 power connectors
- M2.5 signals connectors
- AlN substrate for improved thermal performance

2.2 Benefits

The following are the benefits of MSCSM120AM03CT6LIAG device:

- High efficiency converter
- Outstanding performance at high frequency operation
- Direct mounting to heatsink (isolated package)
- Low junction-to-case thermal resistance
- Low profile
- RoHS compliant

2.3 Applications

The following are the applications of MSCSM120AM03CT6LIAG device:

- Welding converters
- Switched mode power supplies
- Uninterruptible power supplies
- EV motor and traction drive

3 Electrical Specifications

This section provides the electrical specifications for the MSCSM120AM03CT6LIAG device.

3.1 SiC MOSFET Characteristics (Per MOSFET)

The following table shows the absolute maximum ratings of MSCSM120AM03CT6LIAG device.

Table 1 • Absolute Maximum Ratings

Symbol	Parameters	Maximum Ratings	Unit	
V_{DSS}	Drain–source voltage	1200	V	
I_D	Continuous drain current	$T_C = 25^\circ\text{C}$	805 ¹	A
		$T_C = 80^\circ\text{C}$	640 ¹	
I_{DM}	Pulsed drain current	1600		
V_{GS}	Gate–source voltage	–10/25	V	
$R_{DS(on)}$	Drain–source ON resistance	3.1	m Ω	
P_D	Power dissipation	$T_C = 25^\circ\text{C}$	3215	W

Note:

1. Specification of SiC MOSFET device but output current must be limited due to size of power connectors.

The following table shows the electrical characteristics of MSCSM120AM03CT6LIAG device.

Table 2 • Electrical Characteristics

Symbol	Characteristics	Test Conditions	Min	Typ	Max	Unit
I_{DSS}	Zero gate voltage drain current	$V_{GS} = 0\text{ V}$; $V_{DS} = 1200\text{ V}$		150	1000	μA
$R_{DS(on)}$	Drain–source on resistance	$V_{GS} = 20\text{ V}$ $I_D = 400\text{ A}$	$T_C = 25^\circ\text{C}$	2.5	3.1	m Ω
			$T_C = 175^\circ\text{C}$	4		
$V_{GS(th)}$	Gate threshold voltage	$V_{GS} = V_{DS}$, $I_D = 10\text{ mA}$	1.8	2.8		V
I_{GSS}	Gate–source leakage current	$V_{GS} = 20\text{ V}$, $V_{DS} = 0\text{ V}$			1	μA

The following table shows the dynamic characteristics of MSCSM120AM03CT6LIAG device.

Table 3 • Dynamic Characteristics

Symbol	Characteristics	Test Conditions	Min	Typ	Max	Unit
C_{iss}	Input capacitance	$V_{GS} = 0\text{ V}$ $V_{DS} = 1000\text{ V}$ $f = 1\text{ MHz}$		30.2		nF
C_{oss}	Output capacitance			2.7		
C_{rss}	Reverse transfer capacitance			0.25		
Q_g	Total gate charge	$V_{GS} = -5/20\text{ V}$ $V_{Bus} = 800\text{ V}$ $I_D = 400\text{ A}$		2320		nC
Q_{gs}	Gate–source charge			410		
Q_{gd}	Gate–drain charge			500		
$T_{d(on)}$	Turn-on delay time	$V_{GS} = -5/20\text{ V}$ $T_J = 150\text{ }^\circ\text{C}$ $V_{Bus} = 600\text{ V}$ $I_D = 500\text{ A}$ $R_G = 0.3\ \Omega$		56		ns
T_r	Rise time			55		
$T_{d(off)}$	Turn-off delay time			166		
T_f	Fall time			67		
E_{on}	Turn on energy	Inductive switching $T_J = 150\text{ }^\circ\text{C}$ $V_{GS} = -5/20\text{ V}$ $V_{Bus} = 600\text{ V}$ $I_D = 500\text{ A}$ $R_G = 0.3\ \Omega$		9.2		mJ
E_{off}	Turn off energy			8.3		
R_{Gint}	Internal gate resistance			0.98		Ω
R_{thJC}	Junction-to-case thermal resistance				0.047	$^\circ\text{C/W}$

The following table shows the body diode ratings and characteristics of MSCSM120AM03CT6LIAG device.

Table 4 • Body Diode Ratings and Characteristics

Symbol	Characteristics	Test Conditions	Min	Typ	Max	Unit
V_{SD}	Diode forward voltage	$V_{GS} = 0\text{ V};$ $I_{SD} = 400\text{ A}$		4		V
		$V_{GS} = -5\text{ V};$ $I_{SD} = 400\text{ A}$		4.2		
t_{rr}	Reverse recovery time	$I_{SD} = 400\text{ A};$ $V_{GS} = -5\text{ V}$ $V_R = 800\text{ V};$ $di_F/dt = 10000\text{ A}/\mu\text{s}$		90		ns
Q_{rr}	Reverse recovery charge			5.5		μC
I_{rr}	Reverse recovery current				135	

3.2 SiC Diode Characteristics (Per SiC Diode)

The following table shows the SiC diode characteristics (per SiC diode) of MSCSM120AM03CT6LIAG device.

Table 5 • SiC Diode Characteristics (Per SiC Diode)

Symbol	Characteristics	Test Conditions	Min	Typ	Max	Unit
V_{RRM}	Peak repetitive reverse voltage				1200	V
I_{RM}	Reverse leakage current	$V_R = 1200\text{ V}$	$T_J = 25\text{ °C}$	0.08	1	mA
			$T_J = 175\text{ °C}$	1.25		
I_F	DC forward current		$T_C = 95\text{ °C}$	250		A
V_F	Diode forward voltage	$I_F = 250\text{ A}$	$T_J = 25\text{ °C}$	1.5	1.8	V
			$T_J = 175\text{ °C}$	2.1		
Q_C	Total capacitive charge	$V_R = 600\text{ V}$		1120		nC
C	Total capacitance	$f = 1\text{ MHz}, V_R = 400\text{ V}$		1230		pF
		$f = 1\text{ MHz}, V_R = 800\text{ V}$		910		
R_{thJC}	Junction-to-case thermal resistance				0.126	°C/W

3.3 Thermal and Package Characteristics

The following table shows the package characteristics of MSCSM120AM03CT6LIAG device.

Table 6 • Package Characteristics

Symbol	Characteristics		Min	Max	Unit	
V _{ISOL}	RMS isolation voltage, any terminal to case t =1 min, 50/60 Hz		4000		V	
T _J	Operating junction temperature range		-40	175	°C	
T _{JOP}	Recommended junction temperature under switching conditions		-40	T _{Jmax} -25		
T _{STG}	Storage temperature range		-40	125		
T _C	Operating case temperature		-40	125		
Torque	Mounting torque	For terminals	M2.5	0.4	0.6	N.m
			M4	2	3	
			M5	2	3.5	
		To heatsink	M6	3	5	
L _{DC}	Module stray inductance between V _{BUS} and 0/V _{BUS}			3	nH	
Wt	Package weight			320	g	

The following table shows the temperature sensor NTC of MSCSM120AM03CT6LIAG device.

Table 7 • Temperature Sensor NTC

Symbol	Characteristics		Min	Typ	Max	Unit
R ₂₅	Resistance at 25°C			50		kΩ
ΔR ₂₅ /R ₂₅				5		%
B _{25/85}	T ₂₅ = 298.15 K			3952		K
ΔB/B	T _C = 100°C			4		%

$$R_T = \frac{R_{25}}{\exp\left[B_{25/85}\left(\frac{1}{T_{25}} - \frac{1}{T}\right)\right]}$$

T: Thermistor temperature
R_T: Thermistor value at T

3.4 SiC MOSFET Performance Curves

The following images show the SiC MOSFET performance curves of the MSCSM120AM03CT6LIAG device.

Figure 3 • Maximum Thermal Impedance

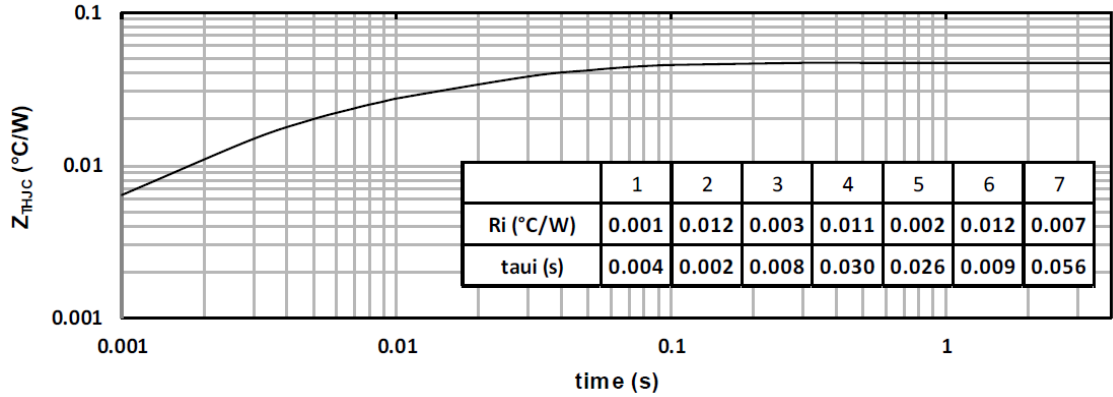

Figure 4 • Output Characteristics, T_J = 25 °C

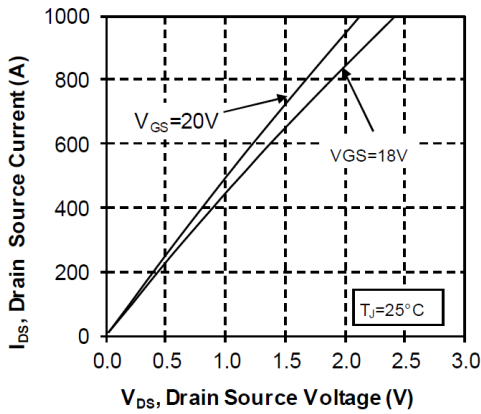

Figure 5 • Output Characteristics, T_J = 175 °C

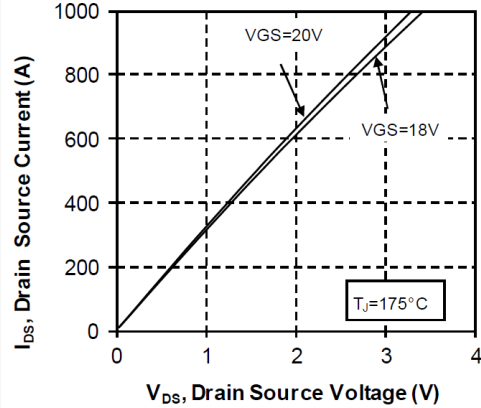

Figure 6 • Normalized R_{DS(on)} vs. Temperature

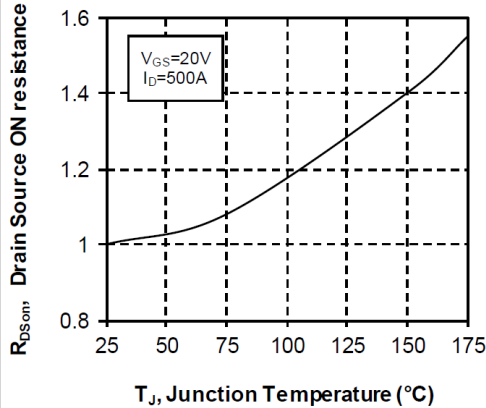

Figure 7 • Transfer Characteristics

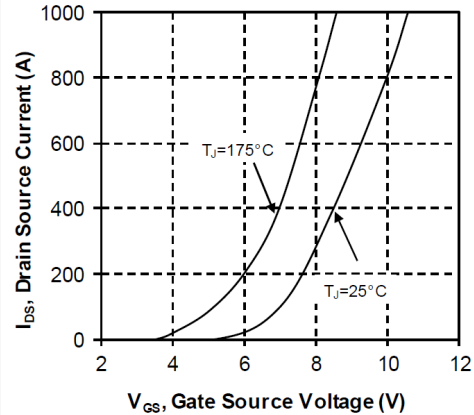

Figure 8 • Switching Energy vs. Rg

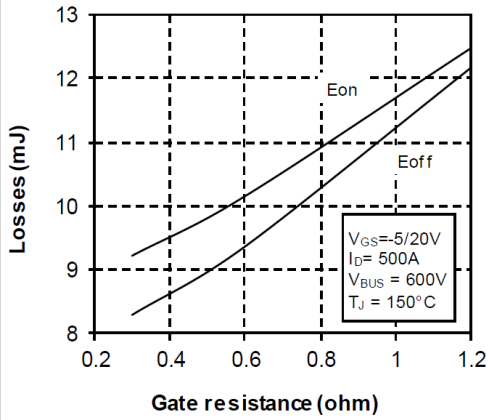

Figure 9 • Switching Energy vs. Current

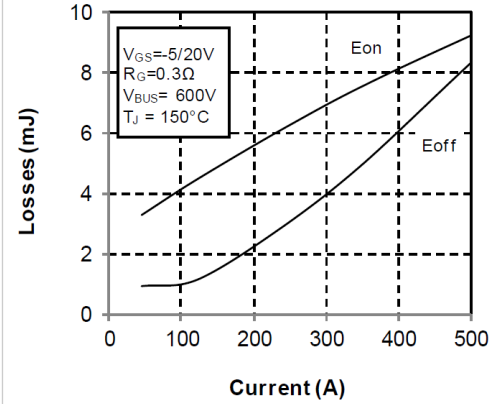

Figure 10 • Capacitance vs. Drain Source Voltage

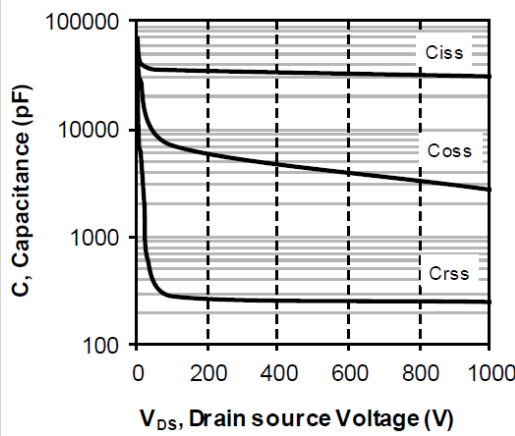

Figure 11 • Gate Charge vs. Gate Source Voltage

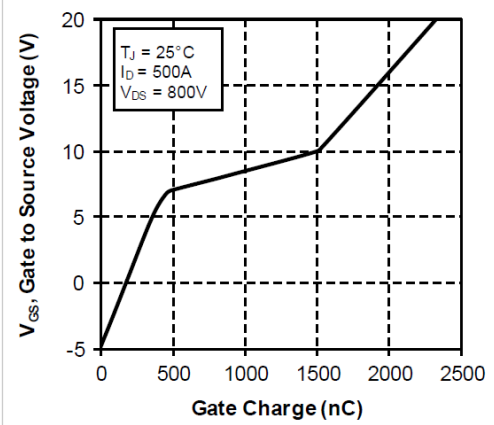

Figure 12 • Body Diode Characteristics, TJ=25 °C

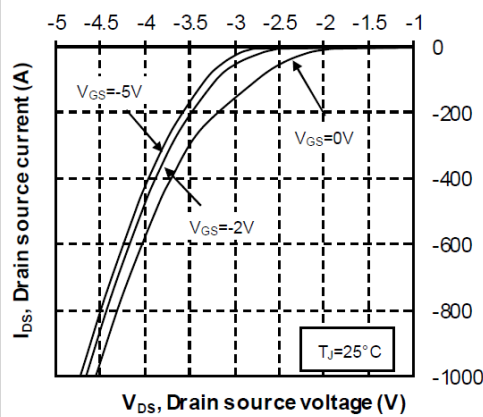

Figure 13 • 3rd Quadrant Characteristics, TJ=25 °C

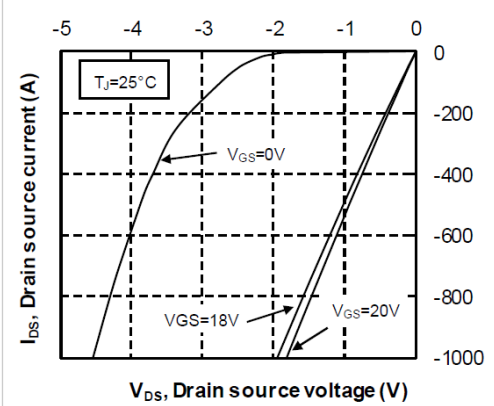

Figure 14 • Body Diode Characteristics, $T_J=175^\circ\text{C}$

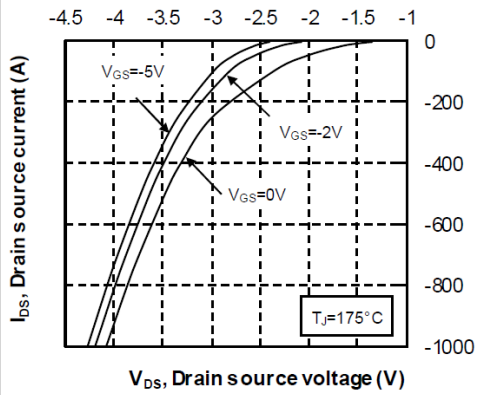

Figure 15 • 3rd Quadrant Characteristics, $T_J=175^\circ\text{C}$

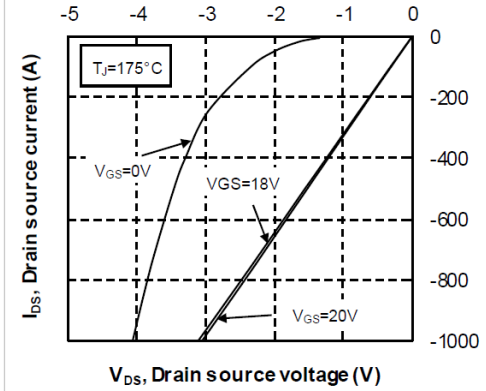
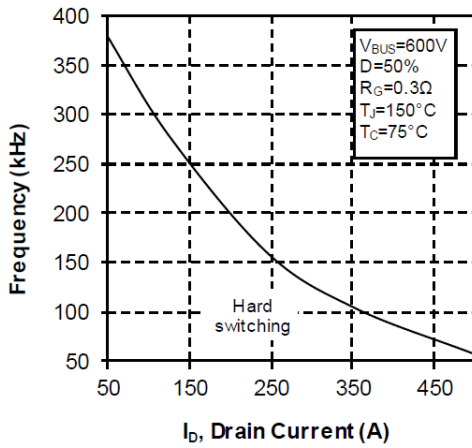

Figure 16 • Operating Frequency vs. Drain Current



3.5 SiC Diode Performance Curves

The following images show the SiC diode performance curves of MSCSM120AM03CT6LIAG device.

Figure 17 • Maximum Thermal Impedance

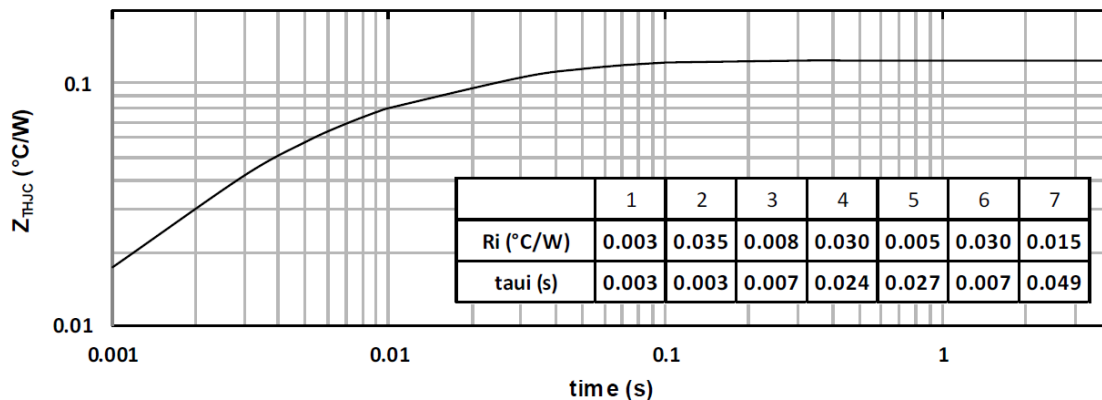

Figure 18 • Forward Characteristics

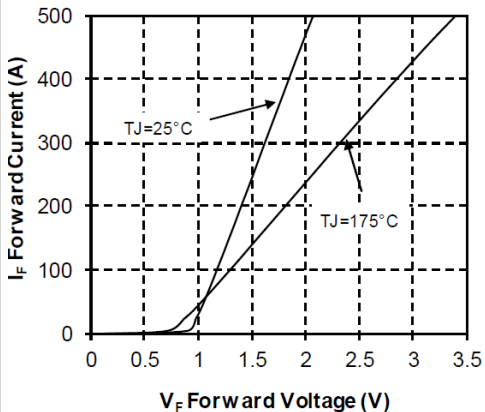
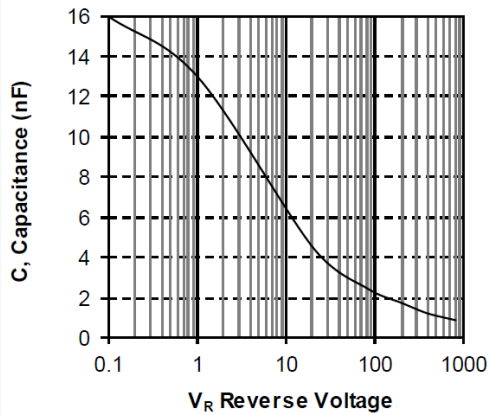

Figure 19 • Capacitance vs. Reverse Voltage



4 Package Specification

The following section shows the package specification of MSCSM120AM03CT6LIAG device.

4.1 Package Outline Drawing

The following image illustrates the package outline drawing of MSCSM120AM03CT6LIAG device. The dimensions are in millimeters.

Figure 20 • Package Outline Drawing

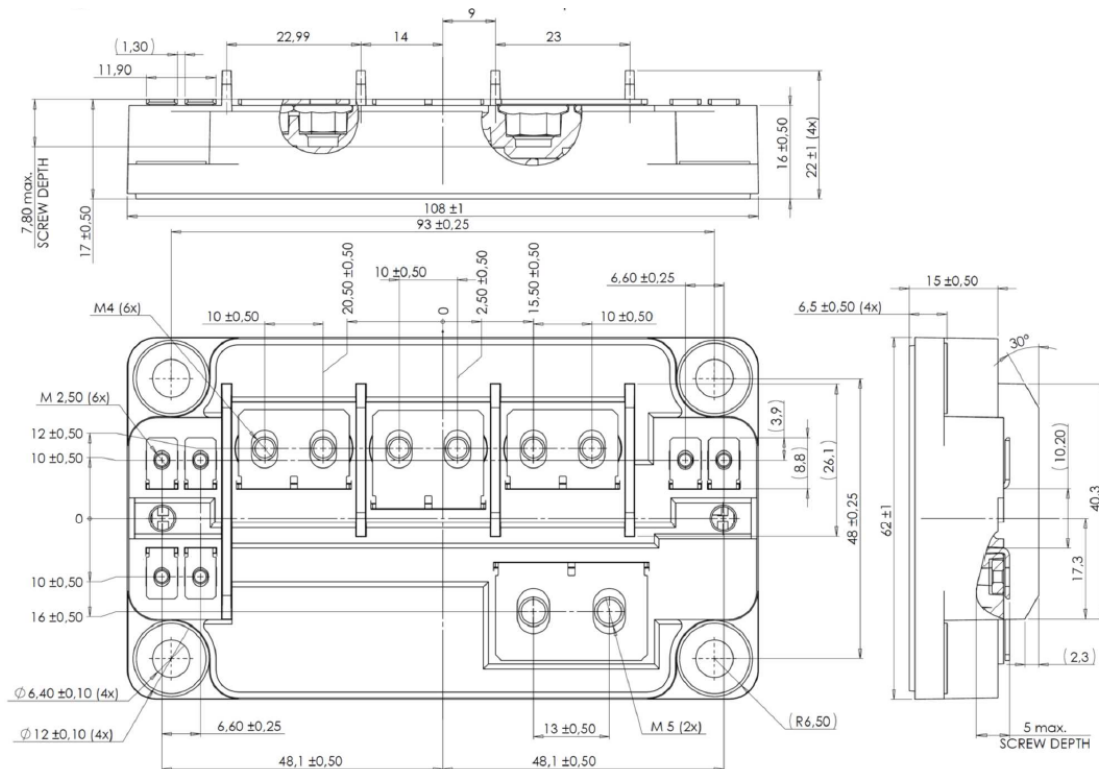

Note:

See [AN1911—Mounting instructions for SP6 Low inductance Power Module](#) application note.