

MSCSM120DAM11CT3AG
Datasheet
Boost Chopper SiC MOSFET Power Module

January 2020



a  **MICROCHIP** company

Contents

Revision History.....	1
1.1 Revision 1.0.....	1
Product Overview.....	2
2.1 Features.....	3
2.2 Benefits.....	3
2.3 Applications.....	3
Electrical Specifications.....	4
SiC MOSFET Characteristics (Per MOSFET).....	4
3.2 SiC Schottky Diode Ratings and Characteristics.....	6
3.3 Thermal and Package Characteristics.....	6
3.4 Typical SiC MOSFET Performance Curves.....	8
3.5 Typical SiC Diode Performance Curves.....	11
Package Specification.....	12
Package Outline Drawing.....	12

1 Revision History

The revision history describes the changes that were implemented in the document. The changes are listed by revision, starting with the most current publication.

1.1 Revision 1.0

Revision 1.0 was published in January 2020. It is the first publication of this document.

2 Product Overview

The MSCSM120DAM11CT3AG device is a boost chopper 1200 V/254 A full Silicon Carbide (SiC) power module.

Figure 1 • MSCSM120DAM11CT3AG Electrical Schematic

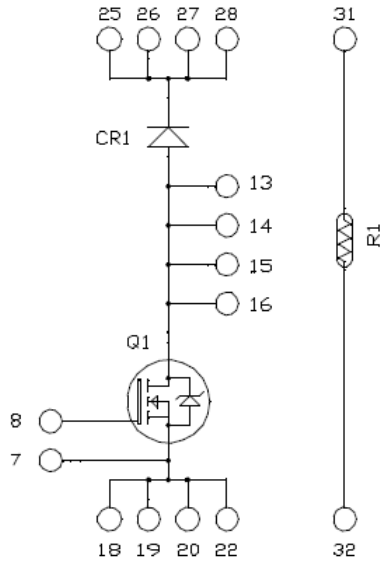
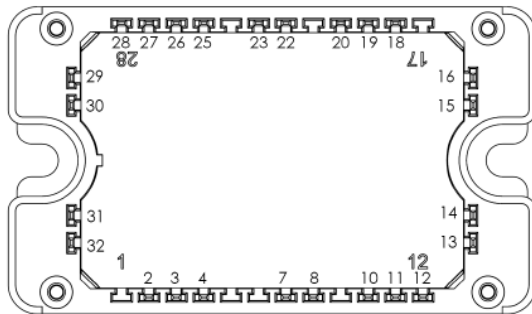

Figure 2 • MSCSM120DAM11CT3AG Pinout Location



Pins 25 to 28 must be shorted together
 Pins 13 to 16 must be shorted together
 Pins 18/19/20/22 must be shorted together

All ratings at $T_j = 25\text{ }^\circ\text{C}$, unless otherwise specified.

Caution: These devices are sensitive to electrostatic discharge. Proper handling procedures should be followed.

2.1 Features

The following are key features of the MSCSM120DAM11CT3AG device:

- SiC Power MOSFET
 - High speed switching
 - Low $R_{DS(on)}$
 - Ultra low loss
- SiC Schottky Diode
 - Zero reverse recovery
 - Zero forward recovery
 - Temperature Independent switching behavior
 - Positive temperature coefficient on VF
- Low stray inductance
- Kelvin source for easy drive
- Internal thermistor for temperature monitoring
- Aluminum nitride (AlN) substrate for improved thermal performance

2.2 Benefits

The following are benefits of the MSCSM120DAM11CT3AG device:

- High efficiency converter
- Outstanding performance at high frequency operation
- Direct mounting to heatsink (isolated package)
- Low junction-to-case thermal resistance
- Solderable terminals for power and signal, for easy PCB mounting
- Low profile
- RoHS compliant

2.3 Applications

The MSCSM120DAM11CT3AG device is designed for the following applications:

- Induction heating and welding
- Solar inverter
- Uninterruptible power supplies

3 Electrical Specifications

This section shows the electrical specifications of the MSCSM120DAM11CT3AG device.

3.1 SiC MOSFET Characteristics (Per MOSFET)

The following table shows the absolute maximum ratings per MOSFET of the MSCSM120DAM11CT3AG device.

Table 1 • Absolute Maximum Ratings

Symbol	Parameter	Max Ratings	Unit
V_{DSS}	Drain-source voltage	1200	V
I_D	Continuous drain current	$T_C = 25\text{ }^\circ\text{C}$	254 ¹
		$T_C = 80\text{ }^\circ\text{C}$	202 ¹
I_{DM}	Pulsed drain current	500	
V_{GS}	Gate-source voltage	-10/25	V
$R_{DS(on)}$	Drain-source ON resistance	10.4	m Ω
P_D	Power dissipation	$T_C = 25\text{ }^\circ\text{C}$	1067

Note:

1. Specification of SiC MOSFET device, but output current must be limited due to size of power connectors.

The following table shows the electrical characteristics per MOSFET of the MSCSM120DAM11CT3AG device.

Table 2 • Electrical Characteristics

Symbol	Characteristic	Test Conditions	Min	Typ	Max	Unit
I_{DSS}	Zero gate voltage drain current	$V_{GS} = 0\text{ V}$; $V_{DS} = 1200\text{ V}$		30	300	μA
$R_{DS(on)}$	Drain-source on resistance	$V_{GS} = 20\text{ V}$ $I_D = 120\text{ A}$	$T_J = 25\text{ }^\circ\text{C}$	8.4	10.4	m Ω
			$T_J = 175\text{ }^\circ\text{C}$	13.4		
$V_{GS(th)}$	Gate threshold voltage	$V_{GS} = V_{DS}$, $I_D = 3\text{ mA}$	1.8	2.8		V
I_{GSS}	Gate-source leakage current	$V_{GS} = 20\text{ V}$, $V_{DS} = 0\text{ V}$			300	nA

The following table shows the dynamic characteristics per MOSFET of the MSCSM120DAM11CT3AG device.

Table 3 • Dynamic Characteristics

Symbol	Characteristic	Test Conditions	Min	Typ	Max	Unit
C_{iss}	Input capacitance	$V_{GS} = 0\text{ V}$ $V_{DS} = 1000\text{ V}$ $f = 1\text{ MHz}$		9060		pF
C_{oss}	Output capacitance			810		
C_{rss}	Reverse transfer capacitance			75		
Q_g	Total gate charge	$V_{GS} = -5\text{ V}/20\text{ V}$ $V_{BUS} = 800\text{ V}$ $I_D = 120\text{ A}$		696		nC
Q_{gs}	Gate-source charge			123		
Q_{gd}	Gate-drain charge			150		
$T_{d(on)}$	Turn-on delay time	$V_{GS} = -5\text{ V}/20\text{ V}$ $V_{BUS} = 600\text{ V}$ $I_D = 150\text{ A}$ $R_{Gon} = 2.7\ \Omega$; $R_{Goff} = 1.6\ \Omega$		30		ns
T_r	Rise time			30		
$T_{d(off)}$	Turn-off delay time			50		
T_f	Fall time			25		
E_{on}	Turn on energy	Inductive switching $V_{GS} = -5\text{ V}/20\text{ V}$	$T_j = 150\text{ }^\circ\text{C}$	3.0		mJ
E_{off}	Turn off energy	$V_{BUS} = 600\text{ V}$ $I_D = 150\text{ A}$ $R_{Gon} = 2.7\ \Omega$ $R_{Goff} = 1.6\ \Omega$	$T_j = 150\text{ }^\circ\text{C}$	2.0		mJ
R_{Gint}	Internal gate resistance			2.0		Ω
R_{thJC}	Junction-to-case thermal resistance				0.141	$^\circ\text{C}/\text{W}$

The following table shows the body diode ratings and characteristics per MOSFET of the MSCSM120DAM11CT3AG device.

Table 4 • Body Diode Ratings and Characteristics

Symbol	Characteristic	Test Conditions	Min	Typ	Max	Unit
V_{SD}	Diode forward voltage	$V_{GS} = 0\text{ V}$; $I_{SD} = 120\text{ A}$		4.0		V
		$V_{GS} = -5\text{ V}$; $I_{SD} = 120\text{ A}$		4.2		
t_{rr}	Reverse recovery time	$I_{SD} = 120\text{ A}$; $V_{GS} = -5\text{ V}$ $V_R = 800\text{ V}$; $d_i/dt = 3000\text{ A}/\mu\text{s}$		90		ns
Q_{rr}	Reverse recovery charge			1650		nC
I_{rr}	Reverse recovery current				40.5	

3.2 SiC Schottky Diode Ratings and Characteristics

The following table shows the SiC Schottky diode ratings and characteristics of the MSCSM120DAM11CT3AG device.

Table 5 • SiC Schottky Diode Ratings and Characteristics

Symbol	Characteristic	Test Conditions		Min	Typ	Max	Unit
V_{RRM}	Peak repetitive reverse voltage					1200	V
I_{RM}	Reverse leakage current	$V_R = 1200\text{ V}$	$T_J = 25\text{ }^\circ\text{C}$	60	1200		μA
			$T_J = 175\text{ }^\circ\text{C}$	900			
I_F	DC forward current				180		A
V_F	Diode forward voltage	$I_F = 180\text{ A}$	$T_J = 25\text{ }^\circ\text{C}$	1.5	1.8		V
			$T_J = 175\text{ }^\circ\text{C}$	2.1			
QC	Total capacitive charge	$V_R = 600\text{ V}$			780		nC
C	Total capacitance	$f = 1\text{ MHz}, V_R = 400\text{ V}$			846		pF
		$f = 1\text{ MHz}, V_R = 800\text{ V}$			630		
R_{thJC}	Junction-to-case thermal resistance					0.175	$^\circ\text{C/W}$

3.3 Thermal and Package Characteristics

The following table shows the package characteristics of the MSCSM120DAM11CT3AG device.

Table 6 • Package Characteristics

Symbol	Characteristic		Min	Max	Unit	
V_{ISOL}	RMS isolation voltage, any terminal to case $t = 1\text{ min}$, 50 Hz/60 Hz		4000		V	
T_J	Operating junction temperature range		-40	175	$^\circ\text{C}$	
T_{JOP}	Recommended junction temperature under switching conditions		-40	$T_{Jmax} - 25$		
T_{STG}	Storage temperature range		-40	125		
T_C	Operating case temperature		-40	125		
Torque	Mounting torque	To heatsink	M4	2	3	N.m
Wt	Package weight				110	g

The following table shows the temperature sensor NTC (see application note [APT0406](#) on www.microsemi.com) of the MSCSM120DAM11CT3AG device.

Table 7 • Temperature Sensor NTC

Symbol	Characteristic	Min	Typ	Max	Unit
R ₂₅	Resistance at 25 °C		50		kΩ
ΔR ₂₅ /R ₂₅			5		%
B _{25/85}	T ₂₅ = 298.15 K		3952		K
ΔB/B			4		%
					T _C = 100 °C

$$R_T = \frac{R_{25}}{\exp\left[B_{25/85}\left(\frac{1}{T_{25}} - \frac{1}{T}\right)\right]}$$

T: Thermistor temperature
 R_T: Thermistor value at T

3.4 Typical SiC MOSFET Performance Curves

This section shows the typical SiC MOSFET performance curves of the MSCSM120DAM11CT3AG device.

Figure 3 • Maximum Thermal Impedance

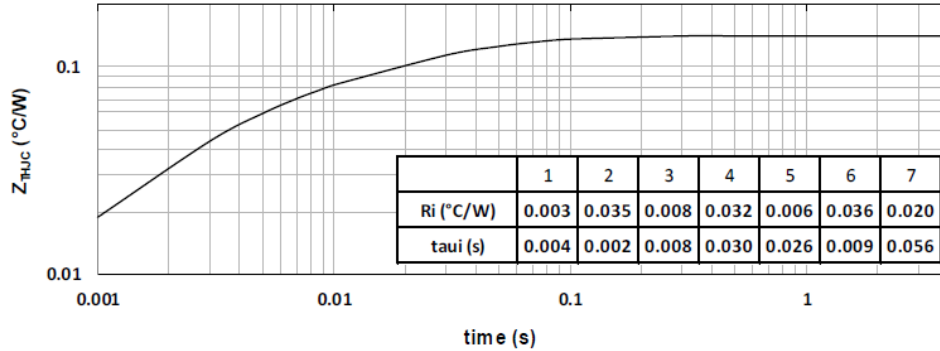

Figure 4 • Output Characteristics, T_J = 25 °C

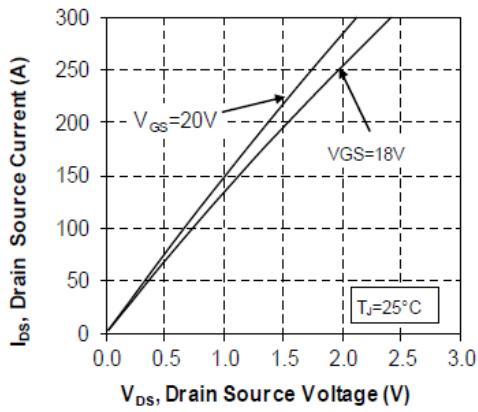

Figure 5 • Output Characteristics, T_J = 175 °C

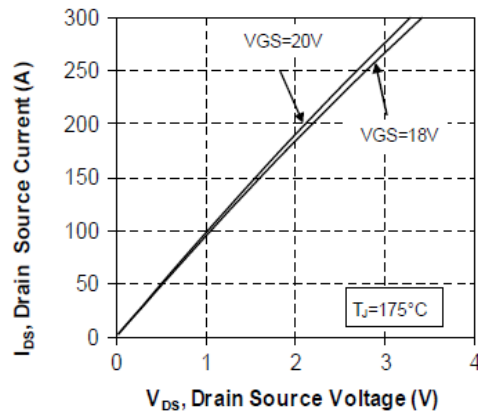

Figure 6 • Normalized R_{DS(on)} vs. Temperature

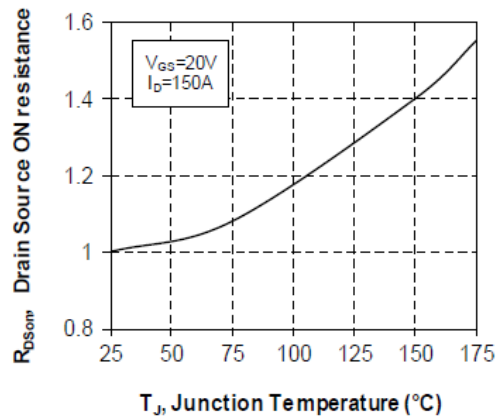

Figure 7 • Transfer Characteristics

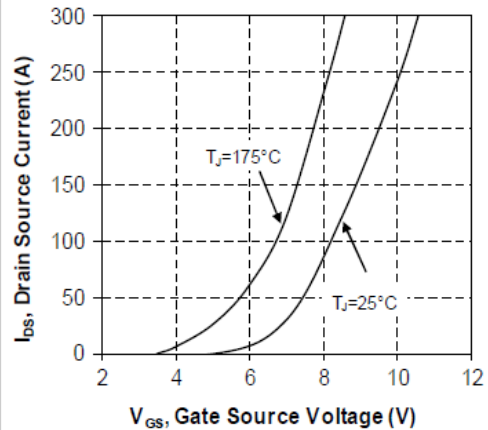

Figure 8 • Switching Energy vs. Rg

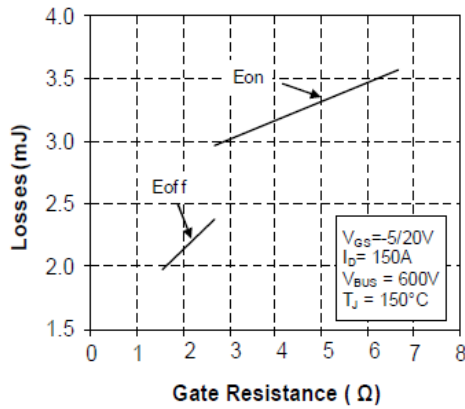

Figure 9 • Switching Energy vs. Current

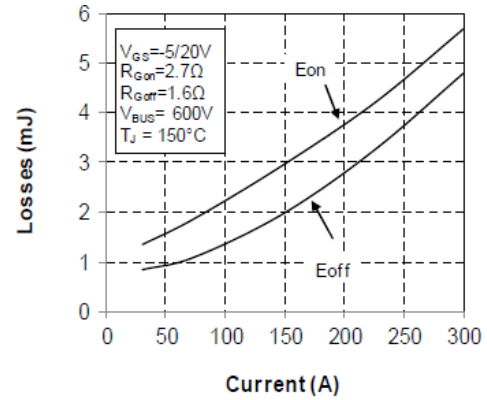

Figure 10 • Capacitance vs. Drain Source Voltage

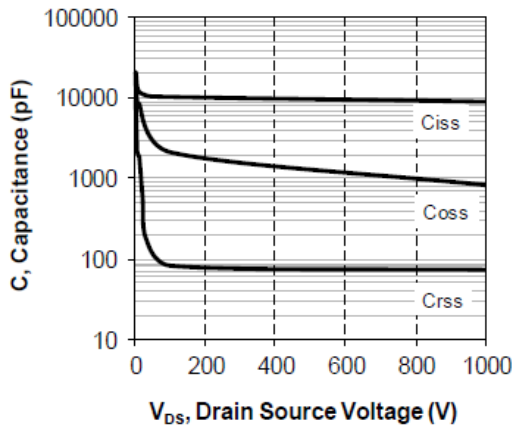

Figure 11 • Gate Charge vs. Gate Source Voltage

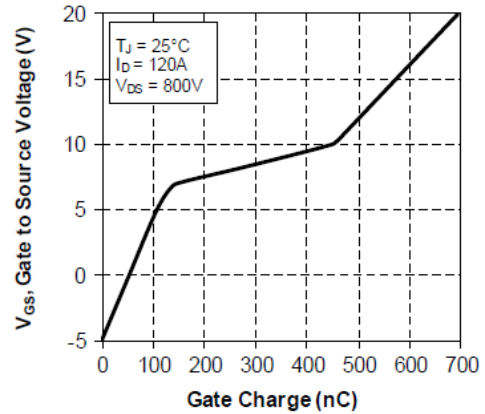

Figure 12 • Body Diode Characteristics, TJ = 25 °C

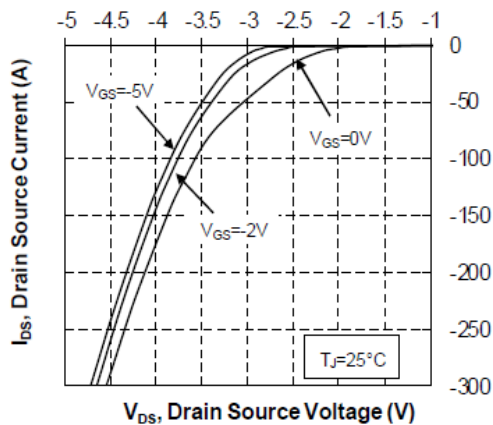

Figure 13 • 3rd Quadrant Characteristics, TJ = 25 °C

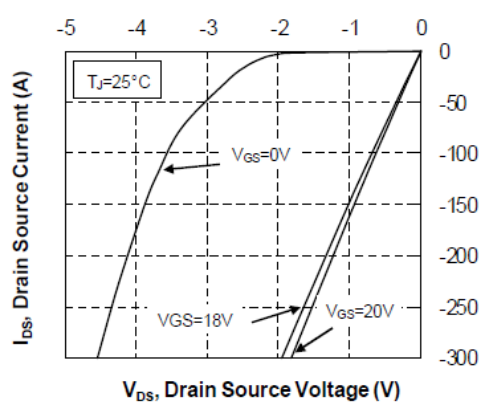

Figure 14 • Body Diode Characteristics, $T_J = 175^\circ\text{C}$

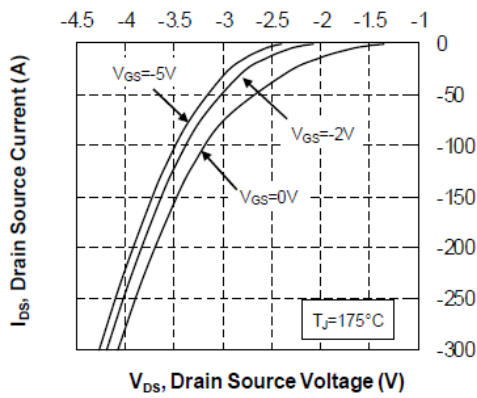

Figure 15 • 3rd Quadrant Characteristics, $T_J = 175^\circ\text{C}$

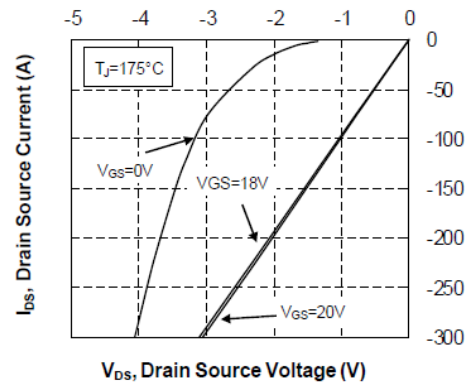
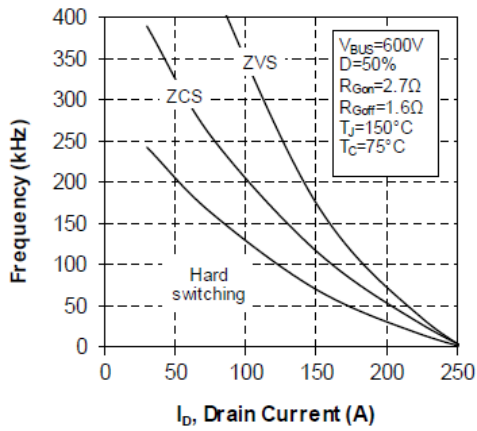

Figure 16 • Operating Frequency vs. Drain Current



3.5 Typical SiC Diode Performance Curves

This sections shows the typical SiC diode performance curves of the MSCSM120DAM11CT3AG device.

Figure 17 • Maximum Thermal Impedance

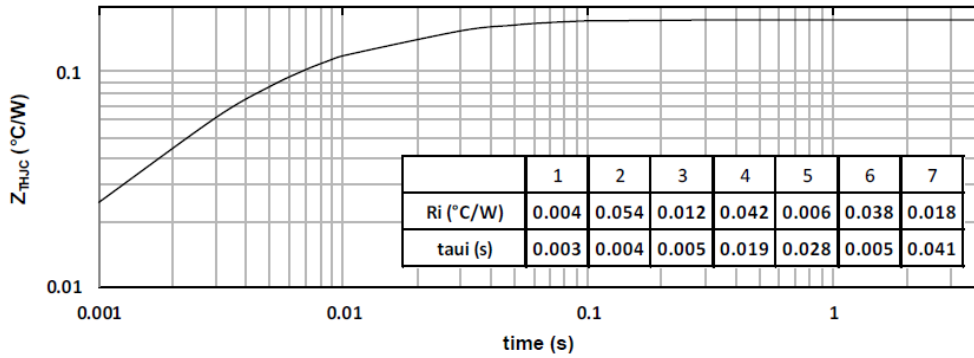

Figure 18 • Forward Characteristics

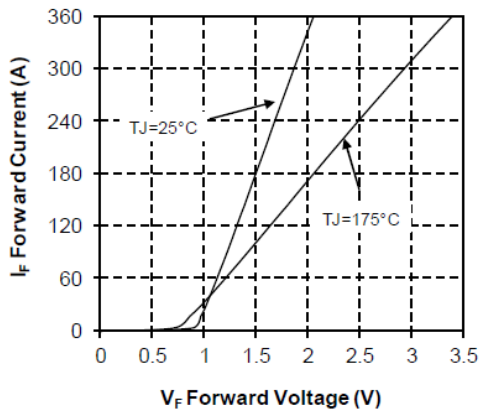
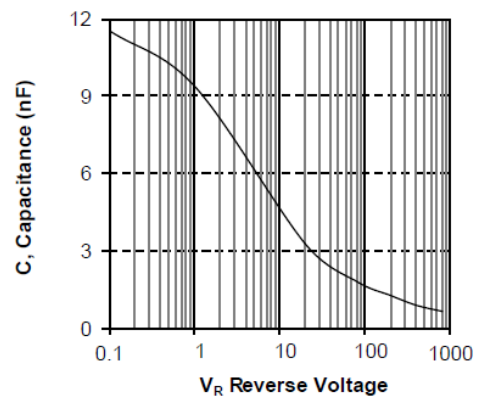

Figure 19 • Capacitance vs. Reverse Voltage



4 Package Specification

This section shows the package specification of the MSCSM120DAM11CT3AG device.

4.1 Package Outline Drawing

The following figure illustrates the package outline of the MSCSM120DAM11CT3AG device. The dimensions in the following figure are in millimeters.

Figure 20 • Package Outline Drawing

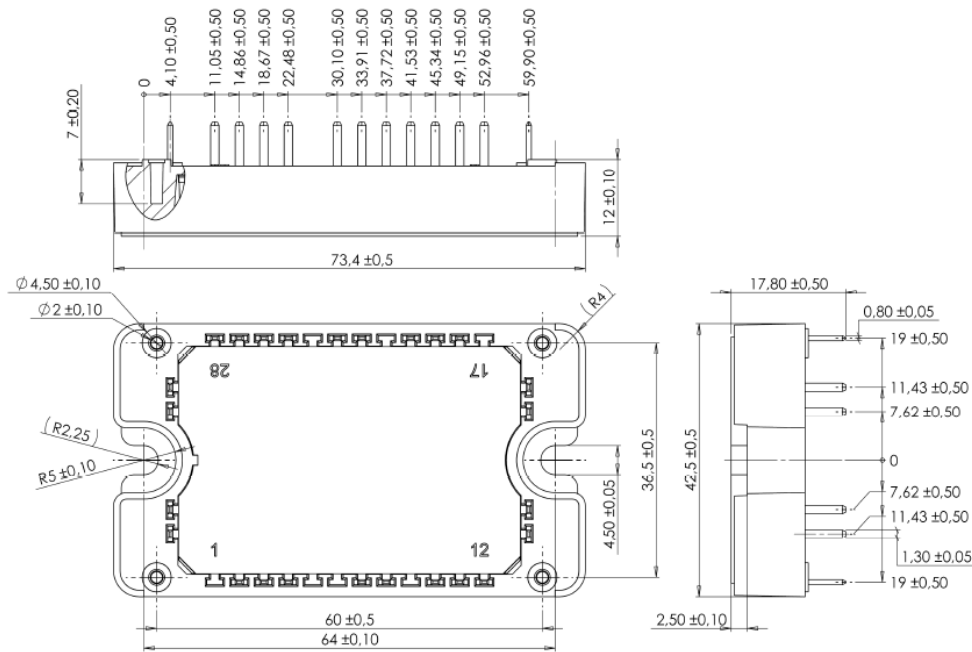

Note: See application note [1906—Mounting Instructions for SP3F Power Modules](#) at www.microsemi.com.