

**MSCSM120HM50CT3AG**  
**Datasheet**  
**Full Bridge SiC MOSFET Power Module**

January 2020



---

a  **MICROCHIP** company

# Contents

---

<b>Revision History</b> .....	<b>1</b>
1.1 Revision 1.0.....	1
<b>Product Overview</b> .....	<b>2</b>
2.1 Features.....	3
2.2 Benefits.....	3
2.3 Applications.....	3
<b>Electrical Specifications</b> .....	<b>4</b>
3.1 SiC MOSFET Characteristics (Per MOSFET).....	4
3.2 Reverse SiC Diode Ratings and Characteristics (Per SiC Diode).....	6
3.3 Thermal and Package Characteristics.....	6
3.4 Typical SiC MOSFET Performance Curves.....	8
3.5 Typical SiC Diode Performance Curves.....	11
<b>Package Specifications</b> .....	<b>12</b>
4.1 Package Outline Drawing.....	12

# 1 Revision History

---

The revision history describes the changes that were implemented in the document. The changes are listed by revision, starting with the most current publication.

## 1.1 Revision 1.0

Revision 1.0 was published in January 2020. It is the first publication of this document.

## 2 Product Overview

The MSCSM120HM50CT3AG device is a full bridge 1200 V/ 55 A full Silicon Carbide (SiC) power module.

**Figure 1 • MSCSM120HM50CT3AG Electrical Schematic**

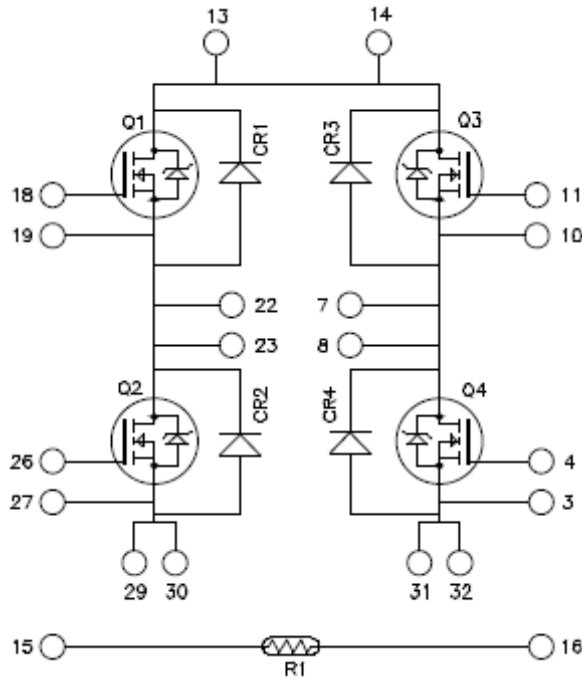

**Figure 2 • MSCSM120HM50CT3AG Pinout Location**

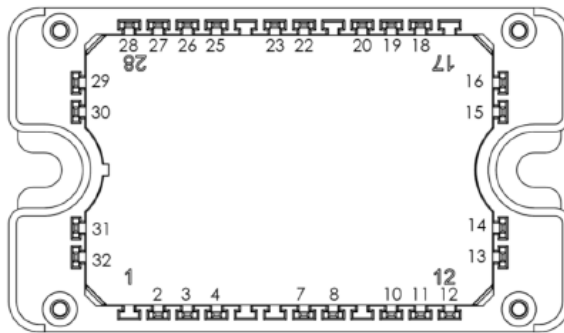

All multiple inputs and outputs must be shorted together. Example: 13/14 ; 29/30 ; 22/23, and so on.

All ratings at  $T_j = 25\text{ }^\circ\text{C}$ , unless otherwise specified.

**Caution:** These devices are sensitive to electrostatic discharge. Proper handling procedures should be followed.

## 2.1 Features

The following are key features of the MSCSM120HM50CT3AG device:

- SiC Power MOSFET
  - Low  $R_{DS(on)}$
  - High temperature performance
- SiC Schottky Diode
  - Zero reverse recovery
  - Zero forward recovery
  - Temperature independent switching behavior
  - Positive temperature coefficient on VF
- Very low stray inductance
- Internal thermistor for temperature monitoring
- Aluminum nitride (AlN) substrate for improved thermal performance

## 2.2 Benefits

The following are benefits of the MSCSM120HM50CT3AG device:

- High power and efficiency converters and inverters
- Outstanding performance at high frequency operation
- Direct mounting to heatsink (isolated package)
- Low junction-to-case thermal resistance
- Solderable terminals for power and signal, for easy PCB mounting
- Low profile
- RoHS compliant

## 2.3 Applications

The MSCSM120HM50CT3AG device is designed for the following applications:

- Uninterruptible power supplies
- Switched mode power supplies
- EV motor and traction drive
- Welding converters

## 3 Electrical Specifications

This section shows the electrical specifications of the MSCSM120HM50CT3AG device.

### 3.1 SiC MOSFET Characteristics (Per MOSFET)

The following table shows the absolute maximum ratings per MOSFET of the MSCSM120HM50CT3AG device.

**Table 1 • Absolute Maximum Ratings**

Symbol	Parameter	Max Ratings	Unit
$V_{DSS}$	Drain-source voltage	1200	V
$I_D$	Continuous drain current	$T_C = 25\text{ }^\circ\text{C}$	55
		$T_C = 80\text{ }^\circ\text{C}$	44
$I_{DM}$	Pulsed drain current	110	
$V_{GS}$	Gate-source voltage	-10/25	V
$R_{DS(on)}$	Drain source ON resistance	50	m $\Omega$
$P_D$	Power dissipation	$T_C = 25\text{ }^\circ\text{C}$	245

The following table shows the electrical characteristics per MOSFET of the MSCSM120HM50CT3AG device.

**Table 2 • Electrical Characteristics**

Symbol	Characteristic	Test Conditions	Min	Typ	Max	Unit
$I_{DSS}$	Zero gate voltage drain current	$V_{GS} = 0\text{ V}; V_{DS} = 1200\text{ V}$		10	100	$\mu\text{A}$
$R_{DS(on)}$	Drain-source on resistance	$V_{GS} = 20\text{ V}$ $I_D = 40\text{ A}$	$T_J = 25\text{ }^\circ\text{C}$		40	50
			$T_J = 175\text{ }^\circ\text{C}$		64	
$V_{GS(th)}$	Gate threshold voltage	$V_{GS} = V_{DS}, I_D = 1\text{ mA}$	1.8	2.7		V
$I_{GSS}$	Gate-source leakage current	$V_{GS} = 20\text{ V}, V_{DS} = 0\text{ V}$			150	nA

The following table shows the dynamic characteristics per MOSFET of the MSCSM120HM50CT3AG device.

**Table 3 • Dynamic Characteristics**

Symbol	Characteristic	Test Conditions	Min	Typ	Max	Unit
$C_{iss}$	Input capacitance	$V_{GS} = 0\text{ V}$ $V_{DS} = 1000\text{ V}$ $f = 1\text{ MHz}$		1990		pF
$C_{oss}$	Output capacitance			156		
$C_{rss}$	Reverse transfer capacitance			17		
$Q_g$	Total gate charge	$V_{GS} = -5\text{ V}/20\text{ V}$ $V_{Bus} = 800\text{ V}$ $I_D = 40\text{ A}$		137		nC
$Q_{gs}$	Gate–source charge			29		
$Q_{gd}$	Gate–drain charge			31		
$T_{d(on)}$	Turn-on delay time	$V_{GS} = -5\text{ V}/20\text{ V}$ $V_{Bus} = 600\text{ V}$ $I_D = 40\text{ A}$ $R_{Gon} = 10\ \Omega$ ; $R_{Goff} = 5.8\ \Omega$		30		ns
$T_r$	Rise time			30		
$T_{d(off)}$	Turn-off delay time			50		
$T_f$	Fall time			25		
$E_{on}$	Turn on energy	Inductive switching	$T_j = 150\text{ }^\circ\text{C}$	0.79		mJ
$E_{off}$	Turn off energy	$V_{GS} = -5\text{ V}/20\text{ V}$ $V_{Bus} = 600\text{ V}$ $I_D = 40\text{ A}$ $R_{Gon} = 10\ \Omega$ $R_{Goff} = 5.8\ \Omega$	$T_j = 150\text{ }^\circ\text{C}$	0.53		mJ
$R_{Gint}$	Internal gate resistance			1.2		$\Omega$
$R_{thJC}$	Junction-to-case thermal resistance				0.61	$^\circ\text{C}/\text{W}$

The following table shows the body diode ratings and characteristics per MOSFET of the MSCSM120HM31CT3AG device.

**Table 4 • Body Diode Ratings and Characteristics**

Symbol	Characteristic	Test Conditions	Min	Typ	Max	Unit
$V_{SD}$	Diode Forward Voltage	$V_{GS} = 0\text{ V}$ ; $I_{SD} = 40\text{ A}$		5.4		V
$t_{rr}$	Reverse recovery time	$I_{SD} = 40\text{ A}$ ; $V_{GS} = -5\text{ V}$ $V_R = 800\text{ V}$ ; $dI_F/dt = 1800\text{ A}/\mu\text{s}$		31		ns
$Q_{rr}$	Reverse recovery charge			610		nC
$I_{rr}$	Reverse recovery current			40		A

### 3.2 Reverse SiC Diode Ratings and Characteristics (Per SiC Diode)

The following table shows the reverse SiC diode ratings and characteristics per SiC diode of the MSCSM120HM50CT3AG device.

**Table 5 • Reverse SiC Diode Ratings and Characteristics (Per SiC Diode)**

Symbol	Characteristic	Test Conditions		Min	Typ	Max	Unit
$V_{RRM}$	Peak repetitive reverse voltage					1200	V
$I_{RM}$	Reverse leakage current	$V_R = 1200\text{ V}$	$T_J = 25\text{ °C}$	10	200		$\mu\text{A}$
			$T_J = 175\text{ °C}$	50			
$I_F$	DC forward current				15		A
$V_F$	Diode forward voltage	$I_F = 15\text{ A}$	$T_J = 25\text{ °C}$	1.5	1.8		V
			$T_J = 175\text{ °C}$	2			
QC	Total capacitive charge	$V_R = 600\text{ V}$			73		nC
C	Total capacitance	$f = 1\text{ MHz}, V_R = 400\text{ V}$			80		$\mu\text{F}$
		$f = 1\text{ MHz}, V_R = 800\text{ V}$			59		
$R_{thJC}$	Junction-to-case thermal resistance					1.55	$^{\circ}\text{C/W}$

### 3.3 Thermal and Package Characteristics

The following table shows the package characteristics of the MSCSM120HM50CT3AG device.

**Table 6 • Package Characteristics**

Symbol	Characteristic			Min	Max	Unit
$V_{ISOL}$	RMS isolation voltage, any terminal to case $t = 1\text{ min}$ , 50 Hz/60 Hz			4000		V
$T_J$	Operating junction temperature range			-40	175	$^{\circ}\text{C}$
$T_{JOP}$	Recommended junction temperature under switching conditions			-40	$T_{Jmax}-25$	
$T_{STG}$	Storage temperature range			-40	125	
$T_C$	Operating case temperature			-40	125	
Torque	Mounting torque	To heatsink	M4	2	3	N.m
Wt	Package weight				110	g



The following table shows the temperature sensor NTC (see application note [APT0406](#) on [www.microsemi.com](http://www.microsemi.com)) of the MSCSM120HM50CT3AG device.

**Table 7 • Temperature Sensor NTC**

Symbol	Characteristic	Min	Typ	Max	Unit
R <sub>25</sub>	Resistance at 25 °C		50		kΩ
ΔR <sub>25</sub> /R <sub>25</sub>			5		%
B <sub>25/85</sub>	T <sub>25</sub> = 298.15 K		3952		K
ΔB/B			4		%
	T <sub>C</sub> = 100 °C				

$$R_T = \frac{R_{25}}{\exp\left[B_{25/85}\left(\frac{1}{T_{25}} - \frac{1}{T}\right)\right]}$$

T: Thermistor temperature  
 R<sub>T</sub>: Thermistor value at T

### 3.4 Typical SiC MOSFET Performance Curves

This sections shows the typical SiC MOSFET performance curves of the MSCSM120HM50CT3AG device.

**Figure 3 • Maximum Thermal Impedance**

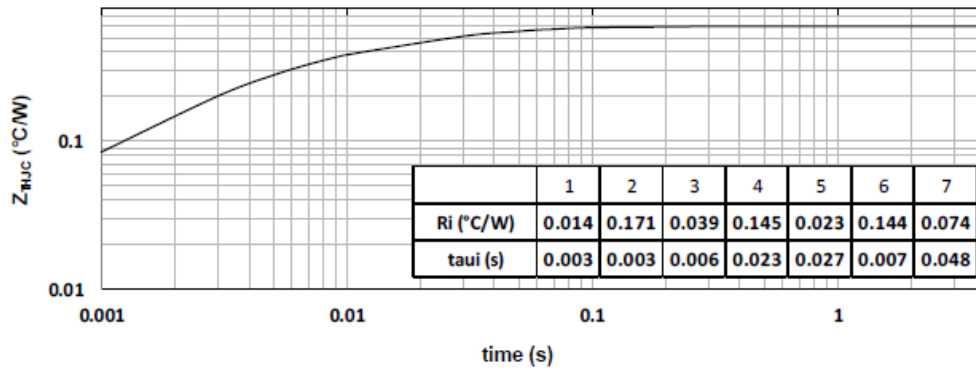

**Figure 4 • Output Characteristics,  $T_J = 25\text{ }^\circ\text{C}$**

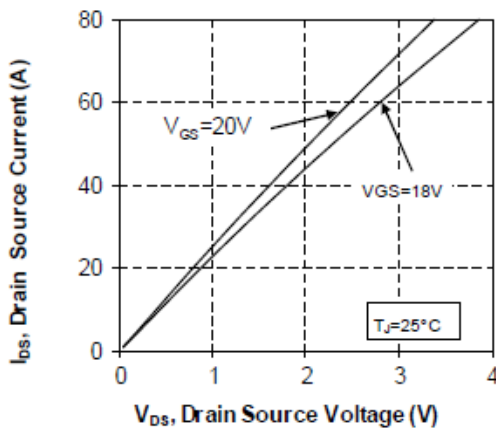

**Figure 5 • Output Characteristics,  $T_J = 175\text{ }^\circ\text{C}$**

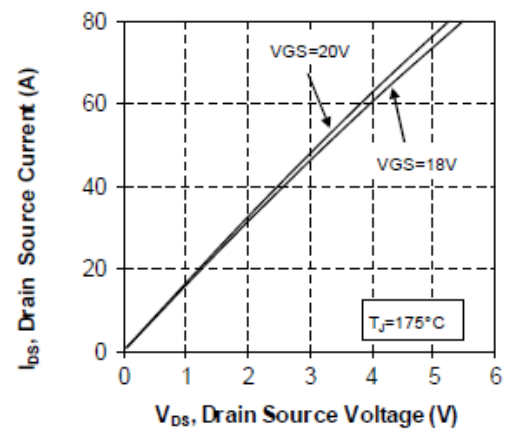

**Figure 6 • Normalized  $R_{DS(on)}$  vs. Temperature**

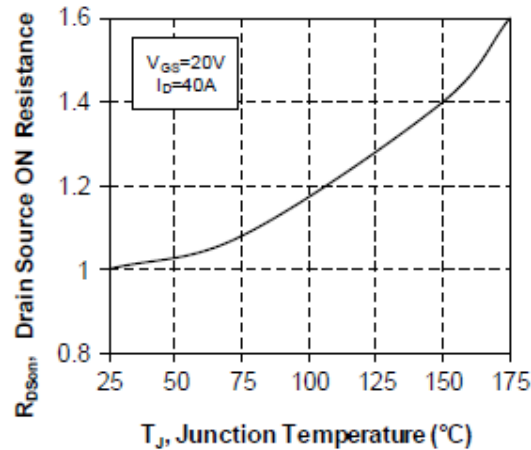

**Figure 7 • Transfer Characteristics**

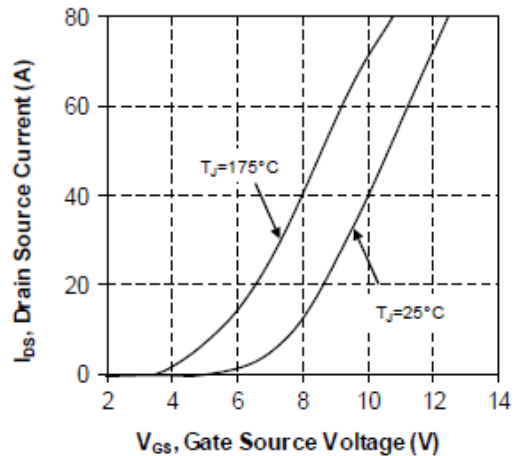

Figure 8 • Switching Energy vs. Rg

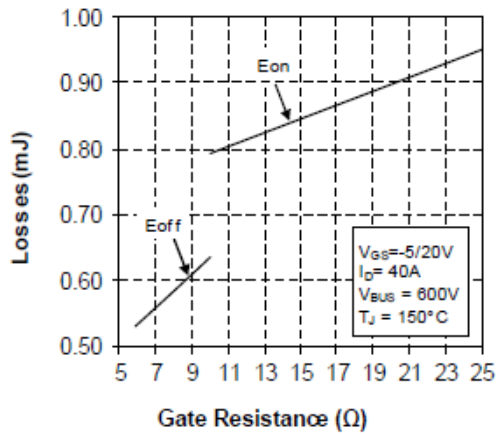

Figure 9 • Switching Energy vs. Current

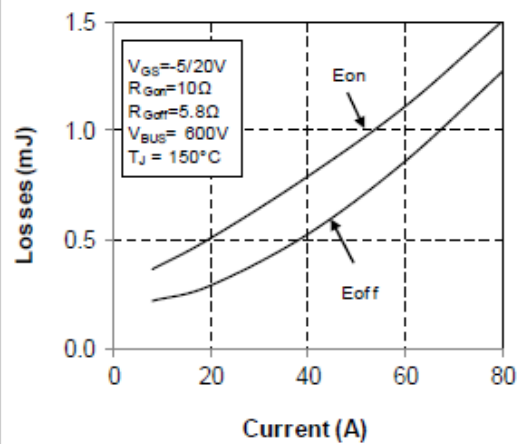

Figure 10 • Capacitance vs. Drain Source Voltage

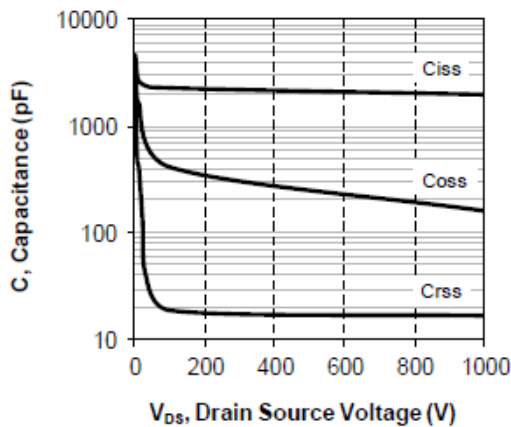

Figure 11 • Gate Charge vs. Gate Source Voltage

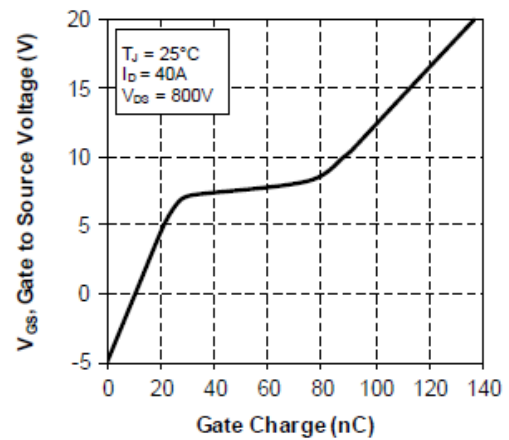

Figure 12 • Body Diode Characteristics, TJ = 25 °C

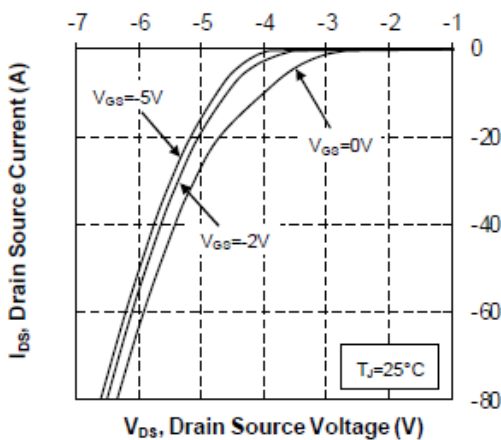

Figure 13 • 3<sup>rd</sup> Quadrant Characteristics, TJ = 25 °C

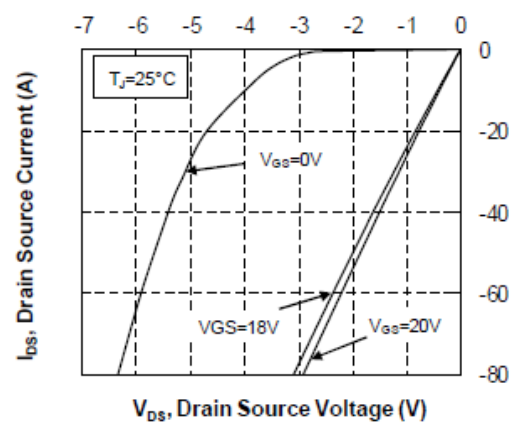

Figure 14 • Body Diode Characteristics,  $T_J = 175^\circ\text{C}$

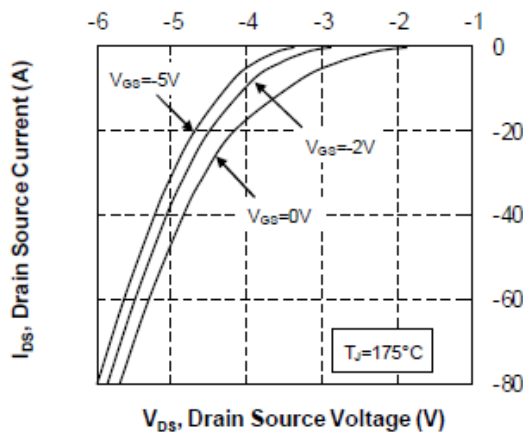

Figure 15 • 3<sup>rd</sup> Quadrant Characteristics,  $T_J = 175^\circ\text{C}$

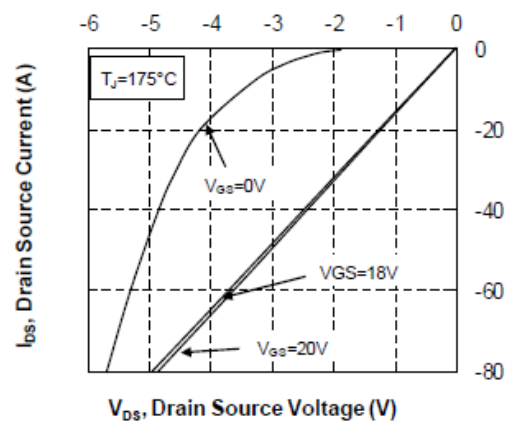
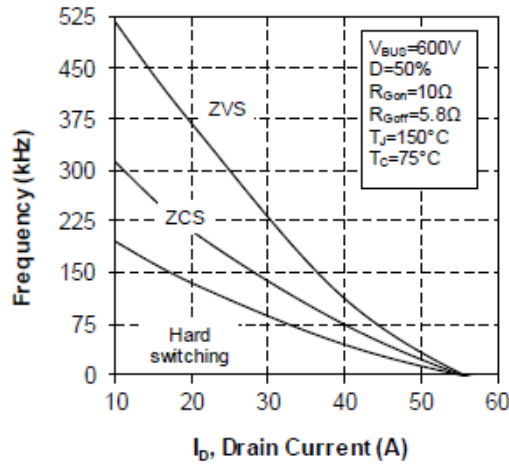

Figure 16 • Operating Frequency vs. Drain Current



### 3.5 Typical SiC Diode Performance Curves

This sections shows the typical SiC diode performance curves of the MSCSM120HM50CT3AG device.

**Figure 17 • Maximum Thermal Impedance**

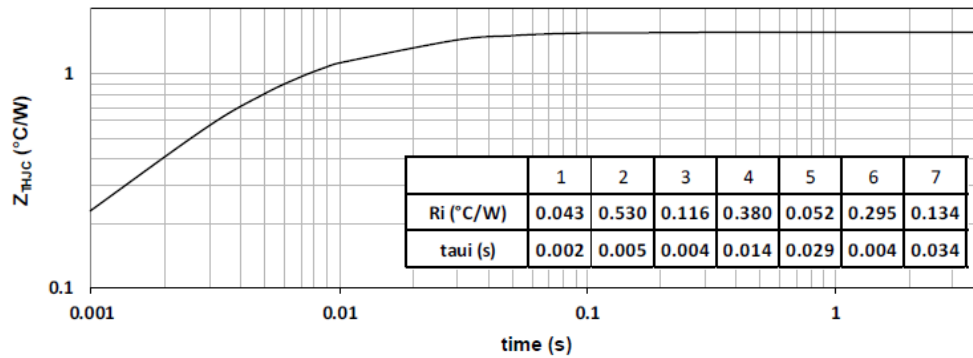

**Figure 18 • Forward Characteristics**

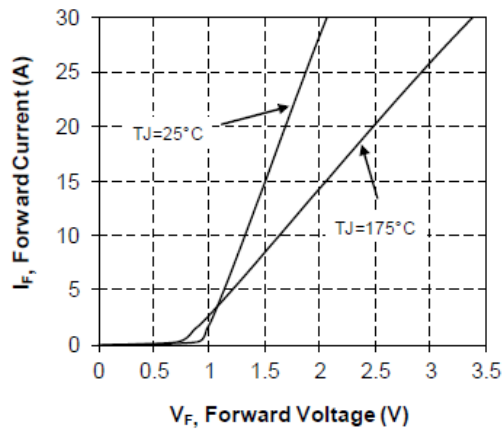

**Figure 19 • Capacitance vs. Reverse Voltage**

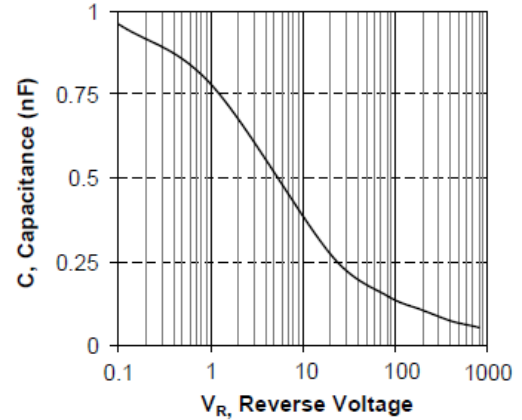

## 4 Package Specifications

This section shows the package specification of the MSCSM120HM50CT3AG device.

### 4.1 Package Outline Drawing

The following figure illustrates the package outline of the MSCSM120HM50CT3AG device. The dimensions are in millimeters.

Figure 20 • Package Outline Drawing

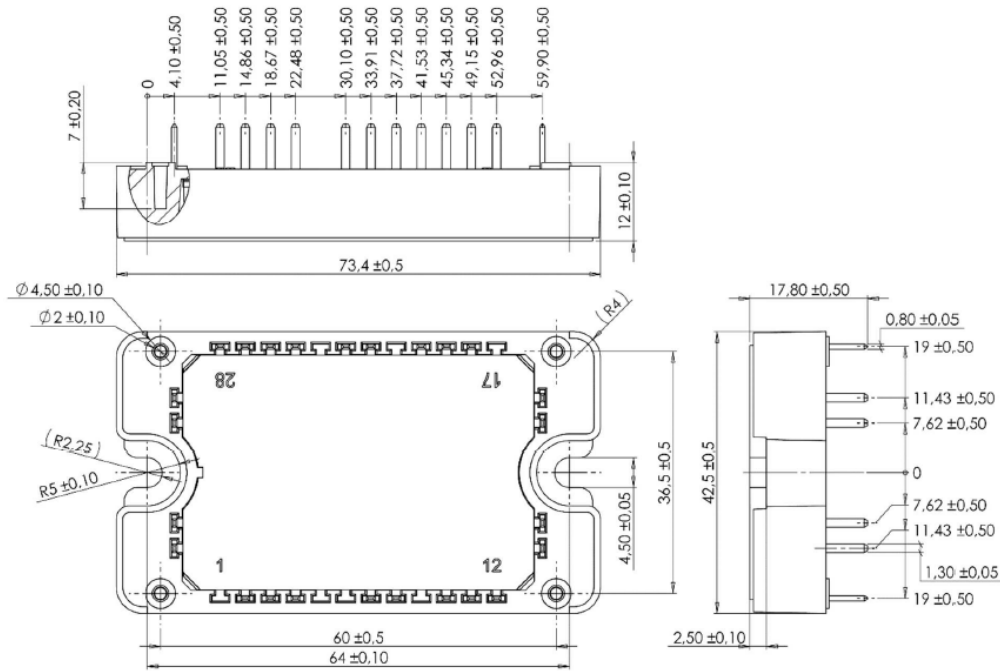

**Note:** See application note [1906—Mounting Instructions for SP3F Power Modules](#) on [www.microsemi.com](http://www.microsemi.com)