

## Full Bridge SiC Power Module

### Product Overview

The MSCSM70HM038AG device is a full bridge 700V, 464A silicon carbide (SiC) power module.

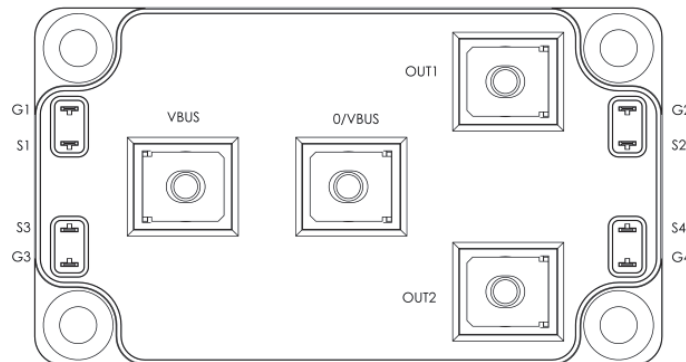
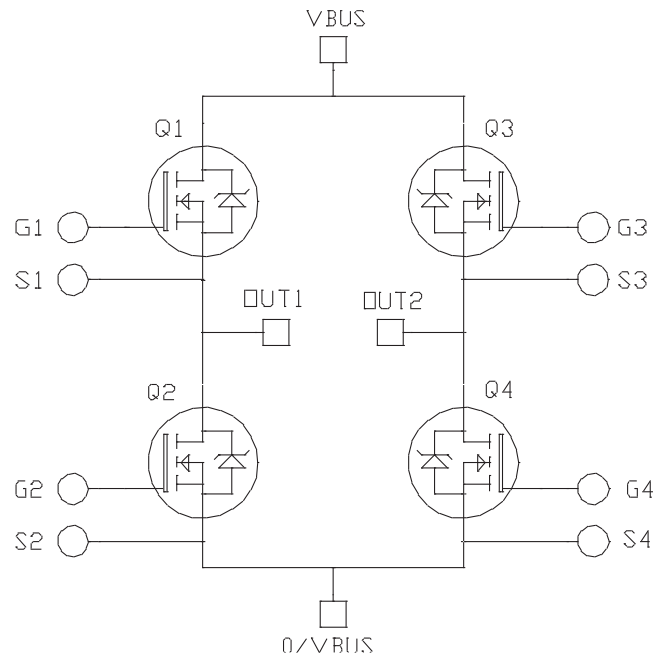

**Note:** All ratings at  $T_j = 25\text{ }^\circ\text{C}$ , unless otherwise specified.



These devices are sensitive to electrostatic discharge. Proper handling procedures must be followed.

## Features

---

The following are key features of the MSCSM70HM038AG device:

- SiC Power MOSFET
  - Low  $R_{DS(on)}$
  - High temperature performance
- Kelvin source for easy drive
- Low stray inductance
- M5 power connectors
- Aluminum Nitride (AlN) substrate for improved thermal performance

## Benefits

---

The following are the benefits of MSCSM70HM038AG device:

- High efficiency converter
- Outstanding performance at high frequency operation
- Stable temperature behavior
- Direct mounting to heatsink (isolated package)
- Low junction-to-case thermal resistance
- RoHS compliant

## Application

---

The MSCSM70HM038AG device is designed for the following applications:

- Welding converters
- Switched mode power supplies
- Uninterruptible power supplies
- EV motor and traction drive

## 1. Electrical Specifications

This section provides the electrical specifications of the MSCSM70HM038AG device.

### 1.1 SiC MOSFET Characteristics (Per SiC MOSFET)

The following table lists the absolute maximum ratings per SiC MOSFET of the MSCSM70HM038AG device.

**Table 1-1. Absolute Maximum Ratings**

Symbol	Parameter	Maximum Ratings	Unit
$V_{DSS}$	Drain-Source voltage	700	V
$I_D$	Continuous drain current	$T_C = 25\text{ }^\circ\text{C}$	464
		$T_C = 80\text{ }^\circ\text{C}$	369
$I_{DM}$	Pulsed drain current	900	
$V_{GS}$	Gate-Source voltage	-10/23	V
$R_{DS(on)}$	Drain-Source ON resistance	4.8	m $\Omega$
$P_D$	Power dissipation	$T_C = 25\text{ }^\circ\text{C}$	1277

The following table lists the electrical characteristics per SiC MOSFET of the MSCSM70HM038AG device.

**Table 1-2. Electrical Characteristics**

Symbol	Characteristic	Test Conditions	Min.	Typ.	Max.	Unit	
$I_{DSS}$	Zero gate voltage drain current	$V_{GS} = 0V$ $V_{DS} = 700V$	—	—	400	$\mu\text{A}$	
$R_{DS(on)}$	Drain-Source on resistance	$V_{GS} = 20V$ $I_D = 160A$	$T_J = 25\text{ }^\circ\text{C}$	—	3.8	4.8	m $\Omega$
			$T_J = 175\text{ }^\circ\text{C}$	—	4.8	—	
$V_{GS(th)}$	Gate threshold voltage	$V_{GS} = V_{DS}$ $I_D = 16\text{ mA}$	1.9	2.4	—	V	
$I_{GSS}$	Gate-Source leakage current	$V_{GS} = 20V; V_{DS} = 0V$	—	—	400	nA	

# MSCSM70HM038AG

## Electrical Specifications

The following table lists the dynamic characteristics per SiC MOSFET of the MSCSM70HM038AG device.

**Table 1-3. Dynamic Characteristics**

Symbol	Characteristic	Test Conditions	Min.	Typ.	Max.	Unit	
$C_{iss}$	Input capacitance	$V_{GS} = 0V$	—	18	—	nF	
$C_{oss}$	Output capacitance	$V_{DS} = 700V$	—	2	—		
$C_{rss}$	Reverse transfer capacitance	$f = 1\text{ MHz}$	—	0.11	—		
$Q_g$	Total gate charge	$V_{GS} = -5V/20V$	—	860	—	nC	
$Q_{gs}$	Gate-Source charge	$V_{Bus} = 470V$	—	232	—		
$Q_{gd}$	Gate-Drain charge	$I_D = 160A$	—	140	—		
$T_{d(on)}$	Turn-on delay time	$V_{GS} = -5V/20V$	$T_J = 150\text{ }^\circ\text{C}$	—	78	—	ns
$T_r$	Rise time	$V_{Bus} = 400V$		—	125	—	
$T_{d(off)}$	Turn-off delay time	$I_D = 320A$		—	214	—	
$T_f$	Fall time	$R_{G(on)} = 18\Omega$ $R_{G(off)} = 4\Omega$		—	92	—	
$E_{on}$	Turn-on energy	$V_{GS} = -5V/20V$	$T_J = 150\text{ }^\circ\text{C}$	—	6.7	—	mJ
$E_{off}$	Turn-off energy	$V_{Bus} = 400V$ $I_D = 320A$ $R_{G(on)} = 18\Omega$ $R_{G(off)} = 4\Omega$		—	7	—	
$R_{Gint}$	Internal gate resistance		—	1.4	—	$\Omega$	
$R_{thJC}$	Junction-to-case thermal resistance		—	—	0.117	$^\circ\text{C/W}$	

The following table lists the body diode ratings and characteristics per SiC MOSFET of the MSCSM70HM038AG device.

**Table 1-4. Body Diode Ratings and Characteristics**

Symbol	Characteristic	Test Conditions	Min.	Typ.	Max.	Unit
$V_{SD}$	Diode forward voltage	$V_{GS} = 0V; I_{SD} = 160A$	—	3.4	—	V
		$V_{GS} = -5V; I_{SD} = 160A$	—	3.8	—	
$t_{rr}$	Reverse recovery time	$I_{SD} = 160A; V_{GS} = -5V$	—	40	—	ns
$Q_{rr}$	Reverse recovery charge	$V_R = 400V; di_F/dt = 4000\text{ A}/\mu\text{s}$	—	2	—	$\mu\text{C}$
$I_{rr}$	Reverse recovery current		—	76	—	A

### 1.2 Thermal and Package Characteristics

The following table lists the thermal and package characteristics of the MSCSM70HM038AG device.

**Table 1-5. Thermal and Package Characteristics**

Symbol	Characteristics	Min.	Max.	Unit	
V <sub>ISOL</sub>	RMS isolation voltage, any terminal to case t = 1 min, 50 Hz/60 Hz	4000	—	V	
T <sub>J</sub>	Operating junction temperature range	-40	175	°C	
T <sub>JOP</sub>	Recommended junction temperature under switching conditions	-40	T <sub>Jmax</sub> -25		
T <sub>STG</sub>	Storage temperature range	-40	125		
T <sub>C</sub>	Operating case temperature	-40	125		
Torque	Mounting torque				
	To heatsink	M6	3	5	N.m
	For terminals	M5	2	3.5	
Wt	Package weight	—	300	g	

### 1.3 Typical SiC MOSFET Performance Curve

This section shows the typical SiC MOSFET performance curves of the MSCSM70HM038AG device.

**Figure 1-1. Maximum Thermal Impedance**

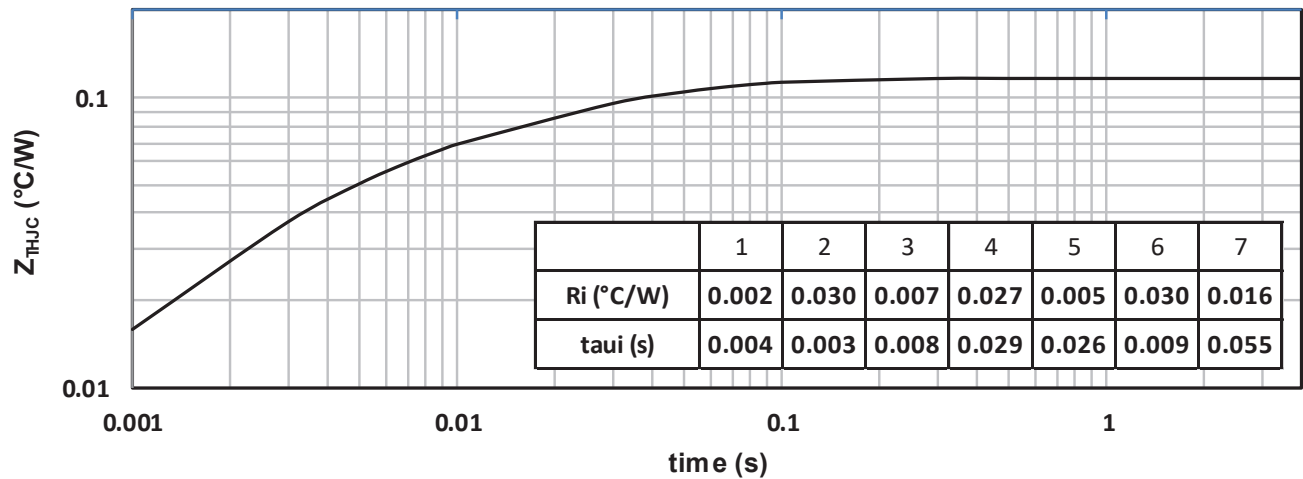

Figure 1-2. Output Characteristics,  $T_J = 25^\circ\text{C}$

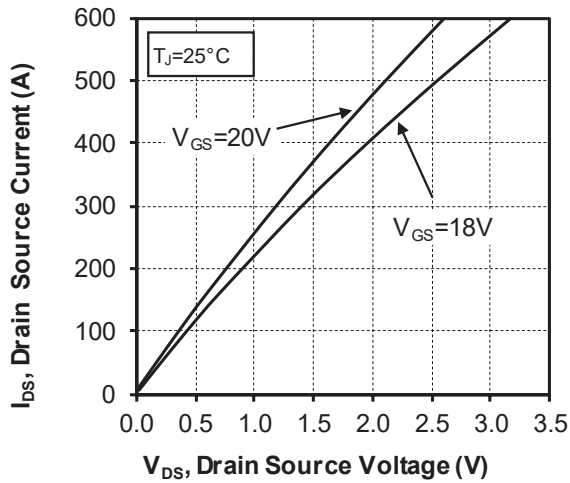

Figure 1-3. Output Characteristics,  $T_J = 175^\circ\text{C}$

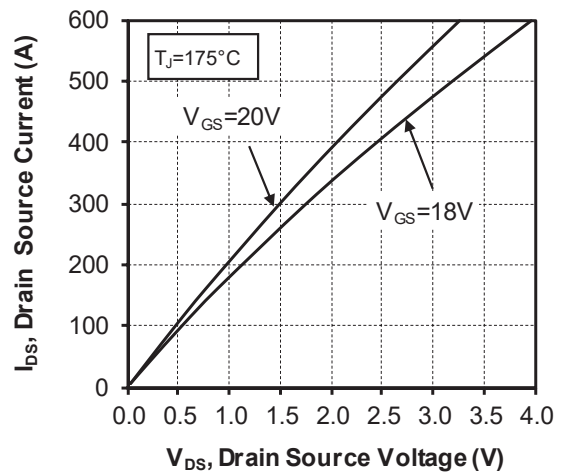

Figure 1-4. Normalized  $R_{DS(on)}$  vs. Temperature

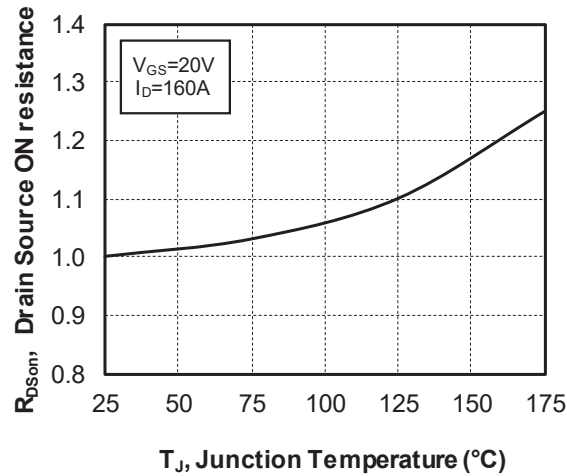

Figure 1-5. Transfer Characteristics

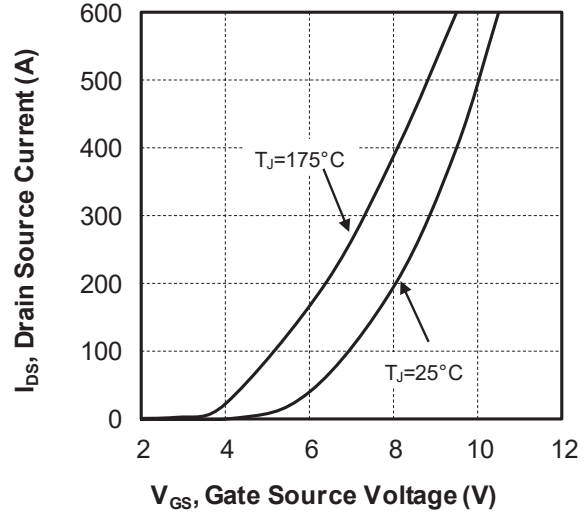

Figure 1-6. Switching Energy vs. Current

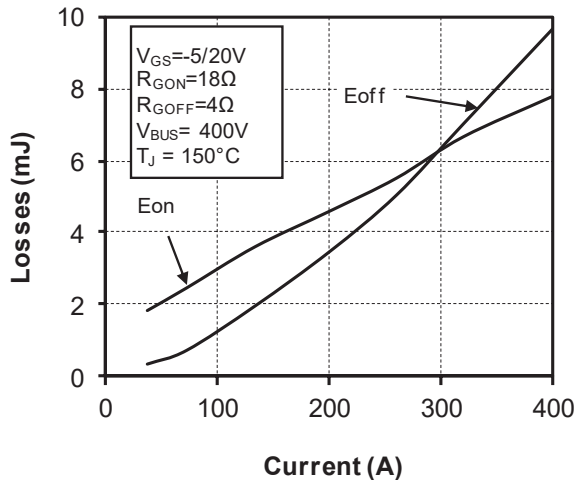
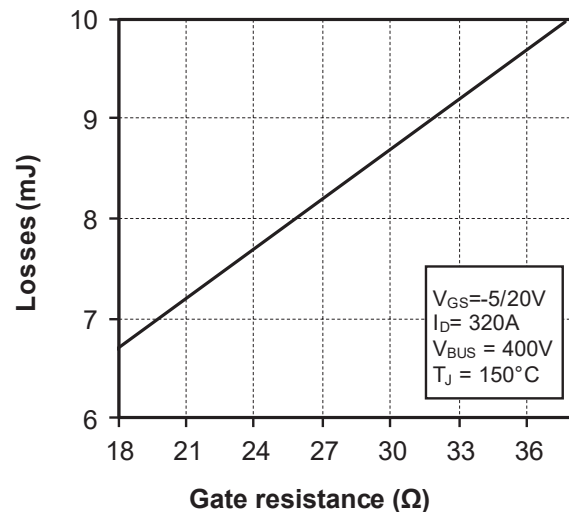

Figure 1-7. Turn On Energy vs. Rg



# MSCSM70HM038AG

## Electrical Specifications

Figure 1-8. Capacitance vs. Drain Source Voltage

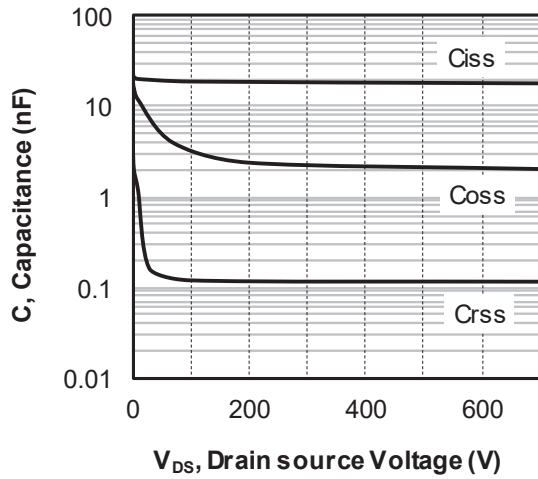

Figure 1-9. Gate Charge vs. Gate Source Voltage

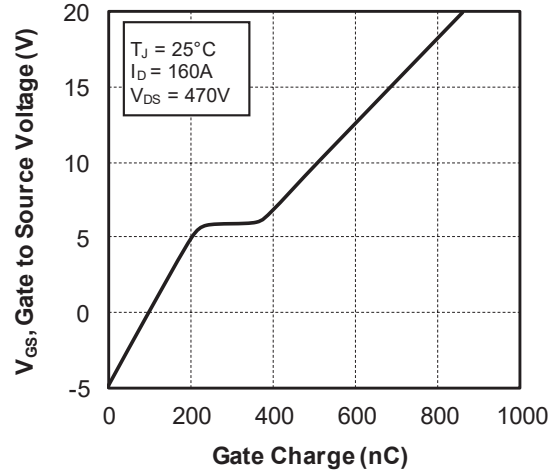

Figure 1-10. Body Diode Characteristics, T<sub>J</sub> = 25 °C

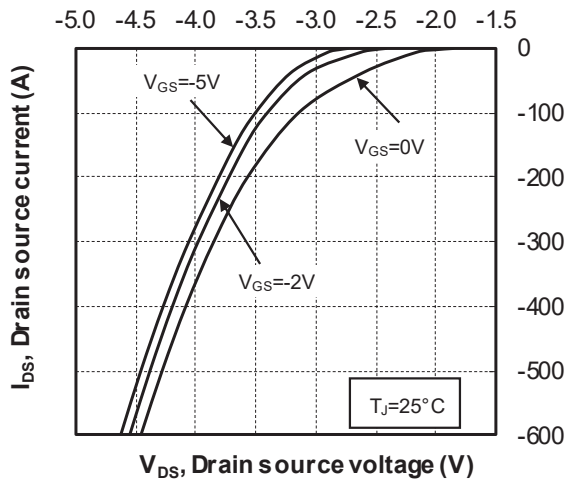

Figure 1-11. 3<sup>rd</sup> Quadrant Characteristics, T<sub>J</sub> = 25 °C

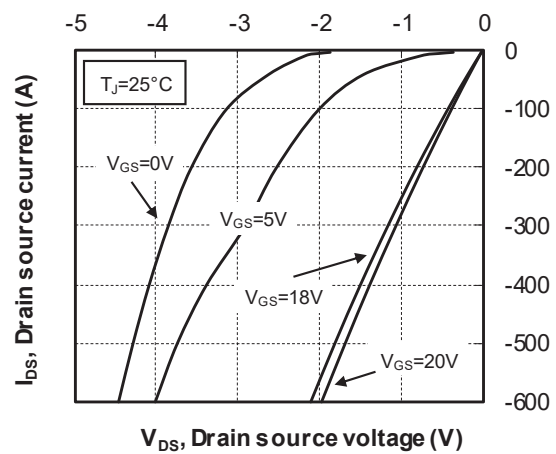

Figure 1-12. Body Diode Characteristics, T<sub>J</sub> = 175 °C

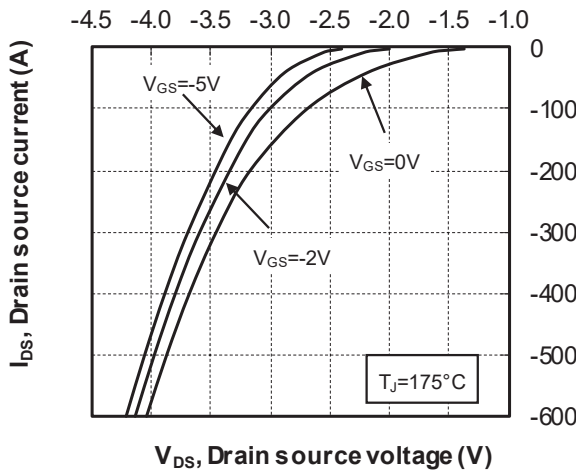

Figure 1-13. 3<sup>rd</sup> Quadrant Characteristics, T<sub>J</sub> = 175 °C

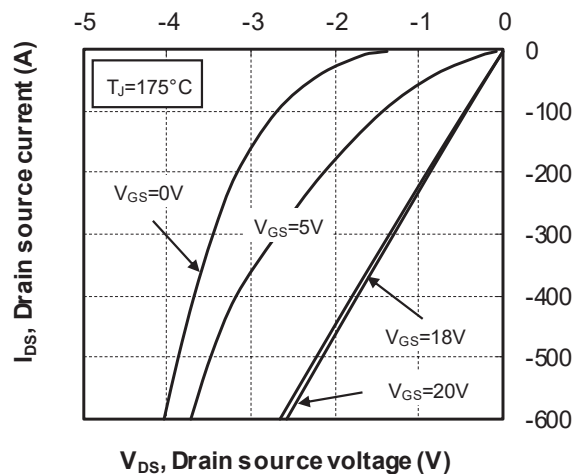
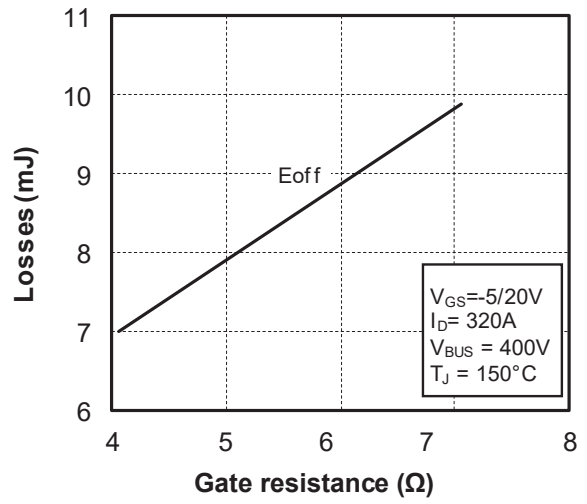
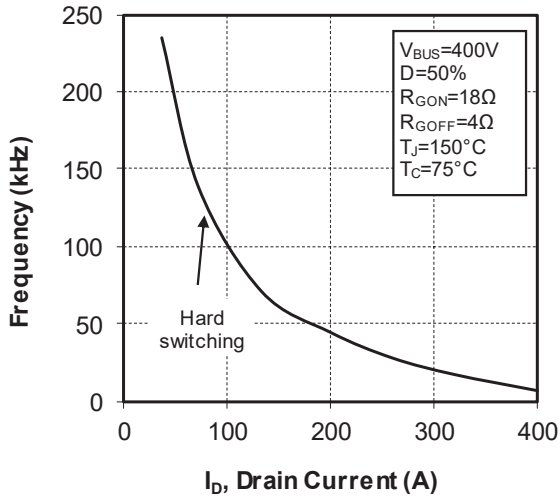

Figure 1-14. Operating Frequency vs. Drain Current      Figure 1-15. Turn Off Energy vs. Rg





## 2. Package Specifications

The following section shows the package specification of the MSCSM70HM038AG device.

### 2.1 Package Outline

The following figure shows the package outline drawing of the MSCSM70HM038AG device. The dimensions in the following figure are in millimeters.

Figure 2-1. Package Outline Drawing

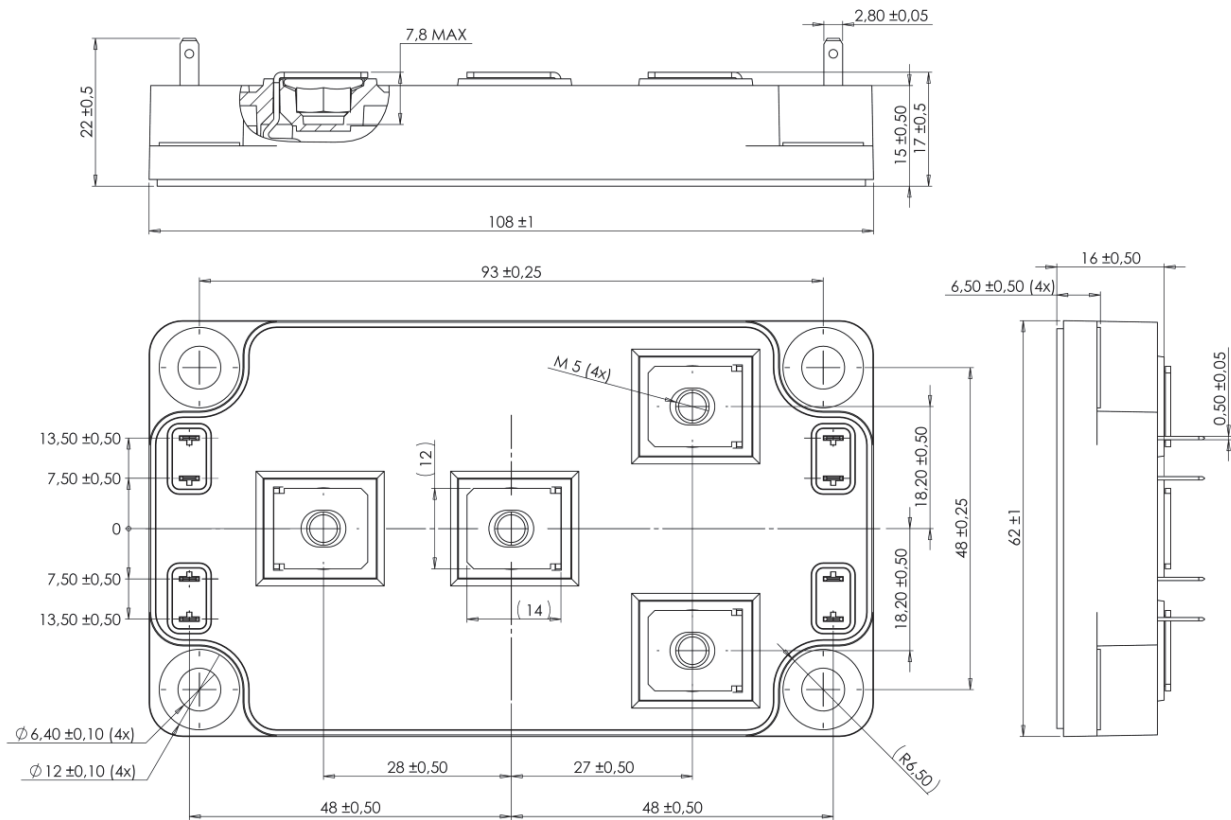

**Note:** See [APT0601—Mounting Instructions for SP6 Power Modules](#) for more information.

**3. Revision History**

Revision	Date	Description
A	06/2022	Initial Revision

---

## Microchip Information

---

### The Microchip Website

---

Microchip provides online support via our website at [www.microchip.com/](http://www.microchip.com/). This website is used to make files and information easily available to customers. Some of the content available includes:

- **Product Support** – Data sheets and errata, application notes and sample programs, design resources, user's guides and hardware support documents, latest software releases and archived software
- **General Technical Support** – Frequently Asked Questions (FAQs), technical support requests, online discussion groups, Microchip design partner program member listing
- **Business of Microchip** – Product selector and ordering guides, latest Microchip press releases, listing of seminars and events, listings of Microchip sales offices, distributors and factory representatives

### Product Change Notification Service

---

Microchip's product change notification service helps keep customers current on Microchip products. Subscribers will receive email notification whenever there are changes, updates, revisions or errata related to a specified product family or development tool of interest.

To register, go to [www.microchip.com/pcn](http://www.microchip.com/pcn) and follow the registration instructions.

### Customer Support

---

Users of Microchip products can receive assistance through several channels:

- Distributor or Representative
- Local Sales Office
- Embedded Solutions Engineer (ESE)
- Technical Support

Customers should contact their distributor, representative or ESE for support. Local sales offices are also available to help customers. A listing of sales offices and locations is included in this document.

Technical support is available through the website at: [www.microchip.com/support](http://www.microchip.com/support)

### Microchip Devices Code Protection Feature

---

Note the following details of the code protection feature on Microchip products:

- Microchip products meet the specifications contained in their particular Microchip Data Sheet.
- Microchip believes that its family of products is secure when used in the intended manner, within operating specifications, and under normal conditions.
- Microchip values and aggressively protects its intellectual property rights. Attempts to breach the code protection features of Microchip product is strictly prohibited and may violate the Digital Millennium Copyright Act.
- Neither Microchip nor any other semiconductor manufacturer can guarantee the security of its code. Code protection does not mean that we are guaranteeing the product is "unbreakable". Code protection is constantly evolving. Microchip is committed to continuously improving the code protection features of our products.

### Legal Notice

---

This publication and the information herein may be used only with Microchip products, including to design, test, and integrate Microchip products with your application. Use of this information in any other manner violates these terms. Information regarding device applications is provided only for your convenience and may be superseded

by updates. It is your responsibility to ensure that your application meets with your specifications. Contact your local Microchip sales office for additional support or, obtain additional support at [www.microchip.com/en-us/support/design-help/client-support-services](http://www.microchip.com/en-us/support/design-help/client-support-services).

THIS INFORMATION IS PROVIDED BY MICROCHIP "AS IS". MICROCHIP MAKES NO REPRESENTATIONS OR WARRANTIES OF ANY KIND WHETHER EXPRESS OR IMPLIED, WRITTEN OR ORAL, STATUTORY OR OTHERWISE, RELATED TO THE INFORMATION INCLUDING BUT NOT LIMITED TO ANY IMPLIED WARRANTIES OF NON-INFRINGEMENT, MERCHANTABILITY, AND FITNESS FOR A PARTICULAR PURPOSE, OR WARRANTIES RELATED TO ITS CONDITION, QUALITY, OR PERFORMANCE.

IN NO EVENT WILL MICROCHIP BE LIABLE FOR ANY INDIRECT, SPECIAL, PUNITIVE, INCIDENTAL, OR CONSEQUENTIAL LOSS, DAMAGE, COST, OR EXPENSE OF ANY KIND WHATSOEVER RELATED TO THE INFORMATION OR ITS USE, HOWEVER CAUSED, EVEN IF MICROCHIP HAS BEEN ADVISED OF THE POSSIBILITY OR THE DAMAGES ARE FORESEEABLE. TO THE FULLEST EXTENT ALLOWED BY LAW, MICROCHIP'S TOTAL LIABILITY ON ALL CLAIMS IN ANY WAY RELATED TO THE INFORMATION OR ITS USE WILL NOT EXCEED THE AMOUNT OF FEES, IF ANY, THAT YOU HAVE PAID DIRECTLY TO MICROCHIP FOR THE INFORMATION.

Use of Microchip devices in life support and/or safety applications is entirely at the buyer's risk, and the buyer agrees to defend, indemnify and hold harmless Microchip from any and all damages, claims, suits, or expenses resulting from such use. No licenses are conveyed, implicitly or otherwise, under any Microchip intellectual property rights unless otherwise stated.

## Trademarks

---

The Microchip name and logo, the Microchip logo, Adaptec, AVR, AVR logo, AVR Freaks, BesTime, BitCloud, CryptoMemory, CryptoRF, dsPIC, flexPWR, HELDO, IGLOO, JukeBlox, KeeLoq, Kleer, LANCheck, LinkMD, maXStylus, maXTouch, MediaLB, megaAVR, Microsemi, Microsemi logo, MOST, MOST logo, MPLAB, OptoLyzer, PIC, picoPower, PICSTART, PIC32 logo, PolarFire, Prochip Designer, QTouch, SAM-BA, SenGenuity, SpyNIC, SST, SST Logo, SuperFlash, Symmetricom, SyncServer, Tachyon, TimeSource, tinyAVR, UNI/O, Vectron, and XMEGA are registered trademarks of Microchip Technology Incorporated in the U.S.A. and other countries.

AgileSwitch, APT, ClockWorks, The Embedded Control Solutions Company, EtherSynch, Flashtec, Hyper Speed Control, HyperLight Load, Libero, motorBench, mTouch, Powermite 3, Precision Edge, ProASIC, ProASIC Plus, ProASIC Plus logo, Quiet- Wire, SmartFusion, SyncWorld, Temux, TimeCesium, TimeHub, TimePictra, TimeProvider, TrueTime, and ZL are registered trademarks of Microchip Technology Incorporated in the U.S.A.

Adjacent Key Suppression, AKS, Analog-for-the-Digital Age, Any Capacitor, AnyIn, AnyOut, Augmented Switching, BlueSky, BodyCom, Clockstudio, CodeGuard, CryptoAuthentication, CryptoAutomotive, CryptoCompanion, CryptoController, dsPICDEM, dsPICDEM.net, Dynamic Average Matching, DAM, ECAN, Espresso T1S, EtherGREEN, GridTime, IdealBridge, In-Circuit Serial Programming, ICSP, INICnet, Intelligent Paralleling, IntellIMOS, Inter-Chip Connectivity, JitterBlocker, Knob-on-Display, KoD, maxCrypto, maxView, memBrain, Mindi, MiWi, MPASM, MPF, MPLAB Certified logo, MPLIB, MPLINK, MultiTRAK, NetDetach, Omniscient Code Generation, PICDEM, PICDEM.net, PICkit, PICtail, PowerSmart, PureSilicon, QMatrix, REAL ICE, Ripple Blocker, RTAX, RTG4, SAM-ICE, Serial Quad I/O, simpleMAP, SimpliPHY, SmartBuffer, SmartHLS, SMART-I.S., storClad, SQL, SuperSwitcher, SuperSwitcher II, Switchtec, SynchroPHY, Total Endurance, Trusted Time, TSHARC, USBCheck, VariSense, VectorBlox, VeriPHY, ViewSpan, WiperLock, XpressConnect, and ZENA are trademarks of Microchip Technology Incorporated in the U.S.A. and other countries.

SQTP is a service mark of Microchip Technology Incorporated in the U.S.A.

The Adaptec logo, Frequency on Demand, Silicon Storage Technology, and Symmcom are registered trademarks of Microchip Technology Inc. in other countries.

GestIC is a registered trademark of Microchip Technology Germany II GmbH & Co. KG, a subsidiary of Microchip Technology Inc., in other countries.

All other trademarks mentioned herein are property of their respective companies.

© 2022, Microchip Technology Incorporated and its subsidiaries. All Rights Reserved.

ISBN: 978-1-6683-0620-8

## **Quality Management System**

---

For information regarding Microchip's Quality Management Systems, please visit [www.microchip.com/quality](http://www.microchip.com/quality).