



Mallory Sonalert Products, Inc.

Part #: **MSE28MPS1**

Sales Outline Drawing

Revision: **C**

Specifications:

Sound Level Category	Medium
Mode of Operation	Short Beep @ 1 PPS, 10% Duty Cycle
Voltage Rating	20 to 28 VDC
Frequency	3900 ± 500 Hz
Loudness @ 1 FT	75 to 85 dB(A) Typ.
Current Draw	50mA MAX
Housing Material	Valox (UL94V-0), Color: Black
Storage Temperature	-40° to +80° C
Operating Temperature	-40° to +65° C
Weight (Typical)	4.0g
Options	Please contact factory.

Dimensions: Inches (mm)

ROHS Compliant

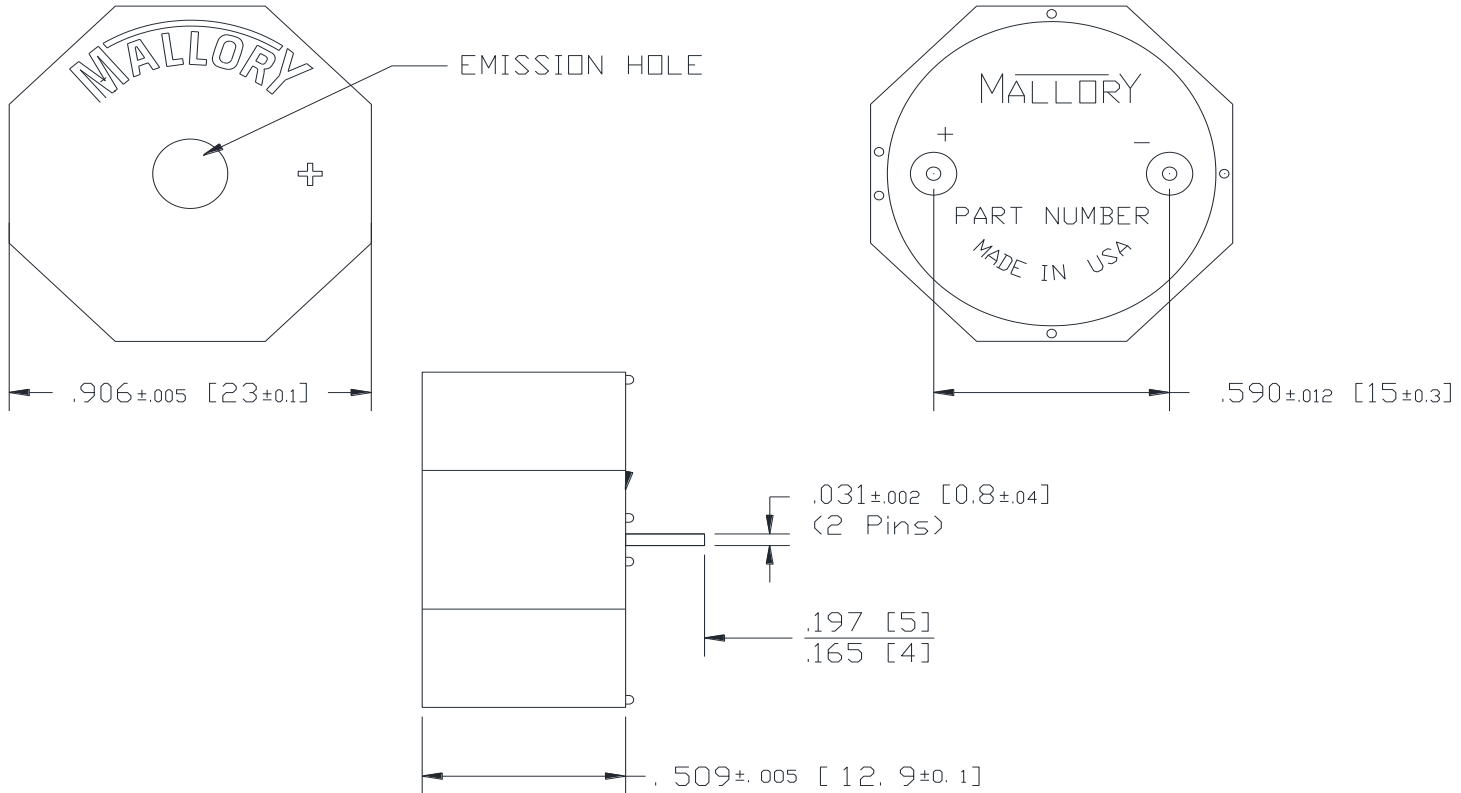

NOTE A:
TERMINALS - .031" DIA. NICKEL/TIN COATED BRASS.

NOTE B:
MOUNTING- INSERT INTO PRINTED CIRCUIT BOARD AND HAND OR MACHINE SOLDER.
UNITS ARE SUITABLE FOR WAVE SOLDERING. RECOMMENDED MAXIMUM TEMPERATURE
AND TIME DURATION FOR WAVE SOLDERING IS +270°C AND 3 SECONDS RESPECTIVELY.