

MT2A

Cable Actuated Sensor

Test Applications • Voltage Divider

Compact String Pot • Flight/Crash Test Applications
Dual Axis 360° Mounting Bracket
3, 9, 15, 30 and 50-inch Stroke Range Options
Aluminum & Polycarbonate Enclosure • GAM Certification

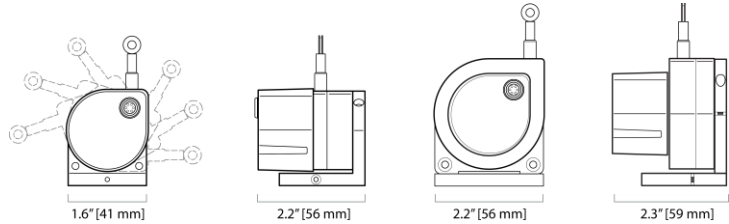

The MT2A is a member of our family of rugged, accurate miniature cable-extension position transducers designed specifically for test applications. One of the major benefits to this sensor is its 2-axis 360° rotating mounting bracket to allow for fast and simple installation in any direction.

The MT2A comes in 5 different measuring ranges: 0-3", 0-9", 0-15", 0-30", 0-50" and features a highly-tensioned heavy-duty measuring cable designed for the high-acceleration demands encountered in flight testing and automotive crash tests.

For extreme impact applications, a new rugged all aluminum sensor cover is now available!

Output Signal

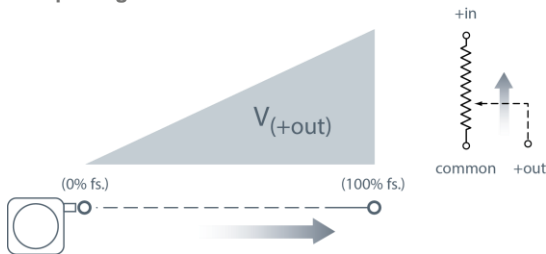

General

Full Stroke Range Options	0-3, 0-9, 0-15, 0-30, 0-50 inches, min.
Output Signal	voltage divider (potentiometer)
Accuracy	± 1.1% to 0.15% full stroke (see ordering information)
Repeatability	± 0.02% full stroke
Resolution	essentially infinite
Measuring Cable	Ø.019-in. nylon-coated stainless steel
Enclosure Material	anodized aluminum
Sensor Cover Options	aluminum or polycarbonate
Sensor	conductive plastic-hybrid potentiometer
Weight	0.5 lb. max.

Electrical

Input Resistance	10K ohms (± 10%)
Power Rating, Watts	2.0 at 158°F (70° C), derated to 0 @ 255°F (125°C)
Recommended Maximum Input Voltage	30V (AC or DC)
Electrical Stroke	94% ±4% of input voltage
Mating Plug	LEMO FGG.OB.304.CLAD52

Mechanical

Measuring Cable Tension Options	see ordering information
Maximum Measuring Cable Acceleration	136 g

Environmental

Operating Temperature	-65° to 255° F (-55° to 125°C)
------------------------------	---------------------------------

Outline Drawing (0-3 to 0-30 inch ranges)

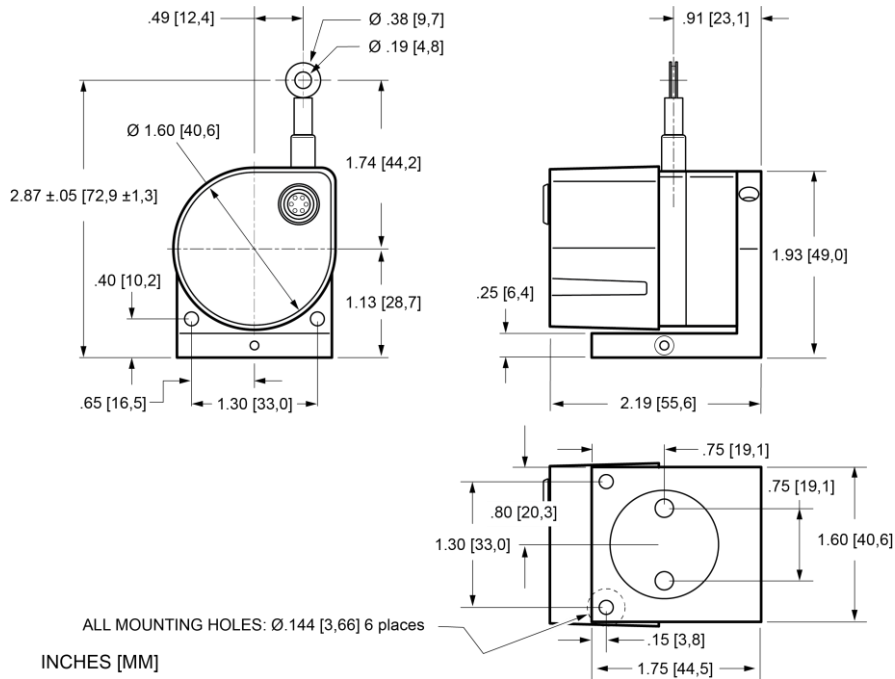

Outline Drawing (0-50 inch range)

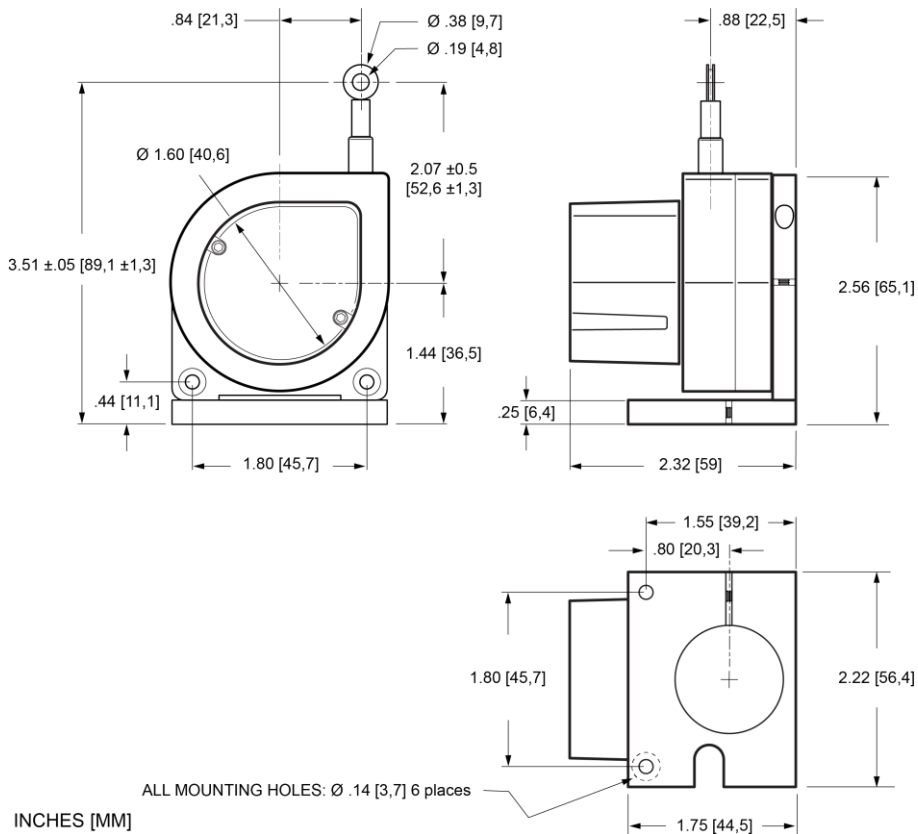

Ordering Information

Model Number:

MT2A - - - **10K** -
order code: **R** **A** **B** **C**

Sample Model Number:

MT2A - 9E - 33 - 10K - M1A

- R** range: 9 inches
- A** measuring cable termination: eyelet
- B** measuring cable tension: 33 oz. (±6 oz.)
- C** electrical connection: end-mounted connector w/ aluminum sensor cover

Full Stroke Range:

R <i>order code:</i>	3	9	15	30	50
full stroke range, min:	3 inches	9 inches	15 inches	30 inches	50 inches
potentiometer cycle-life:	2.5×10^6	8.3×10^5	5.0×10^5	2.5×10^5	2.5×10^5
accuracy (% of full stroke):	1.1 %	.25%	.20%	.15%	.15%

Measuring Cable Termination:

A *order code:* **E** **L**

Eyelet Leader Cable (24 in. long)

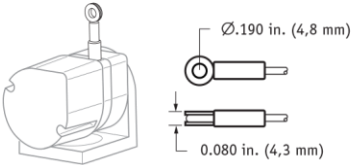

Ø.190 in. (4,8 mm)

0.080 in. (4,3 mm)

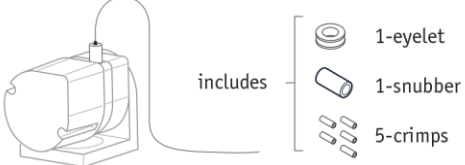





includes



- 1-eyelet
- 1-snubber
- 5-crimps

Measuring Cable Tension:

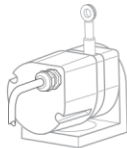
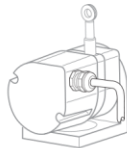
B <i>order code:</i>	9	14	33
3, 9, 15, 30-in. range options:	9 (±2) oz.	14 (±4) oz.	33 (±6) oz.
max. cable acceleration:	99 g	136 g	136 g
B <i>order code:</i>	9	22	
50-in. range options:	9 (±2) oz.	22 (±6) oz.	
max. cable acceleration:	46 g	68 g	

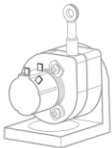
Electrical Connection/ Sensor Cover:

ⓐ	order code:	M1	M1A	M2	M2A	M3	M3A		
	sensor cover:	polycarbonate	aluminum	polycarbonate	aluminum	polycarbonate	aluminum		
	electrical connection:		end-mount connector*		side-mount connector*		top-mount connector*		
ⓑ	order code:	C1	C1A	C2	C2A	C3	C3A	S	
	sensor cover:	polycarbonate	aluminum	polycarbonate	aluminum	polycarbonate	aluminum	none**	
	electrical connection:		end-mount, instrumentation cable (15-ft. long, 24 ga., shielded)		side-mount, instrumentation cable (15-ft. long, 24 ga., shielded)		top-mount, instrumentation cable (15-ft. long, 24 ga., shielded)		solder terminals

	4-pin mating plug	pin#	signal		Instrumentation Cable	color	signal		Solder Terminals
contact view	Lemo FGG.OB.304.CLAD52	1	+in	24 ga., shielded	Red	+in		CW	+in
		2	common		Black	common		CCW	common
		3	+out		Green	+out		S	+out

*mating plug included **blank cover available, see **Accessories** on next page

Accessories



Part Number	Description
9603957-0015	15 ft. long cordset. Includes mating connector with 15 ft., 24 gauge, shielded multiconductor cable

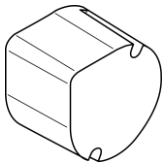

Additional blank sensor covers can be ordered separately. This cover comes without electrical wiring access holes so customer can drill to their requirements. Includes screws and gasket.

Part Number	Description
9604197-0000	Aluminum sensor cover
9603958-0000	Polycarbonate sensor cover