

Sensitivity Wavelength Range: 800nm~2600nm

The MTPD260T8-300 from Marktech, a high sensitivity and high reliability product series, is ideally suited for Optical Communication devices. Custom packaging options for this die is also available.

FEATURES

- > High Speed Response
- > TO-39 Hermetically Sealed Package
- > Active Area of 3.0mm Φ / High Sensitivity
- > Spectral Range 800nm - 2600nm

APPLICATIONS

- > High Speed Optical Communications
- > Industrial Controls
- > Gas/Water Analysis
- > LIDAR
- > Medical

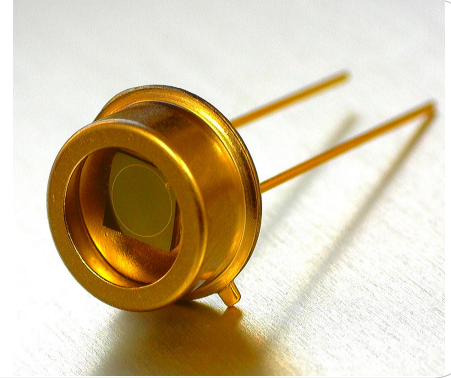

Absolute Maximum Ratings (Ta=25°C)



ITEMS	SYMBOL	RATINGS	UNIT
Active Area	Φ	3.0	mm
Operating Temperature Range	Topr	-40 to +85	°C
Storage Temperature Range	Tstg	-40 to +125	°C

Electrical & Optical Characteristics (Ta = 25°C)

ITEMS	SYMBOL	CONDITIONS	MIN	TYP	MAX	UNIT
Breakdown Voltage	VR	IR=100uA	--	--	1	V
Sensitivity Range	λ	VR=0V	800	--	2600	nm
Dark Current	ID	VR=0V	--	80	--	nA
Dark Current	ID	VR=1V	--	770	--	uA
Capacitance	C	VR=0V	--	3100	--	pF
Capacitance	C	VR=1V	--	500	--	pF
Responsivity	R	λ =2400nm	--	1.24	--	A/W
Shunt Resistance	RS	VR=10mV	--	0.5	--	kOhm
Quantum Efficiency	QE	λ =1840nm	--	72	--	%

Package Dimensions

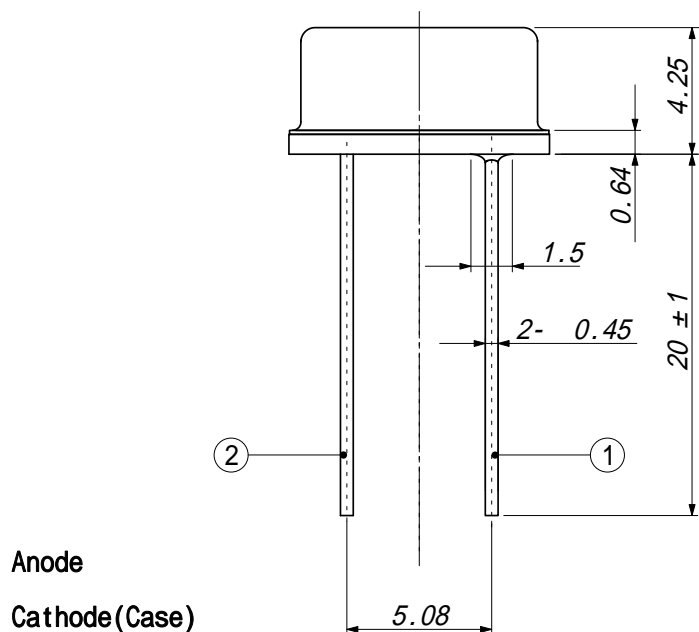
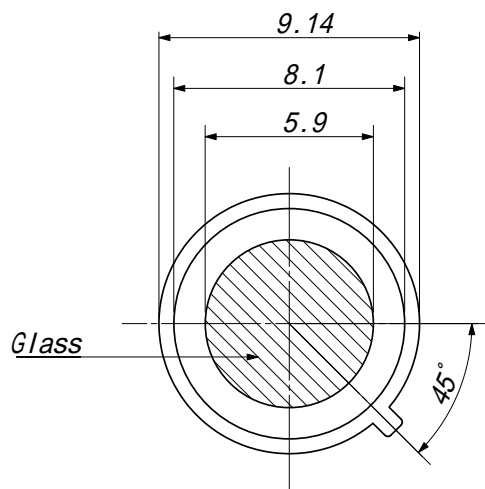

TOLERANCE ; ± 0.15

Unit: mm, Tolerance: ±0.2

The information contained herein is subject to change without notice.

2022-12-8

Spectral Responsivity

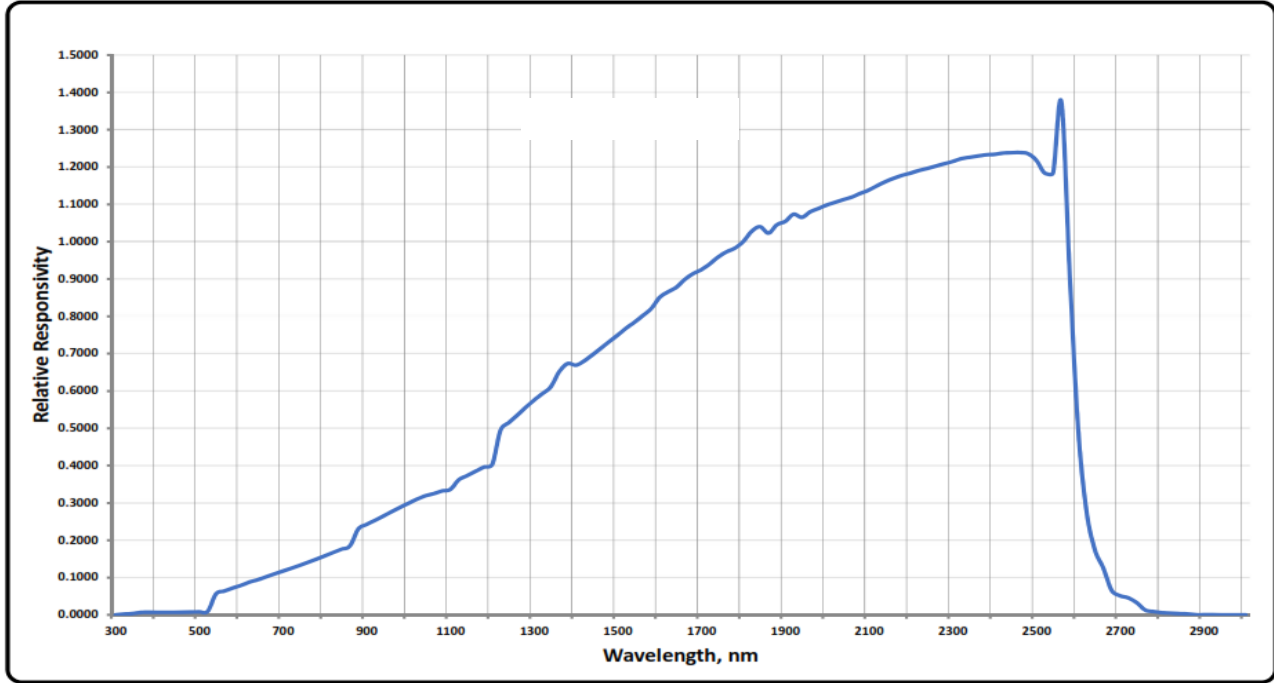

Quantum Efficiency

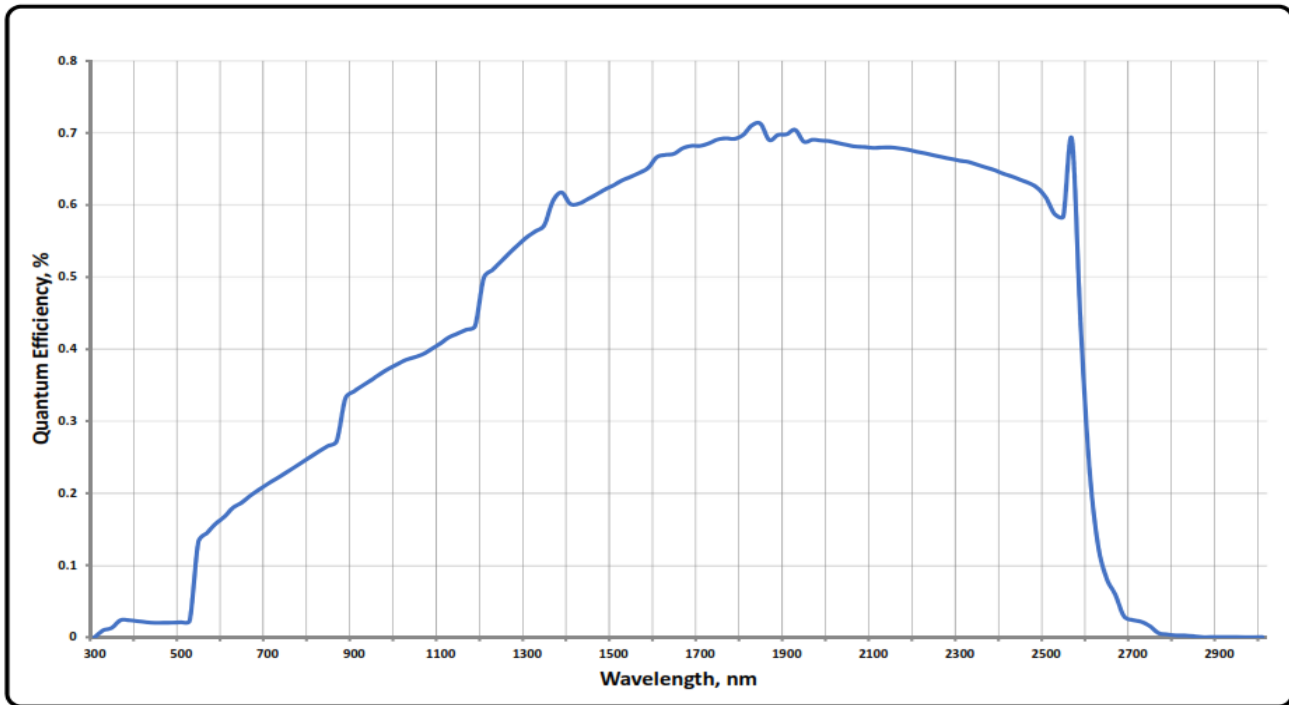

The information contained herein is subject to change without notice.

2022-12-8