

Document MT1603P, Revision 2020.B, Jun 2020

MTi 600-series Datasheet

IMU, VRU, AHRS and GNSS/INS

Xsens

Revision	Date	By	Changes
A	Sept. 2019	AKO, MCR	Initial release
B	Sep 2019	AKO	Grammar and wording update
C	Nov 2019	WBO, MCR	Maximum output current for the SYNC output
D	Nov 2019	AKO	Xsens brand update
2020.A	Jun 2020	AKO	Added MTi-680G
2020.B	Sept 2020	AKO	Added reach declaration Updated acc specifications Added lever arm figure

© 2005-2020, Xsens Technologies B.V. All rights reserved. Information in this document is subject to change without notice. Xsens, Xsens DOT, MVN, MotionGrid, MTi, MTi-G, MTx, MTw, Awinda and KiC are registered trademarks or trademarks of Xsens Technologies B.V. and/or its parent, subsidiaries and/or affiliates in The Netherlands, the USA and/or other countries. All other trademarks are the property of their respective owners.

Table of Contents

1	General information	7
1.1	Ordering information	8
1.2	MTi 600-series architecture	9
1.3	MTi 600-series product variants	10
1.3.1	MTi-610 IMU	10
1.3.2	MTi-620 VRU	10
1.3.3	MTi-630 AHRS	11
1.3.4	MTi-670 GNSS/INS	11
1.3.5	MTi-680G RTK GNSS/INS	11
2	Sensor specifications	12
2.1	MTi 600-series performance specifications	12
2.2	Sensor specifications	13
3	Functional description	15
3.1	Pin description module	15
3.2	Pin description MTi-680G	16
3.3	Peripheral interfaces	17
3.3.1	CAN (Controller Area Network)	17
3.3.2	RS232 with RTS/CTS flow control	17
3.3.3	UART	17
3.3.4	RTCM input port	17
4	Signal processing and algorithms	18
4.1	Signal processing pipeline	18
4.1.1	Strapdown integration	18
4.1.2	Xsens sensor fusion algorithm for VRU and AHRS product types	18
4.1.3	Xsens sensor fusion algorithm for the GNSS/INS product type	22
4.2	Data output	24
4.2.1	Xbus output	25
4.2.2	NMEA output	25
4.2.3	CAN output	25
4.3	GNSS input	25
4.4	Magnetic interference	26
4.4.1	Magnetic Field Mapping (MFM)	26
4.5	Frames of reference	27
5	Synchronization options	29
5.1	Trigger signal	29

5.2	SyncIn	30
5.2.1	TriggerIndication function	30
5.2.2	SendLatest function	30
5.2.3	StartSampling function	30
5.2.4	Clock Bias Estimation function	30
5.2.5	1PPS Time-pulse function	31
5.3	SyncOut.....	32
5.3.1	Interval Transition Measurement function	32
5.4	Combining multiple Sync functions	32
6	System and electrical specifications.....	33
6.1	Interface specifications	33
6.2	System specifications.....	33
6.3	Electrical specifications.....	35
6.4	Absolute maximum ratings	36
7	Design and packaging	37
7.1	Design	37
7.2	Packaging information.....	38
7.2.1	MTi 600-series module	38
7.2.2	MTi-680G.....	39
8	Declaration of conformity.....	40
8.1	EU Declaration of Conformity MTi-600 module	40
8.2	EU Declaration of Conformity MTi-600 rugged	41
8.3	FCC Declaration of Conformity MTi-600 module.....	42
8.4	FCC Declaration of Conformity MTi-600 rugged	43
8.5	Reach Declaration	44

List of Tables

Table 1:	MTi product documentation overview.....	7
Table 2:	Ordering information for MTi 600-series products.....	8
Table 3:	Orientation performance specifications	12
Table 4:	Position and velocity performance specifications for MTi-670-DK.....	12
Table 5:	Position and velocity performance specifications for MTi-680G with RTK correction signals provided	12
Table 6:	MTi 600-series gyroscope specifications	13
Table 7:	MTi 600-series accelerometer specifications	13
Table 8:	MTi 600-series magnetometer specifications.....	13

Table 9: MTi 600-series barometer specifications.....	13
Table 10: MTi 600-series orthogonality specifications	13
Table 11: MTi-680G GNSS specifications	14
Table 12: Pin descriptions of the MTi-600	15
Table 13: Pin descriptions MTi-680G Host Interface	16
Table 14: Pin descriptions MTi-680G RTCM corrections.....	16
Table 15 RTCM input port baud rates	17
Table 16: Filter profiles for MTi-620 and MTi-630.....	19
Table 17: Heading Behaviour	20
Table 18: Filter profiles for MTi-670 and MTi-680G (GNSS/INS).....	24
Table 19: Output data rates.....	25
Table 20: Settings required to enable NMEAin for the MTi-670	26
Table 21: Generic synchronization parameters	29
Table 22: Remarks on combining multiple Sync functions	32
Table 23: Communication interfaces	33
Table 24: System specifications of MTi 600-series modules.....	33
Table 25: System specifications of MTi-680G	33
Table 26: Supply voltage specifications	35
Table 27: I/O electrical specifications	35
Table 28: Absolute maximum ratings MTi 600-series module	36

List of Figures

Figure 1: MTi 600-series module diagram	9
Figure 2: Pin configuration of the MTi 600-series module (bottom view)	15
Figure 3 Connectors and pin numbers on the MTi-680G housing	16
Figure 4: Filter profile and heading behaviour selection: a tiered approach	21
Figure 5: Example of lever arm measurements	23
Figure 6: Lever arm correction for MTi-680G.....	23
Figure 7 Default sensor fixed coordinate system (S_{xyz}) for the MTi 600-series module ...	27
Figure 8: Default sensor coordinate system for the MTi-680G.....	28
Figure 9: Location origin of measurements MTi-600 module (dimensions in mm).....	37
Figure 10: Location origin of measurements MTi-680G (dimensions in mm)	37

List of Abbreviations

The MT Family Reference Manual¹ provides a list of abbreviations used across our MT documentation.

¹The latest available documentation can be found in your MT Software Suite installation folder or via the following link: <https://xsens.com/xsens-mti-documentation>

References

Abbreviation	Description
[FRM]	"MT Family Reference Manual", document id MT1600P
[LLCP]	"MT Low-Level Communication Protocol Documentation.pdf", document id MT0101P
[MFM]	"Magnetic Field Mapper Documentation.pdf", document id MT0202P
[MTM]	"MT Manager User Manual.pdf", document id MT0216P
[CAN]	"MT CAN Protocol Documentation", document ID MT1604P

Note: The latest available documentation can be found in your MT Software Suite installation folder or via the following link: <https://xsens.com/xsens-mti-documentation>

1 General information

This document provides information on the usage and technical details of the MTi 600-series modules and the MTi-680G. The MTi 600-series module (MTi-600) is a fully functional, self-contained module that is easy to design-in. The MTi-600 module can be connected to a host through RS232, CAN or UART interfaces, or through USB using the UART to USB converter (included in the MTi 600-series Development Kit). Whereas the MTi-680G is a rugged device with integrated RTK GNSS receiver.

The *MTi Family Reference Manual*¹ supplements this document. It reports generic information on the MTi 1-series and MTi 600-series, such as output definitions, algorithm details and installation tips.

The *MTi 600-series Hardware Integration Manual*² supplements this document. In this document, notes on typical application scenarios, printed circuit board (PCB) layout, origin of measurement reference system, stress related considerations, reference designs and handling information can be found.

For testing and prototyping, Xsens provides the MTi-630 and MTi-670 Development Kits (MTi-630-DK and MTi-670-DK) as well as a Starter Kit for the MTi-680G (MTi-680G-SK). In addition to the RS232, CAN and UART pin connectors of the MTi 600-series module, the Development Kit offers a direct USB, RS232, RS422 and CAN interface. Technical details of the Development Kit and its usage can be found in the *MTi 600-series DK User Manual*¹.

The *MT Low Level Communication Protocol*¹ document provides a complete reference for the protocols used to communicate with Xsens Motion Trackers on low-level basis. The MT Low Level Communication Protocol document also describes the synchronization messages and settings in detail.

Table 1 summarizes all available official documents for the Xsens MTi product line.

Table 1: MTi product documentation overview

MTi 1-series	MTi 600-series	MTi 10/100-series
MTi Family Reference Manual		MTi User Manual
MTi 1-series Datasheet	MTi 600-series Datasheet	
MTi 1-series DK User Manual	MTi 600-series DK User Manual	
MTi 1-series HW Integration Manual	MTi 600-series HW Integration Manual	
	MT CAN protocol Documentation	
MT Manager Manual		
Magnetic Calibration Manual		
MT Low Level Communication Protocol Documentation		
Firmware Updater User Manual		

² Links to the latest available documentation can be found via the following link: [Xsens MTi Documentation](#)

1.1 Ordering information

Table 2: Ordering information for MTi 600-series products

Part Number	Description	Packing
MTi-610	IMU Inertial data	Box (MOQ 5 units)
MTi-620	VRU Inertial data, roll/pitch/yaw (unreferenced)	Box (MOQ 5 units)
MTi-630	AHRS Inertial data, roll/pitch/yaw (referenced)	Box (MOQ 5 units)
MTi-670	GNSS/INS Inertial data, roll/pitch/yaw (referenced), velocity, position	Box (MOQ 5 units)
MTi-680G	RTK GNSS/INS Inertial data, roll/pitch/yaw (referenced), velocity, position	Box
MTi-630-DK	Development Kit for MTi-630 AHRS (also applicable for MTi-610 IMU and MTi-620 VRU)	Box
MTi-670-DK	Development Kit for MTi-670 GNSS/INS	Box
MTi-680G-SK	Starter Kit for MTi-680G RTK GNSS/INS	Box

1.2 MTi 600-series architecture

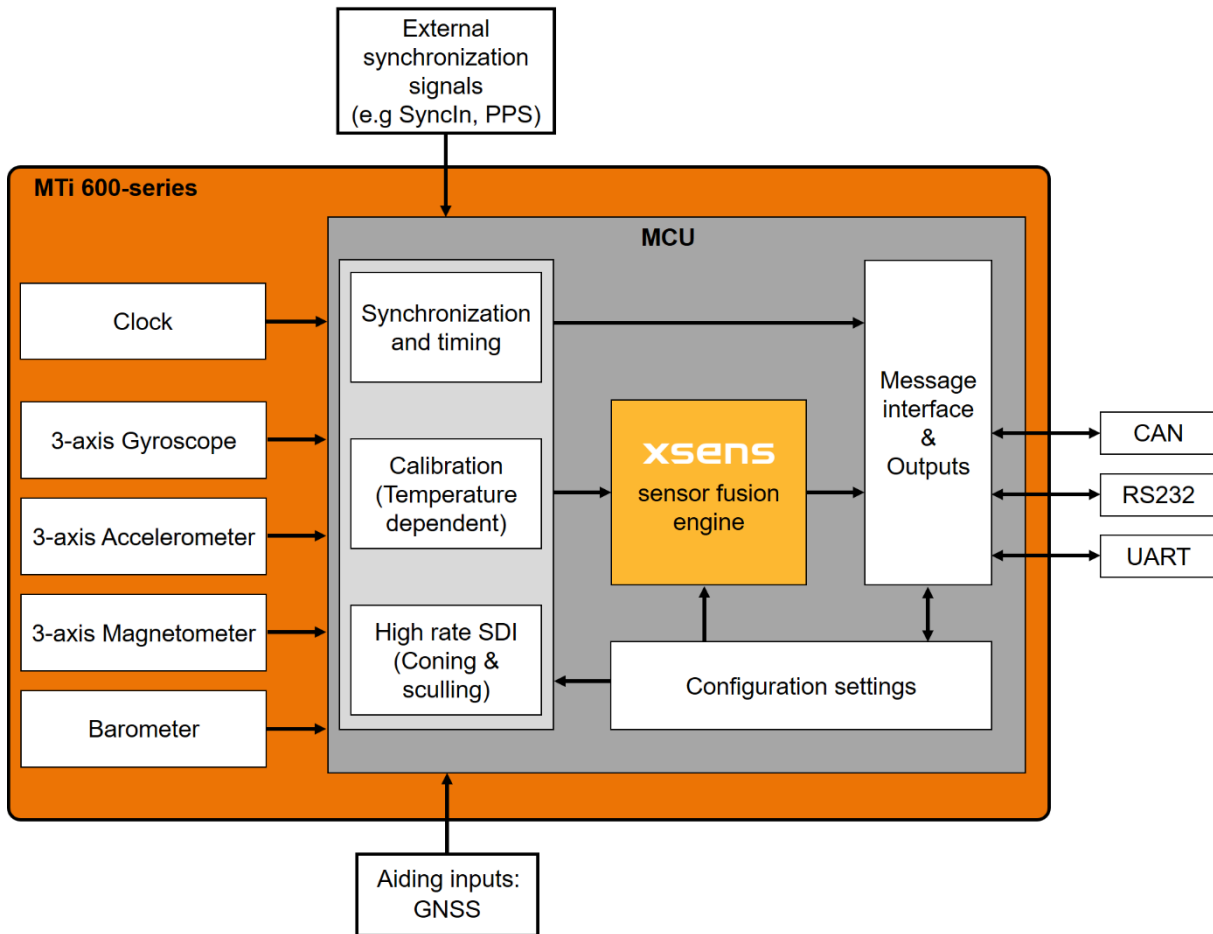

Figure 1: MTi 600-series module diagram

The diagram in Figure 1 shows a simplified architecture of the MTi 6x0-series module. The MTi-6x0 contains a 3-axis gyroscope, 3-axis accelerometer, 3-axis magnetometer, barometer, a high-accuracy crystal and a low-power micro controller unit (MCU). The MTi-670 module can also accept the signals from an external GNSS receiver. The MCU coordinates the timing and synchronization of the various sensors. The module offers the possibility to use external signals in order to accurately synchronize the clock and/or outputs of the MTi-6x0 with any user application. The MCU applies calibration models (unique to each sensor and including orientation, gain and bias offsets, plus more advanced relationships such as non-linear temperature effects and other higher order terms) and runs the Xsens optimized strapdown algorithm, which performs high-rate dead-reckoning calculations up to 2 kHz, allowing accurate capture of high frequency motions and coning & sculling compensation. The Xsens sensor fusion engine combines all sensor inputs and optimally estimates the orientation, position and velocity at an output data rate of up to 400 Hz. The output data of the MTi-600 is easily configured and

customized for an application's needs and can be set to use one of various filter profiles available within the Xsens sensor fusion engine. In this way, the MTi-600 limits the load and the power consumption on the user application's processor. The user can communicate with the module by means of three different communication interfaces; RS232, CAN and UART³. Other interfaces are available using an MTi Development Kit or by using third party equipment (e.g. UART/RS232 to USB converter).

Contrary to the above image, the MTi-680G includes an internal RTK enabled GNSS receiver. Which also provides PPS signals for synchronization purposes.

1.3 MTi 600-series product variants

The MTi-6x0 module is a fully tested self-contained module available as an:

- Inertial Measurement Unit (IMU),
- Vertical Reference Unit (VRU),
- Attitude and Heading Reference System (AHRS)
- GNSS aided Inertial Navigation System (GNSS/INS).

The MTi-680G is a fully tested self-contained rugged product with an integrated RTK GNSS/INS receiver.

It can output 3D orientation data (Euler angles, rotation matrix or quaternions), orientation and velocity increments (Δq and Δv), position and velocity quantities and calibrated sensor data (acceleration, rate of turn, magnetic field and pressure). Depending on the product variant, output options may differ.

1.3.1 MTi-610 IMU

The MTi-610 module is an IMU that outputs calibrated 3D rate of turn, 3D acceleration, 3D magnetic field and barometric pressure. The MTi-610 also outputs coning and sculling compensated orientation increments and velocity increments (Δq and Δv). Advantages over a simple gyroscope-accelerometer combo-sensor are the inclusion of synchronized magnetic field and barometric data, on-board signal processing and the easy-to-use synchronization and communication protocol. The signal processing pipeline and the suite of output options allow access to the highest possible accuracy at any output data rate up to 2000 Hz. Moreover, the testing and calibration is already performed by Xsens and results in a robust and reliable sensor module, which enables a short time to market for the users.

1.3.2 MTi-620 VRU

The MTi-620 is a 3D VRU. On top of the functionality of the MTi-610 IMU, its algorithm computes 3D orientation data with respect to a gravity referenced frame: drift-free roll, pitch and unreferenced yaw. Although the yaw is unreferenced, it is superior to only gyroscope integration as a result of advanced on-board sensor fusion. The 3D acceleration is also available as so-called free acceleration, which has the local-gravity subtracted. The drift in unreferenced heading can be limited by using the Active Heading

³ UART port is not available on MTi-680G

Stabilization (AHS) functionality, see Table 17 for more details. The raw sensor signals are combined and processed at a high frequency to produce a real-time data stream with device's 3D orientation (roll, pitch and yaw) up to 400 Hz.

1.3.3 MTi-630 AHRS

The MTi-630 supports all features of the MTi-610 and MTi-620, and in addition is a full magnetometer-enhanced AHRS. In addition to the roll and pitch, it outputs a true magnetic North referenced yaw (heading) and calibrated sensors data: 3D acceleration, 3D rate of turn, 3D orientation and velocity increments (Δq and Δv) and 3D earth-magnetic field data. The raw sensor signals are combined and processed at a high frequency to produce a real-time data stream with device's 3D orientation (roll, pitch and yaw) up to 400 Hz.

1.3.4 MTi-670 GNSS/INS

The MTi-670 provides a GNSS/INS solution offering a position and velocity output in addition to orientation estimates. The MTi-670 uses advanced sensor fusion algorithms developed by Xsens to synchronize the inputs from the module's on-board gyroscope, accelerometer, magnetometer and barometer, with the data from an external GNSS receiver. The raw sensor signals are combined and processed at a high frequency to produce a real-time data stream with device's 3D position, velocity and orientation (roll, pitch and yaw) up to 400 Hz.

1.3.5 MTi-680G RTK GNSS/INS

The MTi-680G provides a GNSS/INS solution offering a cm-level accurate position and velocity output (when correction signals are provided) in addition to orientation estimates. The MTi-680G uses an internal L1/L2 RTK enabled GNSS receiver.

2 Sensor specifications

This section presents the performance and the sensor component specifications for the calibrated MTi-6x0 series products. Each product has passed the Xsens calibration process individually. The Xsens calibration procedure calibrates for many parameters, including bias (offset), alignment of the sensors with respect to the PCB and to each other, and gain (scale factor). All calibration values are temperature dependent and temperature calibrated. The calibration values are stored in the non-volatile memory of the module.

In addition, some calibration parameters are continuously improved and/or re-estimated through the on-board sensor fusion algorithms during normal operation of the product.

2.1 MTi 600-series performance specifications

Table 3: Orientation performance specifications

Parameter	Condition	MTi-610 IMU	MTi-620 VRU	MTi-630 AHRS	MTi-670 GNSS/INS	MTi-680G RTK GNSS/INS
Roll/Pitch	Static	N/A	0.2°	0.2°	0.2°	0.2°
	Dynamic	N/A	0.5°	0.5°	0.5°	0.5°
Yaw	Dynamic	N/A	Unreferenc ed	1°	1°	1°

Table 4: Position and velocity performance specifications for MTi-670-DK

Parameter	Direction	Specification
Position	Horizontal	1.0 m
	Vertical	2.0 m
Velocity	3D	0.05 m/s

Table 5: Position and velocity performance specifications for MTi-680G with RTK correction signals provided

Parameter	Direction	Specification
Position	Horizontal	<0.05 m
	Vertical	0.1 m
Velocity	3D	0.05 m/s

All above specifications are RMS values based on typical application scenarios. The specifications mentioned in Table 3 and Table 4 are with MTi-630-DK and MTi-670-DK reference designs.

2.2 Sensor specifications

Table 6: MTi 600-series gyroscope specifications

Gyroscope specification ⁴	Unit	Value
Standard full range	[°/s]	±2000
In-run bias stability	[°/h]	8
Bandwidth (-3dB)	[Hz]	520
Noise density	[°/s/√Hz]	0.007
g-sensitivity (calibrated)	[°/s/g]	0.001
Non-linearity	[%FS]	0.1
Scale Factor variation	[%]	0.5 (typical) 1.5 (over life)

Table 7: MTi 600-series accelerometer specifications

Accelerometer ⁴	Unit	Value
Standard full range	[g]	±10
In-run bias stability (x, y)	[μg]	10
In-run bias stability (z)	[μg]	15
Bandwidth (-3dB)	[Hz]	500
Noise density	[μg/√Hz]	60
Non-linearity	[%FS]	0.1

Table 8: MTi 600-series magnetometer specifications

Magnetometer ⁴	Unit	Value
Standard full range	[G]	±8
Non-linearity	[%]	0.2
Total RMS noise	[mG]	1
Resolution	[mG]	0.25

Table 9: MTi 600-series barometer specifications

Barometer ⁴	Unit	Value
Full range	[hPa]	300-1250
Total RMS Noise	[Pa]	1.2
Relative accuracy	[Pa]	±8 ⁵

Table 10: MTi 600-series orthogonality specifications

Parameter ⁴	Unit	Value
Non-orthogonality (accelerometer)	[°]	0.05

⁴ As Xsens continues to update the sensors on the module, these specifications are subject to change.

⁵ Equivalent to 0.5 m.

	Non-orthogonality (gyroscope)	[°]	0.05
	Non-orthogonality (magnetometer)	[°]	0.05

Table 11: MTi-680G GNSS specifications

GNSS		Unit		Value
	Acquisition	Cold start	[s]	24 ⁶
		Hot start	[s]	2
	Convergence time	RTK	[s]	< 10 ⁷
	Horizontal pos. accuracy	PVT	[m]	1.5
		RTK ⁸	[m]	0.01
	Vertical pos. accuracy	RTK ⁸	[m]	0.01
Supported GNSS signals:				
	GPS	L1C/A	[MHz]	1575.42
		L2C	[MHz]	1227.60
	GLONASS	L1OF	[MHz]	1598.0 - 1605.4
		L2OF	[MHz]	1242.9 - 1248.6
	Galileo	E1-B/C	[MHz]	1575.42
		E5b	[MHz]	1207.14
	BeiDou	B1I	[MHz]	1561.098
		B2I	[MHz]	1207.14

⁶ Using GPS + GLONASS + Galileo + BeiDou.

⁷ < 30 s for GPS only.

⁸ Measured using 1 km baseline and patch antennas with good ground planes. Does not account for possible antenna phase center offset errors.

3 Functional description

This chapter describes the MTi-600 pinout and gives details about the supported communication interfaces.

3.1 Pin description module

The pin map shows the peripheral interfaces.

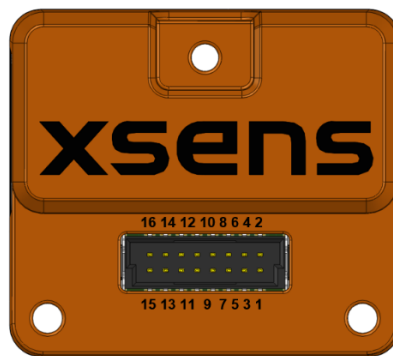

Figure 2: Pin configuration of the MTi 600-series module (bottom view)

Table 12: Pin descriptions of the MTi-600

Pin	Name	I/O type	Description
1	VIN	PWR	Power input
2	GND	PWR	Ground
3	CAN_H	I/O	CAN bus differential high side
4	CAN_L	I/O	CAN bus differential low side
5	RS232_TxD	O	RS232 transmitter output to host
6	RS232_RTS	O	RS232 Ready To Send output to host
7	RS232_RxD	I	RS232 receiver input from host
8	RS232_CTS	I	RS232 Clear To Send input from host
9	SYNC_IN1	I	Multifunctional synchronization input
10	SYNC_IN2	I	Multifunctional synchronization input
11	GNSS_TxD ⁹	O	RS232 transmitter output to GNSS module
12	GNSS_RxD ⁹	I	RS232 receiver input from GNSS module
13	SYNC_OUT	O	Configurable synchronization output
14	GND	PWR	Ground
15	UART_TxD	O	UART transmitter output
16	UART_RxD	I	UART receiver input

⁹ Only available for MTi-670. Do not connect for other models.

3.2 Pin description MTi-680G

Figure 3 show the three connectors on the rugged housing

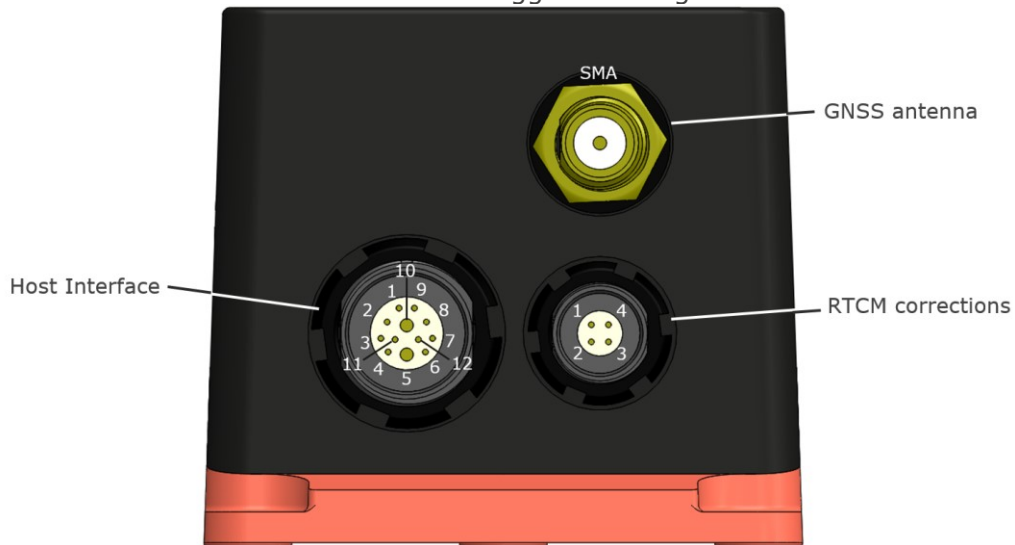

Figure 3 Connectors and pin numbers on the MTi-680G housing

Table 13 shows the pin descriptions of the MTi-680G Host Interface connector.

Table 13: Pin descriptions MTi-680G Host Interface

Pin	Name	I/O type	Description
1	CAN_H	I/O	CAN bus differential high side
2	CAN_L	I/O	CAN bus differential low side
3	SYNC_IN1	I	Multifunctional synchronization input
4	SYNC_IN2	I	Multifunctional synchronization input
5	VIN	PWR	Power input
6	RS232_CTS	I	RS232 Clear To Send input from host
7	RS232_RxD	I	RS232 receiver input from host
8	RS232_TxD	O	RS232 transmitter output to host
9	RS232_RTS	O	RS232 Ready To Send output to host
10	GND	PWR	Ground
11	SYNC_OUT	O	Configurable synchronization output
12	GND	PWR	Ground

Table 14 shows the pin descriptions of the MTi-680G RTCM corrections connector.

Table 14: Pin descriptions MTi-680G RTCM corrections

Pin	Name	I/O type	Description
1	V_BCKP	PWR	Backup supply for GNSS (3V3).
2	GND	PWR	Ground
3	RTCM_RxD	I	RS232 receiver input from host
4	RTCM_TxD	O	RS232 transmitter output to host

3.3 Peripheral interfaces

The MTi 600-series module supports CAN, RS232, and UART interfaces for host communication. For more detailed information on the interfaces please refer to the *MTi 600-series Hardware Integration Manual*¹⁰.

3.3.1 CAN (Controller Area Network)

A Controller Area Network (CAN bus) is a robust standard designed to allow communication between devices in applications without a host computer. The CAN interface of the MTi-600 does not include a termination resistor. It can be used in a CAN bus that already incorporates the required termination. If used in a single device connection, a 120 Ω termination resistor needs to be added between the CAN_H and CAN_L pins.

3.3.2 RS232 with RTS/CTS flow control

The RS232 interface complies with the standard RS232 voltage levels. It includes hardware flow control through RTS and CTS lines.

3.3.3 UART

The UART interface can be used to directly connect to an MCU with 3.3 V IO-levels. The user can configure the MTi 600-series module to communicate over UART. The UART frame configuration is 8 data bits, no parity and 1 stop bit (8N1). The UART protocol only has the TX and RX lines without any flow control. Due to the rugged build, the UART port is not available on MTi-680G devices.

3.3.4 RTCM input port

The RTCM input port on the MTi-680G can be used to provide RTCM correction messages. The port uses RS232 signalling with 8 data bits, no parity and 1 stop bit. The default baud rate on this port is 38400 bit/s, but a higher baud rate can be configured. Refer to Table 15 for available baud rates, and the low-level communication document for details on the SetPortConfig command to configure it.

Table 15 RTCM input port baud rates

baud rate [bit/s]
38k4 (default)
57k6
115k2
230k4
460k8
921k6

¹⁰ Links to the latest available documentation can be found via the following link: [Xsens MTi Documentation](#)

4 Signal processing and algorithms

This section discusses the MTi-600 series signal processing and algorithm description.

4.1 Signal processing pipeline

The MTi 600-series is a self-contained product, all calculations and processes such as sampling, coning & sculling compensation and the Xsens sensor fusion algorithm run on board.

4.1.1 Strapdown integration

The Xsens optimized strapdown algorithm performs high-rate dead-reckoning calculations up to 2000 Hz allowing accurate capture of high frequency motions. This approach ensures a high bandwidth. Orientation and velocity increments are calculated with full coning & sculling compensation. These orientation and velocity increments are suitable for any 3D motion tracking algorithm. Increments are internally time-synchronized with other sensors. The output data rate can be configured for different frequencies, see Table 19. The inherent design of the signal pipeline with the computation of orientation and velocity increments ensures there is absolutely no loss of information at any output data rate. This makes the MTi 600-series attractive also for systems with limited communication bandwidth.

4.1.2 Xsens sensor fusion algorithm for VRU and AHRS product types

MTi-620 and MTi-630 run the newest Xsens sensor fusion algorithm implementing the latest Xsens insights. It optimally estimates the orientation with respect to an Earth fixed frame utilizing the 3D inertial sensor data (orientation and velocity increments) and 3D magnetometer data.

The Xsens sensor fusion algorithm uses assumptions to obtain the orientation estimations. Since the assumptions may be more or less valid based on the characteristics of the typical dynamics of the application, and since the magnetic field differs per application, the Xsens algorithm makes use of a set of filter profiles to be able to use the correct assumptions given the application. This way, the algorithm can be optimized for different types of movements and conditions.

With the MTi-620 and MTi-630, the user can configure different algorithm behaviours by selecting a "base" filter profile and, next to it, a heading behaviour (see Figure 4). The "base" filter profile selection affects the general behaviour of the device, mainly based on the nature of the typical expected dynamics of the application. The heading behaviour, as the name suggests, affects the heading/yaw output of the MTi, and determines how the magnetometer measurements are interpreted. This tiered approach gives more freedom to select the desired behaviour for different user application scenarios. Table 16 and Table 17 summarize the filter profile and heading behaviour options.

Every application is different and results may vary from setup to setup. It is recommended to reprocess recorded data with different filter profiles in MT Manager¹¹ to determine the best filter profile for your specific application.

Table 16: Filter profiles for MTi-620 and MTi-630

Name	Product	Description	Typical applications
Responsive	MTi-620 MTi-630	This filter profile is designed for indoor applications as well as applications that experience high dynamics and jerky movements. When the MTi is static, an automatic gyro bias estimation is performed in the background.	<ul style="list-style-type: none"> • Outdoor/Indoor handling objects • Indoor ground vehicles • Outdoor/Indoor head tracker • Indoor mapping, outdoor mapping if handheld (e.g. tripods with camera, backpack) • Industrial robotic arm
Robust	MTi-620 MTi-630	This filter profile is suitable for most of the applications. Compared to the other filter profiles it has a more robust tuning. When the MTi is static, an automatic gyro bias estimation is performed in the background.	<ul style="list-style-type: none"> • Ships/vessels • Automotive • Ground vehicles outdoor • Outdoor mapping with vehicles
General ¹²	MTi-620 MTi-630	This filter profile behaves like the General filter profile implemented for the previous generation Xsens Products (e.g. MTi-30). It is more sensitive to the magnetic field changes. It does not perform an automatic gyro bias estimation in background. This filter profile cannot be combined with the FixedMagRef heading behaviour.	<ul style="list-style-type: none"> • Automotive • Ground vehicles outdoor • Outdoor mapping with vehicles

¹¹ [Recording a data file to be reprocessed in MT Manager](#)

¹² The General filter profile is only recommended for users who are looking for similar behaviour as the previous generation Xsens products in the typical applications suggested in the table. Using the General filter profile is not recommended for new designed applications.

Table 17: Heading Behaviour

Name	Product	Description	Typical applications
NorthReference	MTi-630	This heading behaviour assumes a homogeneous magnetic environment that can be used to estimate a stable North referenced heading.	All applications that require a North referenced heading and are used in a homogeneous magnetic field.
FixedMagRef	MTi-630	This heading behaviour is based on the idea that the heading is not necessarily referenced to the local magnetic North. Instead, it maintains a fixed heading reference frame based on what is defined when the MTi is powered up (based on the initially observed magnetic field). This means that there is no drift with respect to the starting frame when the local magnetic field changes. For example, when moving from room A to room B, where room B has a different local magnetic field direction than room A, the heading output of the MTi does not change. This is in contrast to the NorthReference heading behaviour, which forces the MTi to estimate the heading based on the local magnetic field.	All applications that are used in environments where different magnetic fields are present (e.g. mixed indoor/outdoor applications).
VRU	MTi-620 MTi-630	The yaw is unreferenced. This means that it is initialized at 0° when the MTi is powered up and the yaw will be computed relative to this initial orientation. The magnetic field is not used to estimate the yaw. Because of small inaccuracies that originate when integrating gyroscope data, the Yaw output will contain an error that builds up over time, also known as "drift". Note however, that because of the working principle of the sensor fusion algorithm, the drift in yaw will be much lower than when gyroscope signals would be simply integrated.	Applications where only roll and pitch is of interest and/or applications that are used in environments where the magnetic field cannot be trusted (e.g. stabilized antenna platforms or pipeline inspection tools).
VRUAHS	MTi-620 MTi-630	This heading behaviour activates the Active Heading Stabilization (AHS) on top of the above described VRU behaviour. AHS is a software component within the sensor fusion engine designed to give a low-drift unreferenced heading solution, even in a disturbed magnetic environment. The yaw remains unreferenced, but the drift is limited ¹³ .	Scenarios where the magnetic field cannot be trusted completely, but a stable yaw is needed.

¹³ For more information on the capabilities of AHS, refer to the BASE article: [AHS](#). Note that in the previous Xsens products, AHS was activated by means of a separate setting.

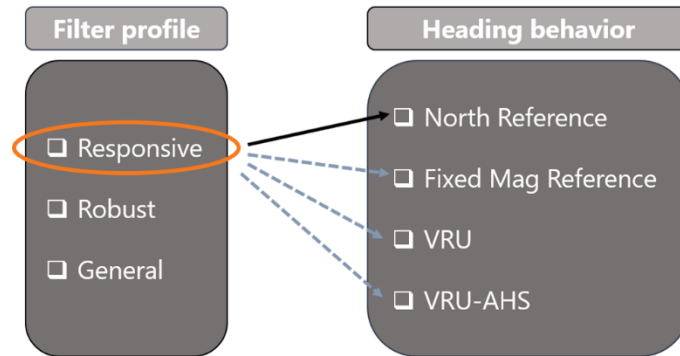

Figure 4: Filter profile and heading behaviour selection: a tiered approach

4.1.3 Xsens sensor fusion algorithm for the GNSS/INS product type

The Xsens sensor fusion algorithm in the GNSS/INS products has several advanced features. The algorithm adds robustness to the orientation and position estimates by combining measurements and estimates from the inertial sensors, magnetometer, barometer and a GNSS receiver in order to compensate for transient accelerations and magnetic disturbances.

The GNSS status is continuously monitored and the filter accepts GNSS data when available and sufficiently trustworthy. When the product has limited/mediocre GNSS reception or even no GNSS reception at all (e.g. during outages), the fusion algorithm seamlessly adjusts the filter settings in such a way that the highest possible accuracy output is maintained. The MTi will continue to output position, velocity and orientation estimates, although the accuracy is likely to degrade over time as the filters can only rely on dead-reckoning. If the GNSS outage lasts longer than 45 seconds, the MTi stops the output of the position and velocity estimates, and resumes sending these outputs once the GNSS data becomes acceptable again.

Smoothers

The GNSS/INS products (MTi-670 and MTi-680G) have optional sensor fusion functions called *smoothers* for reducing sudden jumps in the output data that may arise from fusing low-rate GNSS receiver messages with high-rate inertial sensor data. There is a smoother for orientation data for both the MTi-670 and MTi-680G, and a position/velocity smoother for the MTi-680G. The smoothers can be enabled from the Device Settings window in MT Manager, or by using the `setOptionFlags` low-level communication command (see [LLCP] for details).

Lever Arm Correction

Due to the improvement in position accuracy on MTi-680G devices with RTK support, the option to configure a GNSS lever arm is available. Figure 6 highlights the effect of the lever-arm on measurements taken with cm level accuracy.

The lever-arm describes the position of the GPS antenna with respect to the origin of measurement of the MT device (see page 37). The algorithm uses this information to correct its position and velocity measurements accordingly. The lever-arm can be set from the Device Settings window in MT-Manager, or by using the `setGnssLeverArm` low-level communication command (see [LLCP] for details).

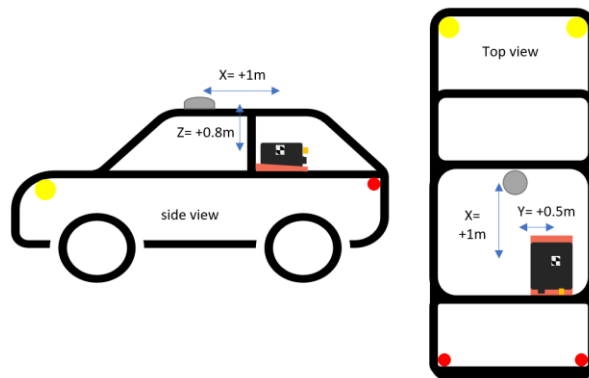

Figure 5: Example of lever arm measurements

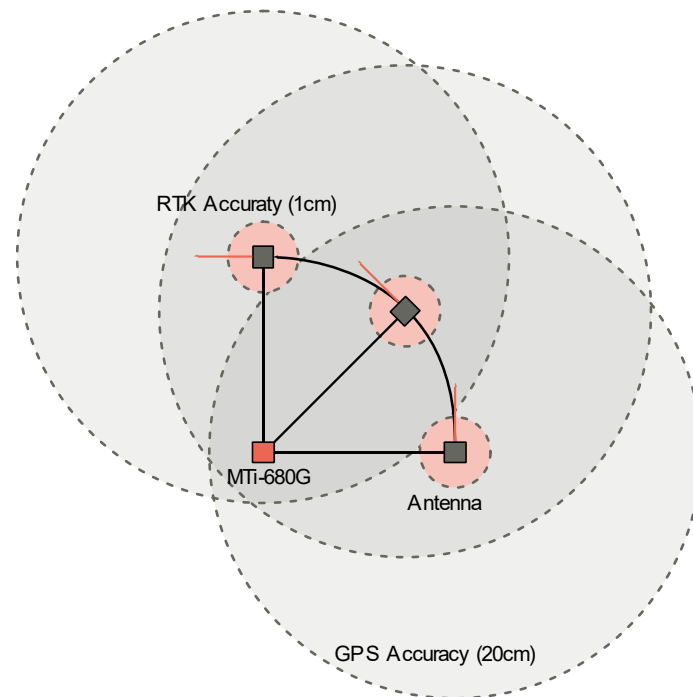

Figure 6: Lever arm correction for MTi-680G

Filter profiles

Table 18 reports the different filter profiles the user can set based on the application scenario. Every application is different and results may vary from setup to setup. It is recommended to reprocess recorded data with different filter profiles in MT Manager¹⁴ to determine the best results in your specific application.

¹⁴ [Recording a data file to be reprocessed in MT Manager](#)

Table 18: Filter profiles for MTi-670 and MTi-680G (GNSS/INS)

Name	GNSS ¹⁵	Barometer	Magnetometer	Description
General / General_RTK	●	●		This filter profile is the default setting. The yaw output of the MTi is North referenced (when GNSS data is available). Altitude (height) is determined by combining static pressure, GNSS altitude and accelerometers. The barometric baseline is referenced by GNSS, so during GNSS outages, accuracy of height measurements is maintained.
GeneralNoBaro / GeneralNoBaro_RTK	●			This filter profile is very similar to the general filter profile except for the use of the barometer.
GeneralMag / GeneralMag_RTK	●	●	●	This filter profile bases its yaw estimate mainly on magnetic heading and GNSS measurements. A homogenous magnetic environment and a proper magnetic calibration are essential for a good performance. This filter profile produces a North referenced yaw output directly after powering up the MTi.

Real-Time Kinematics

The MTi-680G supports centimetre level position accuracy through RTK (Real-Time Kinematic) positioning, which uses correction messages from a base station with a known position. The RTK correction data must be supplied as RTCM3 messages, either via the dedicated RTCM input connector (see Figure 3) or via the host interface as RTCM messages embedded in xbus (see XMID_ForwardGnssData in the low-level communication documentation). In the later case, the NTRIP client in MT-Manager can be setup to provide the correction data.

4.2 Data output

The MTi 600-series product variants can output many different data types at many different frequencies. Below is a summary of the most relevant data and maximum output data rates. A full overview is available in the *MT Low Level Communication Protocol Documentation*¹⁶.

¹⁵ External GNSS receiver (position aiding sensor) for the MTi-670

¹⁶ Links to the latest available documentation can be found via the following link: [Xsens MTi Documentation](#)

Table 19: Output data rates

Data Type	Max Output Data Rate
Orientation data (Euler angles, Rotation Matrix, Quaternions)	400Hz
Position, Velocity, Altitude	400Hz
DeltaQ, DeltaV	400Hz
Acceleration, Rate of Turn, Free Acceleration	400Hz
Acceleration HR (High Rate)	2000Hz
Rate of Turn HR (High Rate)	1600Hz

4.2.1 Xbus output

The Xbus protocol is Xsens' standard output protocol utilizing the MTDATA2 data message structure. This output provides a lot of flexibility and enables users to access all functionality of the MTi product range. The Xbus output format is shared with all other MTi products in the Xsens portfolio, so switching between hardware platforms is very easy. More information is available in the *MT Low Level Communication Protocol Documentation*⁸.

4.2.2 NMEA output

NMEA output is a string output mode which outputs data in the commonly used NMEA 0183 format. More information is available in the *MT Low Level Communication Protocol Documentation*⁸.

4.2.3 CAN output

The CAN output is an industrial standard interface over which the MTi 600-series can output its data. More information on this output can be found in the *MT Low Level Communication Protocol Documentation*⁸ and *Family Reference Manual*⁸.

4.3 GNSS input

The MTi-670 requires GNSS receiver data to provide a full GNSS/INS solution. This can be achieved by using the UBX protocol (uBlox proprietary protocol) or with NMEA input.

When connecting a uBlox receiver (e.g. uBlox MAX-M8), the MTi will configure it correctly on start-up. No prior configuration of the uBlox receiver is required. It is however recommended to inform the MTi of what type of uBlox receiver is connected. An Xbus message called SetGnssReceiverSettings, described in the *MT Low Level Communication Protocol Documentation*, can be used to select one of the officially supported uBlox receiver series: MAX-M8 (default), NEO-M8 or ZED-F9.

Alternatively, NMEA input or simply NMEAin is a functionality that allows the input of data from an external GNSS receiver using the NMEA protocol. As almost all GNSS receivers support the output of NMEA messages, this functionality enables the use of virtually any GNSS receiver.

It is important to note that both the GNSS receiver and the MTi must be configured prior

to connecting both systems to each other. The NMEAin for the MTi-670 can be enabled through the SetGnssReceiverSettings Xbus message, described in the *MT Low Level Communication Protocol Documentation*.

Table 20 summarizes the settings needed to configure the MTi-670 to use the NMEAin option. This will enable the MTi-670 to use the GNSS data and provide the user with a full GNSS/INS solution. The MTi-670 will also sync its internal clock to the UTC time that is present in the sentences.

Table 20: Settings required to enable NMEAin for the MTi-670

Setting	Description
Baudrate	Minimum 115200 bps
GNSS Message frequency	4 Hz
Talker ID	GN, GP or GL
Required messages	GGA, GSA, GST and RMC High precision coordinate formats such as GGALONG are also supported

4.4 Magnetic interference

Magnetic interference can be a major source of error for the heading accuracy of any AHRS, as an AHRS uses the magnetic field to reference the estimated orientation on the horizontal plane with respect to the (magnetic) North. A severe and prolonged distortion in that magnetic field will cause the magnetic reference to be inaccurate. The MTi 600-series has several ways to cope with these distortions to minimize the effect on the estimated orientation, which are discussed in the sections below.

4.4.1 Magnetic Field Mapping (MFM)

When the distortion moves with the MTi (i.e. when a ferromagnetic object solidly moves with the MTi module), the MTi can be calibrated for this distortion. Examples are the cases where the MTi is attached to a car, aircraft, ship or other platforms that can distort the magnetic field. It also handles situations in which the sensor has become magnetized. These type of errors are usually referred to as soft and hard iron distortions. The Magnetic Field Mapping procedure compensates for both hard iron and soft iron distortions.

The magnetic field mapping (calibration) is performed by moving the MTi mounted on the object/platform that is causing the distortion. The results are processed on an external computer (Windows or Linux), and the updated magnetic field calibration values are written to the non-volatile memory of the MTi 600-series. The magnetic field mapping procedure is extensively documented in the *Magnetic Calibration Manual*¹⁷.

¹⁷ Links to the latest available documentation can be found via the following link: [Xsens MTi Documentation](#)

4.5 Frames of reference

The MTi 600-series uses a right-handed coordinate system. The default sensor-fixed frame (S_{xyz}) is defined as shown in Figure 7 (module) and Figure 8 (MTi-680G). The frame is also printed on the side of the module (back side of MTi-680G). For a more exact location of the sensor frame origin, refer to Section 7.1. When the sensor is rigidly attached to another object or vehicle, it is possible to rotate the sensor-fixed frame S_{xyz} to an object coordinate frame (O_{xyz})¹⁸. The default local earth-fixed frame (L_{XYZ}) is East-North-Up (ENU). In addition, the MTi-6x0 has predefined output options for North-East-Down (NED) and North-West-Up (NWU). For specifically the MTi-670, the Local Tangent Plane (LTP) is a local linearization of the Ellipsoidal Coordinates (Latitude, Longitude, Altitude) in the WGS-84 Ellipsoid, based on the real time position data retrieved from the GNSS receiver. Since the MTi-620 and MTi-630 cannot receive real time positioning from a GNSS receiver, the user must set correct positional coordinates to allow the MTi-620 or MTi-630 to construct the reference frame, magnetic and gravity models.

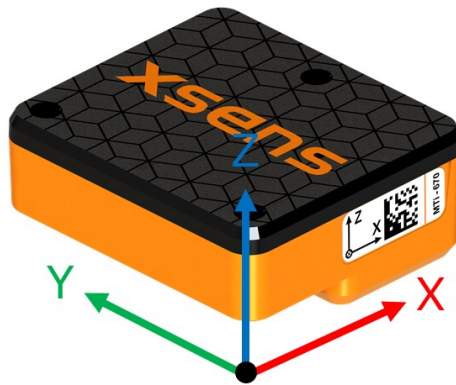

Figure 7 Default sensor fixed coordinate system (S_{xyz}) for the MTi 600-series module

¹⁸ How to define a new object coordinate system can be found in the *MTi Family Reference Manual*

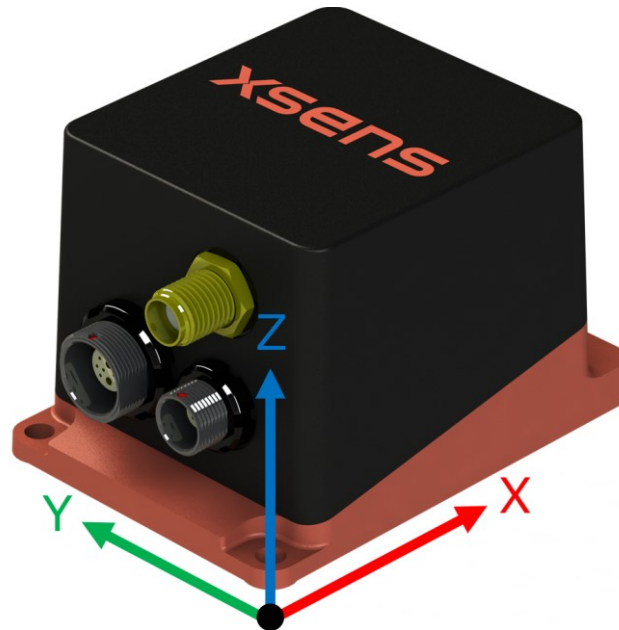

Figure 8: Default sensor coordinate system for the MTi-680G

5 Synchronization options

This chapter describes the synchronization functionalities of the MTi-600 series. In the remainder of this chapter, synchronization will be abbreviated as sync, synchronization input as SyncIn and synchronization output as SyncOut. A set of one or more synchronization options and their corresponding parameters are stored in a structure referred to as SyncSettings.

The sync functionalities are in line with the other Xsens motion trackers, however, some minor differences exist because of the different architecture of the MTi-600.

The MTi-600 series has two input lines available for SyncIn, and one for SyncOut (see Table 12). It is not possible to configure a SyncIn line as SyncOut or vice versa.

On devices which employ an external GNSS receiver, a 1PPS signal can be gathered directly from the GNSS receiver. However, it is also possible to configure a 1 Hz output reference signal using the SyncOut functionalities. The output reference signal is synchronized with the 1PPS signal of the external GNSS receiver when using an MTi-670, or the internal GNSS receiver when using an MTi-680G.

5.1 Trigger signal

A trigger signal is expected to be a pulse wave (See Table 27 for the trigger signal requirements). When using a SyncIn function the trigger is an input signal. When using a SyncOut function it is a output signal generated by the MTi. When configuring a sync function, various parameters can be set by the user to interpret/generate the trigger signal. This parameters are reported in Table 21.

Table 21: Generic synchronization parameters

Parameter	Description
Line	Defines the physical line to be used for the sync function. Valid values: <ul style="list-style-type: none">• In1• In2• ReqData• Out1 All SyncIn functions can be employed on both input lines. If a function has to be enabled on both SyncIn lines, the functions must be included twice in the configuration settings, i.e. once for each line. ReqData is specifically used for the Send Latest function.
Polarity	Valid values: <ul style="list-style-type: none">• Rising edge: the trigger is sensitive to the rising edge of the pulse wave• Falling edge: the trigger is sensitive to the falling edge of the pulse wave• Falling & Rising edge: the trigger is sensitive to both edges
SkipFirst	Ignore the first "n" input triggers.
SkipFactor	Periodically skips every n input triggers. This skipping starts after the "n" SkipFirst pulses.
Trigger Once	If the Once option is set, the sync function is only triggered once and the following pulses are ignored. The Once feature is considered only after the SkipFirst count is reached. Its state is reset when the MTi enters a new Measurement mode.

Pulse width	Pulse duration in microseconds.
Delay	Delay in microseconds to react at the trigger event.

5.2 SyncIn

This chapter describes the functionality and behaviour of the SyncIn line. The SyncIn lines can be used to synchronize the sampling of data or data output of the MTi 600-series to an external device or clock by inputting a trigger signal through the SyncIn lines. See Table 27 for the trigger signal requirements.

5.2.1 TriggerIndication function

With this function the user can input a trigger signal to mark the output data (e.g. orientation) with the trigger event. Upon receiving a trigger, this function will set the trigger indication status bit (SyncIn Marker) of the Status Word to 1. Furthermore, the user can configure the MTi to output also a TriggerIndication message through the MtData2 stream. The advantage is that this message is timestamped with the trigger moment, so it has better accuracy than just the status flag.

5.2.2 SendLatest function

Enabling this function, the last measured/computed desired data available at the trigger instant is outputted by the MTi. The internal signal pipeline of the MTi works as usual, but the desired data is outputted only when a trigger is received.

The trigger can be sent either on a SyncIn line or by means of a software command (Line must be set to ReqData).

5.2.3 StartSampling function

When this function is enabled, the device will start outputting data after a SyncIn trigger has been received. It does not trigger every consequent sample, but it accurately starts outputting the first sample, after which the next samples will follow the selected output data rate. A skipFirst value can be set to ignore the first n pulses before considering a pulse as a trigger.

Similarly, a delay parameter can be set to tune when to start the sampling after the trigger.

5.2.4 Clock Bias Estimation function

This function enables the user to synchronize the sampling clock of the MTi with an external reference signal. The internal clock of the MTi-600 has an accuracy of about 10 ppm. When a reference clock of better accuracy is available, it is possible to use this clock to improve the sampling accuracy of the MTi-600. Furthermore, it could be beneficial to have all devices in a setup to run at the same clock speed.

If the user does not have a reference clock that is better than 10 ppm, but it is still preferred to run multiple devices at the same clock speed, it is better to use the SyncOut line of the MTi-600 as a clock source for other devices.

On the MTi-680G the internal clock is always referenced to the internal GNSS receiver. Therefore, on the MTi-680G the clock bias estimation is not user configurable.

5.2.5 1PPS Time-pulse function

When an MTi-670 is connected with an external GNSS receiver, the 1PPS signal of the receiver can be used as input to synchronize the MTi-670 with the external receiver. Not available on MTi-610/MTi-620/MTi-630. On the MTi-680G this function is always enabled with the time pulse from the internal GNSS receiver.

5.3 SyncOut

The MTi 600-series has one output synchronization function.

5.3.1 Interval Transition Measurement function

The *Interval Transition Measurement* function gives a sampling time indication letting the user to synchronize external applications with the same clock employed by the MTi-600 to output the data. It generates a SyncOut trigger based on the internal 400 Hz SDI sampling clock.

5.4 Combining multiple Sync functions

The following list of possible sync functions are available:

- ClockSync [in]
- TriggerIndication [in]
- SendLatest [in]
- StartSampling [in]
- Interval Transition Measurement [out]

Table 22: Remarks on combining multiple Sync functions

Function	Description
ClockSync	If ClockSync is configured on a SyncIn line, no other function can be configured on this line at the same time.
TriggerIndication	Is a somewhat passive function in the sense that it does not change the state or timing of the system. It can therefore be freely combined with all other functions. It can also be configured on both SyncIn lines with different settings.
SendLatest/StartSampling	Only one of these functions can be active and only on one line.
SamplingIndication	Can be configured next to all possible SyncIn functions.

6 System and electrical specifications

6.1 Interface specifications

Table 23: Communication interfaces

Interface	Symbol	Min	Typ	Max	Unit	Description
CAN	f_{CAN}	10.0	250.0	1000	kbps	Host CAN Interface Baud Rate
RS232	f_{RS232}	4.8	115.2	1000	kbps	Host RS232 Interface Baud Rate
UART ¹⁹	f_{UART}	4.8	115.2	2000	kbps	Host UART Interface Baud Rate

6.2 System specifications

Table 24: System specifications of MTi 600-series modules

		Min	Typ	Max	Unit	Comments
Size	Width		31.5		mm	
	Length		28.0		mm	
	Height		13.0		mm	
Weight			8.9		gram	
Temperature	Operating temperature	-40		+85	°C	Ambient temperature, non-condensing
Power consumption		310	340	530	mW	Depends on used interface and supplied voltage. 5V over UART is most power efficient
Timing accuracy			10		ppm	Output clock accuracy of 1 ppm can be achieved with the MTi-670 with external GNSS module
MTBF GM			40.000		hours	
MTBF GB			360.000		hours	
Output data rate			400	2000	Hz	Data rates larger than 400 Hz available for RateOfTurnHR (1600 Hz) and AccelerationHR (2000 Hz) only

Table 25: System specifications of MTi-680G

		Min	Typ	Max	Unit	Comments
Size	Width		40.9		mm	
	Length		56.5		mm	58.1 mm including SMA connector
	Height		36.8		mm	
Weight			98		gram	
IP-rating			IP68			48 hours at 1 meter under water
Temperature	Operating temperature	-40		+85	°C	Ambient temperature, non-condensing

¹⁹ Not available on MTi-680G.

Power consumption		620	720	1000	mW	Depends on used interface and supplied voltage.
Timing accuracy			1		ppm	
Output data rate			400	2000	Hz	Data rates larger than 400 Hz available for RateOfTurnHR (1600 Hz) and AccelerationHR (2000 Hz) only

6.3 Electrical specifications

Table 26: Supply voltage specifications

Symbol	Min	Typ	Max	Unit	Description
V_{IN}	4.5	5	24	V	Power input voltage
V_{BCKP}^{20}	1.7	3.0	3.6	V	GNSS backup input voltage

Table 27: I/O electrical specifications

I/O interface	Symbol	Min	Typ	Max	Unit	Description
CAN	$V_{I(DIFF)(R)}$	-4.0		0.5	V	Recessive differential input voltage $-12V < V_{(CANH, CANL)} < +12V$
	$V_{I(DIFF)(D)}$	0.9		9.0	V	Dominant differential input voltage $-12V < V_{(CANH, CANL)} < +12V$
	$V_{O(DIFF)(R)}$	-500	0	50	mV	Recessive differential output voltage
	$V_{O(DIFF)(D)}$	1.3	2.0	5.0	V	Dominant differential output voltage
	$V_{O(L)(D)}$	0.5	1.5	2.25	V	CAN_L dominant output voltage
	$V_{O(H)(D)}$	2.75	3.5	4.5	V	CAN_H dominant output voltage
RS232 ²¹ (GNSS/RTCM)	V_{IL}	-25		0.6	V	Low input voltage
	V_{IH}	2.4		+25	V	High input voltage
	V_{OT}	±5	±5.4		V	Driver Output Voltage swing
UART ²²	V_{IL}	0		0.88	V	Low input voltage
	V_{IH}	2.29		3.6	V	High input voltage
	V_{OL}	0		0.44	V	Low output voltage
	V_{OH}	2.6		3.3	V	High output voltage
SYNC_IN1/ SYNC_IN2	V_{IL}	-25		0.6	V	Low input voltage
	V_{IH}	2.4		+25	V	High input voltage
SYNC_OUT	V_{OL}	0		0.44	V	Low output voltage
	V_{OH}	2.6		3.3	V	High output voltage
	I_O			±4	mA	Output current

²⁰ Only available on MTi-680G.

²¹ Also applies to the GNSS (MTi-670) and RTCM (MTi-680G) ports.

²² Not available on MTi-680G.

6.4 Absolute maximum ratings

Table 28: Absolute maximum ratings MTi 600-series module

Parameter		Min	Max	Unit	Comments
Storage temperature	T_S	-40	+90	°C	
Operating temperature	T_O	-40	+85	°C	
Power input voltage ²³	V_{IN}	-0.3	30	V	
CAN DC ²³	V_{CAN_DC}	-58	58	V	Common mode voltage of CAN_H and CAN_L with respect to ground
CAN Differential	V_{CAN_DIFF}	-17	17	V	Differential voltage between CAN_H and CAN_L
RS232 inputs ²³	V_{RS232}	-25	25	V	
SYNC inputs ²³	V_{SYNC}	-25	25	V	
SYNC output	I_{SYNC}		±20	mA	SYNC output current
UART input ²³	V_{UART}	-0.3	3.6	V	
Acceleration ²⁴			10,000	g	Any axis, unpowered, for 0.2 ms
ESD protection			±8000	V	Human body model

Stresses beyond those listed under “Absolute Maximum Ratings” may cause permanent damage to the device. These are stress ratings only. Functional operation of the device at these or any other conditions beyond those indicated in the operational sections of the specifications is not implied. Exposure to absolute maximum rating conditions for extended periods may affect device reliability. Particular attention must be paid handling the device. Torques on the connector of the MTi 600-series must be avoided at all times.

²³ All voltages with respect to GND

²⁴ Δ This is a mechanical shock (g) sensitive device. Proper handling is required to prevent damage to the part.

7 Design and packaging

7.1 Design

Figure 9 shows the dimensions of the MTi-600 module together with the origin of measurements (located by the  symbol). More information about the mounting options and recommended mating/mounting parts can be found in the *MTi 600-series Hardware Integration Manual*²⁵. Figure 10 shows the same information for the MTi-680G.

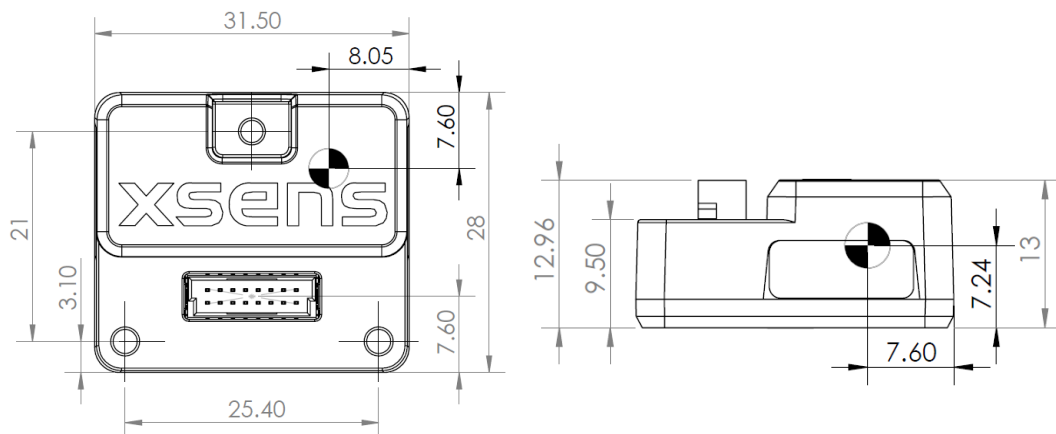

Figure 9: Location origin of measurements MTi-600 module (dimensions in mm)

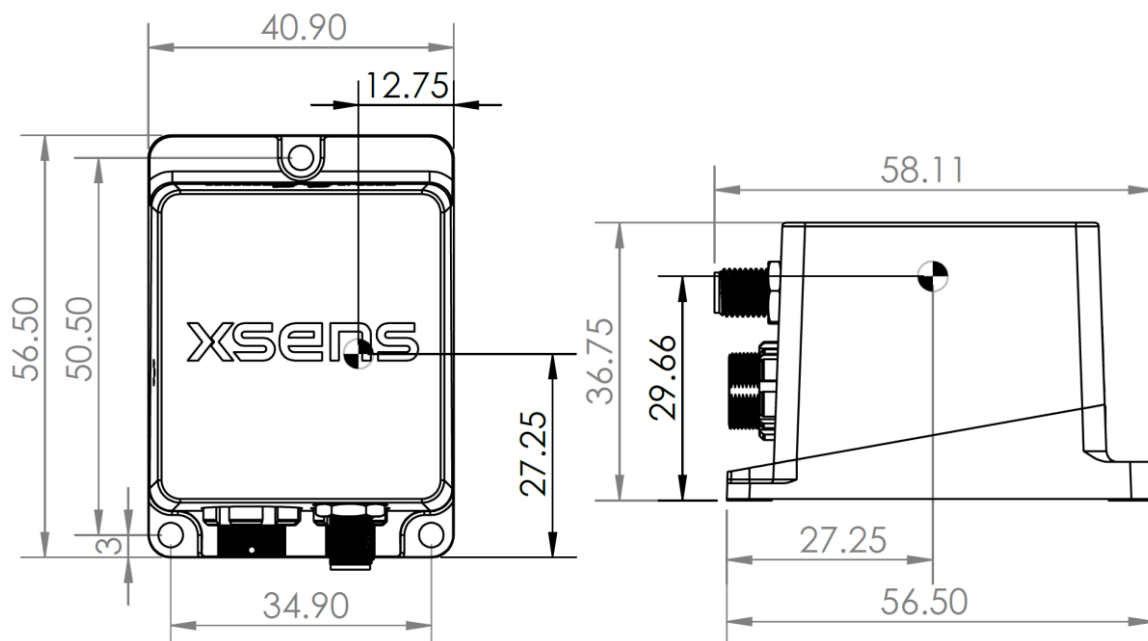

Figure 10: Location origin of measurements MTi-680G (dimensions in mm)

²⁵ Links to the latest available documentation can be found via the following link: [Xsens MTi Documentation](#)

7.2 Packaging information

7.2.1 MTi 600-series module

The MTi 600-series module packaging boxes contain from 5 up to 20 modules.

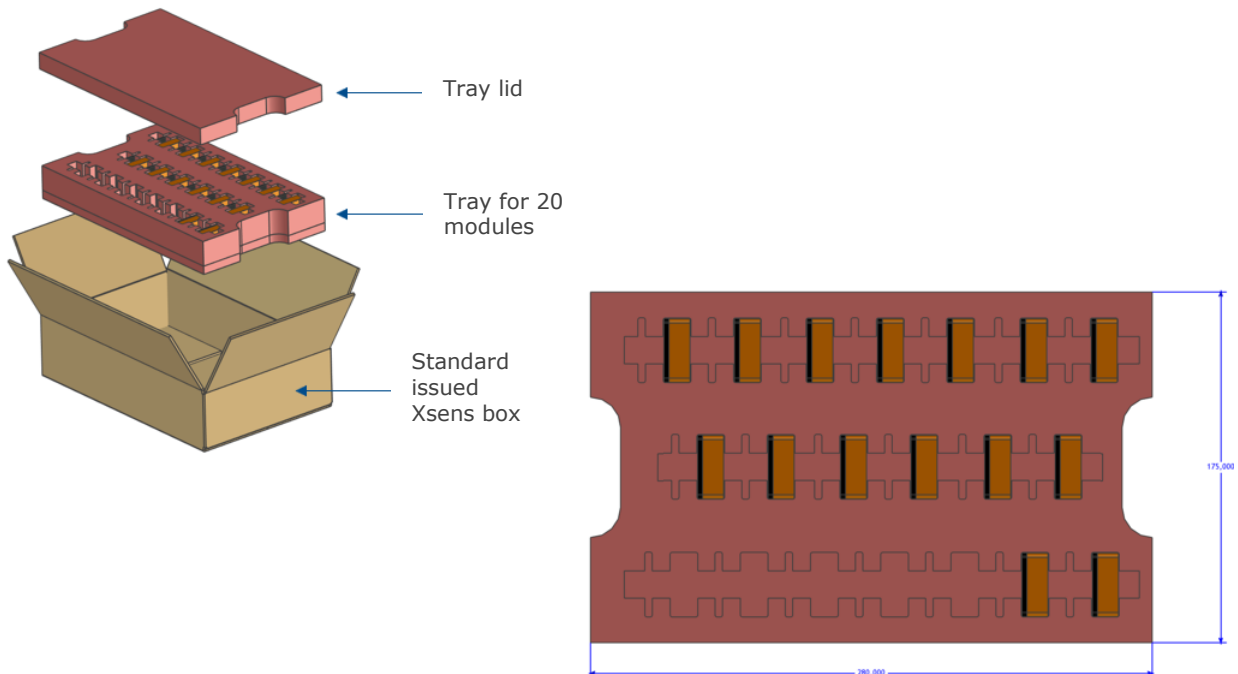

Box Dimensions (mm)			Box packaging information	
Length	Width	Height	Qty/Tray MOQ 5	Qty/Box MOQ 5
285	185	75	5-20 units	5-20 units

NOTES:

- All dimensions are in millimeters.
- Pictured tray and box representative only, actual tray may look different.

CONTENT:

- 5 to 20 modules per box.
- Calibration certificate.

7.2.2 MTi-680G

The MTi-680G packaging boxes contain from 1 up to 9 MTi-680G's.

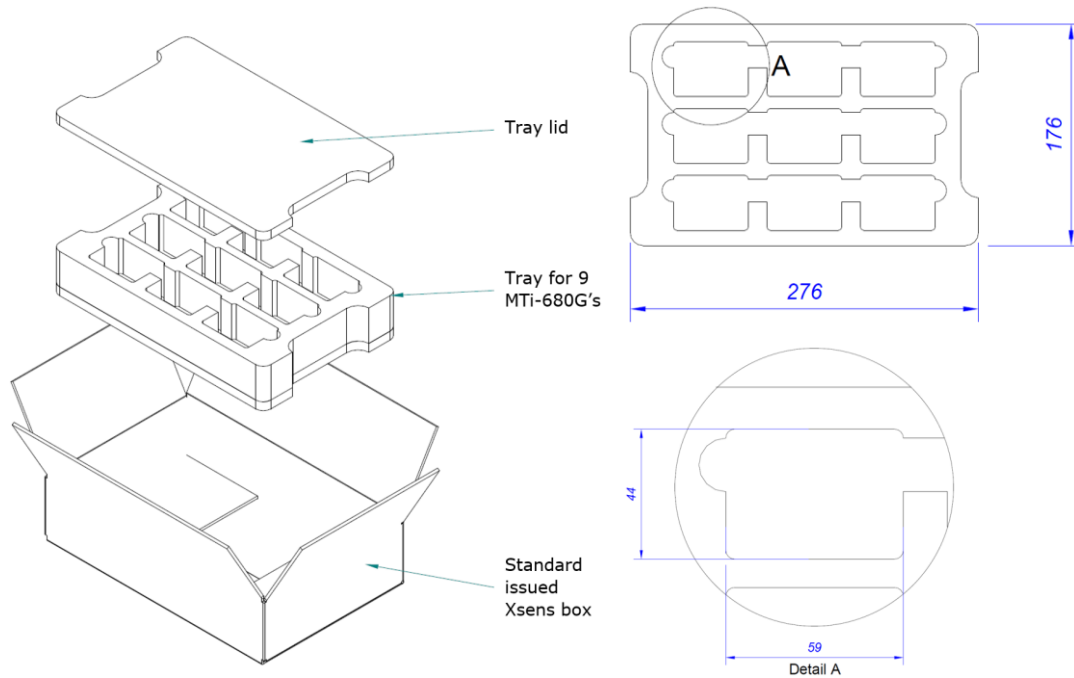

Box Dimensions (mm)			Box packaging information	
Length	Width	Height	Qty/Tray MOQ 1	Qty/Box MOQ 1
285	185	75	1-9 units	1-9 units

NOTES:

- All dimensions are in millimeters.
- Pictured tray and box representative only, actual tray may look different.

CONTENT:

- 1 to 9 MTi-680G's per box.
- Calibration certificate.

8 Declaration of conformity

8.1 EU Declaration of Conformity MTi-600 module

EU Declaration of Conformity

Applicable objects:

MTi-610¹
MTi-620¹
MTi-630¹
MTi-670¹
MTi-6##-DK

Manufacturer:

Xsens Technologies B.V.
Pantheon 6a
7521 PR ENSCHEDE
THE NETHERLANDS

This declaration of conformity is issued under the sole responsibility of the manufacturer.

The objects of the declaration described above are in conformity with the relevant Union harmonization legislation, based on the tested mode of operation(s), the applicable performance criteria, and specified acceptance criteria:

Short name	Directive
Electromagnetic compatibility (EMC)	2014/30/EU
Restriction of the use of certain hazardous substances (RoHS)	2011/65/EU

Relevant harmonized standards used:

Standard description	Standard	Result
Emission	EN 61326-1 (2013), class B	Passed
Immunity	EN 61326-1 (2013), Industrial	Passed
Radiated emission up to 1 GHz (SAC)	EN 55011 (2009) + A1 (2010)	Passed
Radiated immunity	EN-IEC 61000-4-3 (2006) + A1 (2008) + A2 (2010)	Passed
Power Frequency Magnetic field	EN-IEC 61000-4-8 (2010)	Passed

Signed for and on behalf of:

Enschede 2019 August, 28

Igor Ilink, System Solutions Director

¹ When pre-mounted on the MTi-6##-DK

8.2 EU Declaration of Conformity MTi-600 rugged

EU Declaration of Conformity

Applicable objects MTi 600-series Rugged:

MTi-610R
MTi-620R
MTi-630R
MTi-680G
MTi-6##R
MTi-6##G
MTi-6##R-SK
MTi-6##G-SK

Manufacturer:

Xsens Technologies B.V.
Pantheon 6a
7521 PR ENSCHEDE
THE NETHERLANDS

This declaration of conformity is issued under the sole responsibility of the manufacturer.

The objects of the declaration described above are in conformity with the relevant Union harmonization legislation, based on the tested mode of operation(s), the applicable performance criteria, and specified acceptance criteria:

Short name	Directive
Electromagnetic compatibility (EMC)	2014/30/EU
Restriction of the use of certain hazardous substances (RoHS)	2011/65/EU

Relevant harmonized standards used:

Standard description	Standard	Result
Emission	EN 61326-1 (2013), class B	Pass
Immunity	EN 61326-1 (2013), Industrial	Pass
Radiated emission up to 1 GHz (SAC)	EN 55011 (2009) + A1 (2010)	Pass
Radiated immunity	EN-IEC 61000-4-3 (2006) + A1 (2008) + A2 (2010)	Pass
Power Frequency Magnetic field	EN-IEC 61000-4-8 (2010)	Pass

The following test report is subject to this declaration:

Test report number: 20200302RPT01.pdf Issue date: 2020 June, 18

Signed for and on behalf of:

Enschede 2020 July, 01

Igor Ilink, Director Technology

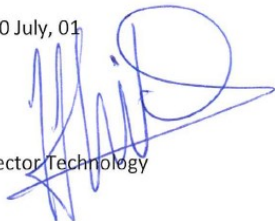

8.3 FCC Declaration of Conformity MTi-600 module

FCC Declaration of Conformity

Applicable objects:

MTi-610¹
MTi-620¹
MTi-630¹
MTi-670¹
MTi-6##-DK

Manufacturer:
Xsens Technologies B.V.
Pantheon 6a
7521 PR ENSCHEDE
THE NETHERLANDS

The objects of the declaration described above is in conformity with the relevant FCC regulations, based on the tested mode of operation(s), the applicable performance criteria, and specified acceptance criteria

Object classification	Directive
Computers and other digital devices, unintentional radiator	47 CFR 15

Relevant standards used:

Test description	Standard	Result
Emission	47 CFR 15 & ICES-003 (Issue 6), class B	Passed
Radiated emission up to 1 GHz (SAC)	ANSI C63.4 (2014)	Passed
Radiated emission above 1 GHz (FAC)	ANSI C63.4 (2014)	Passed

Operation is subject to the following two conditions:

- (1) this device may not cause harmful interference, and
- (2) this device must accept any interference received, including interference that may cause undesired operation.

The following test report is subject to this declaration:

Test report number: 19C00379RPT03.pdf
Issue date: 2019 August, 28

The following manufacturer/importer/entity is responsible for this declaration:

Company name: Xsens Technologies B.V.
Name Title: Igor Ikin, System Solutions Director
Address: Pantheon 6a, 7521 PR ENSCHEDE, THE NETHERLANDS
Phone: +31 (0)889736700
Fax: +31 (0)889736701

¹ When pre-mounted on the MTi-6##-DK



8.4 FCC Declaration of Conformity MTi-600 rugged

FCC Declaration of Conformity

Applicable objects:

MTi-610R
MTi-620R
MTi-630R
MTi-680G
MTi-6##R
MTi-6##G
MTi-6##R-SK
MTi-6##G-SK

Manufacturer:

Xsens Technologies B.V.
Pantheon 6a
7521 PR ENSCHEDE
THE NETHERLANDS

The objects of the declaration described above is in conformity with the relevant FCC regulations, based on the tested mode of operation(s), the applicable performance criteria, and specified acceptance criteria

Object classification	Directive
Computers and other digital devices, unintentional radiator	47 CFR 15

Relevant standards used:

Test description	Standard	Result
Emission	47 CFR 15 & ICES-003, class B	Pass
Radiated emission up to 1 GHz (SAC)	ANSI C63.4 (2014)	Pass
Radiated emission above 1 GHz (FAC)	ANSI C63.4 (2014)	Pass

Operation is subject to the following two conditions:

- (1) this device may not cause harmful interference, and
- (2) this device must accept any interference received, including interference that may cause undesired operation.

The following test report is subject to this declaration:

Test report number: 20200307RPT0.1.pdf Issue date: 2020 June, 18

The following manufacturer/importer/entity is responsible for this declaration:

Company name: Xsens Technologies B.V.
Name Title: Igor Ikin, Director Technology
Address: Pantheon 6a, 7521 PR ENSCHEDE, THE NETHERLANDS
Phone: +31 (0)889736700
Fax: +31 (0)889736701

Signed for and on behalf of:

Enschede 2020 July, 01

Igor Ikin, Director Technology