

Triple-Balanced Mixer

Rev. V3

Features

- LO 2 TO 18 GHz
- RF 2 TO 18 GHz
- IF 2 TO 8 GHz
- LO DRIVE +21 dBm (nominal)
- WIDE BANDWIDTH
- HIGH THIRD-ORDER I.P. +24 dBm (TYP.)

Description

MY88H is a triple balanced mixer, designed for use in military, commercial and test equipment applications. The design utilizes Schottky ring quad diodes and broadband soft dielectric baluns to attain excellent performance. The use of high temperature solder assembly processes used internally makes it ideal for use in manual, semi-automated assembly. Environmental screening available to MIL-STD-883, MIL-STD-202 or MIL-DTL-28837, consult factory.

Ordering Information

Part Number	Package
MY88H	Versapac
MY88HC	SMA Connectorized

Product Image

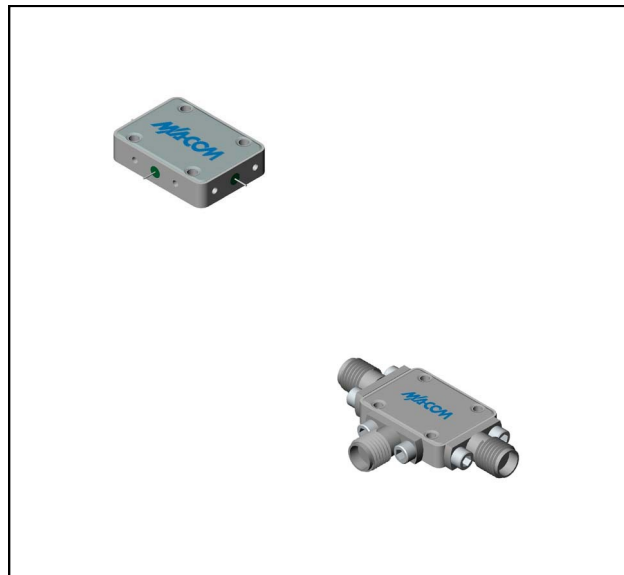

Electrical Specifications: $Z_0 = 50\Omega$ $Lo = +21$ dBm (Downconverter Application only)

Parameter	Test Conditions	Units	Typical	Guaranteed	
				+25°C	-54° to +85°C
SSB Conversion Loss (max) & SSB Noise Figure (max)	fR = 2 to 10 GHz, fL = 2 to 18 GHz, fI = 2 to 8 GHz fR = 10 to 18 GHz, fL = 2 to 18 GHz, fI = 2 to 8 GHz	dB dB	7.5	10.0	10.3
			8.0	10.5	10.8
Isolation, L to R (min)	fL = 2 to 18 GHz	dB	28	15	14
Isolation, L to I (min)	fL = 2 to 18 GHz	dB	32	17	16
1 dB Conversion Comp.	fL = +24 dBm	dBm	+17		
Input IP3	fR1 = 6 GHz at 0 dBm, fR2 = 6.01 GHz at 0 dBm, fL = 8 GHz at +21 dBm fR1 = 14 GHz at 0 dBm, fR2 = 14.01 GHz at 0 dBm, fL = 10 GHz at +21 dBm	dBm dBm	+26		
			+24		

Typical Performance Curves

Conversion Loss vs Lo Drive Power

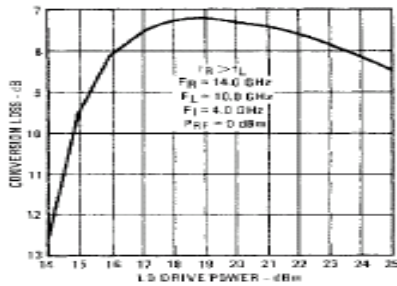

Drive Level: The maximum recommended drive level is +24 dBm.

Conversion Loss vs Input Frequency
Lo @ +21 dBm

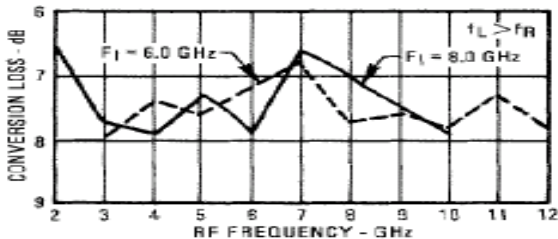
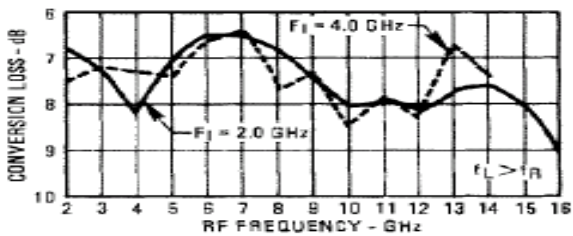
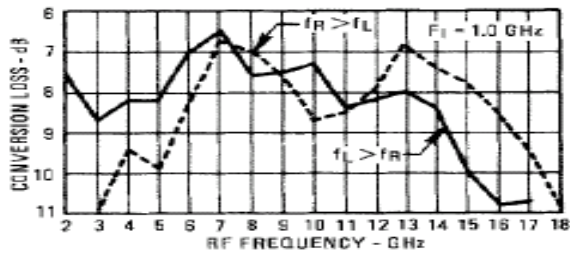

R-Port VSWR Lo @ +21 dBm

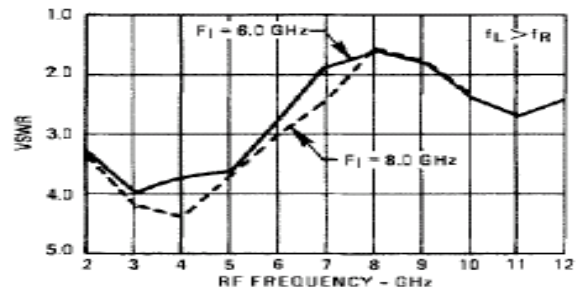
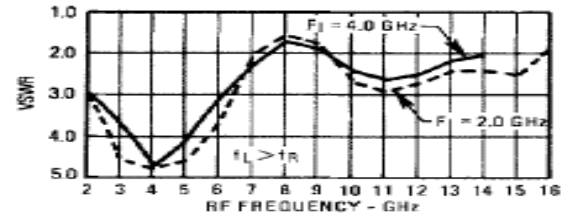
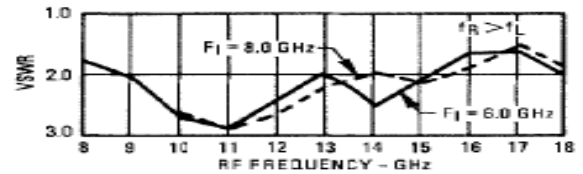
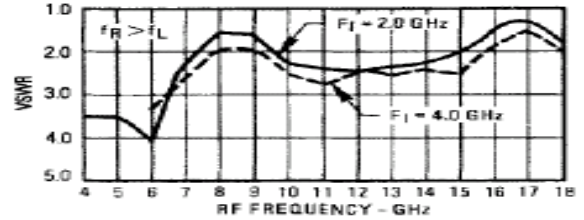

Triple-Balanced Mixer

Rev. V3

Absolute Maximum Ratings

Parameter	Absolute Maximum
Operating Temperature	-54°C to +100°C
Storage Temperature	-65°C to +100°C
Peak Input Power	+27 dBm max @ +25°C +24 dBm max @ +100°C
Peak Input Current	100 mA DC

Outline Drawing: Versapac *

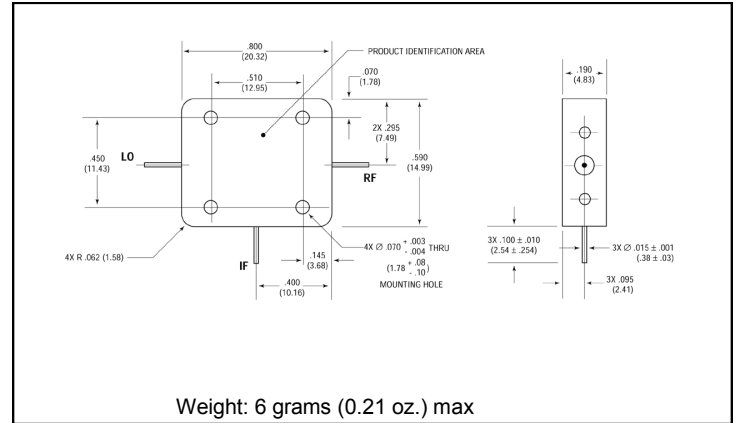

Outline Drawing: SMA Connectorized *

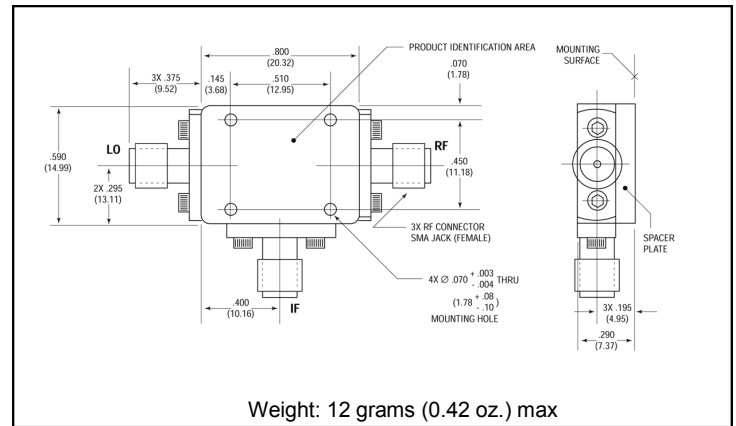

Isolation vs Frequency

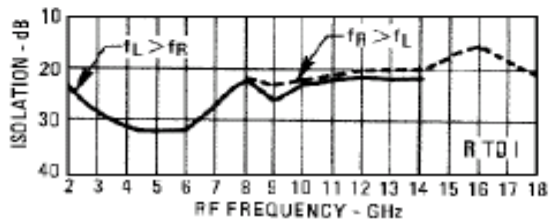
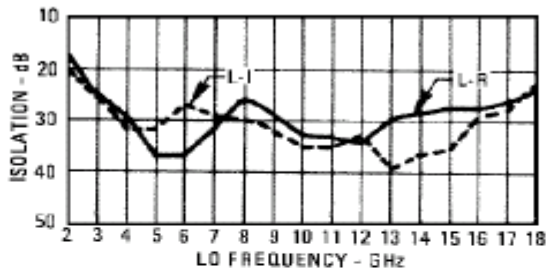

L-Port VSWR @ +21 dBm

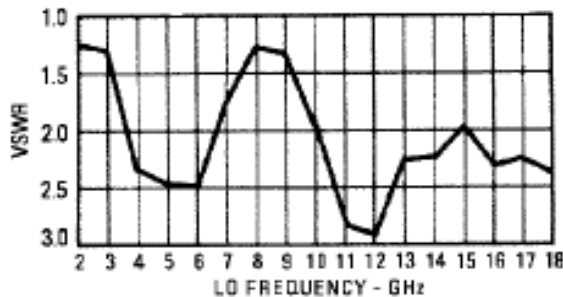

* Dimensions are inches (millimeters) ±0.015 (0.38) unless otherwise specified.