

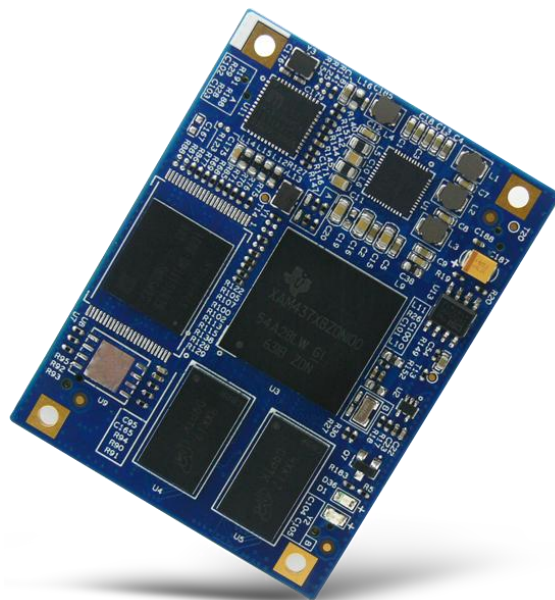

MYC-C437X CPU Module Overview



- ✓ Up to 1GHz TI AM437x Series ARM Cortex-A9 Processors
- ✓ 512MB DDR3 SDRAM, 4GB eMMC Flash, 32KB EEPROM
- ✓ Gigabit Ethernet PHY
- ✓ Power Management IC
- ✓ Two 0.8mm pitch 100-pin Board-to-Board Expansion Connectors
- ✓ Provided with Linux and SYS/BIOS (TI-RTOS) Software Packages



The MYC-C437X CPU Module is a low-cost compact-sized SOM (System on Module) based on 1GHz Sitara AM437x (AM4376, AM4377, AM4378, AM4379) ARM Cortex-A9 processors from Texas Instruments (TI), featuring 3D graphics acceleration for rich graphical user interfaces, PRU-ICSS for industrial protocols, improved Vector Floating Point (VFP) unit and other peripherals and interfaces support like Quad-SPI, dual parallel cameras, two independent eight-channel ADCs, etc.

The MYC-C437X CPU Module integrates the AM437x processor, 512MB DDR3 SDRAM, 4GB eMMC Flash, 32KB EEPROM, Gigabit Ethernet PHY and Power Management IC TPS65218 on board and can be served as the controller board of your next design. It has two 0.8mm pitch 2*50-pin board-to-board expansion connectors for interconnecting with your base board, thus providing an interface for the base board to carry most of the I/O signals to and from the CPU module.

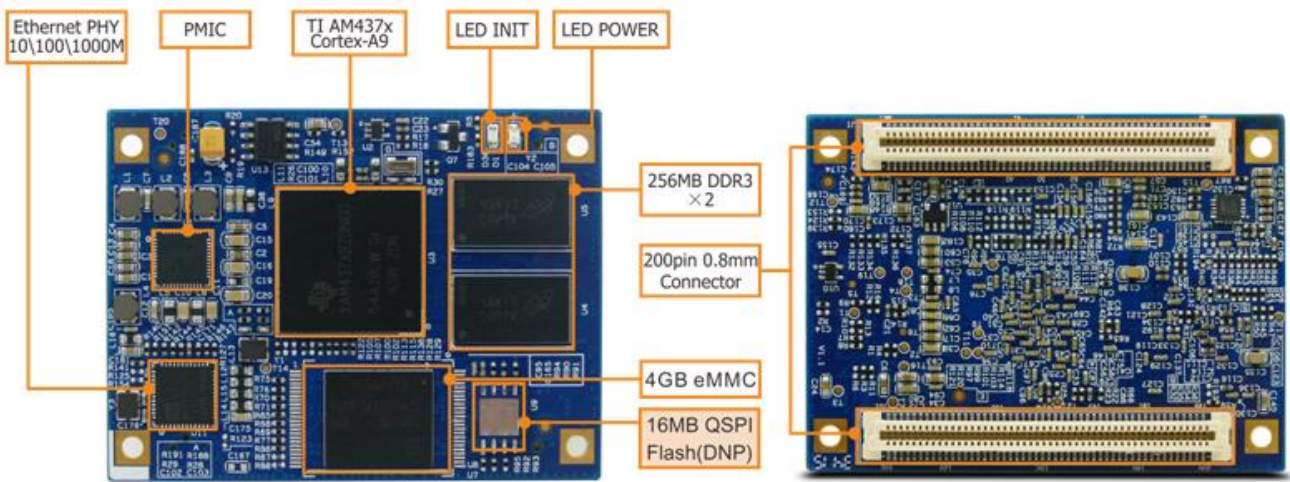

MYC-C437X CPU Module

The MYC-AM437X CPU Module series have four models with different AM437x processors. They are sharing the same pin-out with software fully compatible. MYIR delivers the MYC-C4378 by default. Other three models are only available for mass quantity demand.

You can get to know the main differences of the four AM437x Sitara ARM Cortex-A9 processors from below image.

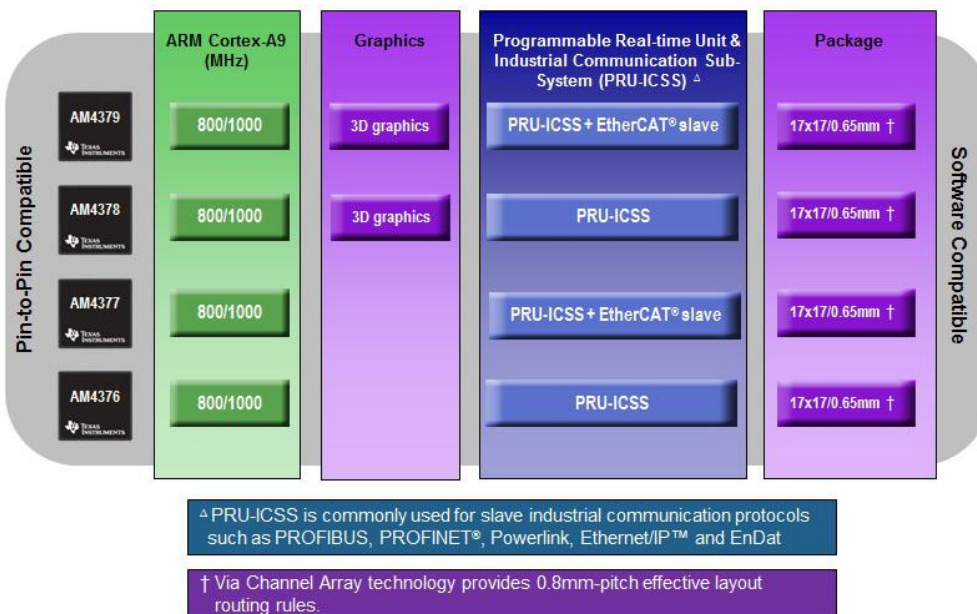

AM437x Devices Comparison



MYIR has also designed two development boards for evaluating the MYC-C437X CPU Module. The two boards are all built around the MYC-C437X CPU Module but the base board designs are different to satisfy customers' different requirements. The MYD-C4378 development board features versatile peripheral interfaces extended on base board including four USB Host ports, one USB OTG, two Gigabit Ethernet ports, two CAN, two camera interfaces, TF card slot, HDMI and LCD interfaces but it could not support PRU-ICSS. The MYD-C4377-PRU development board is designed especially for PRU-ICSS applications, it features one Gigabit Ethernet port as well as two 10/100Mbps Ethernet ports from the PRU-ICSS subsystems and uses TI SYS/BIOS v6.45 Real-time Operating System. Besides, both of the two boards can run Linux OS and are provided with software packages and detailed documentation sources. They are excellent platforms for customers' evaluation and prototype based on TI AM437x solution.

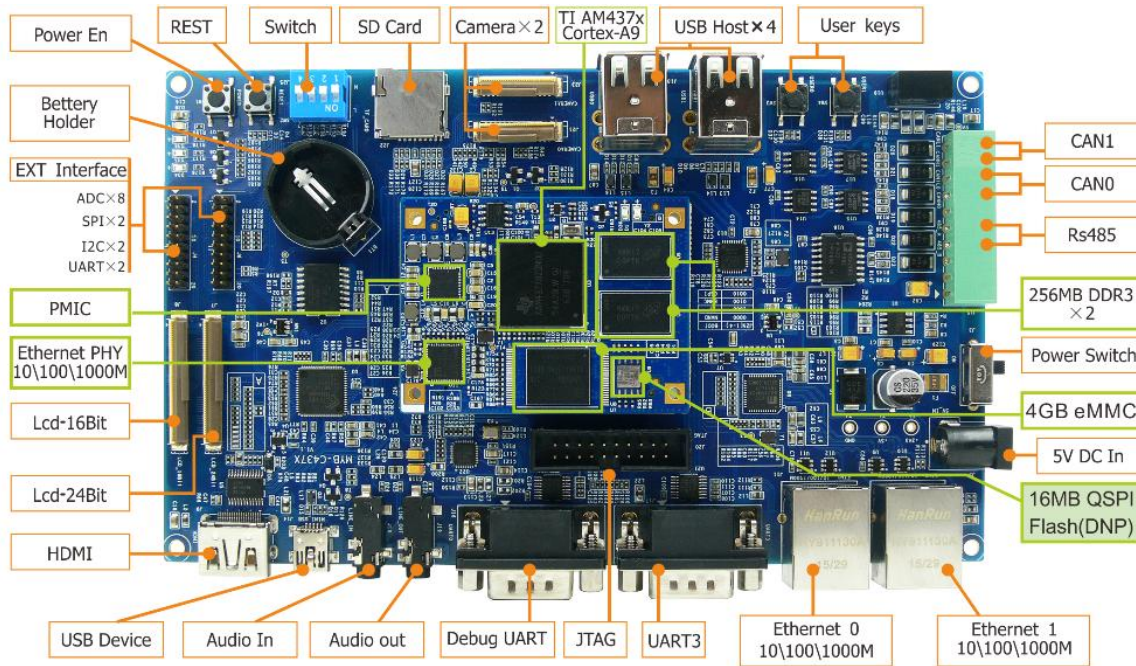

MYD-C437X Development Board

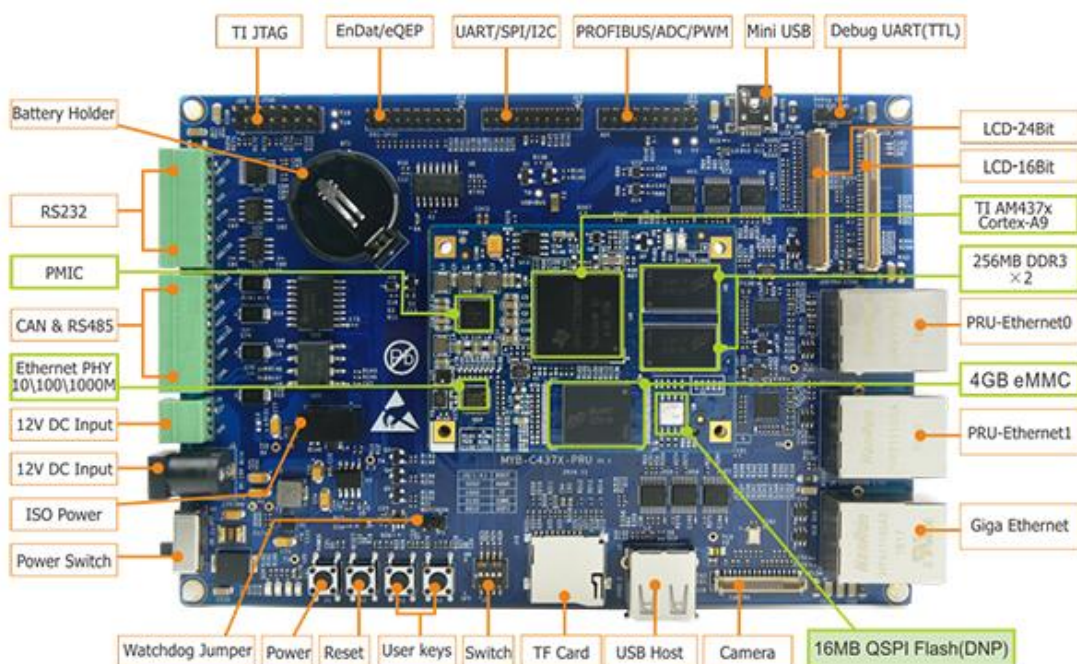

MYD-C437X-PRU Development Board



Hardware Specification

The TI AM437x high-performance processors are based on the ARM Cortex-A9 core. Customers using this next generation solution will see an increase in performance, as well as extensive reuse from the ARM Cortex-A8 offerings.

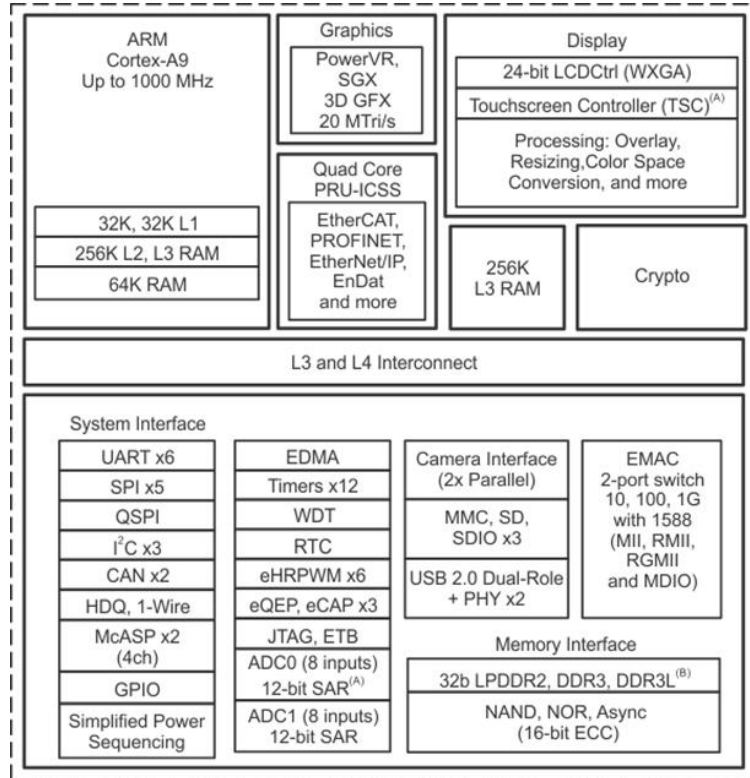

A. Use of TSC will limit available ADC0 inputs.

B. Max clock: LPDDR2 = 266 MHz; DDR3/DDR3L = 400 MHz

AM437x Function Block Diagram

Increasing performance and peripheral support

Sitara AM437x processors deliver the right balance of:

Performance

- Up to 1GHz of processing power
- 3D graphics accelerator
- On-chip quad-core PRU co-processor for real-time processing
- Improved vector floating-point unit

Interfaces

- LPDDR2/DDR3
- QSPI
- Display subsystem

Connectivity

- Two parallel camera ports
- Dual-port 1Gb Ethernet switch
- Two independent, eight-channel ADCs
- WiLink connectivity drivers
- Industrial protocols via PRU-ICSS



Mechanical Parameters

- Dimensions: 60mm x 45mm
- PCB Layers: 8-layer design
- Power supply: +5V/2A
- Static power: about 5V/0.33A
- Working temperature: 0~70 Celsius (commercial grade) or -40~85 Celsius (industrial grade)

Processor

- TI AM437x (AM4376, AM4377, AM4378, AM4379)
 - Up to 1GHz Sitara ARM Cortex-A9 32-Bit RISC processor
 - POWERVR SGX Graphics Accelerator subsystem for 3D graphics acceleration to support display and gaming effects
 - Single-cycle vector floating point (VFP)
 - Dual camera and display processing subsystem
 - Cryptographic acceleration and secure boot
 - PRU-ICSS enables simultaneous industrial Ethernet protocols and motor feedback protocols
 - Support for 32 bit LPDDR2/DDR3/DDR3L
 - Low power: ~5mW deep sleep and < 0.1mW RTC-only
 - Simplified power sequence for flexible power designs

Memory

- 256MB DDR3 SDRAM (512MB is optional)
- 4GB eMMC Flash (reserved 256/512MB Nand Flash design)
- 16MB QSPI Flash (reserved design, not soldered on board)
- 32KB EEPROM

Peripherals and Signals Routed to Pins

- Power Management IC (TPS65218B1RSLR)
- Gigabit Ethernet PHY (V1 uses AR8035, V2 uses YT8511)
- One power indicator (Red LED)
- One user LED (Green)
- Two 0.8mm pitch 100-pin board-to-board expansion connectors can carry out interfaces below
 - 2 x USB
 - 6 x Serial ports
 - 2 x I2C
 - 2 x CAN
 - 2 x SPI
 - 14 x ADC (8 channels from ADC1 and 6 channels from ADC0)
 - 3 x SDIO



Function Block Diagram

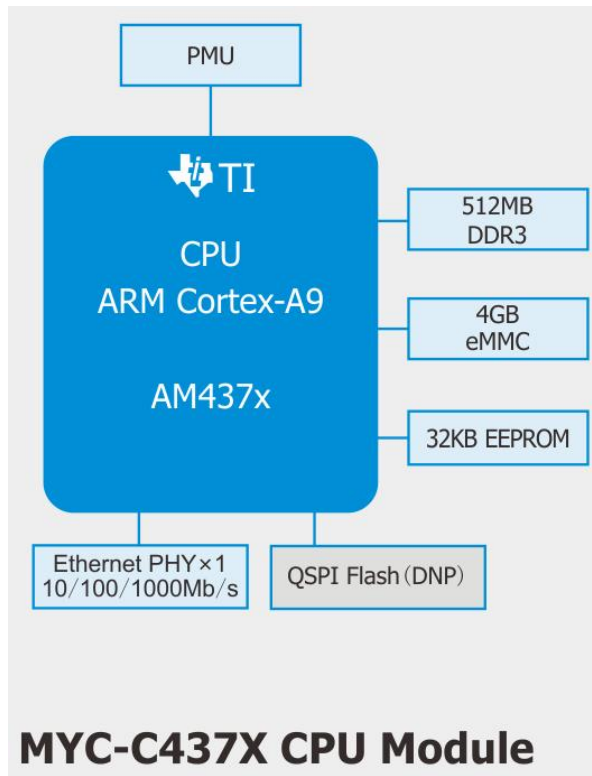

MYC-C437X Function Block Diagram

Dimension Chart of MYC-C437X

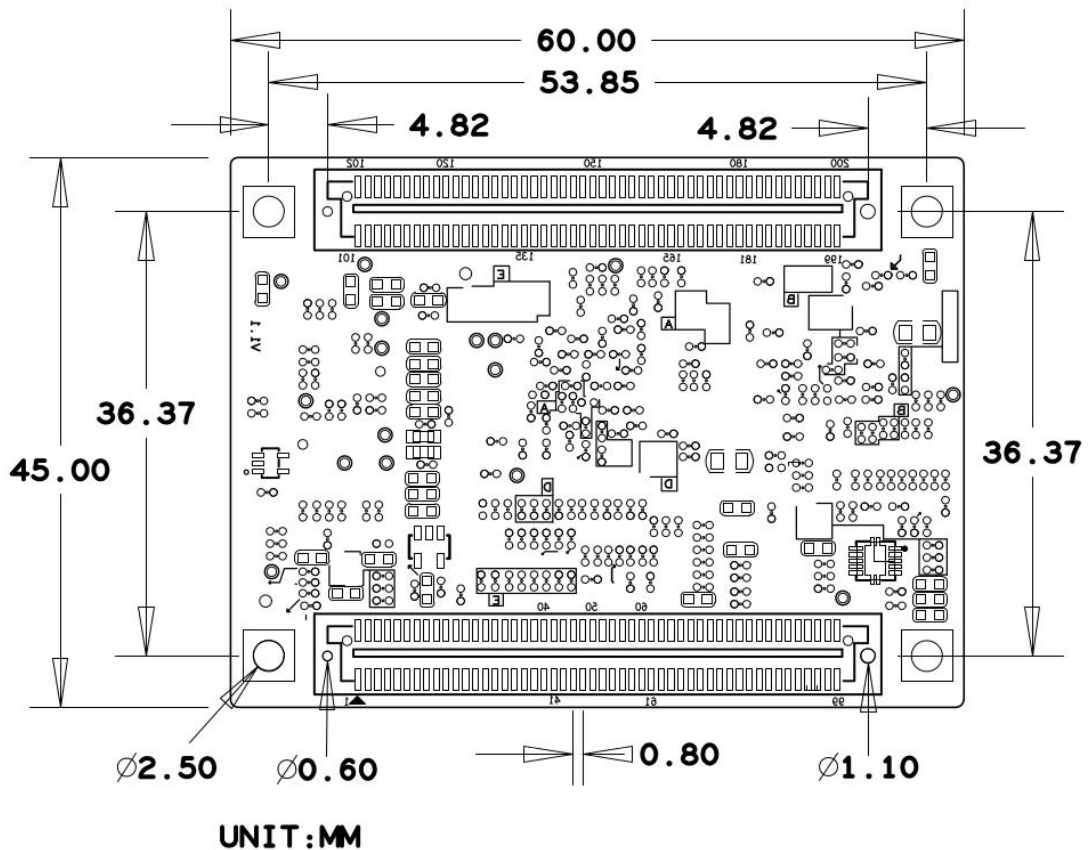

MYC-C437X Dimension Chart



Software Features

OS	Item	Features	Description	
Linux	Bootstrap program	u-boot-201605	Bootstrap (source code)	
	Kernel	Version	Linux 4.1.18 (Customized kernel for MYD-C437X, source code) Linux 4.1.18 (especially designed for MYD-C437X-PRU, source code)	
	Drivers	USB Host		USB Host driver (source code)
		USB OTG		USB OTG driver (source code)
		Ethernet		Gigabit Ethernet driver (source code)
		PRU Ethernet		Industrial Ethernet driver (source code)
		MMC/SD/TF		MMC/SD/TF card driver (source code)
		Nand Flash		Nand Flash driver (source code)
		eMMC		eMMC driver (source code)
		CAN		CAN driver (source code)
		RS485		RS485 driver (source code)
		LCD Controller		LCD driver (source code, supports 4.3, 7-inch LCD)
		RTC		RTC driver (source code)
		Touch driver		Resistive and Capacitive touch screen driver (source code)
		Button		Button driver (source code)
		UART		UART driver (source code)
		LED		LED driver (source code)
		Watchdog		Watchdog driver (source code)
		Camera		Camera driver (source code)
		ADC		ADC driver (source code)
	SPI		SPI driver (source code)	
I2C		I2C driver (source code)		
File system	Buildroot		Provide image file	
	Arago		Provide image file	
SYS/BIOS	Kernel	Version	SYS/BIOS 6.45 for MYD-C437X-PRU	
	Evaluation environment		Code Composer Studio Version 6.2.x	
	ARM compiler		GNU V4.9.3 (Linaro)	
	PRU compiler		PRU 2.1.13	
	Application Examples		Bootloader, EtherCAT Slave Application, EtherNet/IP Adapter Application, EtherNet MAC Application, Example Utils Application	

Software Features of MYC-C437X