

MYC-C8MMX-V2 CPU Module

- NXP i.MX 8M Mini Quad Application Processor based on 1.8 GHz Arm Cortex-A53 and 400MHz Cortex-M4 Cores
- 2GB DDR4, 8GB eMMC Flash, 32MB QSPI Flash
- On-board Gigabit Ethernet PHY
- ROHM Power Management IC (PMIC)
- Two 0.8mm pitch 100-pin Board-to-Board Expansion Connectors
- Supports Working Temperature Ranging from -40°C to 85°C
- Supports Running Yocto Linux, Ubuntu Linux, Android

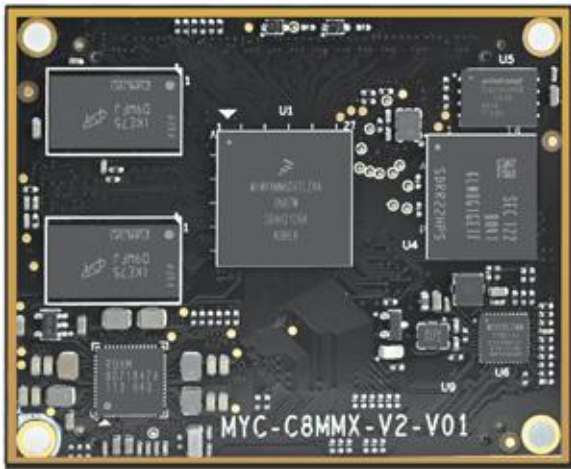

Figure 1-1 MYC-C8MMX-V2 CPU Module Top-View

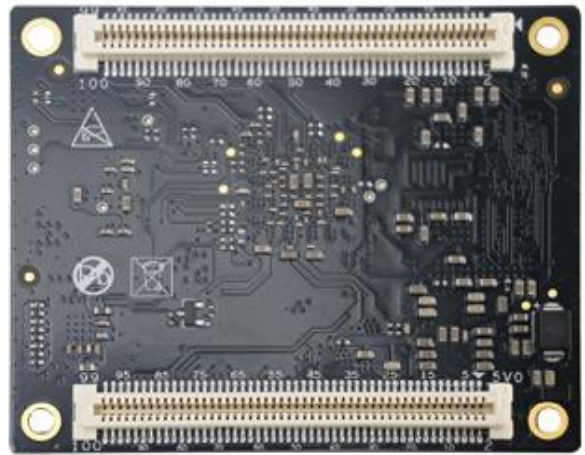

Figure 1-2 MYC-C8MMX-V2 CPU Module Bottom-View

Measuring 60mm by 49mm, the [MYC-C8MMX-V2 CPU Module](#) is a low-cost embedded ARM SoM based on NXP's first embedded multi-core applications processor [i.MX 8M Mini](#) which features up to 1.8GHz quad-core Cortex-A53 plus 400MHz Cortex-M4 processor, combining advanced 14LPC FinFET process technology to provide more speed and improved power efficiency. It has 2GB DDR4, 8GB eMMC and 32MB QSPI flash default memory and storage configuration as well as integrated GigE PHY and PMIC. A number of peripheral and IO signals are access through two 0.8mm pitch 100-pin board-to-board expansion connectors. It is capable of running Linux and Android OS and provided with plenty of software resources.

MYIR offers [MYD-C8MMX-V2 development board](#) for evaluating the [MYC-C8MMX-V2 CPU Module](#), the base board has taken great media capabilities of the i.MX 8M Mini processor to provide MIPI-DSI, MIPI-CSI, LVDS interfaces and Audio In/Out ports. It also has strong communication connectivity with 2 x USB 2.0 Host ports and 1 x Micro USB 2.0 Host/Device port, Gigabit Ethernet, MicroSD card slot, USB based Mini PCIe interface for 4G LTE Module, WiFi/Bluetooth and NVMe PCIe M.2 2280 SSD Interface. MYIR can offer design services to help customize the base board according to customers' requirements.

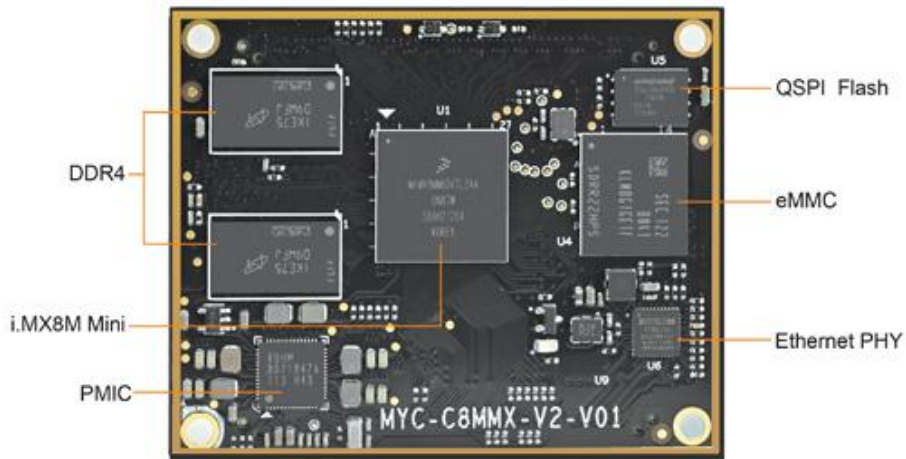

Figure 1-3 MYC-C8MMX-V2 CPU Module

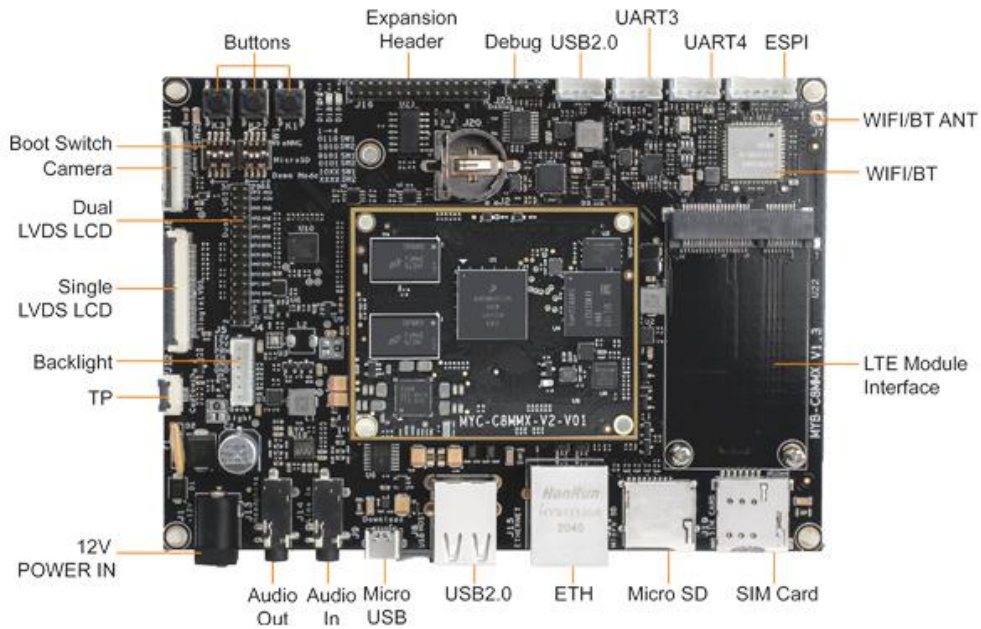

Figure 1-4 MYD-C8MMX-V2 Development Board Top-view

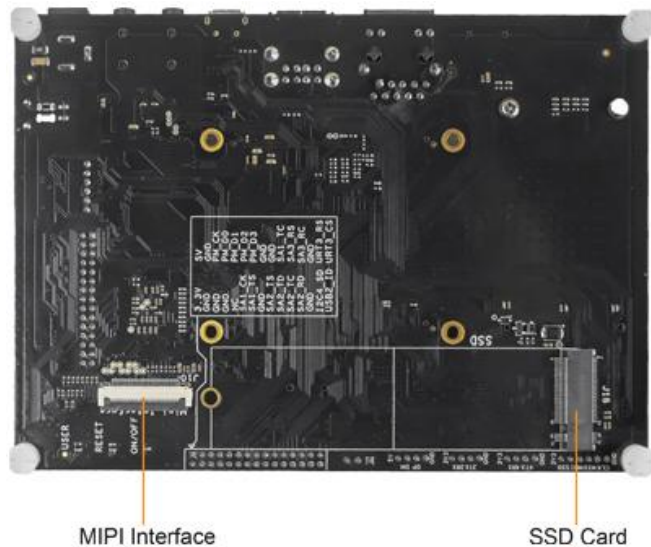

Figure 1-4 MYD-C8MMX-V2 Development Board Bottom-view

Hardware Specification

The MYC-C8MMX-V2 CPU Module is using NXP's 14 x 14 mm, 0.5 mm pitch, FCBGA486 package i.MX 8M Mini Quad Application Processor (MIMX8MM6DVTLZAA/MIMX8MM6CVTKZAA) which is among the [i.MX 8M Mini family](#) and features as in below table.

Feature	MIMX8MM6CVTKZAA	MIMX8MM6DVTLZAA
Marketing Description	<i>i.MX 8M Mini Quad</i>	<i>i.MX 8M Mini Quad</i>
Core: Number of cores (SPEC)	4	4
Core Type	<i>Arm Cortex-A53</i>	<i>Arm Cortex-A53</i>
Operating Frequency [Max] (MHz)	1600	1800
Co Processor Type	<i>Arm Cortex-M4F</i>	<i>Arm Cortex-M4F</i>
Co Processor Frequency (MAX) (MHz)	400	400
External Memory Supported	<i>DDR3L SDRAM, DDR4 SDRAM, ECC, LPDDR4 DRAM, NAND FLASH, NOR FLASH, QSPI</i>	
L2 Cache (Max) (KB)	512	
Ethernet Type	1 Gbps + IEEE 1588 + AVB	
Serial Communication	3 x SPI, 4 x I ² C, 4 x UART	
PCIe 2.0	1	
USB Controllers	2	
Video Decode Acceleration	<i>HD1080p60, H.265, H.264, VP8, VP9</i>	
Video Encode Acceleration	<i>HD1080p60, H.264, VP8</i>	
Display	1 x MIPI-DSI	
Camera	1 x MIPI-CSI	
GPU 2D / GPU 3D	<i>1x shader, Vivante GC320, Vivante GCNanoUltra</i>	
Audio Specific Modules	<i>8-ch PDM input, SAI/I2S</i>	
Junction Temperature (Min) (°C)	-40	0
Junction Temperature (Max) (°C)	105	95

Table 1-1 Features of i.MX 8M Mini Quad Application Processor

The [i.MX 8M Mini family](#) of applications processors (i.MX 8M Mini Quad/QuadLite, i.MX 8M Mini Dual/DualLite, i.MX8M Mini Solo/SoloLite) represent NXP’s latest video and audio experience combining state-of-the-art media-specific features with high-performance processing while optimized for lowest power consumption. The i.MX 8M Mini family of processors features advanced implementation of a quad Arm® Cortex®-A53 core, which operates at speeds of up to 1.8GHz. A general-purpose Cortex®-M4 400 MHz core processor is for low-power processing. The DRAM controller supports 32-bit/16-bit LPDDR4, DDR4, and DDR3L memory. A wide range of audio interfaces are available, including I2S, AC97, TDM, and S/PDIF. There are a number of other interfaces for connecting peripherals, such as USB, PCIe, and Ethernet. It is NXP’s first embedded multicore applications processor built using advanced 14LPC FinFET process technology, providing more speed and improved power efficiency. With commercial and industrial level qualification and backed by NXP’s product longevity program, the i.MX 8M Mini family may be used in any general purpose industrial and IoT application.

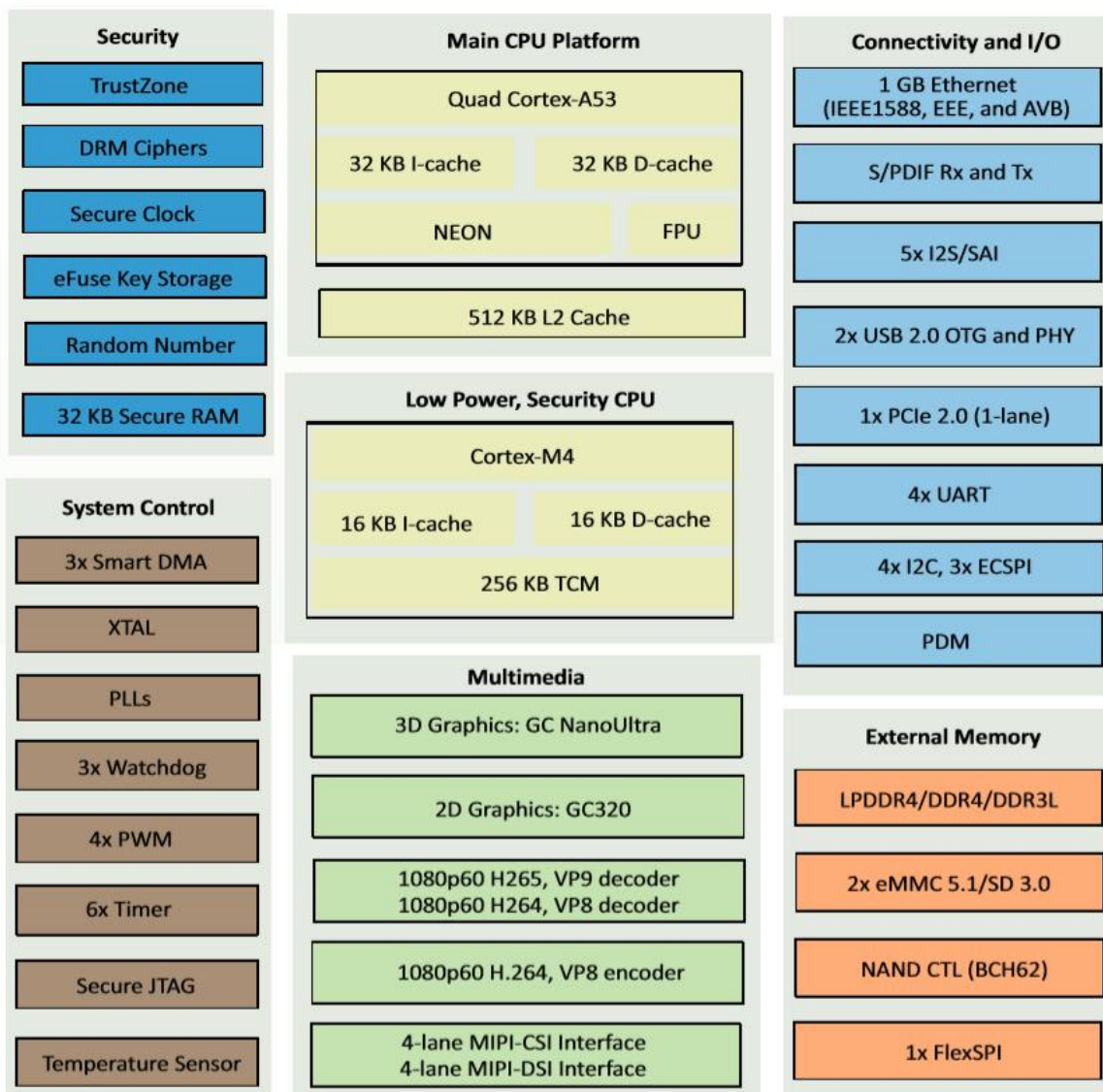

Figure 1-5 i.MX 8M Mini System Block Diagram

Mechanical Parameters

- Dimensions: 60mm x 49mm
- PCB Layers: 8-layer design
- Power supply: +5V/0.23A
- Working temperature: 0~70 Celsius (commercial grade) or 40~85 Celsius (industrial grade)

Processor

- NXP i.MX 8M Mini Processor
- - 1.8 GHz Quad-core ARM Cortex-A53 CPU (MIMX8MM6DVTZAA, commercial grade) /
- 1.6 GHz Quad-core ARM Cortex-A53 CPU (MIMX8MM6CVTKZAA, industrial grade)
- - 400MHz Real-time ARM Cortex-M4 co-processor
- - Integrated 2D/3D GPU and 1080p VPU

Memory

- 2GB DDR4 (supports up to 4GB DDR4)
- 8GB eMMC Flash (supports up to 64GB eMMC)
- 32MB QSPI Flash

Peripherals and Signals Routed to Pins

[MYC-C8MMX-V2 Pinouts Description](#)

- One 10/100/1000M Ethernet PHY (YT8511)
- Power Management IC (ROHM BD71847MWV)
- Two 0.8mm pitch 100-pin Board-to-Board Expansion Connectors
- - 1 x 10/100/1000Mbps Ethernet
- - 3 x Serial ports
- - 3 x I2C
- - 3 x SPI
- - 4 x PWM
- - 2 x USB 2.0
- - 1 x PCIe
- - 5 x I2S / SAI
- - 1 x MIPI-CSI
- - 1 x MIPI-DSI
- - Up to 103 GPIOs

Note: the peripheral signals brought out to the expansion interface are listed in maximum number. Some signals are reused. Please refer to the processor data sheet.

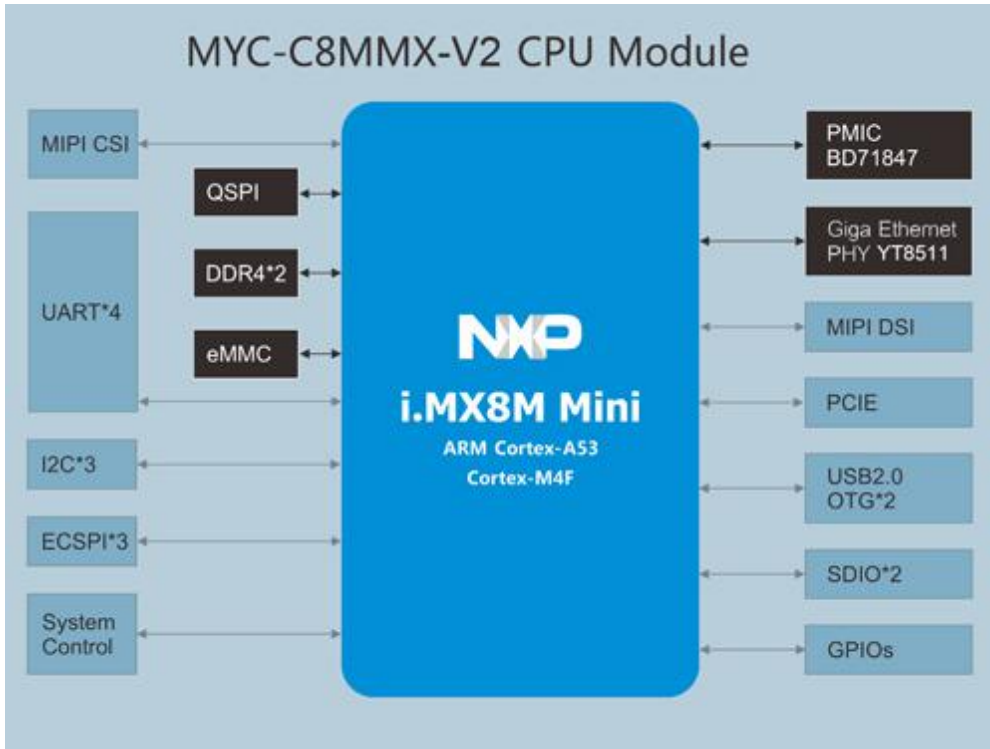

Figure 1-6 MYC-C8MMX-V2 CPU Module Function Block Diagram

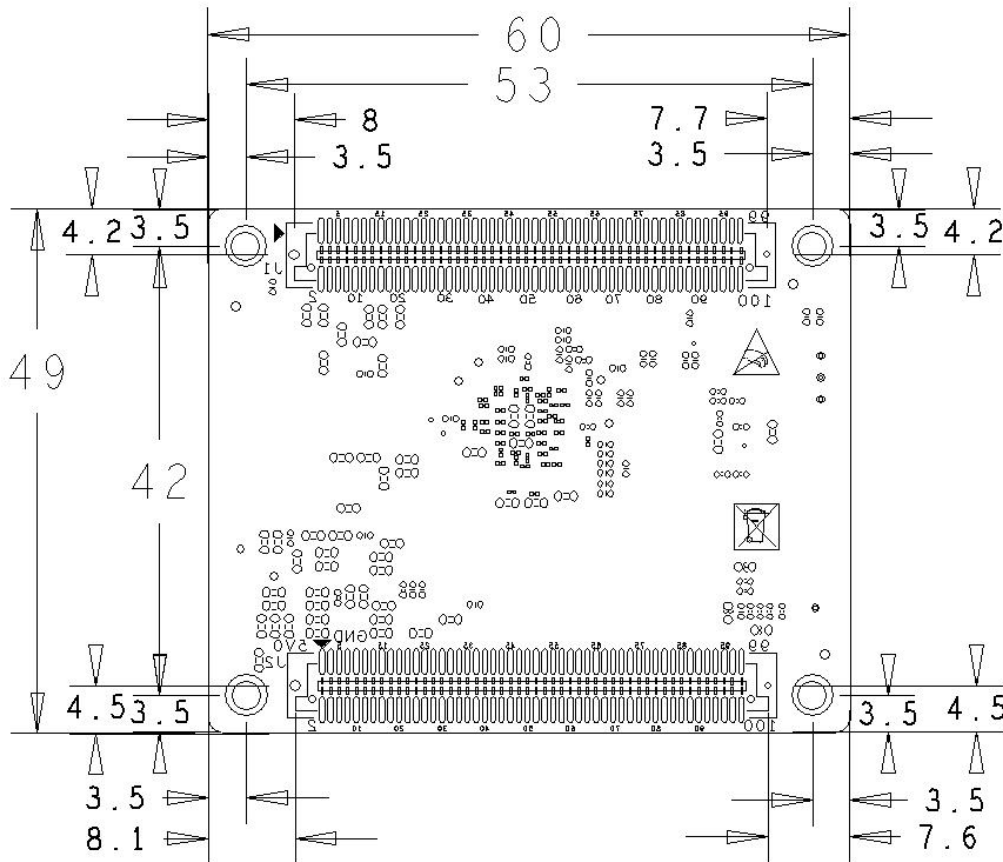

Figure 1-7 MYC-C8MMX-V2 Dimensions Chart

Software Features

MYIR's MYC-C8MMX-V2 CPU module is ready to run Linux, Android OS and is provided with software packages. Many peripheral drivers are in source code to help accelerate customers' designs. The software package provided is characterized as following:

Item	Features	Description	Source Code Provided
Bootstrap program	U-boot	The primary bootstrap based on U-boot 2019.04	YES
Linux kernel	Image	Based on Linux 5.4.3	YES
Drivers	PMIC	BD71847MWV PMIC driver	YES
	USB Host	USB Host driver	YES
	USB OTG	USB OTG driver	YES
	I2C	I2C Bus driver	YES
	SPI	SPI Bus driver	YES
	Ethernet	10/100/1000M Ethernet driver	YES
	MMC	MMC/eMMC/TF card driver	YES
	LCD	MIPI-LVDS driver	YES
	PWM	PWM driver	YES
	RTC	RTC driver	YES
	IO	GPIO driver	YES
	Touch	Capacitive touch screen driver	YES
	Audio	WM8904 driver	YES
	Camera	Ov5640 driver	YES
	WiFi & BT	AP6212 driver	YES
	Watchdog	Watchdog driver	YES
	4G LTE Module	Supports Quectel's EC20 using USB driver	YES
M.2	NVME driver	YES	
File System	Yocto rootfs	Yocto 3.0, including QT5.13.2	YES
		Common file system for terminal	YES
Application Programs	GPIO KEY	Key example	YES
	GPIO LED	LED example	YES
	NET	TCP/IP Socket C/S example	YES
	RTC	RTC example	YES
	UART	UART example	YES
	Audio	Audio example	YES
	LCD	LCD example	YES
Camera	Camera display example	YES	
Compiler Tool Chain	Cross compiler	Yocto GCC 7.3.0 Hardfloat	BINARY

Table 1-2 Yocto Linux Software Features

Item	Features	Description	Source Code Provided
Bootstrap program	U-boot	The primary bootstrap	YES
Linux kernel	Boot	Based on NXP official android_9.0.0_2.3.0 version	YES
Drivers	PMIC	BD71847MWV PMIC driver	YES
	USB Host	USB Host 2.0 driver	YES
	I2C	I2C Bus driver	YES
	SPI	SPI Bus driver	YES
	Ethernet	10/100/1000M Ethernet driver	YES
	MMC	MMC/eMMC/TF card driver	YES
	LVDS	LVDS driver	YES
	PWM	PWM driver	YES
	RTC	RTC driver	YES
	GPIO	GPIO driver	YES
	Audio	WM8904 driver	YES
	Camera	Ov5640 driver	YES
	WiFi & BT	AP6212 driver	YES
	Watchdog	Watchdog driver	YES
	4G LTE Module	Supports Quectel's EC20 using USB driver	NO
	M.2	NVME driver	YES
File System	Android system	Based on Android 9	YES
Compiler Tool Chain	Cross compiler	Gcc version 4.9 x 20150123 (prerelease) (GCC)	YES

Table 1-3 Android Software Features

Item	Features	Description	Source Code Provided
Bootstrap program	U-boot	The primary bootstrap	YES
Linux kernel	Image	Based on NXP official imx_4.14.98_2.0.0_ga version	YES
Drivers	PMIC	BD71847MWV PMIC driver	YES
	USB Host	USB Host driver	YES
	USB OTG	USB OTG driver	YES
	I2C	I2C Bus driver	YES
	SPI	SPI Bus driver	YES
	Ethernet	10/100/1000M Ethernet driver	YES
	MMC	MMC/eMMC/TF card driver	YES
	LCD	MIPI-LVDS driver	YES
	PWM	PWM driver	YES
	RTC	RTC driver	YES
	IO	GPIO driver	YES
	Touch	Capacitive touch screen driver	YES
	Audio	WM8904 driver	YES
	Camera	Ov5640 driver	YES
	Watchdog	Watchdog driver	YES
	4G LTE Module	Supports Quectel's EC20 using USB driver	YES
	M.2	NVME driver	YES
File System	Ubuntu base	Ubuntu18.04 Rootfs	YES
Compiler Tool Chain	Cross compiler	Yocto GCC 7.3.0 Hardfloat	BINARY

Table 1-4 Ubuntu Linux Software Features