

N type Coaxial Connectors

N Series

■ Features

1. 50 ohms wide varieties standard connectors
2. Screw on locking
3. Applicable cable : RG cable, JIS cable
4. Applicable standard : MIL-C-39012/MIL STD 348-304

■ Functional diagram

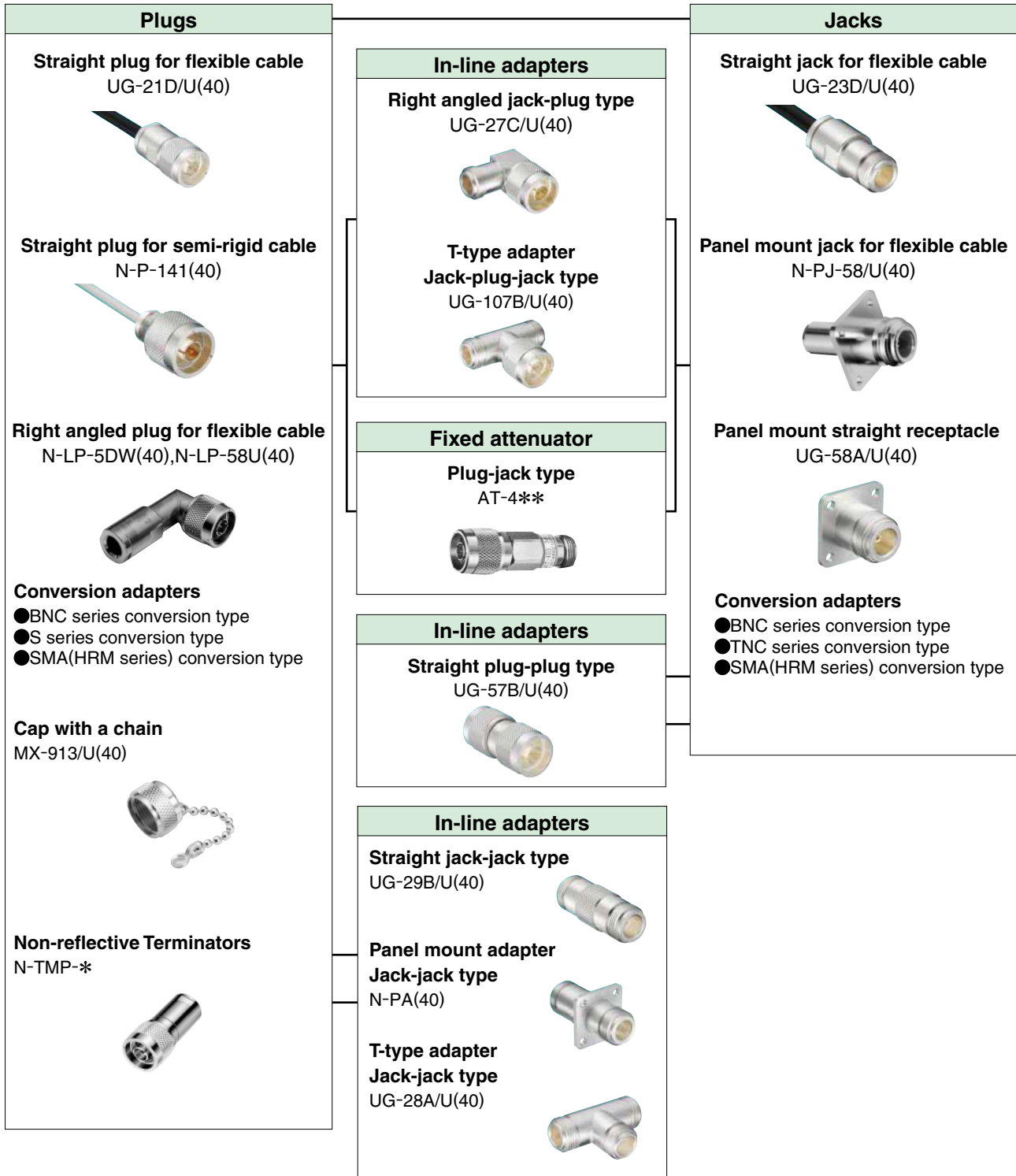

Product Specifications

Ratings	Nominal characteristic impedance Frequency range	50Ω DC to 2GHz	Operating temperature range Operating humidity	-30°C to +60°C 95%RH max.
---------	---	-------------------	---	------------------------------

Item	Specification	Conditions
1. Contact resistance	3mΩ max.	100mA max.
2. Insulation resistance	1000MΩ min.	500V DC
3. Withstanding voltage	No flashover or insulation breakdown.	1500V AC / 1 minute
4. V.S.W.R.*	1.2 max.	Up to 2GHz
5. Durability (mating / un-mating, with corresponding plug)	10mΩ max.	500 cycles
6. Vibration	No electrical discontinuity of 1μs min.	Frequency : 10 to 500Hz, single amplitude of 0.75mm, acceleration of 98m/s ² , for 10 cycles in the direction of each of the 3 axis.
7. Shock	No damage, cracks or parts dislocation.	Acceleration of 490m/s ² , 11ms duration, sine half-wave waveform, 3 cycles in each of 3 axes.
8. Humidity (Steady state)	No damage, cracks or parts dislocation.	96 hours at temperature of 40°C and humidity of 80% to 96%.
9. Temperature cycle	No damage, cracks or parts dislocation.	Temperature : -55°C → +25 to +65°C → +85°C → +5 to +35°C Time : 30min. → 5min. → 30min. → 5min. 5 cycles
10. Salt spray	No excessive corrosion	5% salt water solution, 48 hours

*V.S.W.R. Measurement System

The above V.S.W.R. standard values were measured using the measurement connection as shown below.

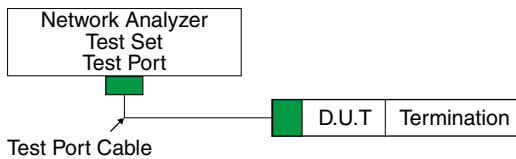

Note 1 : Connectors with cable are measured with 10cm of suitable cable attached at both ends.

Material / Finish

Part	Material	Finish	Remark
Shell	Brass	Silver plated/Nickel plated	——
Male contact	Brass	Silver plated/Gold plated	——
Female contact	Beryllium copper	Silver plated/Gold plated	——
Insulator	Tetrafluoride resin	——	Flame retardant
Packing	Silicone rubber	——	Flame retardant

Product Number Structure

Refer to the chart below when determining the product specifications from the product number.

Please select from the product numbers listed in this catalog when placing orders.

Standard

N - L P - 5DW

① ② ③ ④

① Series name : N	③ Connector type P : Plug J : Jack PJ : Panel jack R : Receptacle A : Adapter PA : Panel adapter
② Connector style Blank : Straight type L : L angle type T : T angle type	④ Applicable cable

Product with MIL standard

UG - 21 D / U

① ② ③ ①

① High frequency coaxial connectors
② Product identification number
③ Improved sign

Straight Plug

Flexible cable type

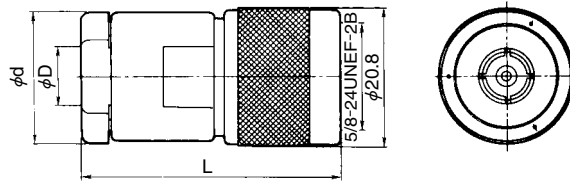

Unit : mm

Part No.	HRS No.	Packaging	Applicable cable	ϕD	ϕd	L
UG-21D/U(40)	301-0003-0 40	1	RG-8/U, RG-9/U	11.1	19.0	38.0
JUG-536/U(40)	301-0001-4 40		RG-58/U	5.4	19.0	38.0
N-P-3DV(40)	301-0078-9 40		3D-2V	6.3	12.7	35.0
N-P-5DV(40)	301-0120-3 40		5D-2V	8.6	18.0	45.5
N-P-5DW(32)	301-0199-3 32		5D-2W	9.3	18.0	46.0
N-P-5DFB(40)	301-0205-4 40		5D-FB	8.6	18.0	46.0
N-P-10DFB(31)	301-0206-7 31		10D-FB	14.5	23.0	55.0

Semi rigid cable type

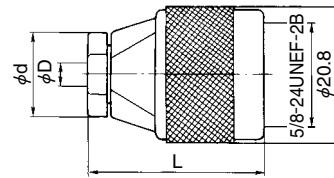

Unit : mm

Part No.	HRS No.	Packaging	Applicable cable	ϕD	ϕd	L
N-P-141(40)	301-0162-3 40	1	UT-141A	3.63	13	27.3
N-P-141-2(A)(40)	301-0262-8 40		UT-141A	3.63	5	25.7
N-P-250(A)(41)	301-0261-5 41		UT-250	6.5	14	34.9

Right angle plug

Flexible cable type

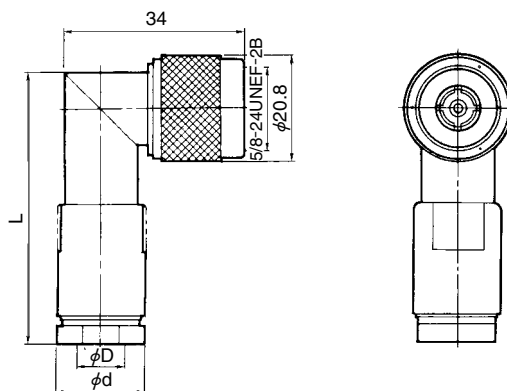

Unit : mm

Part No.	HRS No.	Packaging	Applicable cable	ϕD	ϕd	L	Remarks
N-LP-5DW(40)	301-0007-0 40	1	5D-2W	9.3	17.5	52.4	Nickel-plated except for center conductor
N-LP-58U(40)	301-0076-3 40		RG-58/U	5.3	15.5	44.0	

■Straight jack

●Flexible cable type

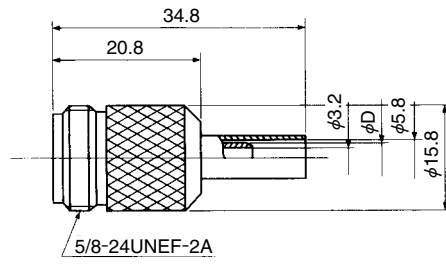

Unit : mm

Part No.	HRS No.	Packaging	Applicable cable	φD
N-J-3DV(40)	301-0180-5 40	1	3D-2V	5.1

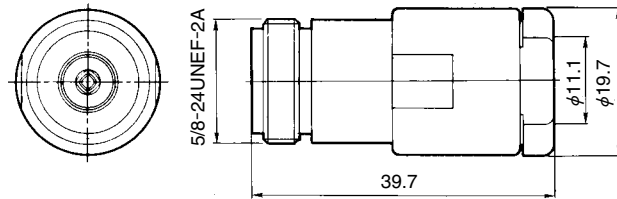

Part No.	HRS No.	Packaging	Applicable cable
UG-23D/U(40)	301-0008-3 40	1	RG-8/U, RG-9/U

■Panel mount jack

●Flexible cable type

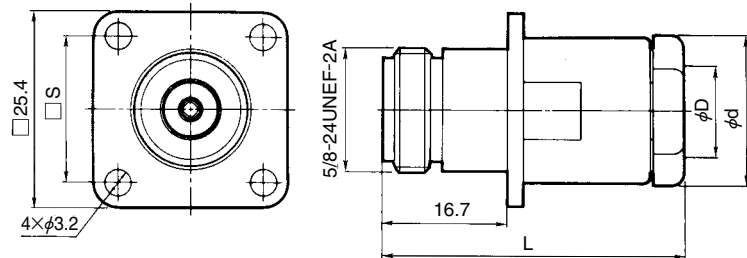

Unit : mm

Part No.	HRS No.	Packaging	Applicable cable	φD	φd	L	□S
UG-22D/U(40)	301-0010-5 40	1	RG-8/U, RG-9/U	11.1	19.0	39.7	18.24
N-PJ-58/U(40)	301-0011-8 40		RG-58/U	5.4	14.6	41.5	18.2

■Receptacle

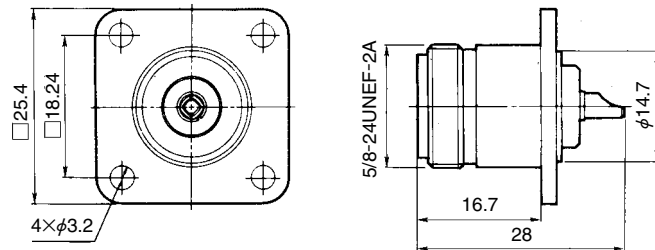

Part No.	HRS No.	Packaging
UG-58A/U(45)	301-0012-0 45	1

■ Straight plug(waterproof type)

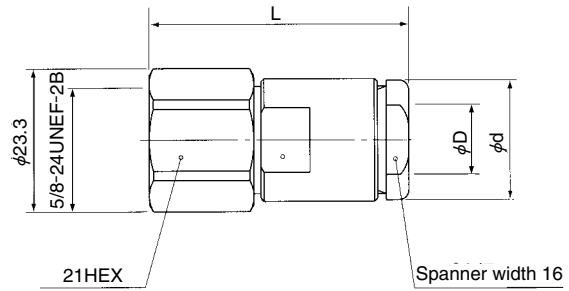

Unit : mm

Part No.	HRS No.	Packaging	Applicable cable	φD	φd	L
N-P-5DFXL(41)	301-0235-5 41	1	5D-FXL	8.6	18	47.2
N-P-8DGXC(40)	301-0228-0 40		8D-GXC	11.6	19.5	49.9

* IP67 compliant

■ Straight jack(waterproof type)

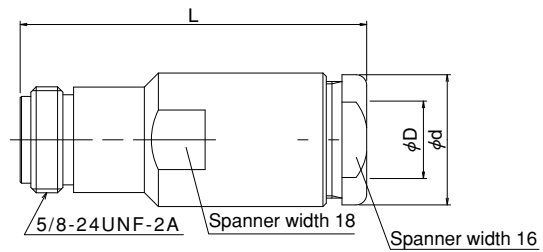

Unit : mm

Part No.	HRS No.	Packaging	Applicable cable	φD	φd	L
N-J-5DFXL(40)	301-0237-0 40	1	5D-FXL	8.6	18	49.1
N-J-8DGXC(40)	301-0229-2 40		8D-GXC	11.6	19.5	51.9

* IP67 compliant

Adapter

●Straight adapter (jack-jack type)

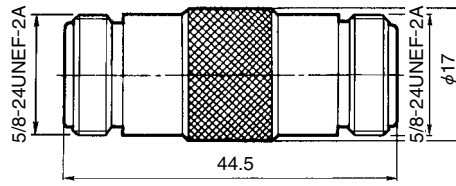

Part No.	HRS No.	Packaging
UG-29B/U(45)	301-0035-6 45	1

(Plug-plug type)

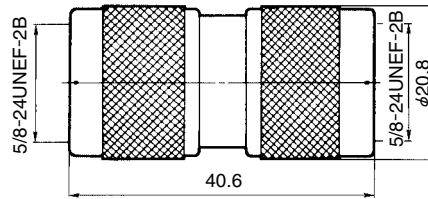

Part No.	HRS No.	Packaging
UG-57B/U(40)	301-0018-7 40	1

●Panel mount adaper (jack-jack type)

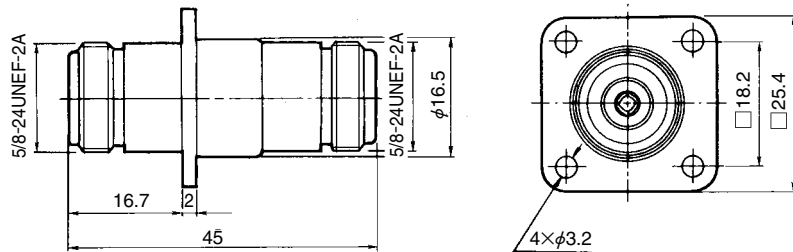

Part No.	HRS No.	Packaging
N-PA(42)	301-0036-9 42	1

●Right angle adapter (Plug-jack type)

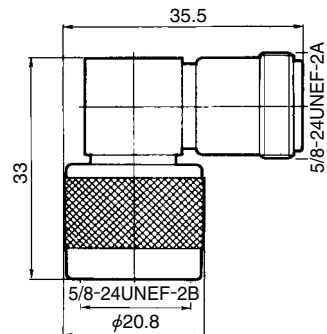

Part No.	HRS No.	Packaging
UG-27C/U(43)	301-0015-9 43	1

● T-shaped adapter
(Jack-jack-jack type)

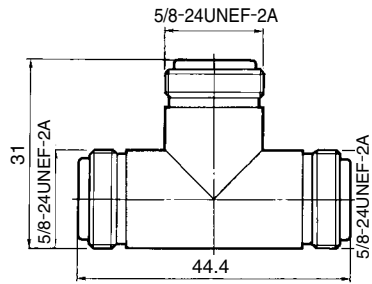

Part No.	HRS No.	Packaging
UG-28A/U(40)	301-0017-4 40	1

(Jack-plug-jack)

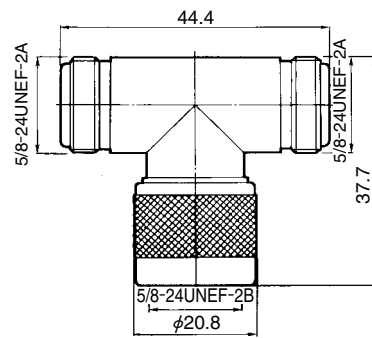

Part No.	HRS No.	Packaging
UG-107B/U(40)	301-0016-1 40	1

■ Conversion adapters

Mating portion 1		Mating portion 2		Part No.	HRS No.	Packaging	
Series name	Mating portion	Series name	Mating portion				
N	Plug	BNC	Plug	NP-BNCP(40)	311-0050-7 40	1	
			Jack	JUG-201A/U(40)	311-0007-8 40		
		S	Jack	N.P-S.J(40)	311-0245-6 40		
			SMA (HRM)	Plug	HRM-555S(40)		311-0125-4 40
		Jack		HRM-554S(40)	311-0123-9 40		
		Jack	BNC	Plug	UG-349/U(40)		311-0004-0 40
	Jack			NJ-BNCJ(40)	311-0005-2 40		
				NJ-BNCJ-PA(40)	311-0014-3 40		
	TNC		Plug	N.J-TNC.P(40)	311-0225-9 40		
	SMA (HRM)		Plug		HRM-553S		311-0121-3
					HRM-557SV		311-0272-9
		Jack		HRM-552S	311-0119-1		
			HRM-556SV	311-0298-2			

■ Cap

With a chain

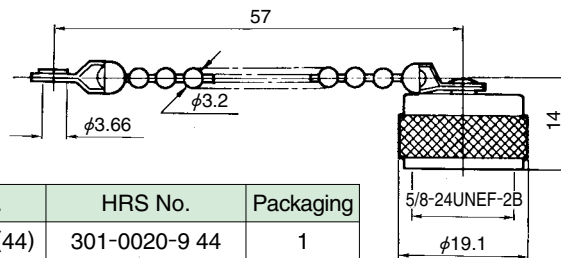

Part No.	HRS No.	Packaging
MX-913/U(44)	301-0020-9 44	1

Dec.1.2018 Copyright 2018 HIROSE ELECTRIC CO., LTD. All Rights Reserved.

◆ Cable assembly procedure

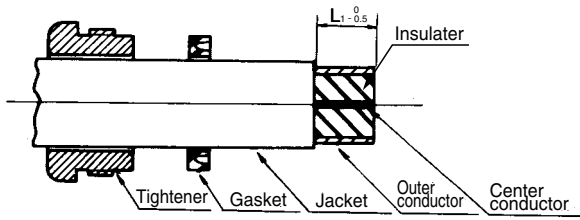

The cable ends are processed as shown in the drawing. For the dimensions L_1 , refer to Table 1, which shows dimensions arranged L by part number.

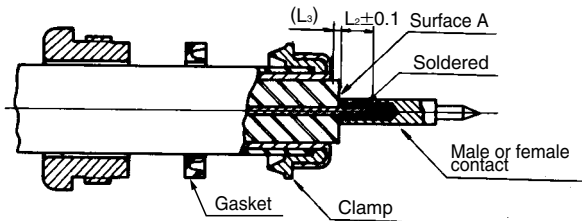

- (1) Insert clamp from tip of cable and fold outer conductor of cable back onto clamp. Using a knife, cut off excess outer conductor left at this time.
- (2) Cut off center conductor of cable at L_2 , from surface A of cable insulation. For dimensions of L_2 and L_3 , refer to Table 1. L_3 is a reference dimension.
- (3) Solder cable center conductor and male contact (or female contact). It is a good idea at this time to solder the contact preliminarily in advance.
(Note: There must be no gap between the contact and the cable insulation.)

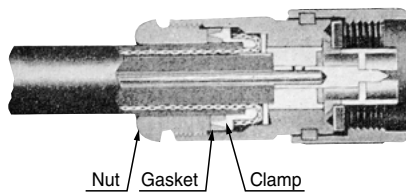

Insert cable and parts into shell and fit sharp end of clamp completely into V-shaped surface of gasket. Tighten tightening nut sufficiently.

■ Remarks

1. The cable dimensions L are based on the MIL and DSP standards. They may differ somewhat depending on the type of cable. In such cases, match the dimensions with the connectors.
2. Some clamps and gaskets does not have not V-shaped, but the assembling procedures are the same.

Table 1 Dimensions L arranged by part number

Unit : mm

Part No.	HRS No.	$L_1-0.5$	$L_2+0.1$	L_3
JUG-536/U(40)	301-0001-4 40	8.6	6	1
UG-21D/U(47)	301-0003-0 47	10		
N-LP-5DW(40)	301-0007-0 40	11.5	4	3.5
UG-23D/U(40)	301-0008-3 40	8.5	5	1
UG-22D/U(40)	301-0010-5 40			
N-PJ-58/U(40)	301-0011-8 40	7.4	3	3.2
N-LP-58U(40)	301-0076-3 40	9.2	4	3.6
N-P-3DV(41)	301-0078-9 41	12.3	6	4.8
N-P-5DV(40)	301-0120-3 40	11.1		1.5
N-P-5DW(32)	301-0199-3 32	12.0		
N-P-5DFB(40)	301-0205-4 40	11		5
N-P-10DFB(31)	301-0206-7 31			

■ Non-reflective Terminators (Coupling portion plug)

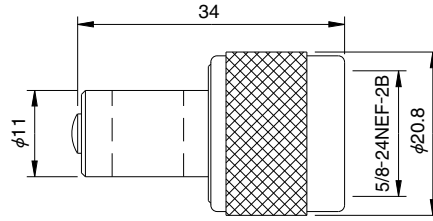

Part No.	HRS No.	Frequency range (GHz)	V.S.W.R.(Max)			Power (W)	Weight (g)	Packaging
			DC~4GHz	4~6GHz	6~8GHz			
N-TMP-1-1(50)	353-0137-5 50	DC~8	1.10	1.15	1.20	1	59	1

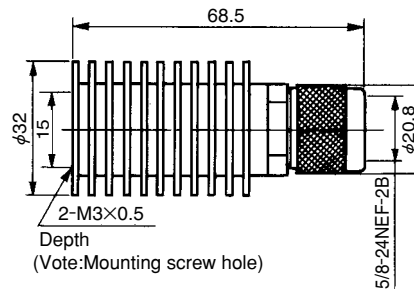

Part No.	HRS No.	Frequency range (GHz)	V.S.W.R.(Max)		Power (W)	Weight (g)	Packaging
			DC~2GHz	2~6GHz			
N-TMP-5(40)	353-0033-0 40	DC~6	1.15	1.20	5	113	1

Dec.1.2018 Copyright 2018 HIROSE ELECTRIC CO., LTD. All Rights Reserved.

Fixed Attenuators(plug-jack)

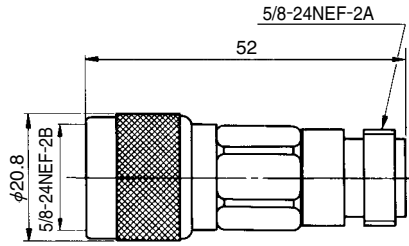

Part No.	HRS No.	Frequency range (GHz)	V.S.W.R.(Max)			Attenuation(dB)			Power (W)	Weight (g)	Packaging
			DC~2GHz	2~4GHz	4~13GHz	DC~2GHz	2~4GHz	4~13GHz			
AT-401(40)	354-0081-9 40	DC~13	1.15	1.20	1.25	1±0.3	1 ^{+0.5} _{-0.3}	1 ^{+0.6} _{-0.3}	2	77	1
AT-402(40)	354-0082-1 40					2±0.3	2 ^{+0.5} _{-0.3}	2 ^{+0.6} _{-0.3}			
AT-403(40)	354-0033-6 40					3±0.3	3 ^{+0.5} _{-0.3}	3 ^{+0.7} _{-0.3}			
AT-406(40)	354-0034-9 40					6±0.3	6 ^{+0.5} _{-0.3}	6 ^{+0.7} _{-0.3}			
AT-410(40)	354-0035-1 40					10±0.5	10 ^{+0.8} _{-0.5}	10 ^{+1.0} _{-0.5}			
AT-420(40)	354-0036-4 40					20±0.5	20 ^{+0.8} _{-0.5}	20 ^{+1.2} _{-0.7}			

Typical data

Non-reflective Terminations

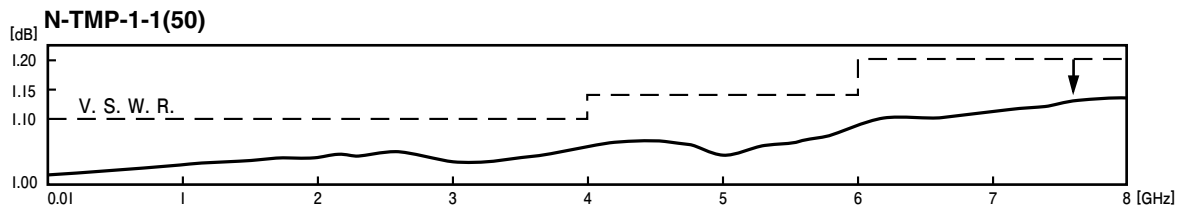

Fixed Attenuator

