

DATA SHEET

NTC THERMISTOR INRUSH CURRENT LIMITER SP SERIES

RoHS compliant & Halogen free



Product specification— February 19, 2021 V.0



NTC Thermistor SP series Data Sheet

Features

- Effectively restrain surge.
- Low power loss under the stable state.
- Over-current wide control range and fast response.
- Thermal and electrical characteristics with high stability.
- Wide range of electrical specifications.
- RoHS& Halogen Free (HF) compliant.
- Safety certification-UL / TUV

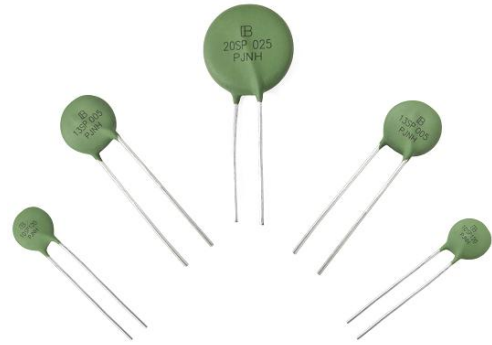

Applications

- Monitor, Sps, Fax, Telecom, Adaptor etc.
- Power supply, Communications equipment etc.

Part Number Code

N	08	SP	005	M	—	F	TR
NTC	Nominal Diameter	Series Code	R25 (Nominal Resistance at 25°C)	Tolerance of R25		Forming Type (Kink)	Packing
Negative Temperature Coefficient	08: 8mm, 10: 10mm, 13: 13mm, 15: 15mm, 20: 20mm, 25: 25mm	Surge Protection	0R7: 0.7Ω , 1R3: 1.3Ω, 2R5: 2.5 Ω, 001~008: 1~8Ω, 010~080: 10~80Ω, 120: 120Ω	L: ±15%, M: ±20%		No suffix: Straight leads O: Outside crimped leads F: Y Kinked leads	No suffix: Bulk, TB: Tape & Box, TR: Tape & Reel

Marking

- ① Brightking Logo
- ② Disk Size
- ③ SP SERIES
- ④ Zero Power Resistance at 25°C
- ⑤ Internal control code

Dimensions (Unit: mm)

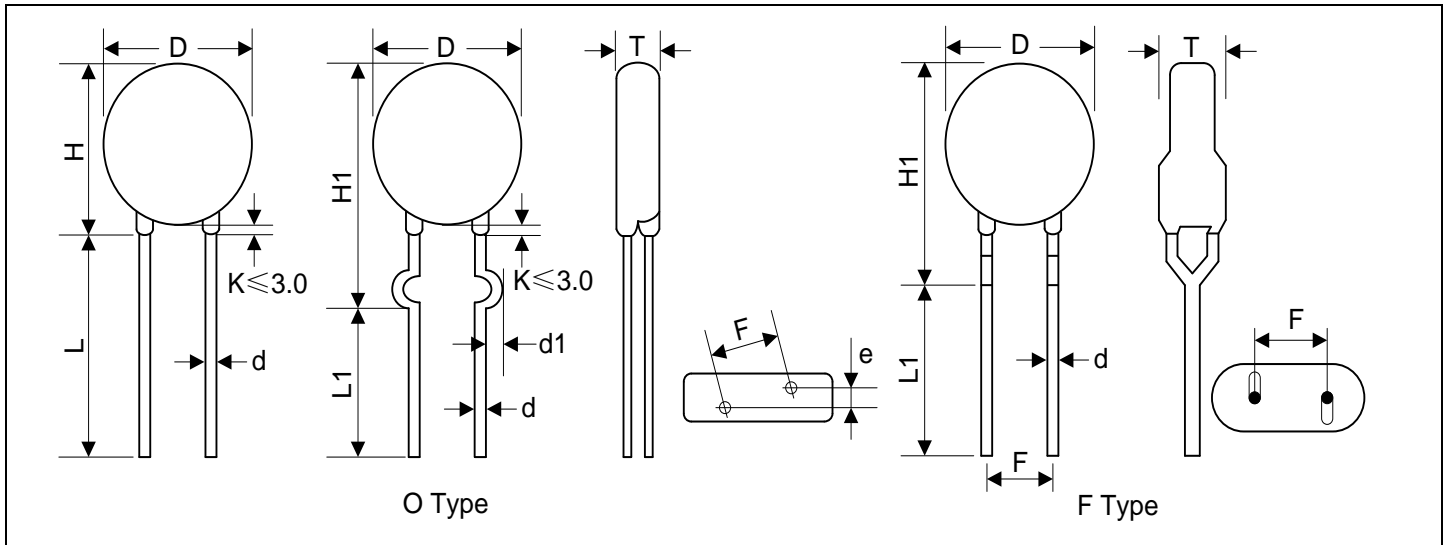

Disc Φ	D (max.)	H (max.)	H1 (max.)	L (Min.)	L1 (Min.)	d (±0.02)	d1 (±0.4)	T (max.)	F (±0.8)	e (±0.5)
08	11.0	13.5	14.0	20.0	15	0.80	1.4	6.0	5.0	2.0
10	13.5	16.0	18.0	20.0	15	0.80	1.4	6.0	5.0	2.1
13	16.0	19.0	22.0	20.0	15	1.00	1.6	6.0	7.5	2.9
15	18.0	21.0	25.0	20.0	15	1.00	1.6	6.5	7.5	3.1
20	24.0	28.0	33.0	20.0	15	1.00	1.6	7.5	7.5	3.6
25	29.0	32.5	38.0	20.0	15	1.00	1.6	7.5	7.5	3.6

Remarks: Straight lead shape is the default lead shape for normal SP series product.

Maximum Power Rating (Pmax)

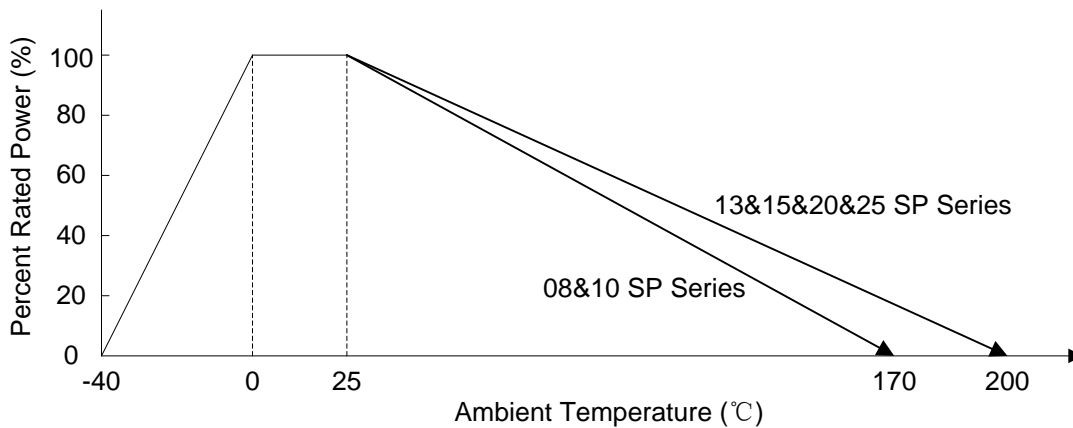

Specifications

Nominal Diameter (mm)	Part Number	Zero Power Resistance at 25°C	Maximum Steady State Current at 25°C	Residual Resistance at 25°C I _{max} R _{Imax}	Typical value		Recommend Capacitance 240Vac	Maximum Steady Power	Operating Temperature Range	U _L	T _{UV}
					Thermal Time Constant	Thermal Dissipation Constant					
					(s)	(mW/°C)					
		(Ω)	(A)	(Ω)	(s)	(mW/°C)	(μF)	(W)	(°C)		
08	N08SP003□	3	3	0.230	48	12	120	2.0	-40~+170	V	V
	N08SP004□	4	3	0.237	45	12	120	2.0	-40~+170	V	V
	N08SP005□	5	3	0.237	48	9	120	2.0	-40~+170	V	V
	N08SP006□	6	3	0.237	45	9	120	2.0	-40~+170	V	V
	N08SP008□	8	3	0.250	45	9	120	2.0	-40~+170	V	V
	N08SP010□	10	3	0.260	45	9	120	2.0	-40~+170	V	V
	N08SP015□	15	2	0.530	45	12	60	2.0	-40~+170	V	V
	N08SP020□	20	2	0.555	45	12	60	2.0	-40~+170	V	V
	N08SP022□	22	2	0.590	45	12	60	2.0	-40~+170	V	V
	N08SP033□	33	1.5	0.530	45	12	60	2.0	-40~+170	V	V
10	N10SP001□	1	5	0.090	65	17	330	2.5	-40~+170	V	V
	N10SP1R3□	1.3	5	0.090	63	17	330	2.5	-40~+170	V	V
	N10SP1R5□	1.5	5	0.095	60	15	330	2.5	-40~+170	V	V
	N10SP002□	2	5	0.099	55	12	330	2.5	-40~+170	V	V
	N10SP2R5□	2.5	5	0.102	58	11	330	2.5	-40~+170	V	V
	N10SP003□	3	5	0.106	60	11	330	2.5	-40~+170	V	V
	N10SP004□	4	4	0.163	62	10	330	2.5	-40~+170	V	V
	N10SP005□	5	4	0.168	58	10	330	2.5	-40~+170	V	V
	N10SP006□	6	3	0.250	59	10	220	2.5	-40~+170	V	V
	N10SP007□	7	3	0.262	60	13	220	2.5	-40~+170	V	V
	N10SP008□	8	3	0.265	59	12	220	2.5	-40~+170	V	V
	N10SP010□	10	3	0.273	56	12	220	2.5	-40~+170	V	V
	N10SP012□	12	2	0.504	58	11	220	2.5	-40~+170	V	V
	N10SP015□	15	2	0.500	62	11	220	2.5	-40~+170	V	V
	N10SP016□	16	2	0.501	62	11	220	2.5	-40~+170	V	V
	N10SP020□	20	2	0.557	60	12	220	2.5	-40~+170	V	V
	N10SP025□	25	2	0.555	56	12	220	2.5	-40~+170	V	V
	N10SP050□	50	2	0.723	58	10	220	2.5	-40~+170	V	V
N10SP080□	80	1	1.742	55	10	150	2.5	-40~+170	V	V	
N10SP120□	120	1	2.355	60	10	150	2.5	-40~+170	V	V	
N10SP150□	150	1	2.500	55	10	150	2.5	-40~+170	V	V	

NTC Inrush Current Limiter

SP series

Nominal Diameter (mm)	Part Number	Zero Power Resistance at 25°C	Maximum Steady State Current at 25°C	Residual Resistance at 25°C I _{max} R _{Imax}	Typical value		Recommend Capacitance 240Vac	Maximum Steady Power	Operating Temperature Range	U _L	T _{UV}
					Thermal Time Constant	Thermal Dissipation Constant					
		(Ω)	(A)	(Ω)	(s)	(mW/°C)	(μF)	(W)	(°C)		
13	N13SP1R3□	1.3	7	0.065	91	15	430	3.0	-40~+200	V	V
	N13SP1R5□	1.5	7	0.083	90	15	430	3.0	-40~+200	V	V
	N13SP2R5□	2.5	6	0.094	85	16	430	3.0	-40~+200	V	V
	N13SP003□	3	5	0.131	93	16	430	3.0	-40~+200	V	V
	N13SP004□	4	5	0.139	91	16	430	3.0	-40~+200	V	V
	N13SP005□	5	5	0.150	93	17	430	3.0	-40~+200	V	V
	N13SP006□	6	5	0.250	92	16	430	3.0	-40~+200	V	V
	N13SP007□	7	5	0.262	91	16	430	3.0	-40~+200	V	V
	N13SP008□	8	4	0.207	91	15	430	3.0	-40~+200	V	V
	N13SP010□	10	4	0.211	87	14	430	3.0	-40~+200	V	V
	N13SP012□	12	4	0.227	82	18	330	3.0	-40~+200	V	V
	N13SP016□	16	3	0.367	87	15	330	3.0	-40~+200	V	V
	N13SP018□	18	3	0.391	90	17	330	3.0	-40~+200	V	V
	N13SP020□	20	3	0.430	93	17	330	3.0	-40~+200	V	V
	N13SP025□	25	3	0.430	93	17	330	3.0	-40~+200	V	V
15	N15SP1R3□	1.3	8	0.059	107	20	640	4.0	-40~+200	V	V
	N15SP1R5□	1.5	8	0.064	107	19	640	4.0	-40~+200	V	V
	N15SP2R5□	2.5	8	0.070	104	20	640	4.0	-40~+200	V	V
	N15SP003□	3	7	0.089	105	20	640	4.0	-40~+200	V	V
	N15SP004□	4	6	0.115	104	18	640	4.0	-40~+200	V	V
	N15SP005□	5	6	0.122	110	20	640	4.0	-40~+200	V	V
	N15SP006□	6	5	0.160	102	20	640	4.0	-40~+200	V	V
	N15SP007□	7	5	0.188	99	21	640	4.0	-40~+200	V	V
	N15SP008□	8	5	0.186	103	15	640	4.0	-40~+200	V	V
	N15SP010□	10	5	0.182	103	19	640	4.0	-40~+200	V	V
	N15SP012□	12	4	0.252	102	21	560	4.0	-40~+200	V	V
	N15SP015□	15	4	0.260	101	17	560	4.0	-40~+200	V	V
	N15SP016□	16	4	0.285	102	22	560	4.0	-40~+200	V	V
	N15SP020□	20	4	0.292	101	20	560	4.0	-40~+200	V	V
	N15SP022□	22	4	0.302	101	20	560	4.0	-40~+200	V	V
	N15SP025□	25	3	0.482	100	21	560	4.0	-40~+200	V	V
	N15SP033□	33	3	0.490	100	21	560	4.0	-40~+200	V	V
	N15SP040□	40	3	0.496	101	20	560	4.0	-40~+200	V	V
	N15SP047□	47	3	0.517	102	21	560	4.0	-40~+200	V	V
	N15SP055□	55	3	0.534	102	21	560	4.0	-40~+200	V	V
N15SP080□	80	2.5	0.748	102	22	560	4.0	-40~+200	V	V	
N15SP120□	120	2	1.159	104	20	560	4.0	-40~+200	V	V	

NTC Inrush Current Limiter

SP series

Nominal Diameter (mm)	Part Number	Zero Power Resistance at 25°C	Maximum Steady State Current at 25°C	Residual Resistance at 25°C I _{max} R _{lmax}	Typical value		Recommend Capacitance 240Vac	Maximum Steady Power	Operating Temperature Range	U _L	U _V
					Thermal Time Constant	Thermal Dissipation Constant					
					(Ω)	(A)					
20	N20SP0R7□	0.7	12	0.039	145	25	820	5.0	-40~+200	V	V
	N20SP001□	1	10	0.051	135	25	820	5.0	-40~+200	V	V
	N20SP1R3□	1.3	8	0.064	144	24	820	5.0	-40~+200	V	V
	N20SP002□	2	8	0.072	140	21	820	5.0	-40~+200	V	V
	N20SP2R5□	2.5	8	0.073	120	23	820	5.0	-40~+200	V	V
	N20SP004□	4	8	0.087	135	25	820	5.0	-40~+200	V	V
	N20SP005□	5	7	0.107	144	24	820	5.0	-40~+200	V	V
	N20SP006□	6	6	0.156	136	24	820	5.0	-40~+200	V	V
	N20SP007□	7	6	0.156	132	24	820	5.0	-40~+200	V	V
	N20SP008□	8	6	0.157	135	24	820	5.0	-40~+200	V	V
	N20SP010□	10	6	0.158	135	23	820	5.0	-40~+200	V	V
	N20SP012□	12	5	0.205	132	25	820	5.0	-40~+200	V	V
	N20SP020□	20	6	0.197	127	22	740	5.0	-40~+200	V	V
	N20SP025□	25	6	0.197	127	22	740	5.0	-40~+200	V	V
	N20SP120□	120	2	1.222	142	24	740	5.0	-40~+200	V	V
25	N25SP001□	1	15	0.037	150	30	1240	6.5	-40~+200	V	V
	N25SP1R5□	1.5	15	0.036	150	30	1240	6.5	-40~+200	V	V
	N25SP002□	2	15	0.049	150	30	1240	6.5	-40~+200	V	V
	N25SP2R5□	2.5	15	0.051	150	30	1240	6.5	-40~+200	V	V
	N25SP003□	3	15	0.059	150	30	1240	6.5	-40~+200	V	V
	N25SP004□	4	14	0.054	150	30	1240	6.5	-40~+200	V	V
	N25SP4R7□	4.7	13	0.043	150	30	1240	6.5	-40~+200	V	V
	N25SP005□	5	12	0.066	150	30	1240	6.5	-40~+200	V	V
	N25SP6R8□	6.8	10.5	0.073	150	30	820	6.5	-40~+200	V	V
	N25SP007□	7	10	0.079	150	30	820	6.5	-40~+200	V	V
	N25SP008□	8	9	0.095	150	30	820	6.5	-40~+200	V	V
	N25SP010□	10	8	0.118	150	30	820	6.5	-40~+200	V	V
	N25SP012□	12	7.5	0.132	150	30	820	6.5	-40~+200	V	V
	N25SP015□	15	6.5	0.186	150	30	740	6.5	-40~+200	V	V
	N25SP018□	18	5.5	0.237	150	30	740	6.5	-40~+200	V	V
N25SP020□	20	5	0.237	150	30	740	6.5	-40~+200	V	V	

Remarks: □ means tolerance of R25 , L:± 15%, M:± 20%,

Reliability Test Requirements

Test items Reference standard	Test conditions			Criterion
High Temperature Storage IEC 60068-2-2	T _U ±5℃, 1000±24hrs			No visible damage ΔR25/R25 ≤ 20%
Damp Heat, Steady State IEC 60068-2-78	40±2℃, 90~95%RH , 1000±24hrs			No visible damage ΔR25/R25 ≤ 20%
Endurance IEC 60539-1	25±5℃ , I _{max} .1000±24hrs			No visible damage ΔR25/R25 ≤ 20%
Rapid Change of Temperature IEC 60068-2-14	Step	Temperature (°C)	Period (min.)	No visible damage ΔR25/R25 ≤ 20%
	1	T _L ± 5	30±3	
	2	Room	5±3	
	3	T _U ± 5	30±3	
	4	Room	5±3	
5 Cycles				
Capacitance test standard specifications	25±5℃ , C _{th} , interval 2mins, , Number of cycles: 1000 , C _{th} =Capacitance at 340 VDC			No visible damage ΔR25/R25 ≤ 20%
Cyclic endurance IEC 60539-1	25±5℃ , I _{max} .1min ON/5min OFF*1000cycles;			No visible damage ΔR25/R25 ≤ 20%
Insulation Test MIL-STD-202F-Method 302	1000 VDC, 1min			No visible damage
Tensile Strength of Terminals IEC 60068-2-21	Gradually applying the force specified and keeping the unit fixed for 10±1 sec.			No visible damage ΔR25/R25 ≤ 10 %
	Terminal diameter (mm)		Force (kg)	
	0.5<d ≤ 0.8		1.0	
	0.8<d ≤ 1.25		2.0	
Bending Strength of Terminals IEC60068-2-21	Follow spec: Hold specimen and apply the force specified below to each lead. Bend the specimen to 90°, then return to the original position. Repeat the procedure in the opposite direction.			No visible damage ΔV/V1mA ≤ 5%
	Terminal diameter (mm)		Force (kg)	
	0.5<d ≤ 0.8		0.5	
	0.8<d ≤ 1.25		1.0	
	1.25<d		2.0	
Solderability IEC 60068-2-20	245 ± 3 °C , 3 ± 0.3 sec			≥ 95%
Resistance to Soldering Heat IEC 60068-2-20	260 ± 3 °C , 10 ± 1 sec			ΔR/R ≤ 5 %

Resistance–Temperature Characteristic Curves

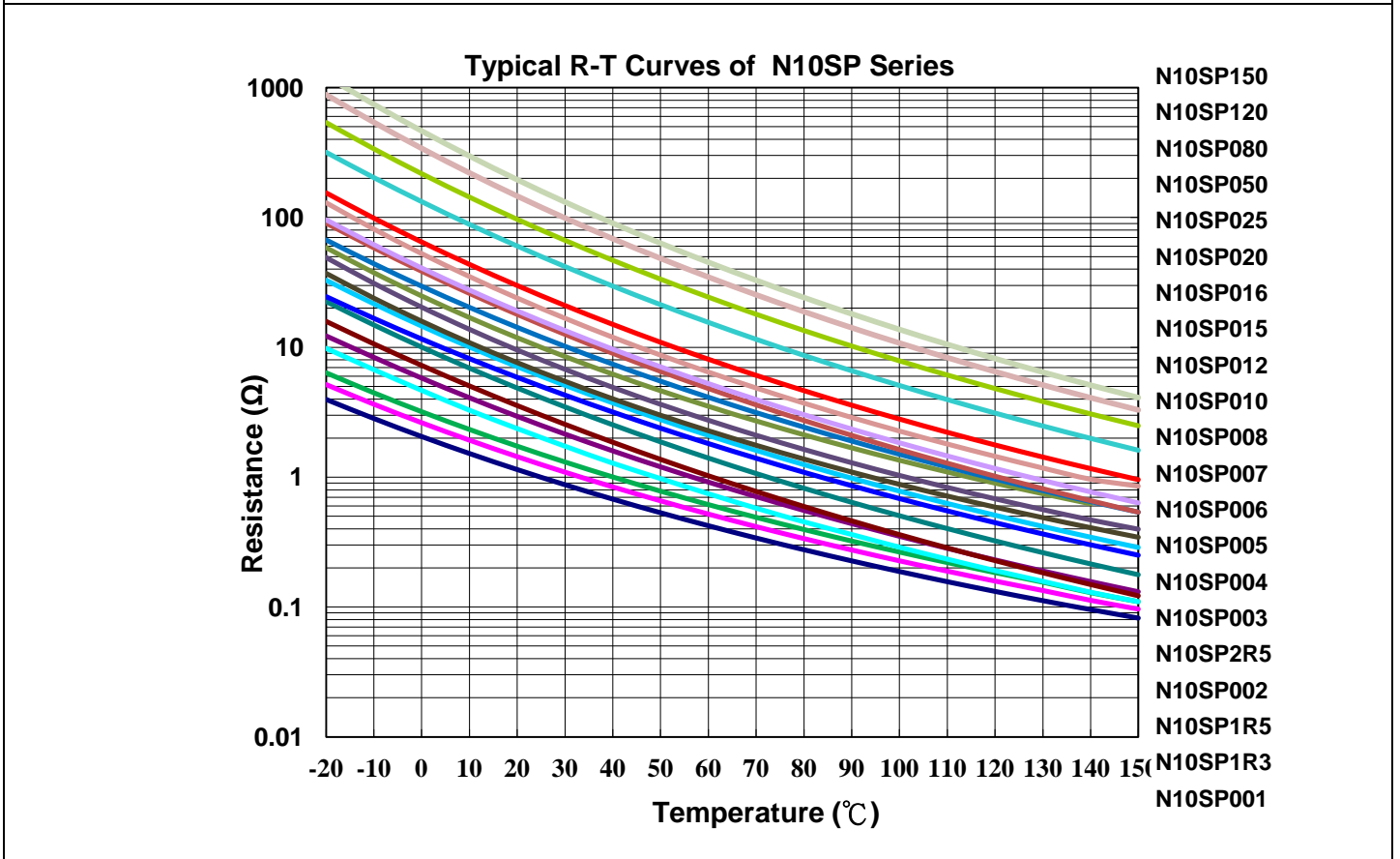
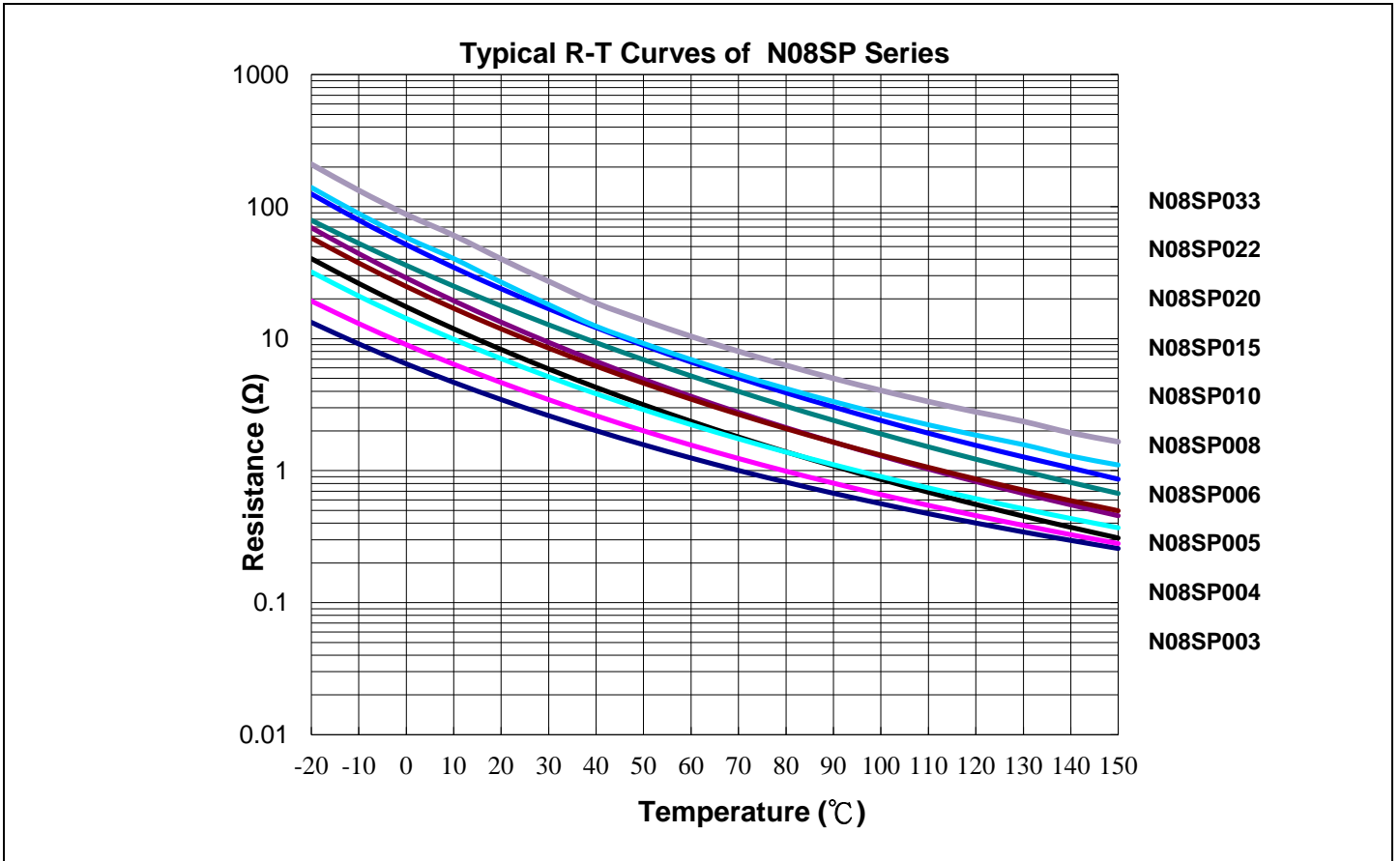

Resistance–Temperature Characteristic Curves

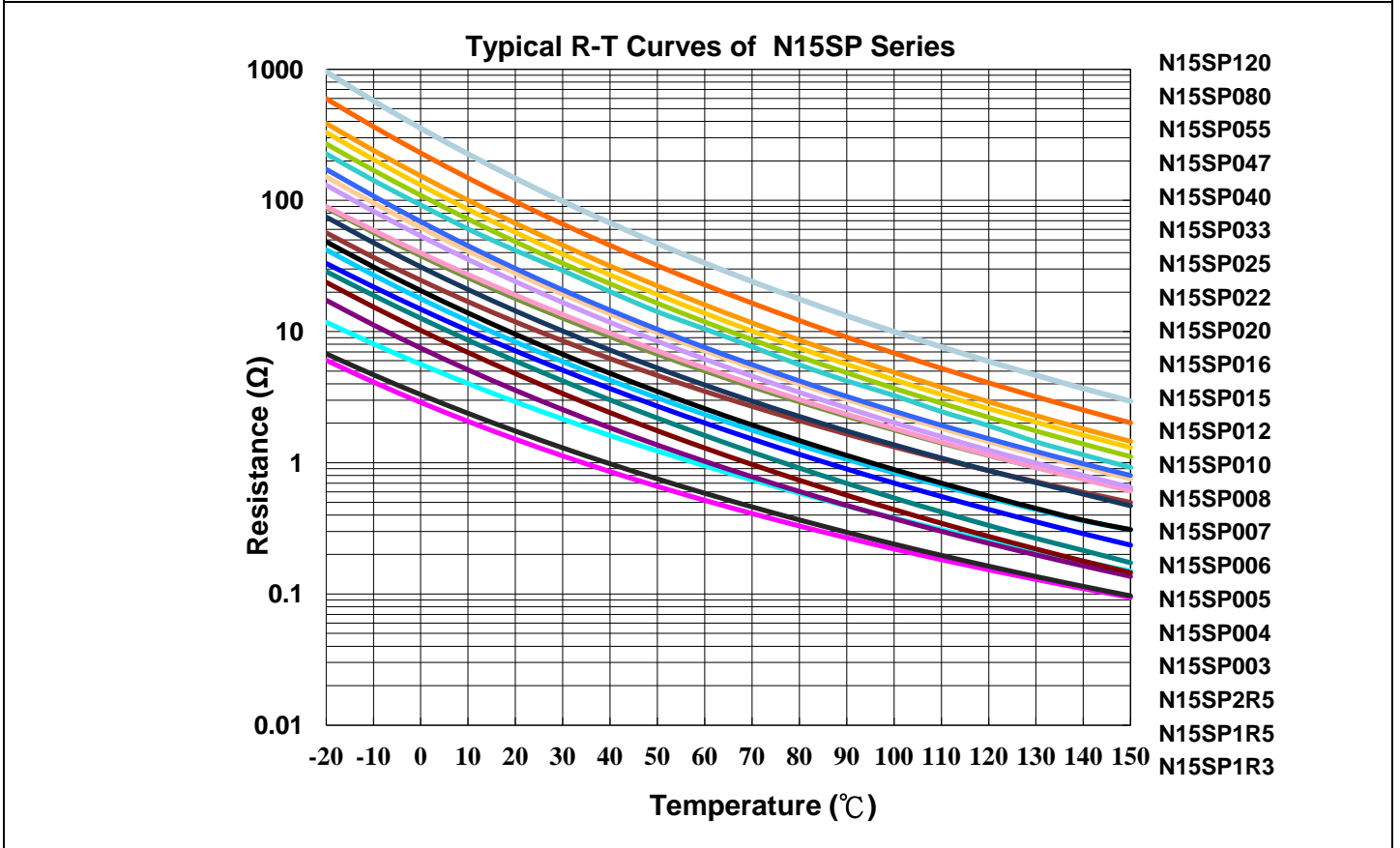
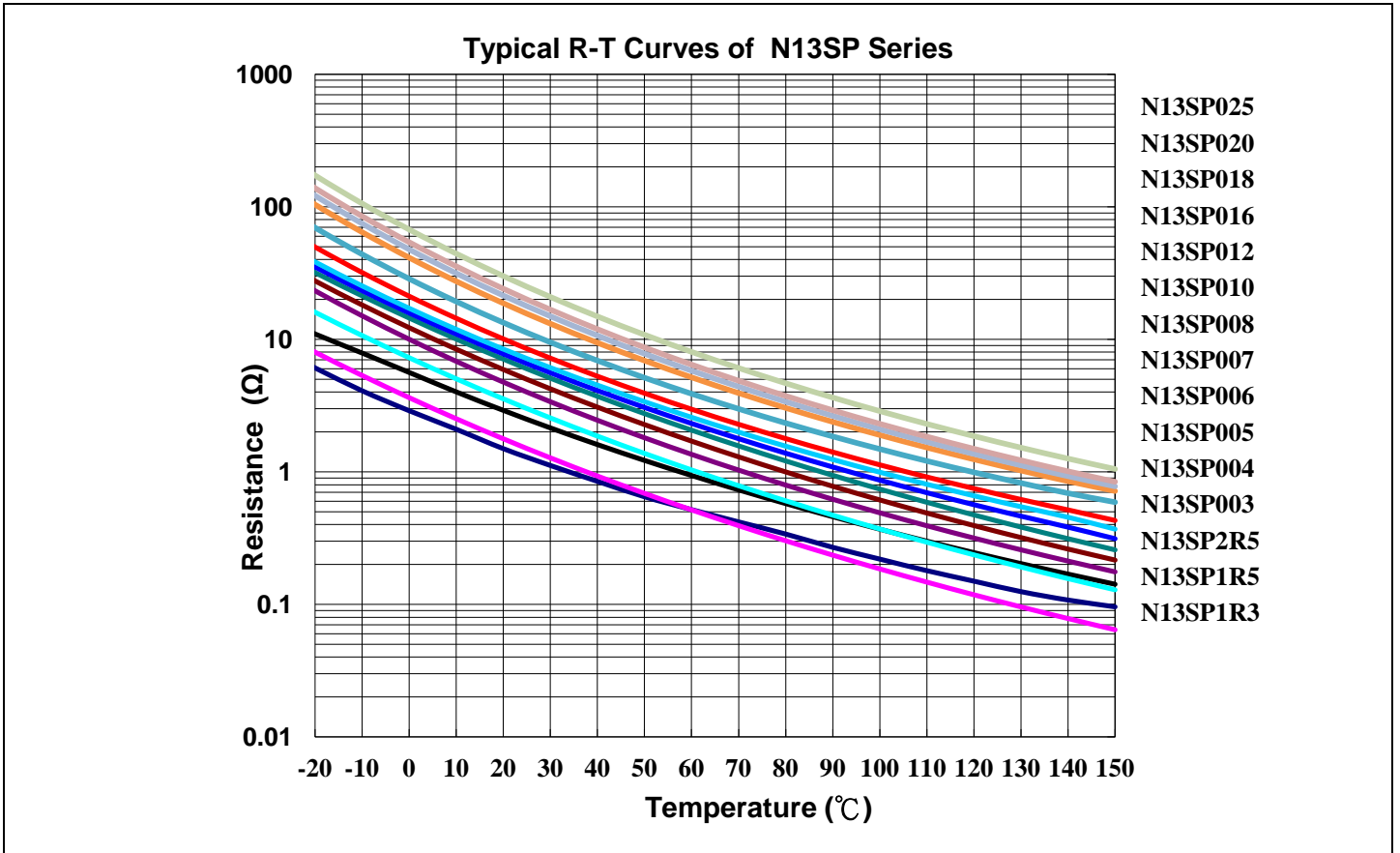

Resistance–Temperature Characteristic Curves

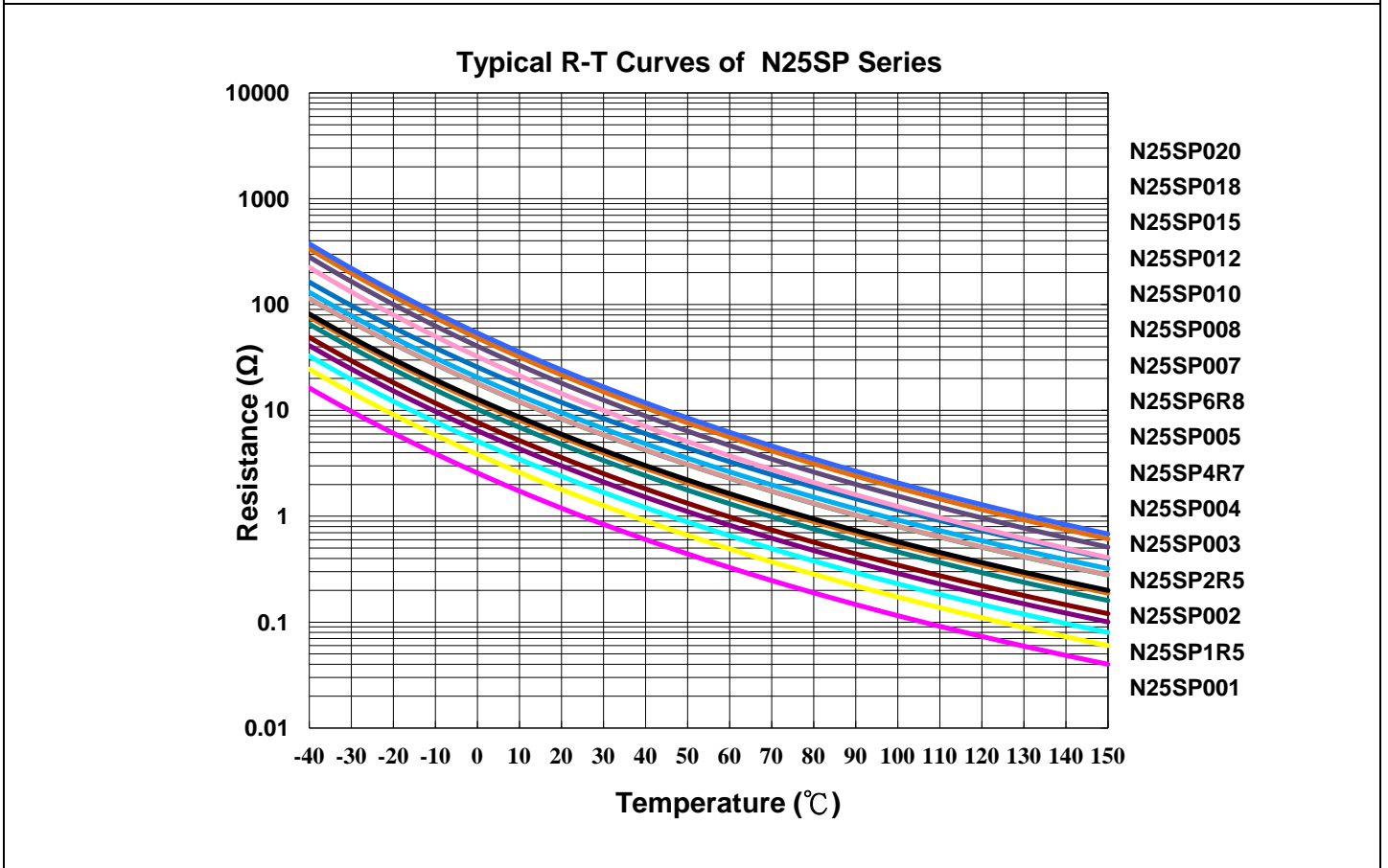
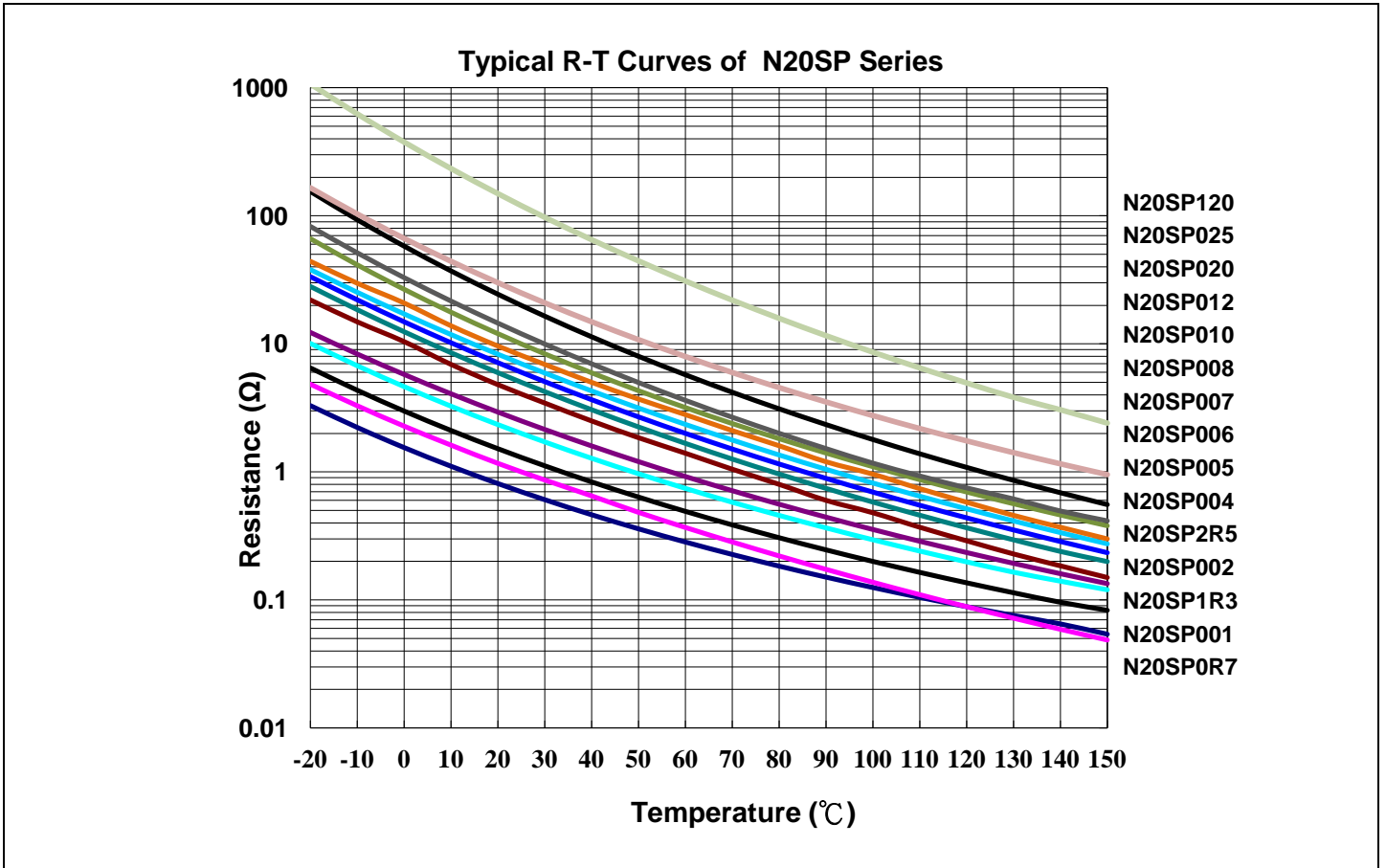

V-I Characteristic Curves

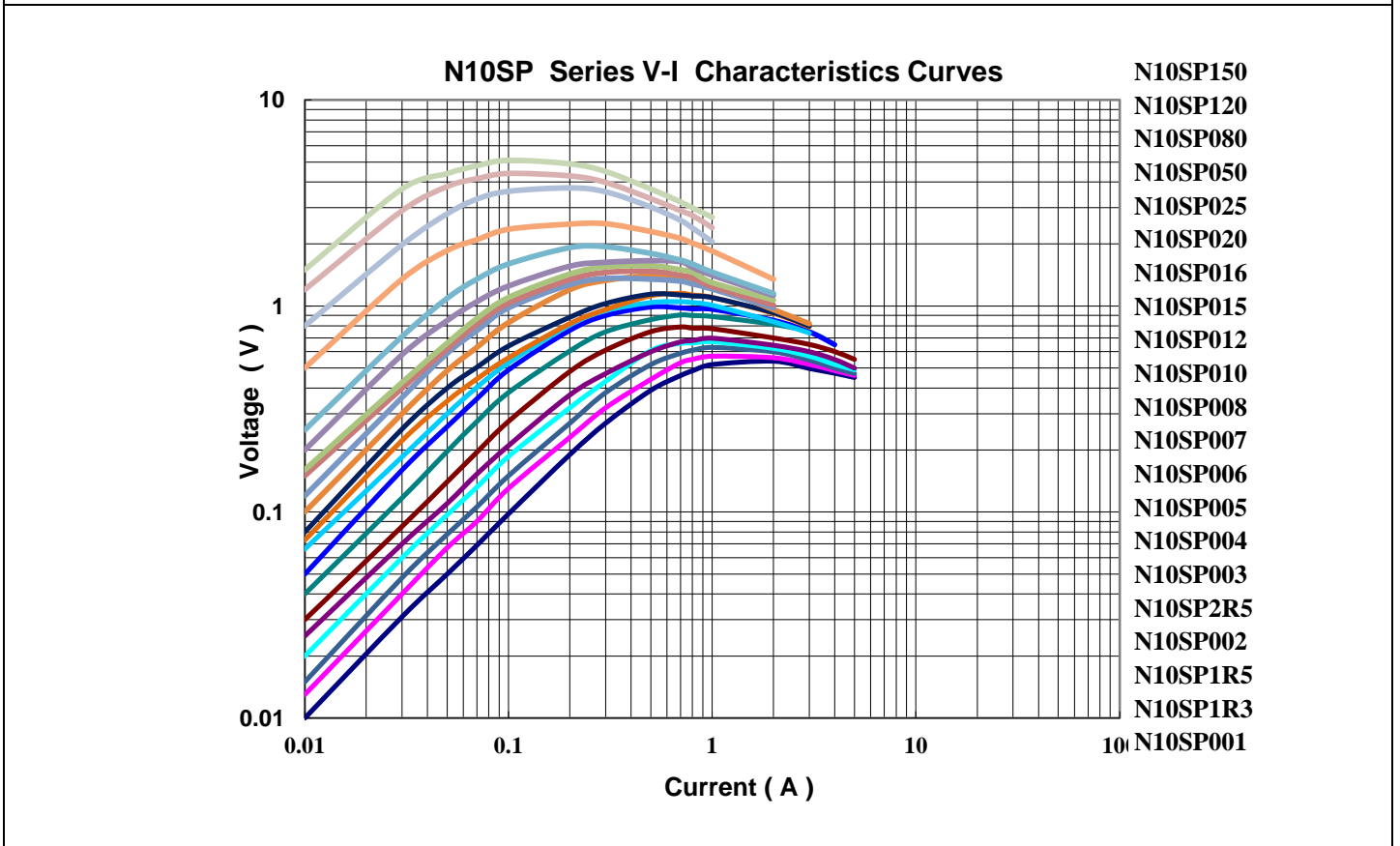
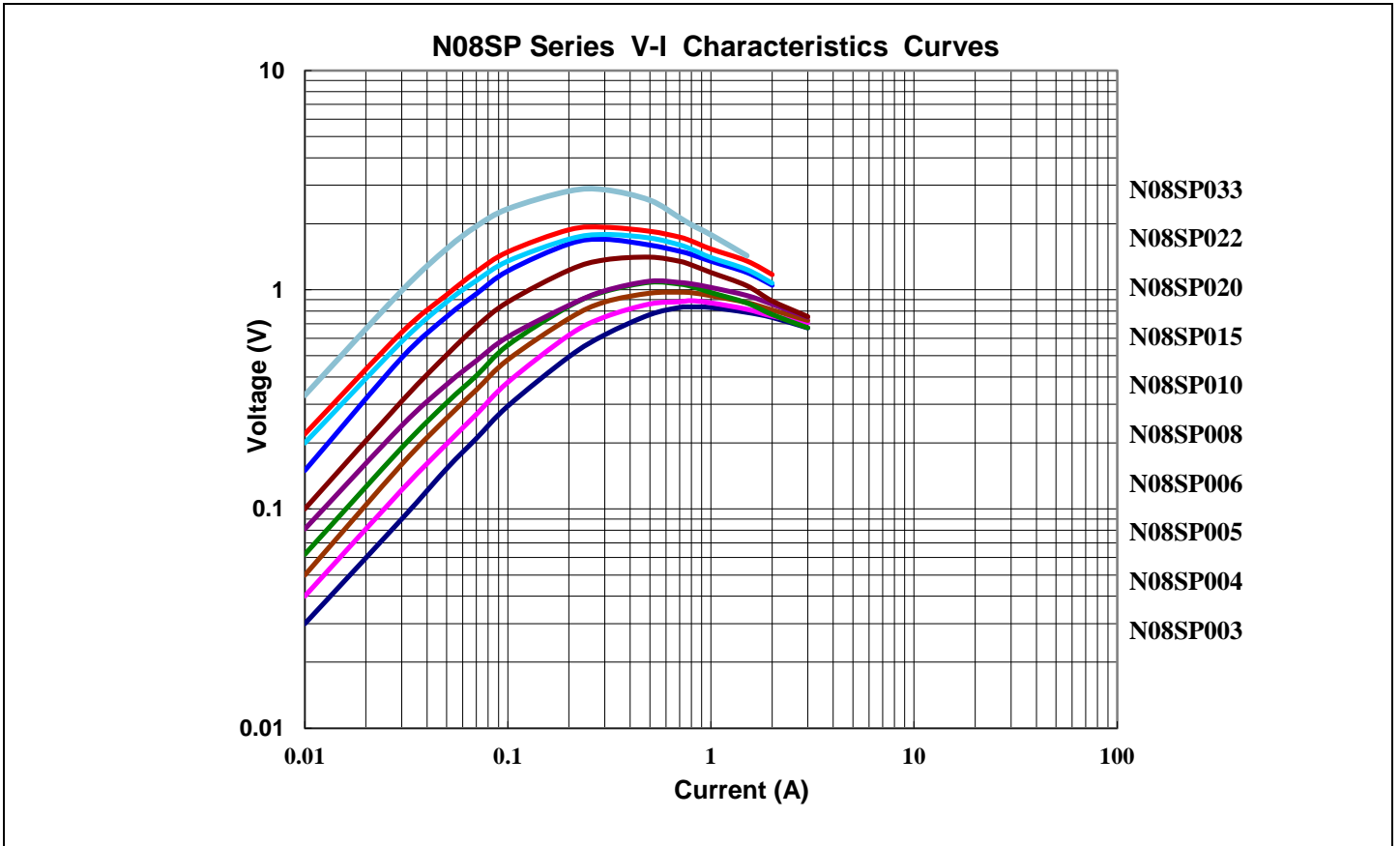

V-I Characteristic Curves

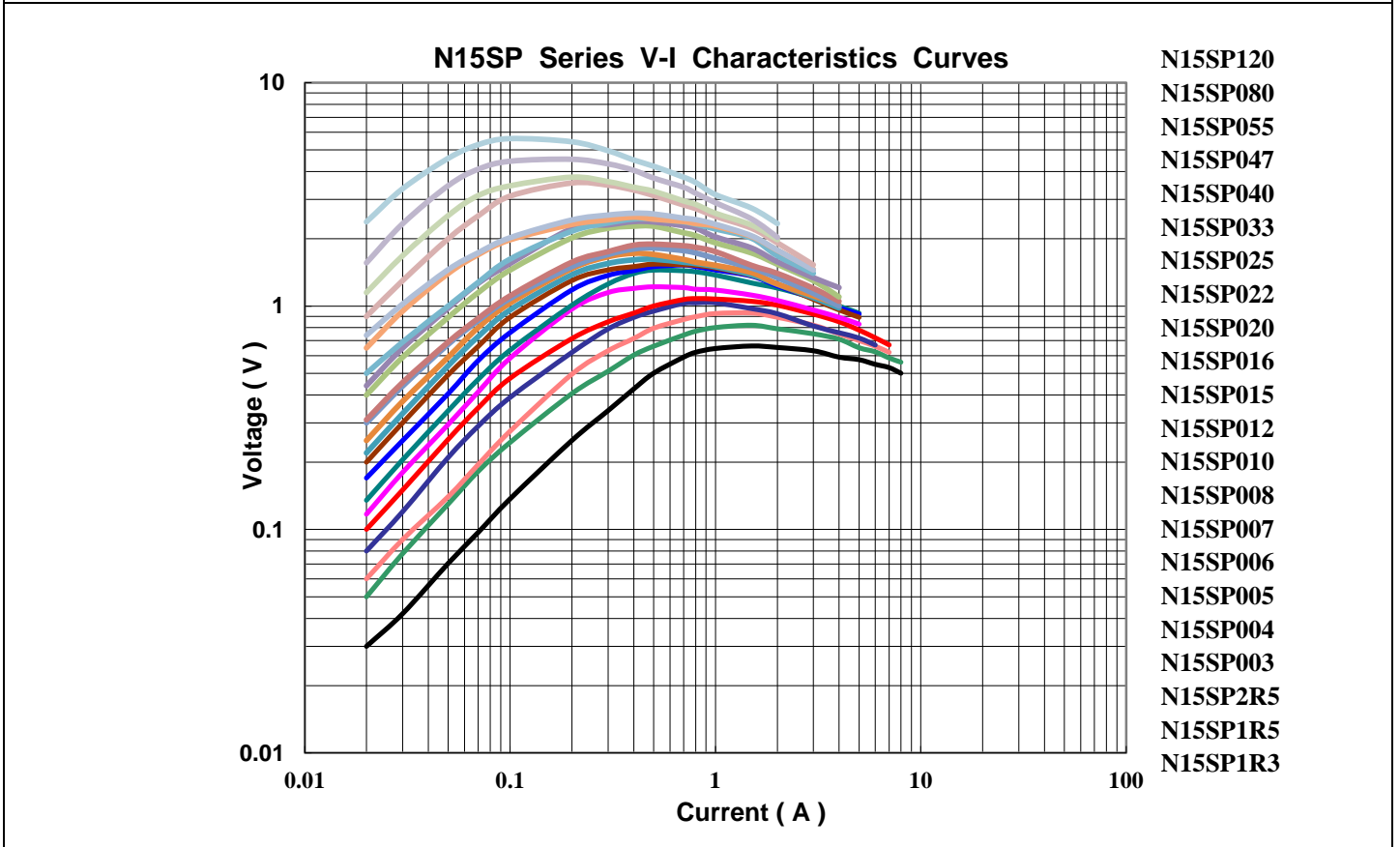
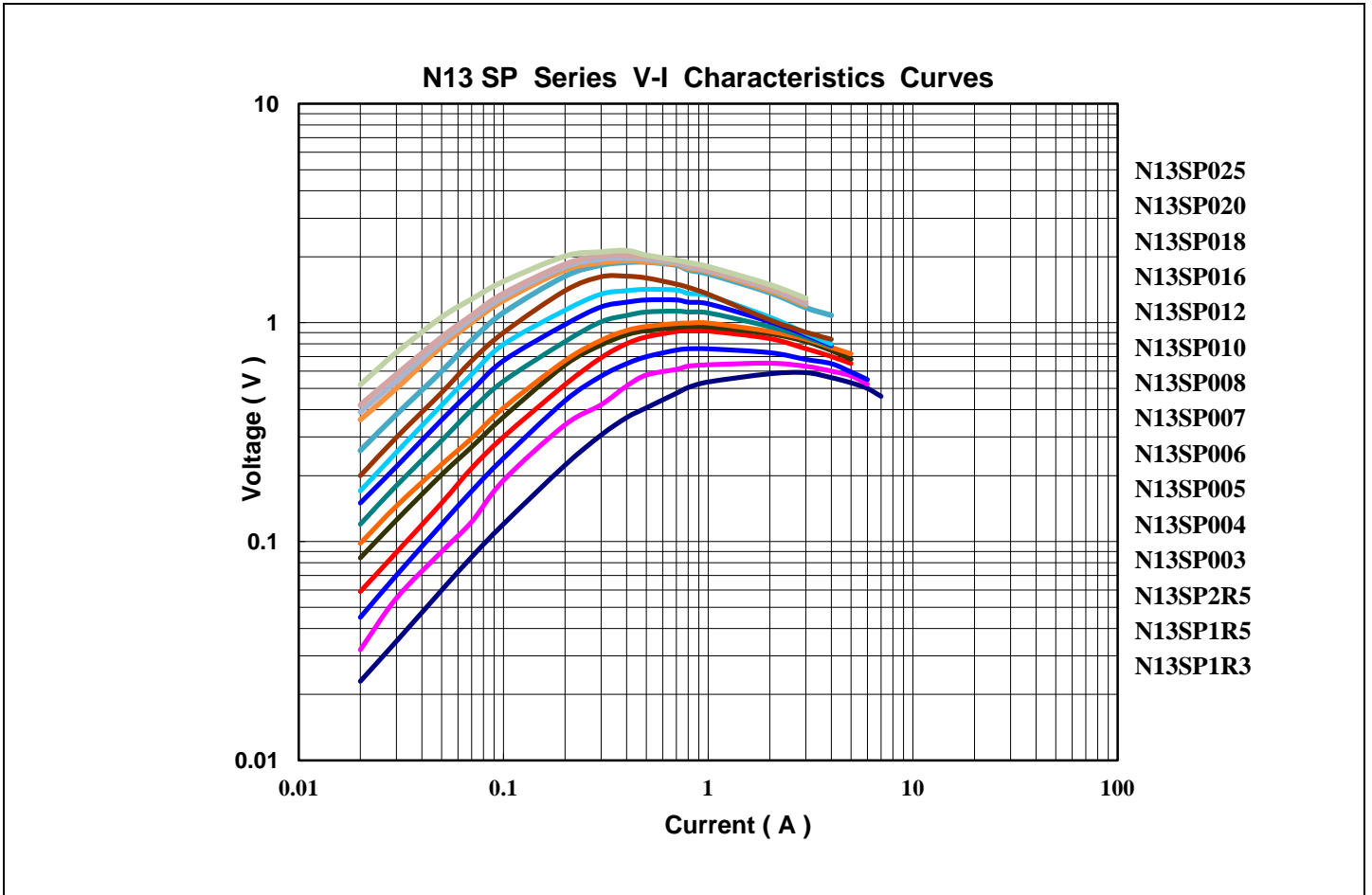

V-I Characteristic Curves

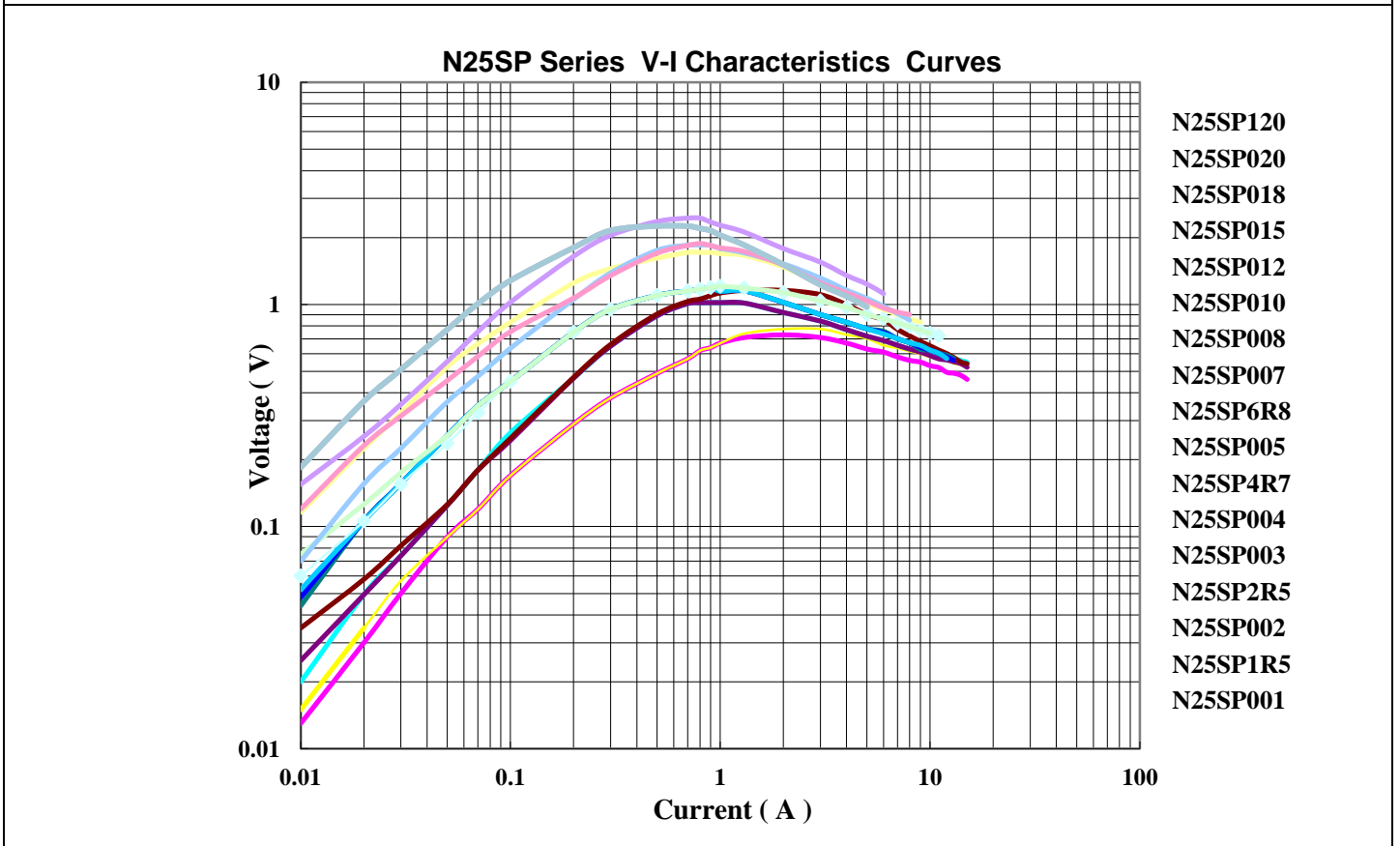
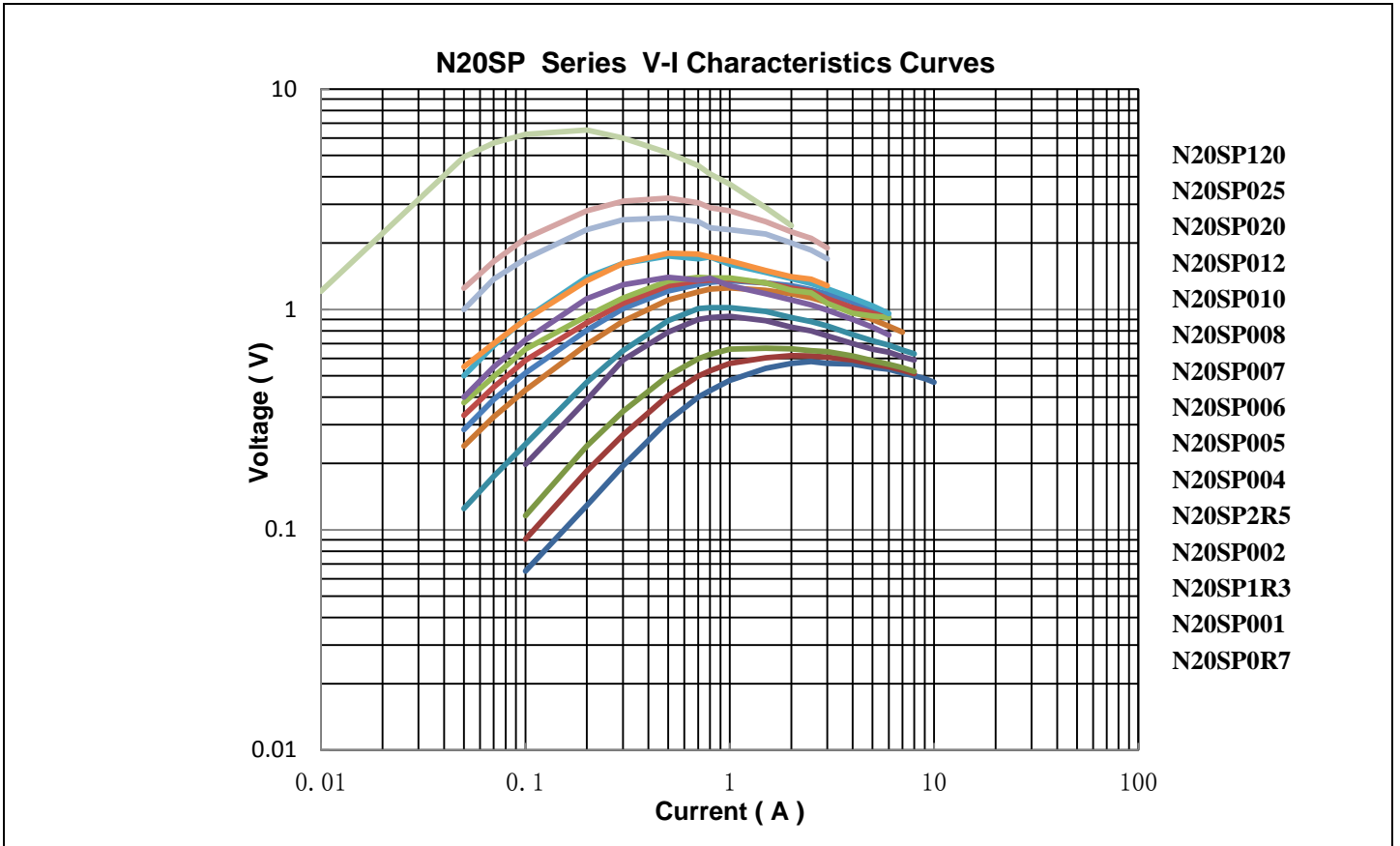

Soldering Recommendation

Wave Soldering Recommendation

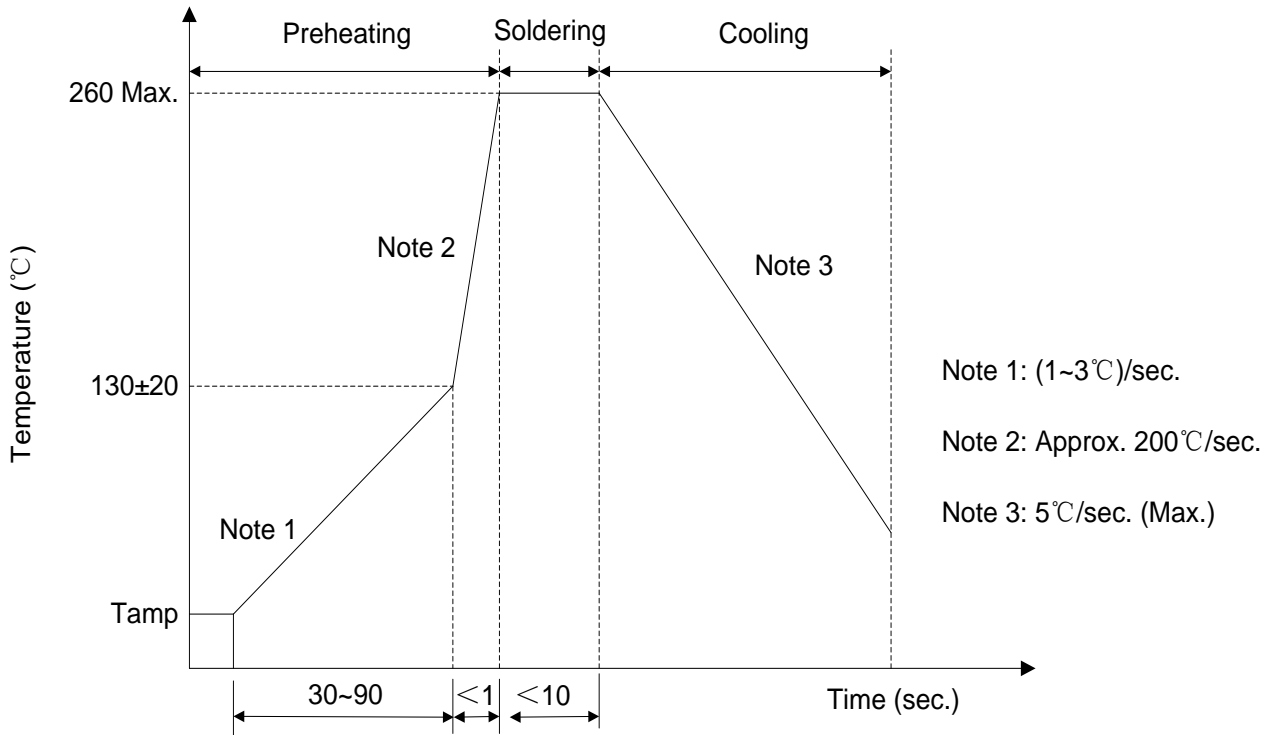

Recommended Reworking Conditions with Soldering Iron

Item	Conditions
Temperature of Soldering Iron-tip	360°C (max.)
Soldering Time	3 seconds (max.)
Distance from Thermistor	2mm (min.)

Packaging

■ Taping Packing

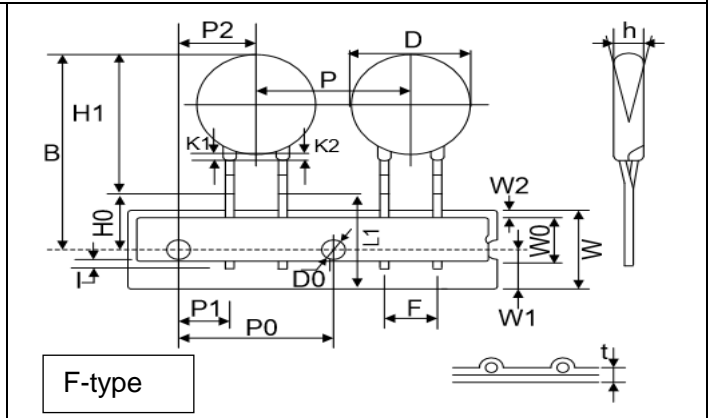
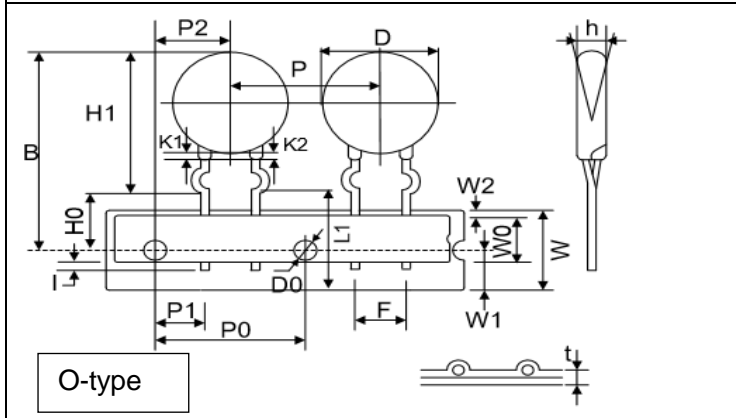
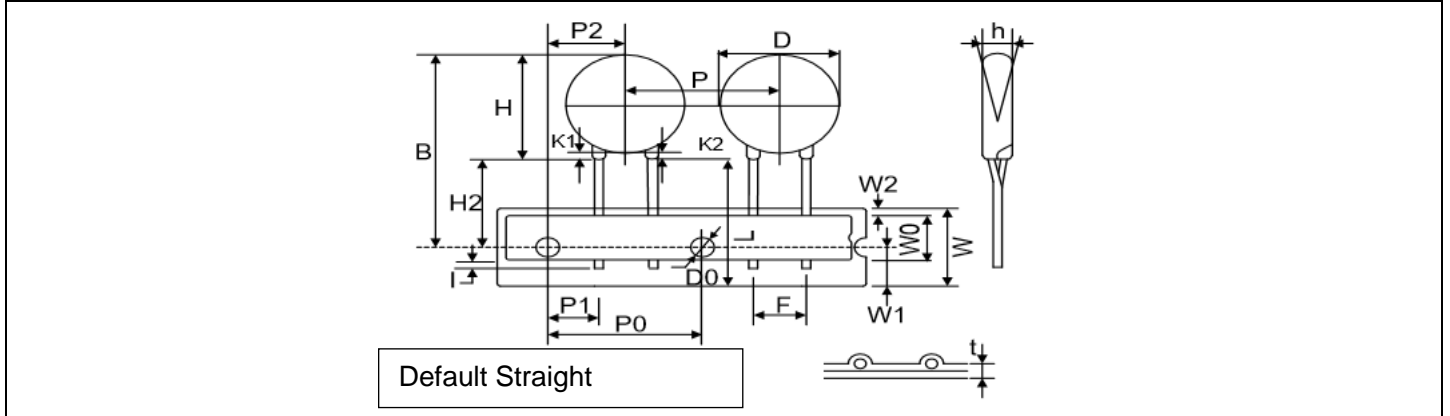
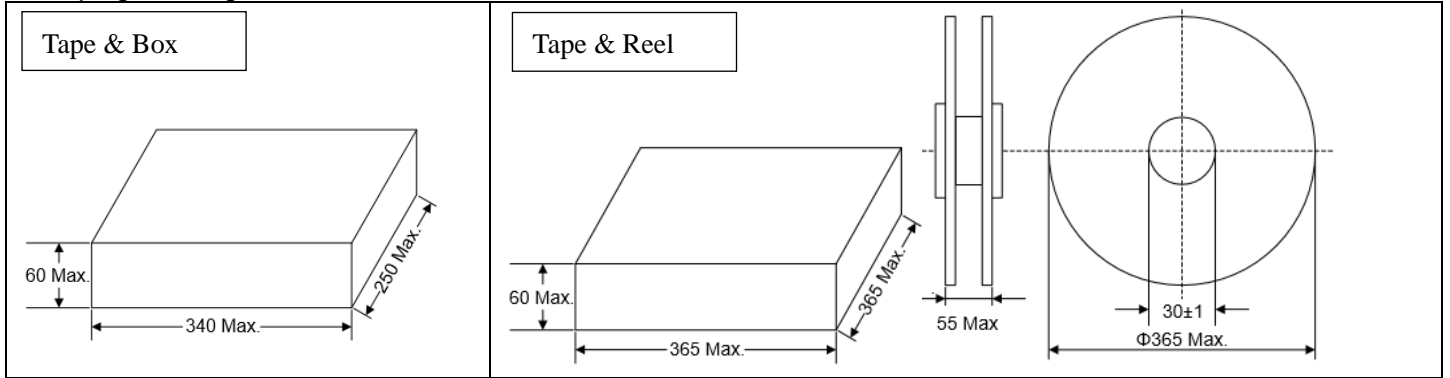

Dimensions	W	W0	W1	W2	H0	H2	D0	t	l
(Unit: mm)	18.0 ±1.0	12.0 ±1.0	9.0 +0.5/-0	Max 3.0	16.0 ±1.0	20.0 ±2.0	4.0 ±0.2	0.6 ±0.1	Max 2
Disc Φ	P0	P1 (±0.7)	P2 (+1.3/-0)	P (+1.0)	H (±1.0)	B (Max)		SPQ P0: 12.7mm	
								Taping & Box	Taping & Reel
8	12.7±0.3	3.85	6.35	12.7	0±2	33		1500pcs/Box	1500pcs/Box
10	12.7±0.3	3.85	6.35	25.4	0±2	36		500pcs/Box	600pcs/Box
13	12.7±1.0	8.95	12.7	25.4	0±4	40		500pcs/Box	600pcs/Box
15	12.7±1.0	8.95	12.7	25.4	0±4	42		500pcs/Box	600pcs/Box
20	12.7±1.0	8.95	12.7	25.4	0±4	45		400pcs/Box	400pcs/Box
25	/	/	/	/	/	/		/	/