

MATERIAL	FLAMMABILITY RATING	CONTINUOUS OPERATING TEMP.
ABS	UL94-HB	-40°C ~ +60°C / -40°F ~ 140°F
CLEAR PC	UL94-V0 UV STABILIZED	-40°C ~ +130°C / -40°F ~ 266°F
ABS / PC BLEND	UL94-5VA	-40°C ~ +85°C / -40°F ~ 185°F
PBT / PC BLEND	UL94-5VA + UV (f1)	-40°C ~ +75°C / -40°F ~ 167°F

FINISH:
 BODY _____ LIGHT GRAY
 COVER _____ LIGHT GRAY OR CLEAR
 LATCHES & HINGES _____ PLASTIC
 WALL MOUNTING BRACKETS _____ STAINLESS STEEL & HARDWARE

BODY

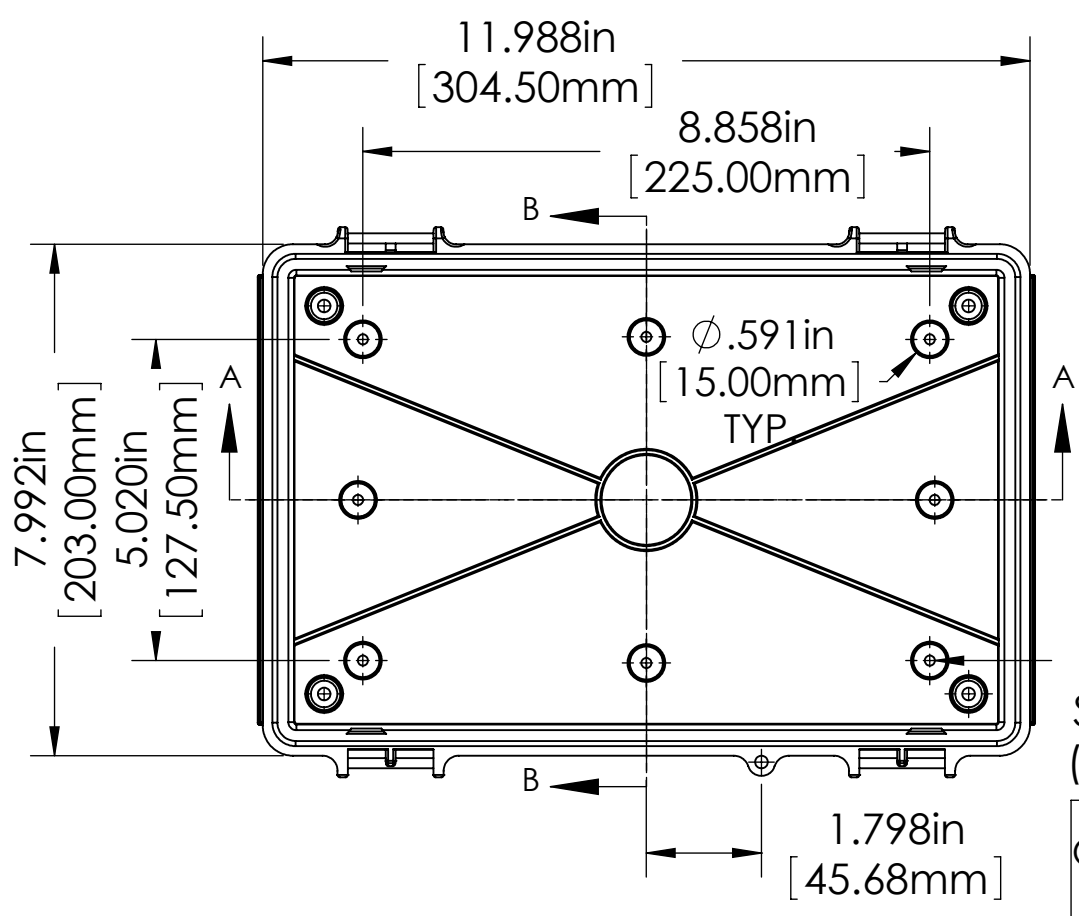

Ø.157in [4.00mm]
 FOR M5 x 10mm LG. SELF-TAPPING SCREWS (ABS VERSIONS ONLY)
 M5 THREADED INSERTS ON ALL OTHER VERSIONS USE M5 x 8mm LG. MACHINE SCREWS.

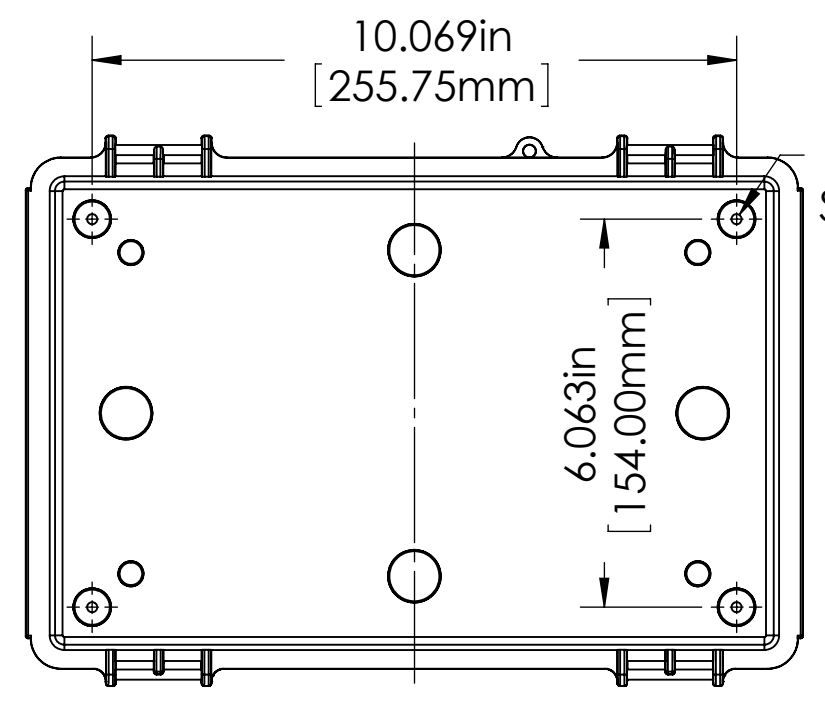
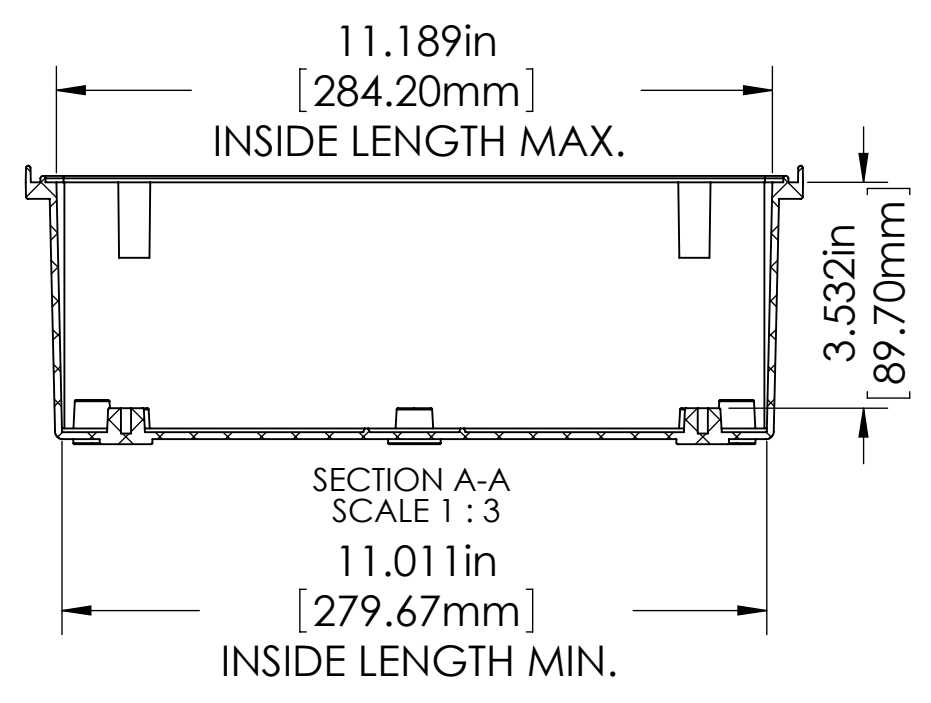
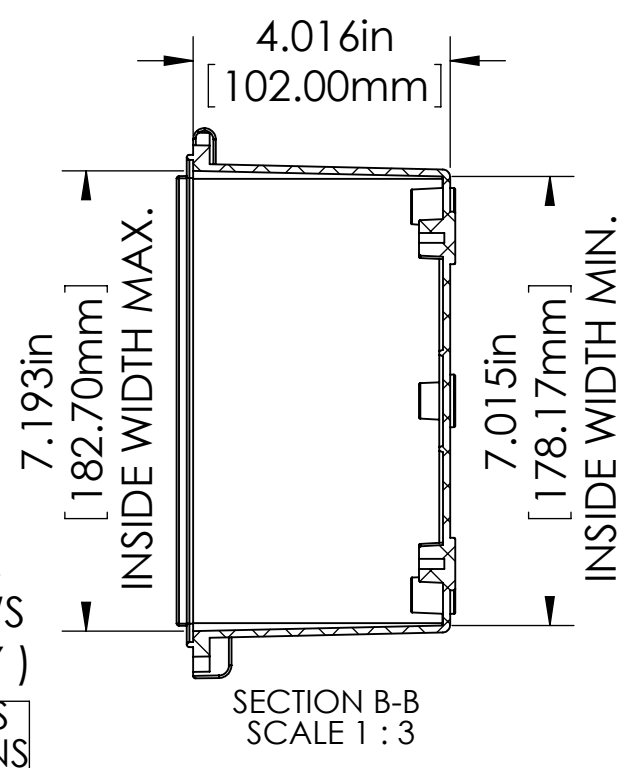

Ø.157in [4.00mm]
 FOR M5 x 10mm LG. SELF-TAPPING SCREWS 4 PLCS.

COVER

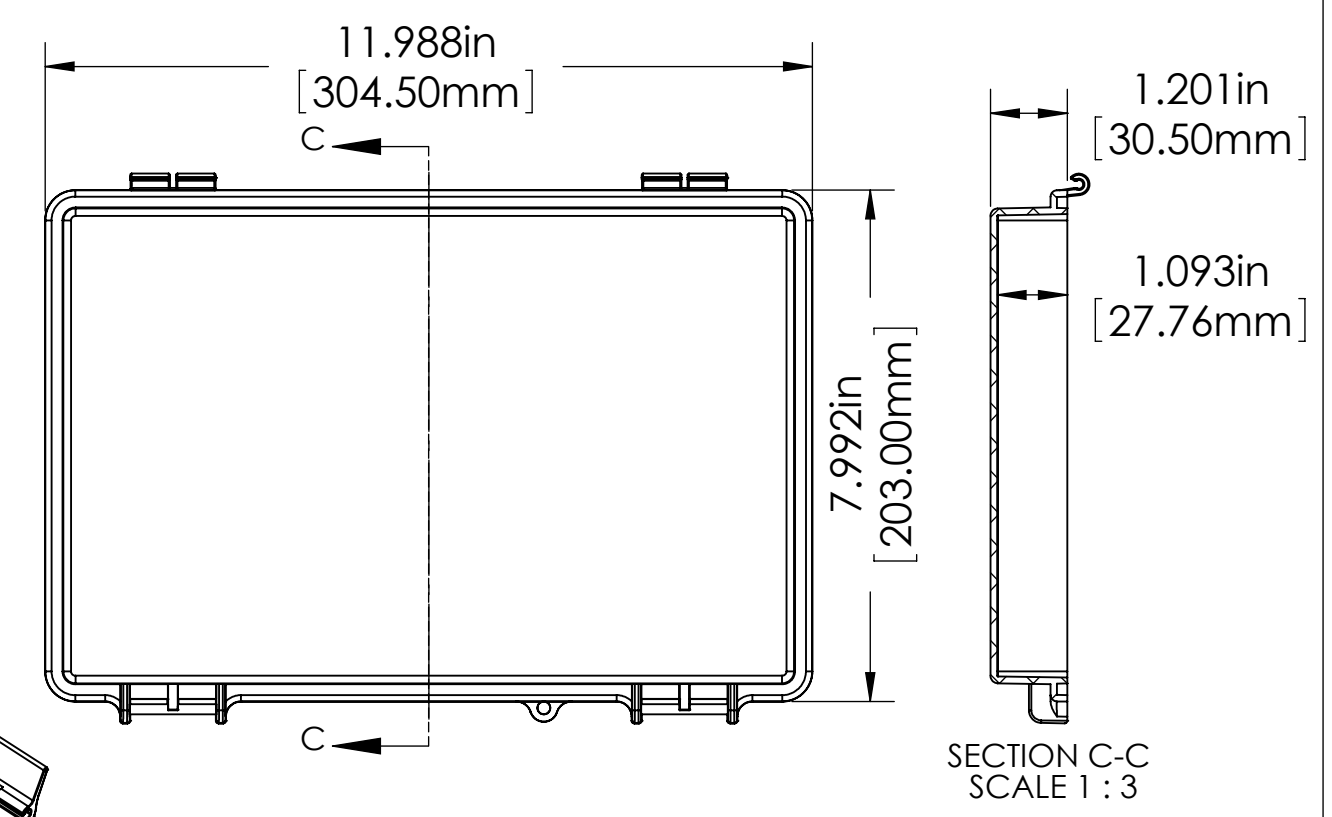

ASSEMBLY

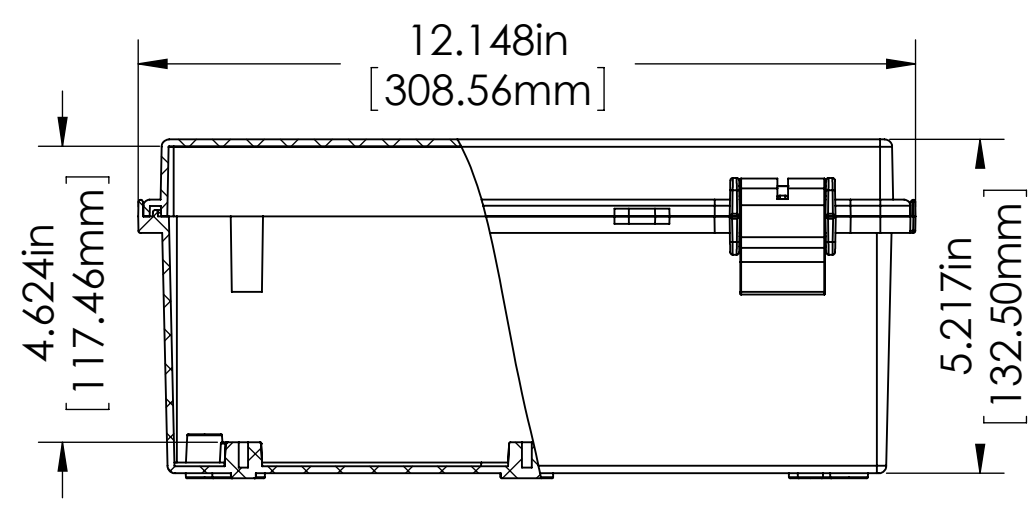
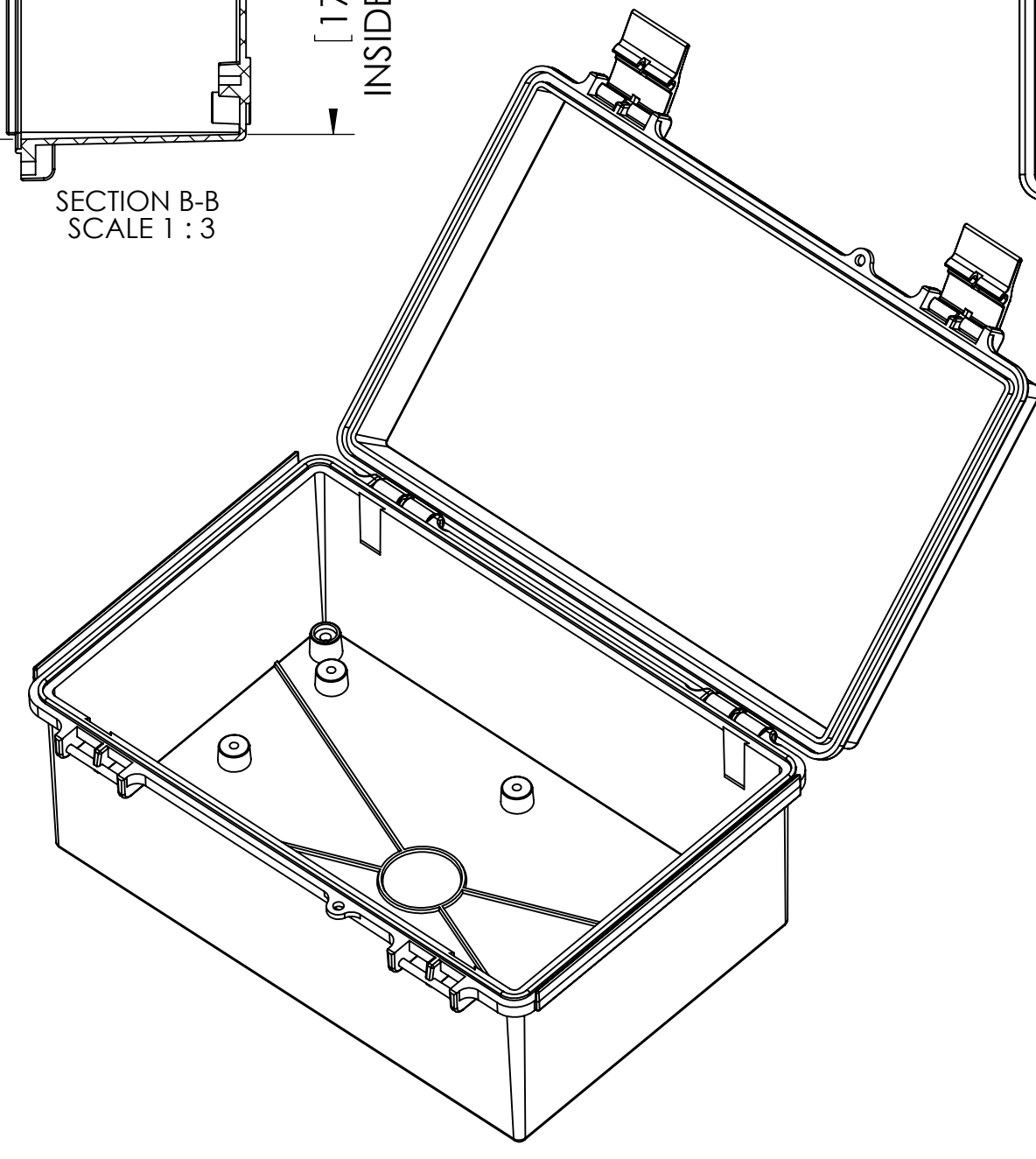

NOTES:

- 1) UNIT COMES COMPLETE WITH (4) WALL MOUNTING BRACKETS & (4) M5 x 10mm LG. SELF-TAPPING SCREWS. (NOT SHOWN)
- 2) BOXES DESIGNED TO MEET FOLLOWING STANDARDS: NEMA 1,2,4,4X, AND IEC529-IP65 REQUIREMENTS.

TOLERANCE:

ALL DIMENSIONS HAVE ±0.039in [±1mm] TOLERANCE UNLESS OTHERWISE SPECIFIED.

PART NO.	MATERIAL		USE
	BODY	COVER	
NBF-32016	ABS	ABS	INDOOR
NBF-32116	ABS / PC	ABS / PC	INDOOR
NBF-32216	ABS / PC	CLEAR PC	INDOOR
NBF-32316	PBT / PC	PBT / PC	OUTDOOR
NBF-32416	PBT / PC	CLEAR PC	OUTDOOR