



Neutrik® Part Number Guide

NC3FAH1-B-0-D

Packaging:	D	Cable connector: bulk packed
Assembly:	D	Chassis connector: disassembled push latch
Retention:	w/o	Latch lock
	-0	Retention spring
	-DA	Asymmetric PUSH
	B	Black shell, gold contacts
Shell:	BAG	Black shell, silver contacts
Grounding:	0	Separate ground contact connected to shell, male only
	1	Pin 1 & panel & shell connected, no separate ground contact
	2	Separate ground contact connected to shell & panel, separate Pin 1
	E	Additional ground contacts
	w/o number	No ground/shell contact (except 4/5 pole), female only
	Termination:	H
	HL	Lateral left PCB mount
	HR	Lateral right PCB mount
	L	Solder cups
	V	Verticale PCB mount
	Y	IDC for wires (no ground)
	M3	Mounting holes with M3 thread
	M25	Mounting holes with M2.5 thread
	-	Not applicable
Series:	A, AA, B, D, DL, DLX, MPR, P, PX, RX, X, XX	
Gender:	F	Female
	M	Male
Number of Contacts:	2, 3, 4, 5, 6, 7, 8, 12	
Connector Type:	A	Adapter
	AC	powerCON
	B	BNC
	C	XLR
	D	dummyPLUG
	E	etherCON - RJ45
	F	RCA / CINCH
	J (MJ, RJ, SJ)	Jack
	K	Cable Assembly
	L	speakON - Loudspeaker
	M	Module
	O	opticalCON - Fiber Optic Connector
	P	Plug
	PP	Patch Panel
	R	Circular Connector
	T	Transformer

Definitions, abbreviations & useful information see page 186.



XLR Connectors



Content	Page
A glance into the future	
maxCON	16
Cable Connectors:	
XX Series.....	18
EMC-XLR Series.....	18
RX Series.....	19
XX-HE Series.....	19
XX-14 Series.....	20
XX Crimp Series.....	20
crystalCON.....	21
convertCON.....	21
XX-HD Series.....	22
X Series.....	22
X-HD Series.....	23
XCC Series.....	23
FXS Series.....	24
FX-SPEC Series.....	24
8 + 2 pole XLR Type Data Power Connector	25
Technical Data.....	26
Ordering Information.....	28
Receptacles:	
A Series	30
AA Series	30
B Series	31
A / B Series - switch	32
D Series	32
DL Series	33
DLX Series	33
DLX Crimp Series	34
EMC Series	34
MPR-HD Series	35
P Series	35
Combo Series.....	36
Combo A Series	37
Accessories	38
Technical Data	39
Ordering Information A / AA Series	41
Ordering Information B Series	42
Ordering Information D / DL / DLX / DLX Crimp	42
Ordering Information EMC / P / MPR-HD	43
Ordering Information Combo / Combo A Series.....	43
Panel Cutouts, Assembly Tools	43

NEUTRIK®, **crystalCON®**, **etherCON®**, **maxCON®**, **miniCON®**, **nanoCON®**, **neutriCON®**, **opticalCON®**, **powerCON®**, **Profi®**, **rearTWIST®**, **silentPLUG®**, **speakON®**, **DIWA®**, **XIRIUM®**, are registered trademarks of Neutrik AG.



Introduction

Neutrik XLR connectors are the most well known series of products manufactured by Neutrik, and have provided the professional audio industry a simple, yet striking, concept in connector features. We introduced our first XLR product 40 years ago. Today it is the accepted standard worldwide.

XLR connectors are part of almost every aspect of professional audio; as a microphone connector, in lighting systems, and found in almost any piece of sound equipment in the entertainment industry. The outstanding success of our XLR products is Neutrik's blend of innovation with the highest quality performance.

A glance into the future: maxCON® – the new XLR standard

Neutrik's success story began with the construction of the first prototype of a new XLR female cable connector.

The first NC3FC products were delivered in October 1975. During the years 1976, 1977 and 1978 this product range was continuously reworked and improved. In 1983 a new concept was introduced with the X series that has become a world standard.

The further development of the X series leading to the XX series with the unique protection against copying, the hologram, is based on this hundred million times sold X series.

The next generation of audio connectors – maxCON® – will offer unique features and benefits based on the small and innovative design.

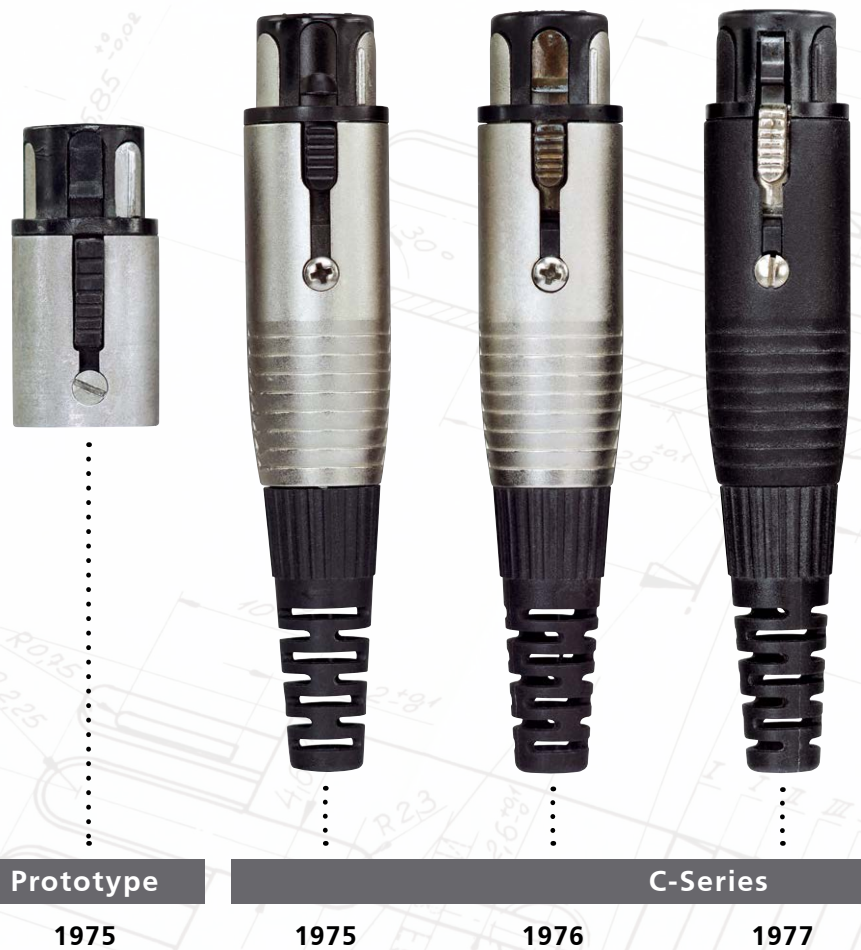

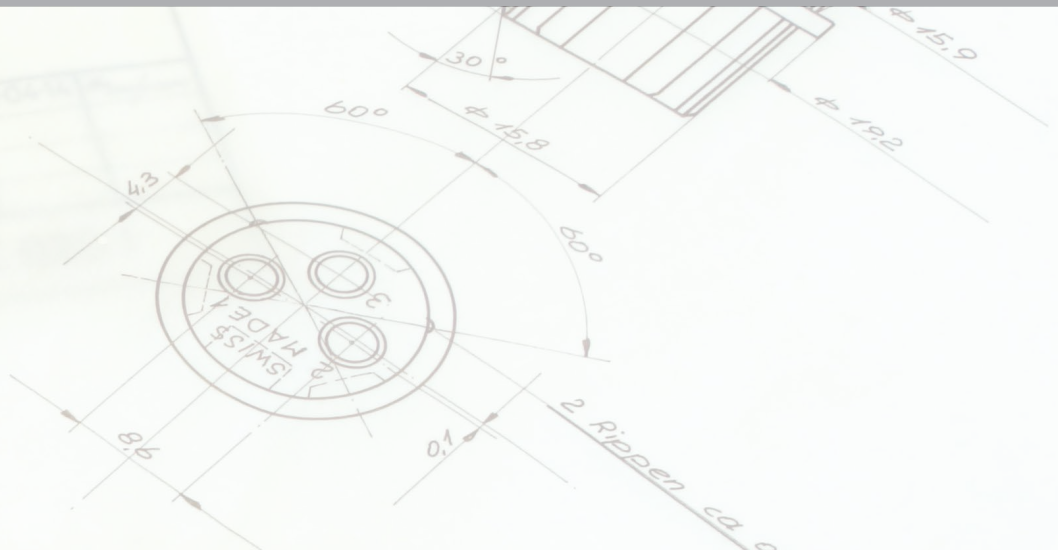

1978



X-Series

1983



XX-Series

2004



maxCON®

A glance into the future.

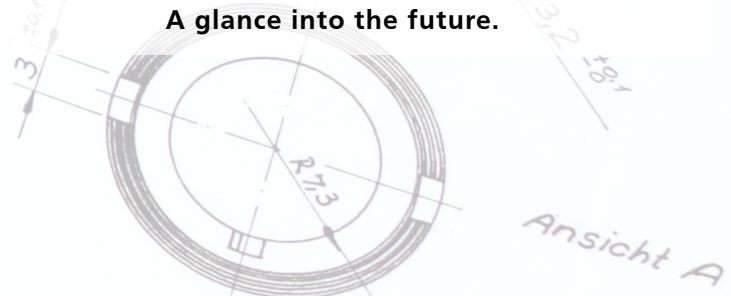

XLR Cable Connectors



Ergonomic latch design



White painted housing



Circumferential ground shield contact



Neutrik hologram

XX Series

EMC-XLR Series



NC3FXX



NC6MXX-B



NC3FXX-EMC



NC3MXX-EMC

- The next generation of the worldwide accepted standard
- Unique cage type female contact – increases conductivity
- Female contact with “solder stop” for ease of soldering
- Male connector without locking “window” – more robust housing, increases durability
- Improved chuck type strain relief - increases retention force and makes assembly easier and faster
- New ground contact – excellent contact integrity between chassis and cable connector
- Customized branding using translucent ring
- Sleek and ergonomic design – valuable and handy
- Unique hologram – guarantees genuineness and protects against counterfeits
- Internal thread on shell is well protected against any damage

- 3 pole male / female XLR cable connector with integrated capacitive shield to shell connection to avoid RF-interference and LF-noise
- 360° shield contact on female connector ensures best possible shielding and chassis contact
- Avoid ground loops as there is no LF-shield connection to ground
- Patented

NC*FXX

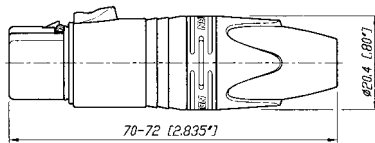

NC*MXX

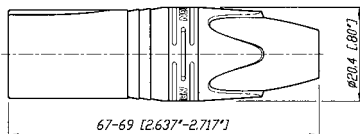

*: 3 - 7 contacts

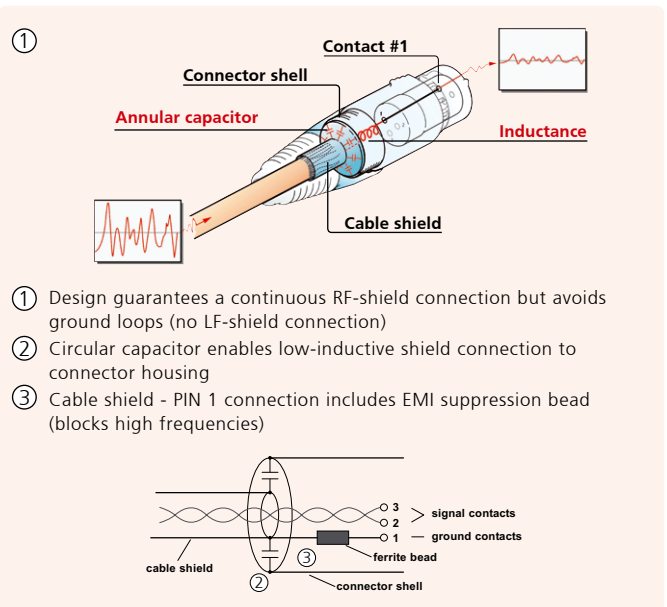



Right angle male connector



High temperature resistant insulator



Velour chromium housing

RX Series



NC3FRX-BAG

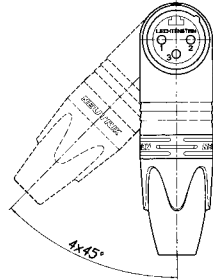

Outlet position

- Right angle version of the XX Series – only 20 mm wide
- Extra slim right-angle connector
- Neutrik chuck type strain relief
- 5 selectable cable outlet positions on female & 7 position on male connectors

XX-HE Series



NC3FXX-HE



NC3MXX-HE

- Exclusive "High End" version of standard XX Series
- Premium velour chromium plating provides soft satin finish
- Extra high temperature resistant insulator material rated to 280 °C (536 °F)
- Machined female contacts standard
- Insert is dark grey to distinguish it from standard XX-Series insulators
- Flammability UL 94V-0

NC*FRX

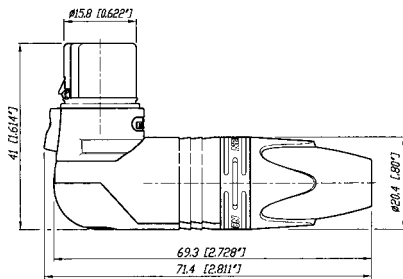

NC*MRX

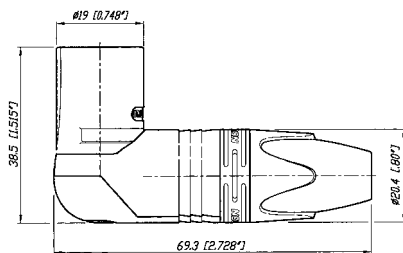

*: 3 - 7 contacts

NC3FXX-HE

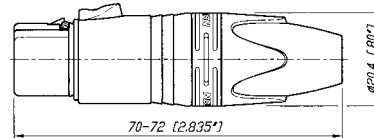

NC3MXX-HE

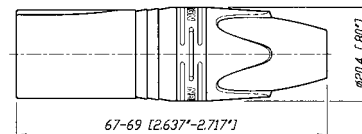



Large cable outlet



Ergonomic latch design



Neutrik hologram design



XX-14 Series



NC3FXX-14



NC3MXX-14-B

- Special version of the XX Series XLR cable connector for large diameter cables
- Incorporates all the features of the XX product series
- Rear boot features large opening for use with cable O.D. 8.0 – 10.0 mm
- Bulk packed; must be ordered in multiples of 100

XX Crimp Series



NC3FXX-HA-BAG



NC3MXX-HA

- 3 pin XX Series with crimp contacts
- Accommodates wire size AWG 24 - 22 or 0.22 – 0.34 mm²
- Utilize standard B-type crimp tool (acc. IEC 60352-2)
- Absolute leadfree and solderless connection:
 - RoHs compliance
 - health and eco-friendly
- Fast and easy assembly
- Gas-tight connection offers a constant contact resistance
- Ideal solution for field and on-site termination

NC3FXX-14

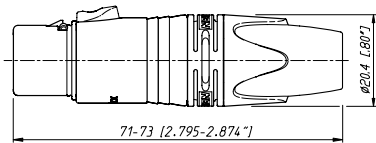

NC3FXX-HA

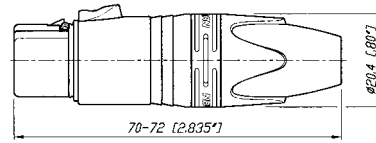

NC3MXX-14

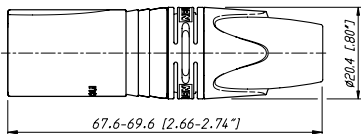

NC3MXX-HA

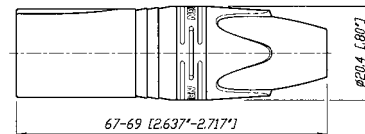



CRYSTALLIZED™ – Swarovski Elements



convertCON position male – female

crystalCON



NC3FXX-B-CRYSTAL



NC3MXX-B-CRYSTAL

- 3 pole XLR XX-Series embellished with CRYSTALLIZED™ – Swarovski Elements
- Exclusively with gold plated contacts, and black chrome housing
- Fancy, noble, valuable, attractive package – an eye-catcher
- With all benefits of the XLR XX-Series

convertCON



NC3FM-C-B



NC3FM-C

- World's first Unisex XLR cable connector
- 3 pole male and female cable connector in one housing
- Easy selectable gender – converted by sliding housing back and forth
- Substitutes adapters, ideal as an emergency kit
- Exclusively with gold plated contacts
- With all benefits of the XLR XX-Series



Convert
male – female
and vice versa

NC3FXX-B-CRYSTAL

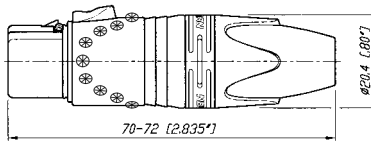

NC3MXX-B-CRYSTAL

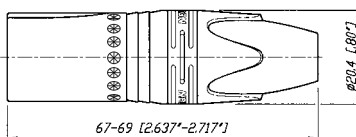

NC3FM-C: Position Female

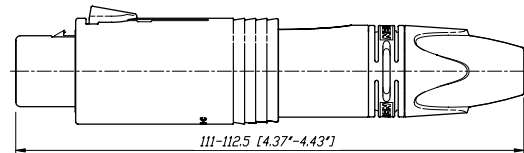

NC3FM-C: Position Male

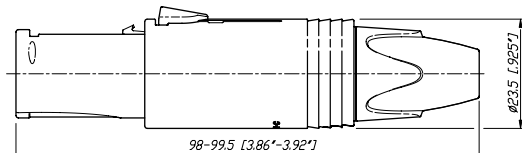



Rubber sealing protection



Neutrik original design

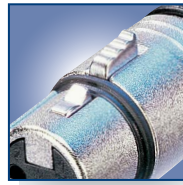

Female locking

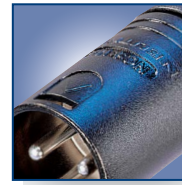

Male metal locking window



XX-HD Series



NC3FXX-HD-D

NC3MXX-HD-B-D

- "Heavy duty" cable connector for outdoor use
- Rubber sealing jacket protects against water ingress and mechanical shock
- Dust and water resistant according to IP 67 in the following combinations:
 - NC3FXX-HD and NC3MPR-HD
 - NC3FXX-HD and NC3MXX-HD
- Gold contacts
- Chuck type strain relief system for secure clamping of cables
- Rugged zinc diecast shell, longlasting and dependable

NC3FXX-HD-D

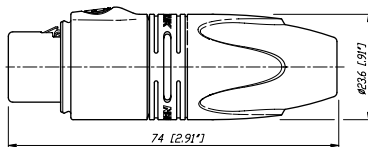

NC3MXX-HD-D

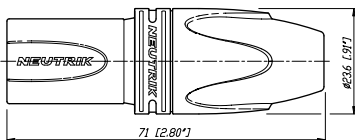

X Series



NC3FX

NC3MX + BSX-5

- The XLR connector standard worldwide
- Available in 3 – 7 pin configurations including 6 pin Switchcraft® configuration
- Assembly is quick and easy – no screws or special tools required
- Unique Neutrik chuck type internal strain relief
- Female shell features rubber ring for secure mating to male XLR or microphone
- Sleek profile and compact design
- Rugged diecast shell
- UL recognized components

NC*FX

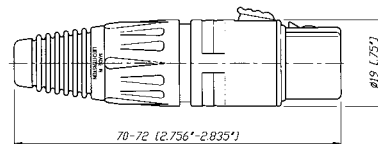

NC*MX

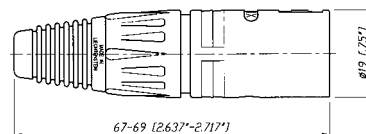

*: 3 - 7 contacts



Rubber sealing protection



Metal bushing



Coding ring

X-HD Series

XCC Series



NC5FX-HD



NC4MX-HD



NC3FXCC

- "Heavy duty" cable connectors for outdoor use
- All metal design, male stainless steel
- NC*FX-HD mates with NC*MPR-HD chassis connector and NC*MX-HD
- Dust and water resistant according IP 65 in mated condition
- Available in 3 – 5 pin configuration
- Metal bushing including O-ring

- Coaxial ground spring and hex crimp ferrule at cable entrance allow continuous (360°) ground connection to shell which is essential when transmitting low level audio signals
- Includes Zebra coding ring to indicate digital AES signals
- Ground contact uses 6.5 mm (.255") size "E" hex crimp (IEC 60803). Use part # HX-R-BNC with DIE-R-BNC-PT

NC*FX-HD

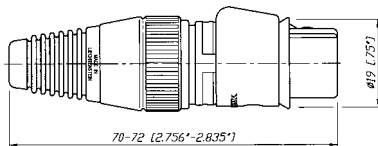

NC3FXCC

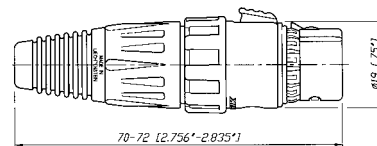

NC*MX-HD

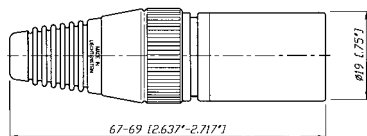

NC3MXCC

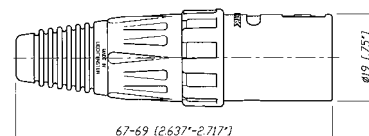

*: 3 - 5 contacts



Switch activating ring



Locking ring

FXS Series



NC3FXS

NC3FXS-B

- Available exclusively in a 3 pin female configuration
- Features a noiseless ON/OFF switch which shorts pins 2 and 3 together muting the signal voltage between conductors
- For use with a microphone that does not have its own On / Off switch
- Rugged zinc diecast shell, long lasting and durable
- Chuck type strain relief system for secure clamping of cables
- Boot with rubber gland gives high protection against bending stresses

NC3FXS

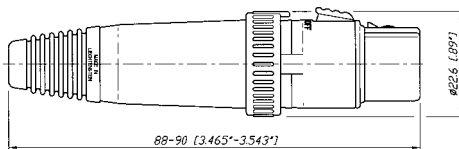

FX-SPEC Series



NC3FX-SPEC.

- Available in a 3 pin female standard configuration with gold plated contacts
- Features a locking ring which is secured with a M 2.5 screw and 1.27 mm allen wrench
- Offers the highest security protection for your microphones
- Protects against accidental disconnects and theft
- Black chrome housing and locking ring
- Eliminates movements and noises

NC3FX-SPEC.

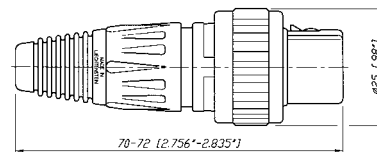



NEW 8 + 2 pole cable connector



Ergonomic latch design



New 8 + 2 pole D-size receptacle



Solder termination

XLR Type Data Power Connectors – 8 + 2 pole



NC10FXX-14-B



NC10FRX-14-B



NC10MD-LX-B

- Suitable for data offering CAT 5e performance and power up to 16 A and 50 V - exceeds PoE+ capabilities
- Superior ruggedness compared to RJ45 type connectors
- All metal housing offers best overall RF protection and electromagnetic shielding
- D-size housing provides installation compatibility with industry standard D mounting dimensions
- Receptacle with duplex ground contact for excellent signal integrity

8 + 2 pole Contact Arrangements:

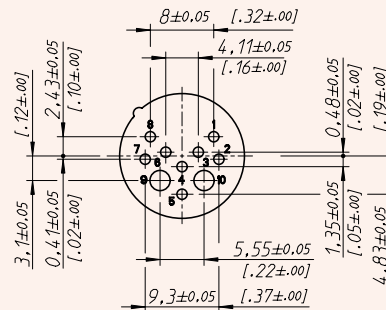

NC10FXX-14-B

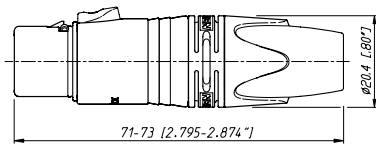

NC10MXX-14-B

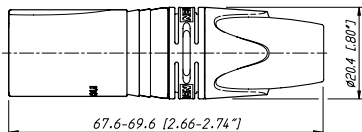

NC10FD-LX-B

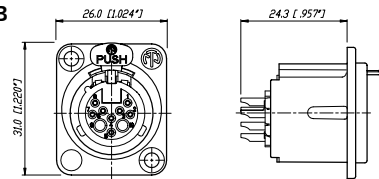

NC10MD-LX-B

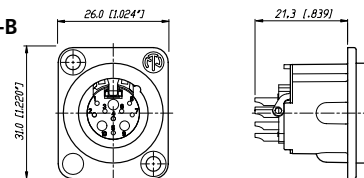

Specification	XX & XX-14 & CRYSTAL	EMC Series	XX-HD Series	XX-HE Series	RX Series	XX Crimp Series	convert-CON Series
Electrical							
Number of contacts	3 - 7 ¹⁾	3	3	3	3 - 7	3	3
Contact resistance	≤ 3 mΩ	●	●	●	●	●	●
Insulation resistance - initial:	> 10 GΩ	●	●	●	●	●	●
- after damp heat test:	> 1 GΩ	●	●	●	●	●	●
Dielectric strength	1.5 kV dc	●	●	●	●	●	●
Cable shield-shell connection	choosable	●	-	●	●	●	●
	determined	-	capacitive	-	-	-	-
Shielding effectiveness	> 55 dB @ 1.3 GHz	-	●	-	-	-	-
Lossy ferrite bead on PIN 1		-	●	-	-	-	-
Rated current per contact	@ 35°C						
3 pole:	16 A	●	5 A	●	●	1 A	●
4 pole:	10 A	●	-	-	-	-	-
5, 6 pole:	7.5 A	●	-	-	-	-	-
7 pole:	5 A	●	-	-	-	-	-
Capacitance between contacts							
3 pole:	≤ 4 pF	●	●	●	●	●	●
4, 5, 6 pole:	≤ 7 pF	●	-	-	-	-	-
7 pole:	≤ 9 pF	●	-	-	-	-	-
Rated Voltage	< 50 V ac	●	●	●	●	●	●
Mechanical							
Lifetime	> 1'000 cycles	●	●	●	●	●	●
Insertion / withdrawal force	≤ 20 N	●	≤ 50 N	●	●	●	●
Cable O.D. range	3.5 - 8.0 mm	● ²⁾	●	6.0 - 8.0 mm	●	●	●
Max. wire size	3 pole: 2.5 mm ² / AWG 14	●	AWG 20	●	●	-	●
	4 pole: 1.5 mm ² / AWG 16	●	-	-	-	-	-
	5, 6, 7 pole: 1.0 mm ² / AWG 18	●	-	-	-	-	-
Crimp tool:	6.5 mm Hex die (size "E" acc. to IEC 60352-2)	-	-	-	-	●	-
Crimp XX:	0.22 - 0.34 mm ² / AWG 24 - 22	-	-	-	-	●	-
Material							
Shell	Zinc diecast (ZnAl4Cu1)	●	●	-	●	●	●
	Stainless steel	-	-	-	-	-	-
Shell plating	gal Ni or black Cr	●	●	-	velour Cr	●	●
Insert	Polyamide PA 6.6 30% GR	●	●	●	PPS 40% GR	●	●
Contacts - female 3 pole:	Bronze (CuSn8)	●	●	●	Brass	●	●
- female 4 – 7 pole & male:	Brass (CuZn39Pb3)	●	●	●	●	-	●
Contact surface	Silver gal 2 μm Ag	●	-	-	-	●	●
	or Gold gal 0.2 μm Au hard alloy over 2 μm Ni	●	●	●	●	●	●
Latch lock	St3K32 (latch) / Ck 67 (spring)	-	-	-	-	-	-
	Zinc diecast (ZnAl4Cu1) / CK67 (Spring)	●	●	●	●	●	●
Strain-relief clamp	POM	●	●	●	●	●	●
Bushing	PA / PU	●	●	●	●	●	●
Circumferential ground spring	Bronze (CuSn6), Ni plated	-	●	-	-	-	-
Crimp ferrule	Brass (CuZn39Pb3), Ni plated	-	-	-	-	-	-
Coding ring	Polyamide PA 6 15% GR	-	-	-	-	-	-
Sealing jacket	EPDM	-	-	●	-	-	-
Securing ring	Brass (CuZn39Pb3)	-	-	-	-	-	-
Environmental							
Operating temperature	-30 °C to +80 °C	●	●	●	●	●	●
Flammability	UL 94 HB	●	●	●	V-0	●	●
Protection class	IP 40	●	●	IP 67	●	●	●
Solderability complies with	IEC 68-2-20	●	●	●	●	●	●
Manufacturing Standard	IEC 61076-2-103	●	●	●	●	●	●

¹⁾: XX-14, CRYSTAL: 3 pole

²⁾: XX-14: Cable O.D. 8.0 – 10.0 mm

Specification		X Series	XCC Series	X-HD Series	FXS Series	FX-SPEC Series	Data Power XLR
Electrical							
Number of contacts		3 - 7	3	3 - 5	3	3	8 + 2
Contact resistance	≤ 3 mΩ	●	●	●	●	●	●
Insulation resistance	- initial: > 10 GΩ	●	●	●	●	●	●
	- after damp heat test: > 1 GΩ	●	●	●	●	●	0.1 GΩ
Dielectric strength	1.5 kV dc	●	●	●	●	●	1 kV dc
Cable shield-shell connection	choosable	●	-	●	-	●	●
	determined	-	crimp	-	-	-	-
Shielding effectiveness	> 55 dB @ 1.3 GHz	-	●	-	-	-	-
Lossy ferrite bead on PIN 1		-	-	-	-	-	-
Rated current per contact	@ 35°C						16 A (power pins)
	3 pole: 16 A	●	●	●	●	●	-
	4 pole: 10 A	●	-	●	-	-	-
	5, 6 pole: 7.5 A	●	-	●	-	-	-
	7 pole: 5 A	●	-	-	-	-	3 A (data pins)
Capacitance between contacts							
	3 pole: ≤ 4 pF	●	●	●	●	●	-
	4, 5, 6 pole: ≤ 7 pF	●	-	●	-	-	-
	7 pole: ≤ 9 pF	●	-	-	-	-	-
Rated Voltage	< 50 V ac	●	●	●	●	●	-
Transmission Performance	CAT 5e	-	-	-	-	-	●
Mechanical							
Lifetime > 1'000 cycles		●	●	●	●	●	●
Insertion / withdrawal force	≤ 20 N	●	●	●	●	●	●
Cable O.D. range	3.5 – 8.0 mm	●	5.4 - 6.2 mm	●	3.5 - 7.0 mm	●	8.0 - 10.0 mm
Max. wire size	3 pole: 2.5 mm ² / AWG 14	●	●	●	●	●	● (2 power)
	4 pole: 1.5 mm ² / AWG 16	●	-	●	-	●	-
	5, 6, 7 pole: 1.0 mm ² / AWG 18	●	-	●	-	-	● (8 data)
Crimp tool:	6.5 mm Hex die (size "E" acc. to IEC 60803)	-	●	-	-	-	-
Crimp XX:	0.22 - 0.34 mm ² / AWG 24 - 22	-	-	-	-	-	-
Material							
Shell	Zinc diecast (ZnAl4Cu1)	●	●	female	●	●	●
	Stainless steel	-	-	male	-	-	-
Shell plating	gal Ni or black Cr	-	●	female	●	●	black Cr
Insert	Polyamide PA 6.6 30% GR	●	●	●	●	●	●
Contacts	- female 3 pole: Bronze (CuSn8)	●	●	●	●	●	-
	- female 4 – 7 pole & male: Brass (CuZn39Pb3)	●	●	●	-	-	●
Contact surface	Silver gal 2 μm Ag	●	-	-	●	-	-
	or Gold gal 0.2 μm Au hard alloy over 2 μm Ni	-	●	●	-	●	●
Latch lock	St3K32 (latch) / Ck 67 (spring)	●	●	●	●	●	-
	Zinc diecast (ZnAl4Cu1)	-	-	-	-	-	●
Strain-relief clamp	POM	●	●	●	●	●	●
Bushing	PA / PU	●	●	SS/PU	PU	●	●
Circumferential ground spring	Bronze (CuSn6), Ni plated	-	●	-	-	-	-
Crimp ferrule	Brass (CuZn39Pb3), Ni plated	-	●	-	-	-	-
Coding ring	Polyamide PA 6 15% GR	-	●	-	-	-	-
Sealing jacket	EPDM	-	-	●	-	-	-
Securing ring	Brass (CuZn39Pb3)	-	-	-	-	●	-
Environmental							
Operating temperature	-30 °C to +80 °C	●	●	●	●	●	●
Flammability	UL 94 HB	●	●	●	●	●	●
Protection class	IP 40	●	●	IP 65	●	●	●
Solderability complies with	IEC 68-2-20	●	●	●	●	●	●
Manufacturing Standard	IEC 61076-2-103	●	●	●	●	●	●

Ordering Information for Cable Connectors

Female	Male	Shell	Contact - plating	3 pole	4 pole	5 pole	6 pole	7 pole
XX Series								
NC*FXX	NC*MXX	Nickel	Silver	●	●	●	●	●
NC*FXX-B	NC*MXX-B	Black Cr	Gold	●	●	●	●	●
NC*FXX-BAG	NC*MXX-BAG	Black Cr	Silver	●	●	●	●	●
NC3FXX-WT	NC3MXX-WT	White painted	Silver	●	-	-	-	-
NC3FXX-**-D ¹	NC3MXX-**-D ¹	Nickel / Black Cr	Silver / Gold	●	-	-	-	-
NC6FSXX ²	NC6MSXX ²	Nickel	Silver	-	-	-	●	-
NC6FSXX-B ²	NC6MSXX-B ²	Black Cr	Gold	-	-	-	●	-
NC6FSXX-BAG ²	NC6MSXX-BAG ²	Black Cr	Silver	-	-	-	●	-
XX-EMC Series								
NC3FXX-EMC	NC3MXX-EMC	Nickel	Gold	●	-	-	-	-
NC3FXX-EMC-B	-	Black Cr	Gold	●	-	-	-	-
RX Series								
NC*FRX	NC*MRX	Nickel	Silver	●	●	●	●	●
NC*FRX-B	NC*MRX-B	Black Cr	Gold	●	●	●	●	●
NC*FRX-BAG	NC*MRX-BAG	Black Cr	Silver	●	●	●	●	●
XX-HE Series								
NC3FXX-HE	NC3MXX-HE	Velour Chromium	Gold	●	-	-	-	-
XX-14 Series								
NC3FXX-14-D	NC3MXX-14-D	Nickel	Silver	●	-	-	-	-
NC3FXX-14-B-D	NC3MXX-14-B-D	Black Cr	Gold	●	-	-	-	-
NC3FXX-14-BAG-D	NC3MXX-14-BAG-D	Black Cr	Silver	●	-	-	-	-
XX Crimp Series								
NC3FXX-HA	NC3MXX-HA	Nickel	Silver	●	-	-	-	-
NC3FXX-HA-BAG	NC3MXX-HA-BAG	Black Cr	Silver	●	-	-	-	-
convertCON Series								
	NC3FM-C	Nickel	Gold	●	-	-	-	-
	NC3FM-C-B	Black Cr	Gold	●	-	-	-	-
Crystal XLR								
NC3FXX-B-CRYSTAL	NC3MXX-B-CRYSTAL	Black Cr	Gold	●	-	-	-	-
XX-HD Series								
NC3FXX-HD-D	NC3MXX-HD-D	Nickel	Gold	●	-	-	-	-
NC3FXX-HD-B-D	NC3MXX-HD-B-D	Metal Black	Gold	●	-	-	-	-

Ordering Information for Cable Connectors

Female	Male	Shell	Contact - plating	3 pole	4 pole	5 pole	6 pole	7 pole
X Series								
NC*FX	NC*MX	Nickel	Silver	●	●	●	●	●
NC*FX-B	NC*MX-B	Black Cr	Gold	●	●	●	●	●
NC*FX-BAG	NC*MX-BAG	Black Cr	Silver	●	●	●	●	●
NC3FX-**-D ¹	NC3MX-**-D ¹	Nickel / Black Cr	Silver / Gold	●	-	-	-	-
NC6FSX ²	NC6MSX ²	Nickel	Silver	-	-	-	●	-
NC6FSX-B ²	NC6MSX-B ²	Black Cr	Gold	-	-	-	●	-
NC6FSX-BAG ²	NC6MSX-BAG ²	Black Cr	Silver	-	-	-	●	-
X-HD Series								
NC*FX-HD	NC*MX-HD	Nickel	Gold	●	●	●	-	-
NC3FX-HD-B	NC3MX-HD-B	Metal Black	Gold	●	-	-	-	-
XCC Series								
NC3FXCC	NC3MXCC	Nickel	Gold	●	-	-	-	-
FXS Series								
NC3FXS	-	Nickel	Gold	●	-	-	-	-
NC3FXS-B	-	Black Cr	Gold	●	-	-	-	-
FX-SPEC. Series								
NC3FX-SPEC.	-	Black Cr	Gold	●	-	-	-	-

Ordering Information for 8 + 2 pole Data Power Connectors

Female	Male	Shell	Contact - plating	8 + 2 pole
Cable Connector				
NC10FXX-14-B	NC10MXX-14-B	Black Cr	Gold	●
NC10FRX-14-B	NC10MRX-14-B	Black Cr	Gold	●
Receptacle				
NC10FD-LX-B	NC10MD-LX-B	Black Cr	Gold	●

Accessories and Assembly Tools

Detailed information on page 38 and 43.

* : Number of Contacts

** : Nickel or Black

-D¹: Bulk packed, to be ordered in multiples of 100 pcs.

²: Switchcraft Equivalent



Smallest receptacle

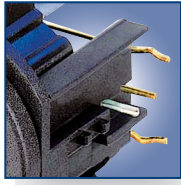

Lateral right PCB mount

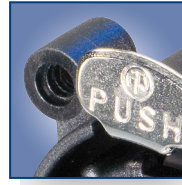

Locking release tab



Ground contact



NEW: Ergonomic asymmetric locking release tab

A Series



NC3FAH



NC3MAV

- Smallest XLR receptacles, highest packing density
- Plastic housing
- Various grounding options
- "Tulip" type female contact design with high contact pressure
- Selective gold plated contact and PCB termination area for best conductivity and solderability
- Plastic housing flammability UL 94V-0 for 3 pole version only

AA Series



NC3FAAV2



NC3MAAH-1

- Front panel cutout and PCB layout 100% compatible to the A Series
- Most cost-effective series
- "Tulip" type female contact design with high contact pressure
- Selective gold plated contact and PCB termination area for best conductivity and solderability
- Plastic housing flammability UL 94 HB

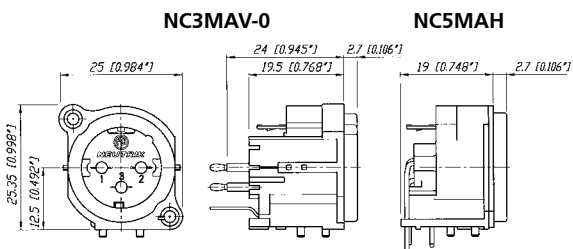
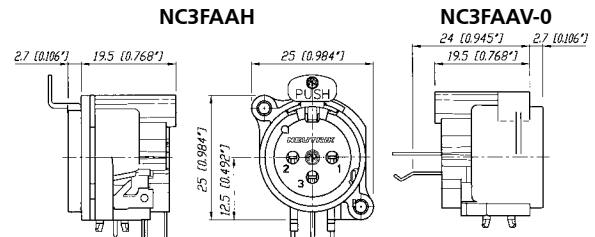
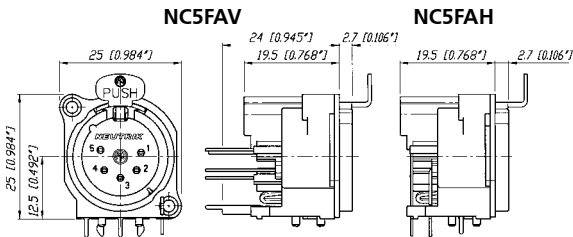

Grounding Options (A / AA / B Series):

Female:

- 1: Pin 1 & Panel & Shell connected, no separate ground contact
- 2: Separate ground contact connected to shell & panel, separate Pin 1 w/o number: No ground / Shell contact (except 4 / 5 pole)

Male:

- 0: Separate ground contact, connected to shell, separate Pin 1
- 1: Pin 1 & Panel & Shell connected, no separate ground contact w/o number: Separate ground contact connected to shell & panel, separate Pin 1



Circumferential metal ring



Front panel grounding



Tear drop contact design



NEW: Ergonomic asymmetric locking release tab



B Series



NC3FBV1



NC3MBV



NC4FBH



NC4MBV

- The B Series XLR receptacle offers the same features as our A Series product line with the added feature of a metal ring
- Metal ring on shell (nickel or black) offers complete EMC and RF protection
- Female versions available latchless
- Rear mount only
- "Tulip" type female contact
- Plastic housing flammability UL 94V-0 for 3 pole version only

NC3FBV1

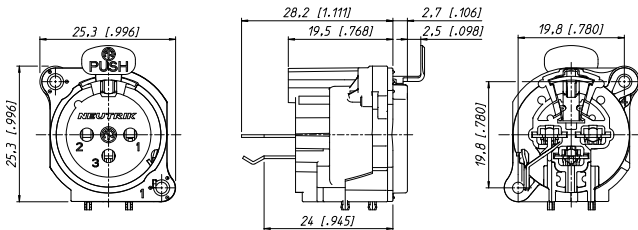

NC3MBV

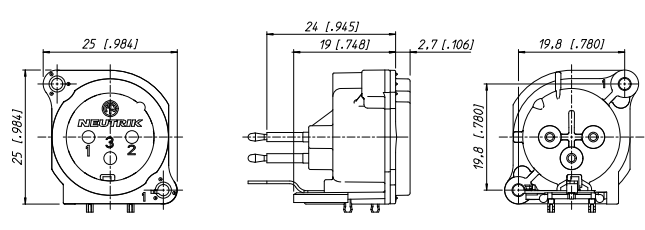



Incorporated switch

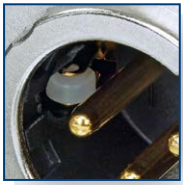

Insert removable



A/B Series - Switch

D Series



NC3FBV2-SW



NC3MBV-SW



NC3FDM3-H-B



NC3MD-V

- A and B Series connector with additional switch
- Normally open, normally closed (NO – NC) contact
- Switch activated by mating XLR cable connector

- "D" Shape metal shell
- Optimal RF protection using 3 shield contacts
- Horizontal and vertical PCB mount with separate ground contact
- Mounting holes with M3 threads available
- 2 piece connector, insert is removable from shell
- Front locked / unlocked insert
- Special version with screw termination (*M3)

Inserting (Schematic):

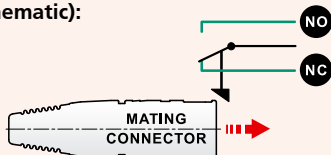

NC5FAV-SW

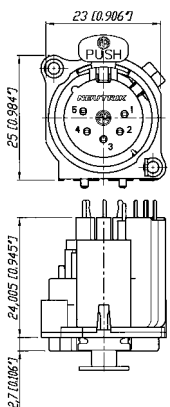

NC5MBV-SW

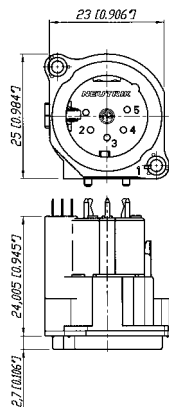

NC3FD-V / NC3FD-H

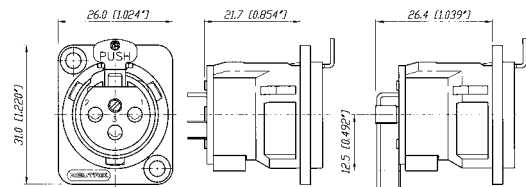

NC3MD-V / NC3MD-H

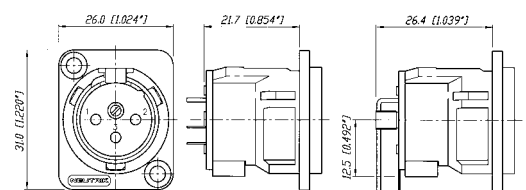



Locking release tab



Horizontal PCB mount



Ground shielding



White painted housing



DL Series

DLX Series



NC3FD-L-1



NC7MD-L-B-1



NC3FD-LX-HE



NC5MD-LX

- Unified "D" metal shell
- Solder cups on 3 – 7 pole version
- Additional PCB mount on 4 and 5 pole
- Front and rear mountable

- Next generation of the popular DL Series with greater functionality
- All metal housing works in combination with a new duplex ground contact yielding the best RF protection and ground conductivity in a chassis mount XLR
- Male connector's retention bar replaces plastic design with all metal version
- Unique cage type female contacts on 3 pole version for increased conductivity
- Machined male and female contacts on 4 - 7 pole versions
- D-style housing provides installation compatibility with industry standard D mounting dimensions

NC3FD-L-1

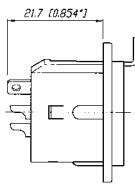
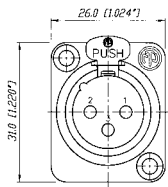

NC*FDM3-H

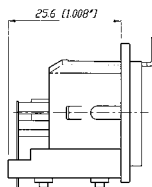

NC3MD-L-1

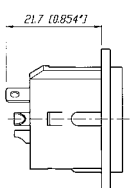
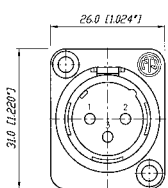

NC*MDM3-H

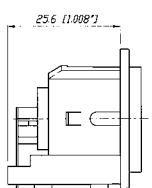

NC3FD-LX

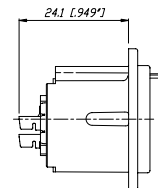
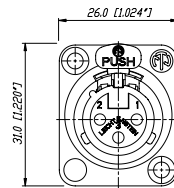

NC*MD-LX

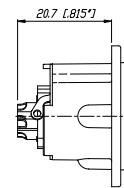

*: 3 - 5 contacts

*: 3 - 7 contacts



Crimp type contact



Circumferential ground spring

DLX Crimp Series



NC3FD-LX-HA



NC3MD-LX-BAG-HA

- 3 pole DLX Series with crimp contacts
- Accommodates wire size AWG 24 – 22 or 0.22 – 0.34 mm²
- Utilizes standard B-type crimp tool (acc. IEC 60352-2)
- Absolute leadfree and solderless connection:
 - RoHs compliance
 - Health and eco-friendly
- Fast and easy assembly
- Gas-tight connection offers a constant contact resistance
- Ideal solution for field and on-site termination

EMC Series



NC3FDX-EMC-SPEC

- 3 pole female XLR chassis connector with integrated capacitive shield to shell connection to avoid RF-interference and LF-noise
- 360° shield contact ensures best possible shielding and chassis contact
- D flange chassis for panel mount applications
- Includes the locking nut of the NC3FX-SPEC for secure fastening of a gooseneck for instance
- Special flange for large openings available
- Patent pending

Detailed information of RF-shielding see page 18 – EMC cable connector.

NC3FD-LX-HA

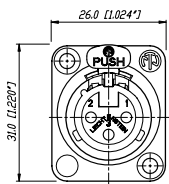

NC3MD-LX-HA

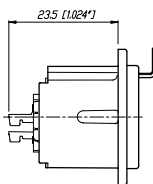

NC3FDX-EMC-SPEC

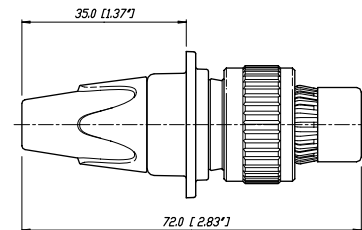
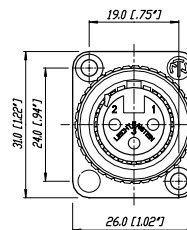



Sealing Gasket

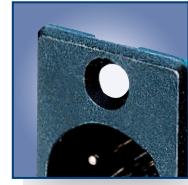

Through hole fastening

MPR-HD Series



NC3MPR-HD



NC5MPR-HD

- IP 65 – in combination with NC*FX-HD cable connectors
- Perfect for outdoor applications
- Sealing gasket for water tight panel mount
- Gold plated contacts



NC5MPR-HD

NC5FX-HD

NC3MPR-HD

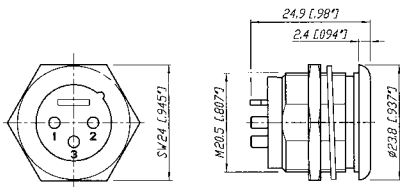

*: 3 - 5 contacts

P Series



NC3FP-1



NC6MP-B

- Male and female available in 3 – 6 pin configurations; 7 pin version available in female only
- Smallest available hard wiring receptacles with large solder cups
- Male and female use different mounting hole dimensions and do not fit in same mounting hole
- Front mountable only
- One piece version – insert is NOT removable from shell
- Short female receptacle
- Compatible with Switchcraft® DxM, DxP; Cannon XLRx31, XLRx32
- 6 pole female version available with Switchcraft contact arrangement

NC3FP-1

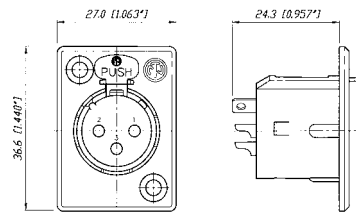

NC3MP

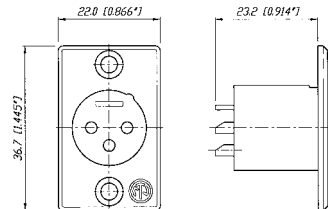



Front end design



Solder termination

Combo Series



NCJ9FI-V

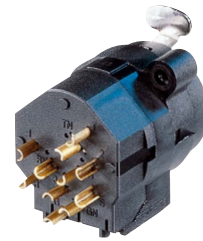

NCJ10FI-S

- Combined XLR receptacle and 1/4" phone jack
- Attractive "front end" design
- Saves rack space by combining 2 connectors in one housing
- Horizontal or vertical PCB mount or hard wire soldering
- Fully normalised
- Stereo or mono version

- Very low conductor capacitance, therefore suitable for digital audio
- Fastening: Self-tapping Plastite® screws with thread 2.9 x 1.06 and tri-rondular configuration (A screw)



NCJ10FI-H

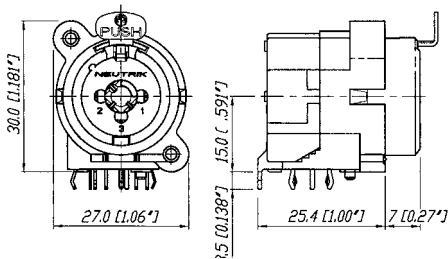

Wiring: Example of NCJ9FI-H

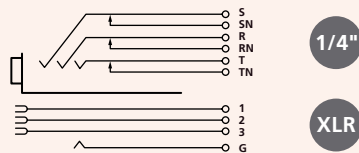



Hologram



Horizontal PCB mount



Vertical PCB mount



NEW: Ergonomic asymmetric locking release tab

Combo A Series



NCJ6FA-V-0



NCJ6FA-H

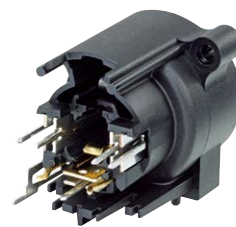

NCJ6FA-V-0

- Combined 3 pole XLR receptacle and 1/4" phone jack for balanced mic and line or instrument inputs in one XLR housing
- Dramatic space saving – 15 % over the predecessor Combo
- Two connectors in one housing – substantial cost, material and labour saving
- Horizontal and vertical PCB mount available
- 3 pole female XLR combined with stereo TRS jack
- Very low conductor capacitance – ideal for digital audio
- Front panel cut-out compatible with Neutrik XLR A Series
- Branded with unique hologram – guarantees genuine and authentic Neutrik product

NCJ6FA-V

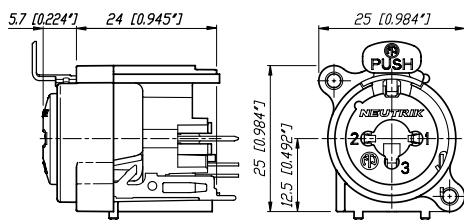

NCJ6FA-H

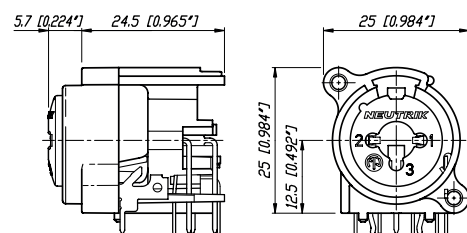

Colour Coded Accessories

Part No.	Description	Black 0	Brown 1	Red 2	Orange 3	Yellow 4	Green 5	Blue 6	Violet 7	Grey 8	White 9
----------	-------------	------------	------------	----------	-------------	-------------	------------	-----------	-------------	-----------	------------

XLR Cable Connectors

BSX-*	Colored bushing for X Series										
BXX-*	Colored bushing for XX Series										
XCR-*	Colored coding ring for X Series										
XXR-*	Colored coding ring for XX Series										

XLR Chassis Connectors

ACRF-*	Colored ring for female 4 pole A Series and 4 + 5 pole B Series.										
ACRM-*	Colored ring for male 4 pole A Series and 4 + 5 pole B Series										
DSS-*	Lettering plate for D Series										

Accessories

XLR Cable Connectors

BXX-CR	Bushing with translucent coding ring
BXX-14	Large bushing set (cable O.D. 8.5 mm)
XXCR	Translucent coding ring for XX Series
	Label Dimensions: 57.9 mm x 6.35 mm – 2.25" W x 0.25" H)

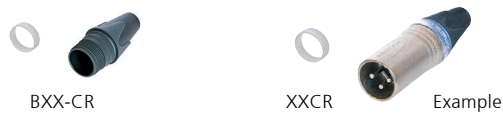

XLR Chassis Connectors

A-Screw-1-8	Plastite® screw 2.9 x 8
B-Screw-1-8	TAPTITE® screw 2.5 x 8
DBA	Dummy-plate for D Series panel cut outs
FDR1	Round panel mounting flange for NC3FDX-EMC-SPEC
HA-3FXX	Set of 50 female spare contacts for crimp XLR
HA-3MXX	Set of 50 male spare contacts for crimp XLR
MFD	M3 mounting frame for D-size chassis
ND*	dummyPLUG for female / male XLR chassis connector
NZP1RU-8	Panel 1RU with 8 D-shape housing cutouts
NZP1RU-12	Panel 1RU with 12 D-shape housing cutouts
SC*	Rubber sealing cap for female and male XLR receptacles
PUSH-ASYM	Asymmetric push for A/AA/B & Combo A Series
SCDP-*	D Size sealing gaskets, color coding (*: 0- black, 2- red, 4- yellow, 5- green, 6- blue, 9- white)
SCDR	Rear end protection cover for D size chassis connectors
SCDX	Hinged cover seals D-size chassis connectors, IP42 rated
SCCD-W	Spring-loaded cover to seals D size chassis connectors, IP65 rated
SFAV	Rubber frame for A / B Series to mount between front plate and rear vertical print



Specification	A Series	AA Series	B Series	D Series	DL / DLX Series	DLX Crimp	DLX-HE Series
---------------	----------	-----------	----------	----------	-----------------	-----------	---------------

Electrical

Number of contacts	3 - 5	3	3 - 5	3	3 - 7	3	3
Contact resistance	≤ 6 mΩ	●	●	●	●	●	●
Insulation resistance - initial:	> 10 GΩ	●	●	●	●	●	●
- after damp heat test:	> 1 GΩ	●	●	●	●	●	●
Dielectric strength	1.5 kV dc	●	●	●	●	●	●
Rated voltage	< 50 V ac	●	●	●	●	●	●
Rated current per contact							
3 pole: 6 A	●	●	●	●	16 A	1 A	16 A
4 pole: 6 A	●	-	●	-	10 A	-	-
5, 6 pole: 3 A	●	-	●	-	7.5 A	-	-
7 pole: 5 A	-	-	-	-	●	-	-
Combo XLR + Jack contact	7.5 A	-	-	-	-	-	-
Capacitance between contacts							
3 pole: ≤ 4 pF	●	●	●	-	≤ 4 pF	≤ 4 pF	≤ 4 pF
4, 5, 6 pole: ≤ 7 pF	●	-	●	-	●	-	-
7 pole: ≤ 9 pF	-	-	-	-	●	-	-

Mechanical

Lifetime	> 1'000 mating cycles	●	●	●	●	●	●
Insertion / withdrawal force	≤ 20 N	●	●	●	●	●	●
Retention method							
- standard:	latch lock	●	●	●	●	●	●
- "0" Version:	≥ 20 N separating force	●	●	●	●	-	-
Crimp XX:	0.22 - 0.34 mm ² / AWG 24 - 22	-	-	-	-	●	-

Material

Insert	Polyamide PA 6.6 30% GR	●	●	●	●	●	PSS 40% GR
Shell	Zinc diecast ZnAl4Cu1	-	-	-	●	●	●
Shell plating	gal Ni or black Cr	-	-	●	●	●	velour Cr
Ring	Zinc diecast ZnAl4Cu1	-	-	●	-	-	-
Contacts	- female 3 pole: Bronze CuSn6	●	●	●	●	●	●
	4 - 5 pole: Bronze CuSn6	●	-	-	-	-	-
	4 - 7 pole: Brass CuZn39Pb3	-	-	-	-	●	-
	- male: Brass CuZn35Pb2	●	●	●	●	●	●
Contact surface	gal 0.2 μm AuCo over 2 μm NiP15 (Tribor®)	●	●	●	-	-	●
	gal 2 μm Ag or gal 0.2 μm Au hard alloy over 2 μm Ni	-	-	-	●	●	-
Latch lock & spring	Ck 67 steel, treated	●	●	●	●	●	●

Environmental

Operating temperature	-30 °C to +80 °C	●	●	●	●	●	●
Protection class	IP 40	●	●	●	●	●	●
Flammability	UL 94 HB	●	●	●	●	●	-
	UL 94 V-0	3 pole	-	3 pole	-	-	●
Solderability complies with	IEC 68-2-20	●	●	●	●	●	●
Mounting screw		A	A	1)	-	-	-
Color coding		ACR* 2)	-	ACR* 2)	DSS	DSS	DSS
	(4 + 5 pole only)						

1) : B Series 3 pole connectors > B-screw, 4 & 5 pole versions > A-screw
 2) : 4 + 5 pole A series, 5 pole B series

Specification	MPR-HD Series	P Series	Combo Series	A Combo
---------------	---------------	----------	--------------	---------

Electrical

Number of contacts		3-5	3-7 (6*)	5-10	3/3
Contact resistance	XLR: $\leq 6 \text{ m}\Omega$	●	●	$\leq 10 \text{ m}\Omega$	$\leq 10 \text{ m}\Omega$
	1/4" & switching contacts**: $\leq 20 \text{ m}\Omega$	-	-	●	$\leq 10 \text{ m}\Omega$
Insulation resistance	- initial: $> 10 \text{ G}\Omega$	●	●	●	●
	- after damp heat test: $> 1 \text{ G}\Omega$	●	●	$> 500 \text{ m}\Omega$	●
Dielectric strength	1.5 kV dc	●	●	●	●
Rated voltage	50 V ac	●	●	●	●
Rated current per contact					
	3 pole: 6 A	16 A	16 A	-	3 A
	4 pole: 6 A	10 A	10 A	-	-
	5, 6 pole: 3 A	7.5 A	7.5 A	-	-
	7 pole: 5 A	-	●	-	-
Combo XLR + Jack contact	7.5 A	-	-	●	●
Capacitance between contacts					
	3 pole: $\leq 7 \text{ pF}$	$\leq 4 \text{ pF}$	$\leq 4 \text{ pF}$	$\leq 2 \text{ pF}$	$\leq 2 \text{ pF}$
	4, 5, 6 pole: $\leq 7 \text{ pF}$	●	●	-	-
	7 pole: $\leq 9 \text{ pF}$	-	●	-	-

Mechanical

Lifetime	$> 1\,000$ mating cycles	●	●	●	●
Insertion / withdrawal force	$\leq 20 \text{ N}$	●	●	25 N	●
Retention method					
	- standard: latch lock	●	●	● (XLR)	● (XLR)
	- "0" Version: $\geq 20 \text{ N}$ separating force	●	●	25 N	25 N

Material

Insert	Polyamide	PA 6.6 30% GR	●	●	●	●
Shell	Zinc diecast	ZnAl4Cu1	●	●	-	-
Shell plating		gal Ni or black Cr	Ni	●	-	-
Ring	Zinc diecast	ZnAl4Cu1	-	-	-	-
Contacts	- female 3 pole:	Bronze CuSn6	-	●	●	●
	4 – 5 pole:	Bronze CuSn6	-	-	-	-
	4 – 7 pole:	Brass CuZn39Pb3	-	●	-	-
	- male:	Brass CuZn35Pb2	●	●	-	-
Contact surface	gal 0.2 μm AuCo over 2 μm NiP15 (Tribor®)		-	-	●	●
	gal 2 μm Ag or gal 0.2 μm Au hard alloy over 2 μm Ni		Au	●	-	-
Latch lock & spring		Ck 67 steel, treated	-	●	●	●

Environmental

Operating temperature	-30 °C to +80 °C	●	●	●	●
Protection class	IP 40	IP 65	●	●	●
Flammability	UL 94 HB	●	●	●	●
	UL 94 V-0	-	-	-	-
Solderability complies with	IEC 68-2-20	●	●	●	●
Mounting screw		-	-	A	A
Color coding		-	-	-	-

*... P Series male 3 – 6 pole

**... if existing

Ordering Information for Receptacles

Female	Male	Shell	Contact	3 pole	4 pole	5 pole	Female	Male	Shell	Contact	3 pole
A Series							AA Series				
NC*FAH-D		Black Plastic	Gold	-	● ¹⁾	● ¹⁾	NC3FAAH	NC3MAAH	Black Plastic	Gold	●
	NC*MAH	Black Plastic	Gold	●	●	●	NC3FAAH-0		Black Plastic	Gold	●
NC*FAH-0		Black Plastic	Gold	●	● ¹⁾	● ¹⁾	NC3FAAH1	NC3MAAH-1	Black Plastic	Gold	●
	NC3MAH-0	Black Plastic	Gold	●	-	-	NC3FAAH1-0		Black Plastic	Gold	●
NC3FAHL-0		Black Plastic	Gold	●	-	-		NC3MAAH-0	Black Plastic	Gold	●
NC3FAHR-0		Black Plastic	Gold	●	-	-	NC3FAAH2		Black Plastic	Gold	●
NC3FAH1-D		Black Plastic	Gold	●	-	-	NC3AAH2-0		Black Plastic	Gold	●
NC3FAH1-0		Black Plastic	Gold	●	-	-	NC3FAAV	NC3MAAV	Black Plastic	Gold	●
NC3FAHL1-D		Black Plastic	Gold	●	-	-	NC3FAAV-0		Black Plastic	Gold	●
	NC3MAHL	Black Plastic	Gold	●	-	-	NC3FAAV1	NC3MAAV-1	Black Plastic	Gold	●
NC3FAHL1-0		Black Plastic	Gold	●	-	-	NC3FAAV1-0		Black Plastic	Gold	●
NC3FAHR1-D		Black Plastic	Gold	●	-	-		NC3MAAV-0	Black Plastic	Gold	●
	NC3MAHR	Black Plastic	Gold	●	-	-	NC3FAAV2		Black Plastic	Gold	●
NC3FAHR1-0		Black Plastic	Gold	●	-	-	NC3FAAV2-0		Black Plastic	Gold	●
NC3FAH2-D		Black Plastic	Gold	●	-	-					
NC3FAH2-0		Black Plastic	Gold	●	-	-					
NC3FAHR2-D		Black Plastic	Gold	●	-	-					
NC3FAHR2-0		Black Plastic	Gold	●	-	-					
NC*FAV-D		Black Plastic	Gold	-	● ¹⁾	● ¹⁾					
	NC*MAV	Black Plastic	Gold	●	●	●					
NC*FAV-0		Black Plastic	Gold	●	● ¹⁾	● ¹⁾					
	NC3MAV-0	Black Plastic	Gold	●	-	-					
NC3FAV1-D		Black Plastic	Gold	●	-	-					
NC3FAV1-0		Black Plastic	Gold	●	-	-					
NC3FAV2-D		Black Plastic	Gold	●	-	-					
NC3FAV2-0		Black Plastic	Gold	●	-	-					
NC5FAV-SW-D	NC5MAV-SW	Black Plastic	Gold	-	-	●					

A Series – D version come with disassembled Push latch, version with assembled latch omit -D.

AA Series comes with Push Latch assembled.

A / AA Series rear mount only, all PCB mount except Y version = IDC

-DA: with asymmetric push

¹⁾: Grounding Option "2"

0: Retention Spring

Grounding Options

A / AA Series and B Series

Female - 3 pole

"1"

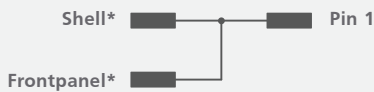

"2"

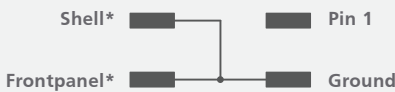

Female 4 & 5 pole

w/o number

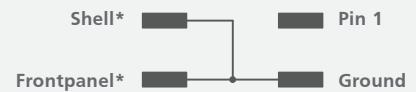

Male - 3, 4 & 5 pole

w/o number

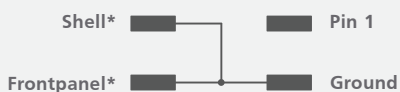

"0" and L + R version

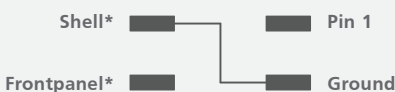

"1"

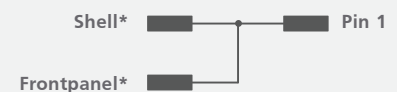

Shell* : Contact to shell of mating connector

Frontpanel* : Connection to frontpanel by fastening screw

Ordering Information for Receptacles

Female Male Flange Contact 3 4 5
pole pole pole

B Series					
NC*FBH		Metal	Gold	-	● ●
	NC*MBH	Metal	Gold	● ● ●	
NC5FBH-B	NC5MBH-B	Black Metal	Gold	-	●
	NC3MBH-B	Black Metal	Gold	●	-
	NC3MBH-0	Metal	Gold	●	-
NC3FBH1	NC3MBH-1	Metal	Gold	●	-
NC3FBH1-B		Black Metal	Gold	●	-
NC3FBHL1		Metal	Gold	●	-
	NC3MBHL	Metal	Gold	●	-
	NC3MBHL-B	Black Metal	Gold	●	-
NC3FBH2		Metal	Gold	●	-
NC3FBH2-B		Black Metal	Gold	●	-
	NC3MBHR	Metal	Gold	●	-
	NC3MBHR-B	Black Metal	Gold	●	-
NC3FBH1-E	NC3MBV-E	Metal	Gold	●	-
NC3FBH2-E		Metal	Gold	●	-
	NC3MBH-E	Metal	Gold	●	-
	NC*MBV	Metal	Gold	● ● ●	
	NC3MBV-B	Black Metal	Gold	●	-
NC*FBV		Metal	Gold	-	● ●
NC5FBV-B	NC5MBV-B	Black Metal	Gold	-	●
NC3FBV1		Metal	Gold	●	-
NC3FBV1-B		Black Metal	Gold	●	-
NC3FBV2		Metal	Gold	●	-
NC3FBV2-B		Black Metal	Gold	●	-
	NC3MBV-0	Metal	Gold	●	-
	NC3MBV-1	Metal	Gold	●	-
NC3FBV2-SW	NC3MBV-SW	Metal	Gold	●	-
NC5FBV-SW	NC5MBV-SW	Metal	Gold	-	●

Female Male Shell Contact 3 4 5 6 7
pole pole pole pole pole

D Series									
NC3FD-V	NC3MD-V	Nickel	Silver	●	-	-	-	-	
NC3FD-V-B	NC3MD-V-B	Black Cr	Gold	●	-	-	-	-	
NC3FD-V-BAG	NC3MD-V-BAG	Black Cr	Silver	●	-	-	-	-	
NC3FDM3-V	NC3MDM3-V	Nickel	Silver	●	-	-	-	-	
NC3FDM3-V-B	NC3MDM3-V-B	Black Cr	Gold	●	-	-	-	-	
NC3FD-H	NC3MD-H	Nickel	Silver	●	-	-	-	-	
NC3FD-H-B	NC3MD-H-B	Black Cr	Gold	●	-	-	-	-	
NC3FD-H-BAG	NC3MD-H-BAG	Black Cr	Silver	●	-	-	-	-	
NC3FDM3-H	NC3MDM3-H	Nickel	Silver	●	-	-	-	-	
NC3FDM3-H-B	NC3MDM3-H-B	Black Cr	Gold	●	-	-	-	-	
NC3FDM3-H-BAG	NC3MDM3-H-BAG	Black Cr	Gold	●	-	-	-	-	

DLX Series

NC*FD-LX	NC*MD-LX	Nickel	Silver	● ● ● ● ●
NC*FD-LX-B	NC*MD-LX-B	Black Cr	Gold	● ● ● ● ●
NC*FD-LX-BAG	NC*MD-LX-BAG	Black Cr	Silver	● ● ● ● -
NC*FD-LX-M3	NC*MD-LX-M3	Nickel	Silver	● ● ● - -
NC3FD-LX-HE	NC3MD-LX-HE	Velour Cr	Gold	● - - - -
NC3FD-LX-WT	NC3MD-LX-WT	White	Silver	● - - - -
NC6FSD-LX	NC6MSD-LX	Nickel	Silver	- - - ● -

DL Series

NC*FD-L-1	NC*MD-L-1	Nickel	Silver	● ● ● ● ●
NC*FD-L-B-1	NC*MD-L-B-1	Black Cr	Gold	● ● ● ● ●
NC*FD-L-BAG-1	NC*MD-L-BAG-1	Black Cr	Silver	● ● ● ● -
NC*FDM3-L-1	NC*MDM3-L-1	Nickel	Silver	● ● ● - -
NC3FDM3LBAG-1	NC3MDM3LBAG-1	Black Cr	Silver	● - - - -
NC3FD-L-1-HE	NC3MD-L-1-HE	Velour Cr	Gold	● - - - -
NC*FDM3-H	NC*MDM3-H	Nickel	Silver	- ● ● ● -
NC*FDM3-H-B	NC*MDM3-H-B	Nickel	Silver	- ● ● - -
NC*FDM3-H-BAG	NC*MDM3-H-BAG	Black Cr	Silver	- ● ● - -
NC3FD-S-1-B	NC3MD-S-1-B	Black Cr	Silver	● - - - -

0: Retention spring on request

DLX Crimp Series

NC3FD-LX-HA	NC3MD-LX-HA	Nickel	Silver	● - - - -
NC3FD-LX-HA-BAG	NC3MD-LX-HA-BAG	Black Cr	Silver	● - - - -

-DA: with asymmetric push

D: version come with disassembled Push latch, version with assembled latch omit -D.

B: Series rear mount only

0: Retention spring on request



Ordering Information for Receptacles

Female	Male	Shell	Contact	3	4	5	6	7
				pole	pole	pole	pole	pole

Shell	Contact	5	6	9	10
		pole	pole	pole	pole

EMC XLR

NC3FDX-EMC-SPEC	Black Cr	Gold	●	-	-	-	-
-----------------	----------	------	---	---	---	---	---

Accessories

FDR-1	Black round panel mounting flange with screws for larger panel cut-outs
-------	---

P Series

NC*FP-1	Nickel	Silver	●	●	●	●	●
NC*MP	Nickel	Silver	●	●	●	●	-
NC*FP-B-1	Black Cr	Gold	●	●	●	●	●
NC*MP-B	Black Cr	Gold	●	●	●	●	-
NC*FP-BAG-1	NC*MP-BAG	Black Cr	Silver	●	●	●	-

MPR-HD Series

-	NC*MPR-HD	Nickel	Gold	●	●	●	-	-
---	-----------	--------	------	---	---	---	---	---

Combo A Series

NCJ6FA-H	Black plastic	Gold	-	●	-	-	-
NCJ6FA-H-0	Black plastic	Gold	-	●	-	-	-
NCJ6FA-H-DA	Black plastic	Gold	-	●	-	-	-
NCJ6FA-V	Black plastic	Gold	-	●	-	-	-
NCJ6FA-V-0	Black plastic	Gold	-	●	-	-	-
NCJ6FA-V-DA	Black plastic	Gold	-	●	-	-	-

Combo Series

NCJ*FI-H	Black plastic	Gold	●	●	●	●	●
NCJ*FI-H-0	Black plastic	Gold	●	●	●	●	●
NCJ*FI-S	Black plastic	Gold	●	●	●	●	●
NCJ*FI-S-0	Black plastic	Gold	●	●	●	●	●
NCJ*FI-V	Black plastic	Gold	●	●	●	●	●
NCJ*FI-V-0	Black plastic	Gold	●	●	●	●	●

Contact

	1	2	3	T	R	S	TN	RN	SN	G	GN
NCJ5FI-*	x	x	x	x		x					x
NCJ6FI-*	x	x	x	x	x	x					x
NCJ9FI-*	x	x	x	x	x	x	x	x	x	x	x
NCJ10FI-*	x	x	x	x	x	x	x	x	x	x	x

Panel Cutouts

A / AA / B Series

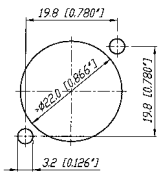

D / DL / DLX Series

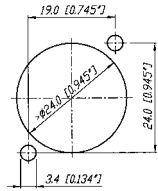

P Series Female

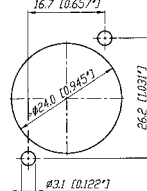

P Series Male

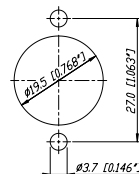

Combo

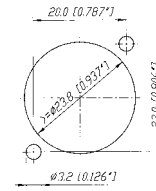

MPR Series



Assembly Tools



HTXP



BTXX



HX-R-BNC



DIE-R-BNC-PT

HTXP	Hand tool to tighten the XX and PX-bushing
HTXX-14	Hand tool to tighten the XX-14 and 8 + 2 pole bushing
BTXX	Speed boot assembly tool to press the XX boot onto shell
HX-R-BNC	Crimp tool for XCC Series
DIE-R-BNC-PT	Crimp die for XCC Series (6.5 mm HEX)
DIE-R-HA-1	Crimp die for XX-HA Series