

Frontplattenausschnitt (Rückseite)
panel cut out (rear side)

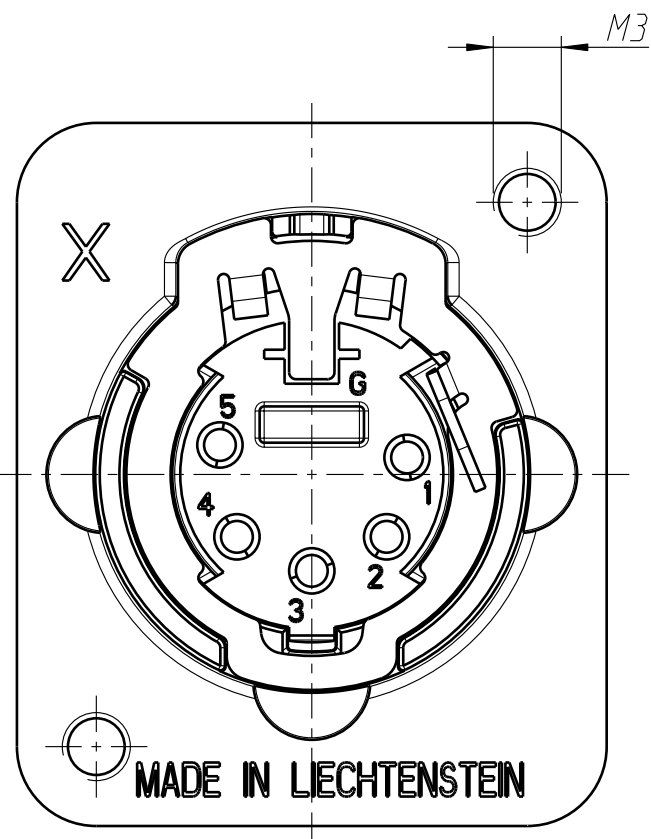
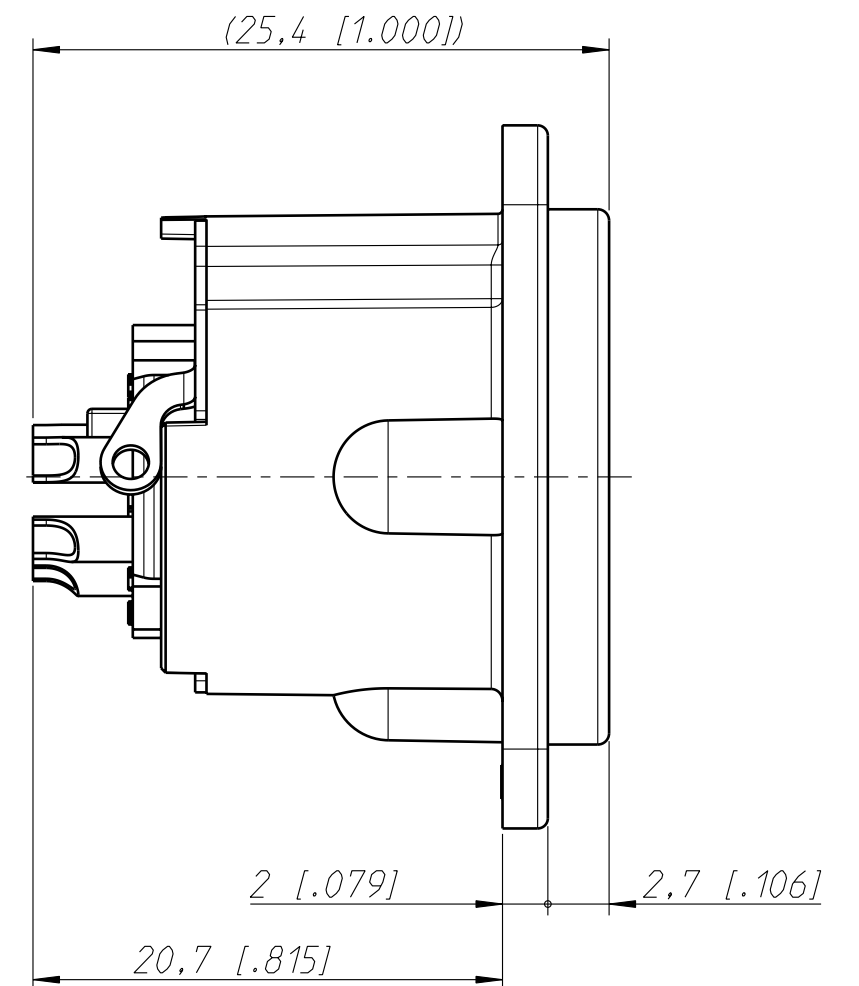
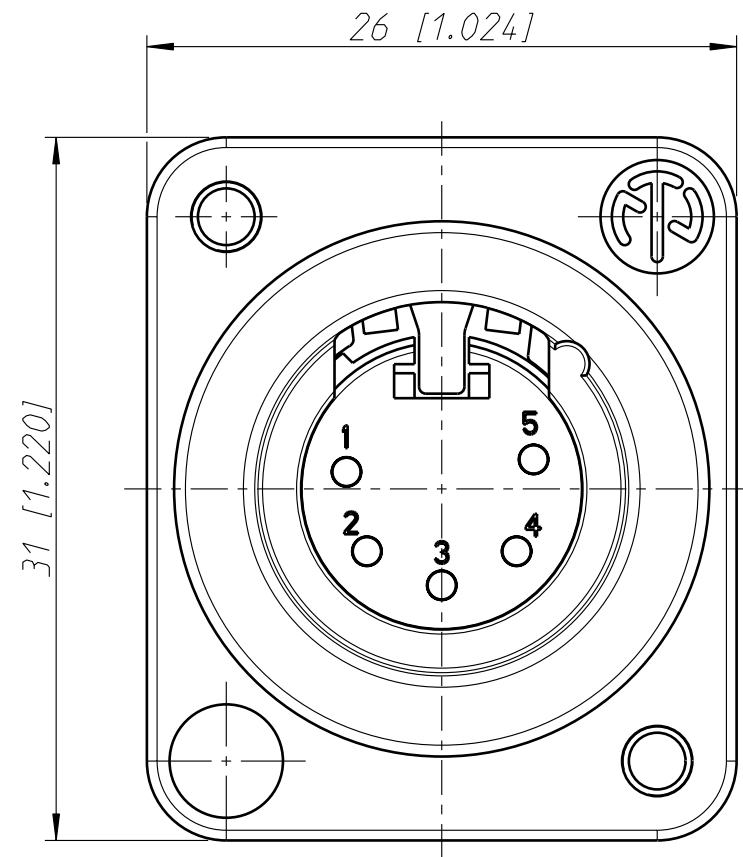
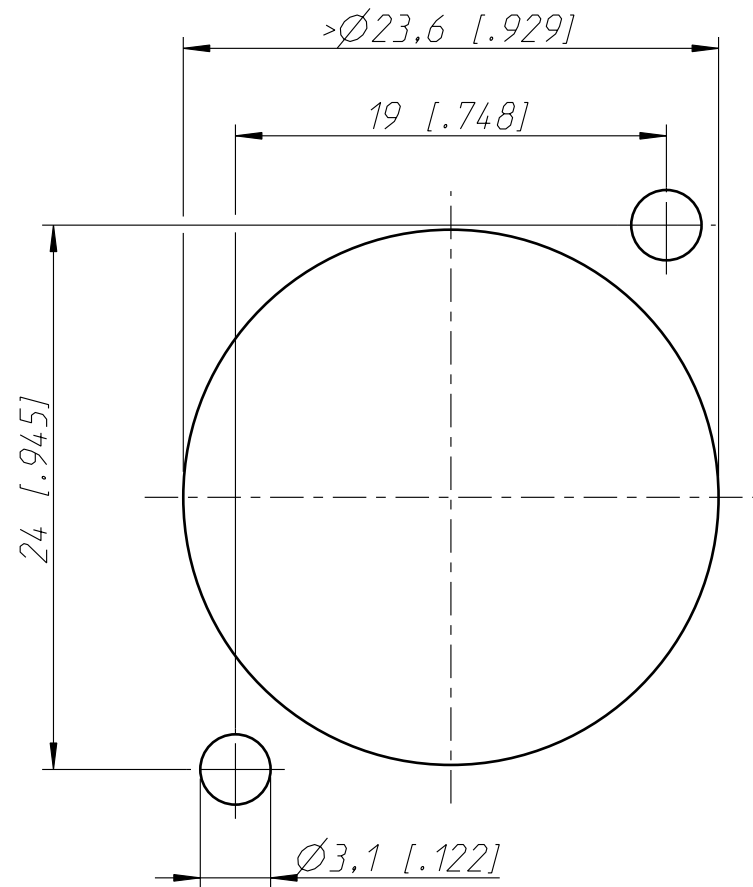

Allgemeintoleranzen ISO 2768-m	Werkstoff KEIN_MAT	Massstab: 3:1 (A3)	Gezeichnet	Datum	Name
			Freigegeben	19.06.06	Ender
Zeichnung urheberrechtlich geschuetzt (DIN 34) (C)	-	-	Geaendert	-	-
			Aend.-Nr.	-	Aend.-Index
Benennung NC5MD-LX-M3 NC5MD-LX-M3			Ersatz fuer:	Blatt 1 von 1 Bl.	
NEUTRIK AG FL-9494 SCHAAN			Zeichn. Nr.	ST-NC5MD-LX-M3	