

Frontplattenausschnitt (Frontseite)  
Panel cut out (front side)

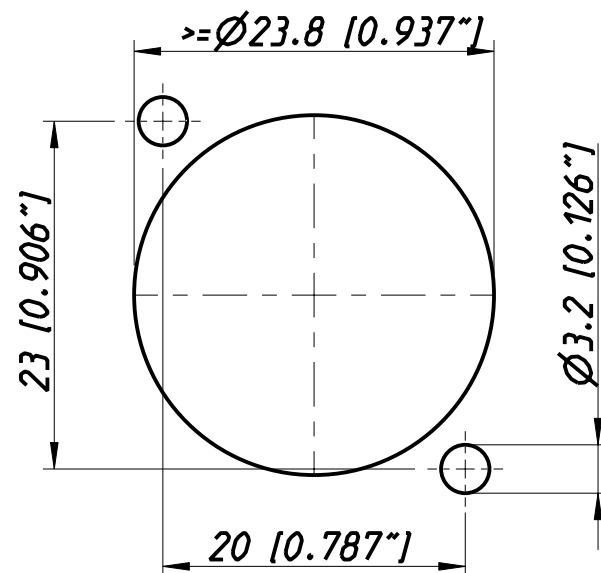

CONTACTS

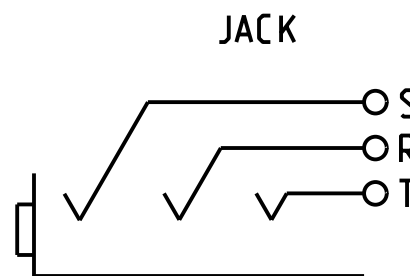

XLR

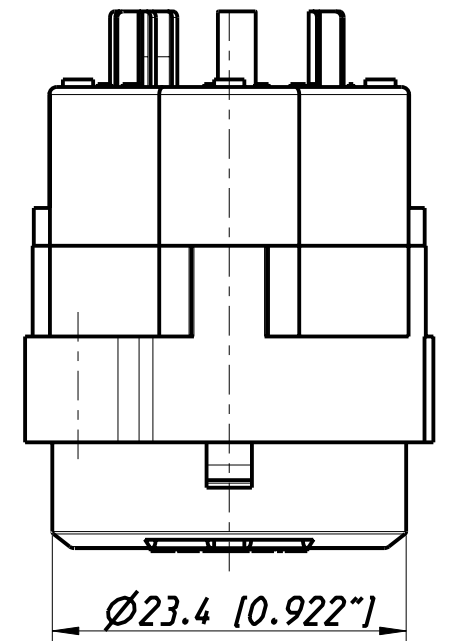
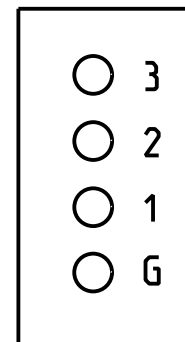

Allgemeintoleranzen ISO 2768-m	Werkstoff	Massstab:	Datum	Name
	KEIN_MAT	2:1 (A3)	25.05.98	Dobler
Zeichnung urheberrechtlich geschuetzt (DIN 34) (C)	-		Freigegeben	-
			Geaenderf	07.11.03
Benennung			Aend.-Nr.	Aend.-Index
NC J6F1-S-0			245-2003	A
			Ersatz fuer:	Blatt 1 von 1 Bl.
NEUTRIK AG FL-9494 SCHAAN			Zeichn. Nr.	
			3102ST1729	