

# NCL30083FLYGEVB, NCL30083BB1GEVB



ON Semiconductor®

<http://onsemi.com>

## 10 W Passive PFC Flyback and Buck-Boost Dimmable LED Driver Evaluation Board User's Manual

### EVAL BOARD USER'S MANUAL

#### Introduction

This documentation package covers two NCL30083 LED driver implementations illustrating their use in an E26/E27 based A, PAR and BR LED lamps form factor. The Electronic Circuit Assembly (ECA) is designed to support

either an isolated flyback or non-isolated buck-boost configuration. The nominal total power is 10 W for either application. The selection is controlled through selective component population of the ECA.

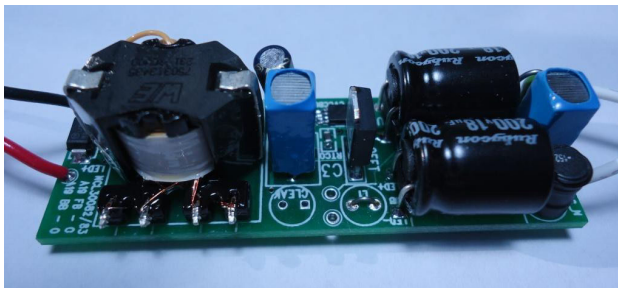

Figure 1. NCL30083FLYGEVB – Flyback

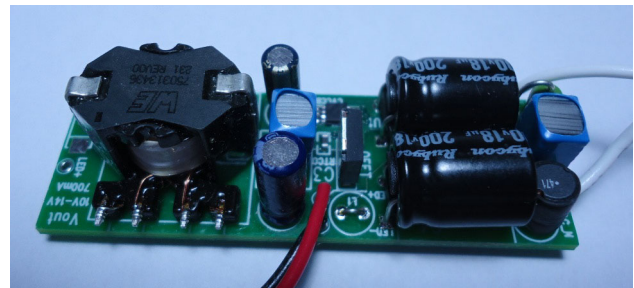

Figure 2. NCL30083BB1GEVB – Buck-Boost

Table 1. DESIGN PARAMETER

Input Voltage	100 – 265 V ac	
Line Frequency	50 Hz/60 Hz	
Power Factor	> 0.7	
Safety (Designed to Meet)	IEC61347-2-13	EU
	UL8750	US
Optimized Output Voltage Range Flyback (NCL30083FLYGEVB) Buck Boost (NCL30083BB1GEVB)	9.6 – 22.1 V dc 30 – 60 V dc	
Output Current Flyback (NCL30083FLYGEVB) Buck Boost (NCL30083BB1GEVB)	500 mA dc 195 mA dc	±2 %
Output Ripple Flyback (NCL30083FLYGEVB) Buck Boost (NCL30083BB1GEVB)	200 mA P-P 50 mA P-P	
Efficiency Flyback (NCL30083FLYGEVB) Buck Boost (NCL30083BB1GEVB)	85% 90%	Typ.
Start Up Time	< 500 msec	Typ.

**Demo Board Modifications**

The board as shipped contains the NCL30083 to demonstrate the line step dimming function which allows the LEDs to be dimmed in 5 discrete steps by toggling the AC line ( $V_{in}$ ) off momentarily.  $C_{vccbulk}$  holds up  $V_{CC}$  while  $V_{in}$  toggles low switching to the next lower dim level. Since the timing is user controlled by switching on/off the light switch the timing window is very wide. Toggling the AC input in one second is typical. It may take more than 20 seconds of AC off to reset the IC, at which time when turned on again it return to the 100% state. By removing the  $C_{vccbulk}$  the step dimming function is effectively disabled so the performance of the current control is just like the NCL300082. It is also possible with this board to replace the NCL30083 with an NCL30082 to evaluate the analog/dimming control.

The value of  $R_{sense}$  sets the final output current value in conjunction with  $R_{trim}$  which is for fine adjustment. The nature of the primary side loop control makes the current adjustment somewhat iterative because several circuit parameters affect the output current setting. It is relatively easy by changing  $R_{sense}$  to increase the output of the evaluation board as long as the output power limit is considered.

Since the NCL30082/3 has a wide  $V_{CC}$  range this allows one transformer/inductor design to a  $> 2:1$  change in LED string forward voltage. If it is desired to reduce the output current, the output power is no longer the limit, but simply the level of the reflected voltage from the auxiliary winding which is monitored by the built in overvoltage protection of the  $V_{CC}$  pin. If a higher output voltage at lower current is required, the auxiliary winding turns ratio would have to be modified.

The input capacitor network uses a valley fill PFC to achieve a power factor of  $> 0.8$  to easily meet ENERGY STAR<sup>®</sup> input power factor requirements. If compliance with EN61000-3-2 Class C is required, the input capacitor network can be easily modified and simplified to one capacitor, this is discussed in the appendix.

**Constant Current Control Architecture Introduction**

Figure 4 portrays the primary and secondary current of a fly-back converter in discontinuous conduction mode (DCM). Figure 3 shows the basic circuit of a fly-back converter.

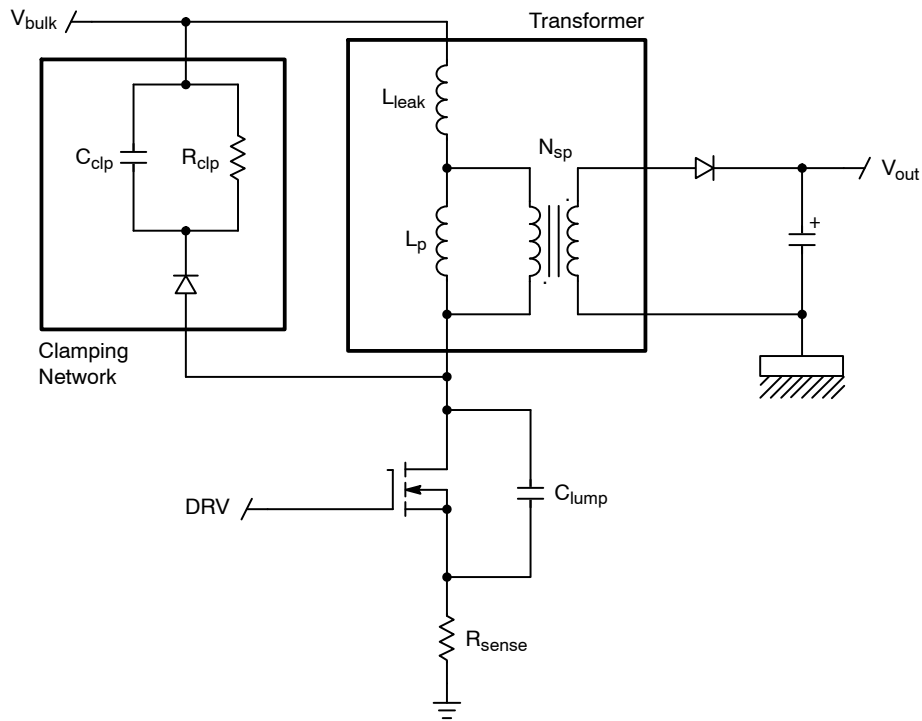

**Figure 3. Basic Flyback Converter Schematic**

During the on-time of the MOSFET, the bulk voltage  $V_{bulk}$  is applied to the magnetizing and leakage inductors  $L_p$  and  $L_{leak}$ . The current ramps up.

When the MOSFET is turned-off, the inductor current first charges  $C_{lump}$ . The output diode is off until the voltage across  $L_p$  reverses and reaches:

$$N_{sp} (V_{out} + V_f)$$

The output diode current increase is limited by the leakage inductor. As a consequence, the secondary peak current is reduced:

$$I_{D,pk} < \frac{I_{L,pk}}{N_{sp}}$$

The diode current reaches its peak when the leakage inductor is reset. Thus, in order to accurately regulate the output current, we need to take into account the leakage inductor current. This is accomplished by sensing the clamping network current. Practically, a node of the clamp capacitor is connected to  $R_{sense}$  instead of the bulk voltage  $V_{bulk}$ . Then, by monitoring the voltage on the CS pin, we have an image of the primary current (red curve in Figure 4).

When the diode conducts, the secondary current decreases linearly from  $I_{D,pk}$  to zero. When the diode current has turned off, the drain voltage begins to oscillate because of the resonating network formed by the inductors ( $L_p + L_{leak}$ ) and the lump capacitor. This voltage is reflected on the auxiliary winding wired in fly-back mode. Thus, by looking

at the auxiliary winding voltage, we can detect the end of the conduction time of secondary diode. The constant current control block picks up the leakage inductor current, the end of conduction of the output rectifier and controls the drain current to maintain the output current constant. We have:

$$I_{out} = \frac{V_{REF}}{2N_{sp} R_{sense}} \quad (eq. 1)$$

The output current value is set by choosing the sense resistor:

$$R_{sense} = \frac{V_{ref}}{2N_{sp} I_{out}} \quad (eq. 2)$$

From (eq. 1), the first key point is that the output current is independent of the inductor value. Moreover, the leakage inductance does not influence the output current value as the reset time is taken into account by the controller.

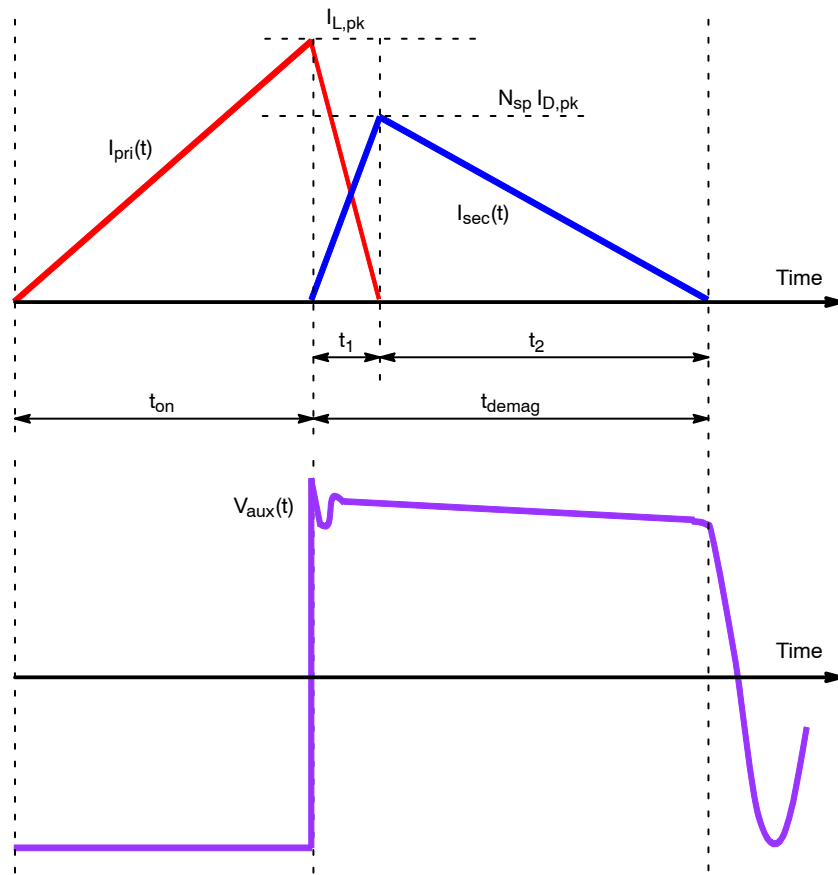

Figure 4. Flyback Currents and Auxiliary Winding Voltage in DCM

At this point the Excel® spreadsheet based design guide will help with many of the calculations.

A trim resistor allows for making fine adjustments to the current limit to set the output current precisely. The LFF

circuit will create some error on the Cs pin which is adjusted out by proper choice of  $R_{trim}$ . So we will choose  $R_{sense} = 1.8 \Omega$  and use  $R_{trim}$  for the fine adjustments. After setting R4 to 1.1 k $\Omega$ ,  $R_{trim}$  is 22  $\Omega$ .



## NCL30083FLYGEVB, NCL30083BB1GEVB

**Table 2. BILL OF MATERIALS**

Qty	Designator	Board Version		Part	Manufacturer	Mfr Part Number	Sub	Pb-Free
		FB	BB					
1	CVccbulk	x*	x*	27 $\mu$ F	Panasonic	EEU-FC1E270	Yes	Yes
1	CVcc	x	x	4.7 $\mu$ F	Taiyo Yuden	EMK107ABJ475KA-T	Yes	Yes
1	Cleak		x	4.7 $\mu$ F	Rubycon	100YXJ4R7M5X11	Yes	Yes
1	Cout	x		22 $\mu$ F 16 V	Taiyo Yuden	EMK316BJ226ML-T	Yes	Yes
2	C2, C4	x	x	18 $\mu$ f 200 V	Rubycon	200LLE18MEFC10X12.5	Yes	Yes
2	C3, C5	x	x	120 nF 400 V	Epcos	B32559C6124+***	Yes	Yes
2	C10, C11	x	x	1 nF	Kemet	C0402C102K3GACTU	Yes	Yes
1	C13	x		1000 pF 630 V	Kemet	C0805C102KBRCTU	Yes	Yes
2	C14, C15	x		470 pF 250 VAC Y2	Johanson Dielectric	502R29W471KV3E-****-SC	Yes	Yes
4	D1, D2, D3, Dleak	x	x	UFM15PL	MCC	UFM15PL	Yes	Yes
1	Dout	x		MURA220T3	On Semiconductor	MURA220T3	No	Yes
1	D4	x	x	MB6S	MCC	MB6S	Yes	Yes
1	D9	x	x	BAS21DW5T1G	ON Semiconductor	BAS21DW5T1G	No	Yes
1	F1	x	x	FUSE	Littelfuse	0263.500WRT1L	Yes	Yes
1	L1	x	x	220 $\mu$ H	Würth	7447462221	Yes	Yes
1	L2	x	x	1.5 mH	Würth	7447462152	Yes	Yes
1	Qfet	x	x	NDD02N60Z	ON Semiconductor	NDD02N60Z	No	Yes
1	Rbo	x	x	3.01 M $\Omega$	Yageo	RC0805FR-073M01L	Yes	Yes
1	Rclamp	x		47 k $\Omega$	Yageo	RC0805FR-0747K0L	Yes	Yes
1	Rdamp	x	x	180 $\Omega$	Yageo	RC0805JR-07180RL	Yes	Yes
1	Rgd	x	x	10 $\Omega$	Yageo	RC0603FR-0710RL	Yes	Yes
1	Rjump1	x*	x*	0 $\Omega$	Yageo	RC0402JR-070RL	Yes	Yes
1	Rtco_trim	x	x	10 k $\Omega$	Yageo	RC0402FR-0710KL	Yes	Yes
1	R8	x		10 k $\Omega$	Yageo	RC0402FR-0710KL	Yes	Yes
0	Rjump2	*	-*	10 k $\Omega$	Yageo	RC0402FR-0710KL	Yes	Yes
1	Rlff	x	x	620 $\Omega$	Yageo	RC0402FR-07620RL	Yes	Yes
1	Rsens		x	0.68 $\Omega$	Yageo	RL0603FR-070R68L	Yes	Yes
		x		0.78 $\Omega$		RL0603FR-070R78L	Yes	Yes
2	Rstart1, Rstart	x	x	1.0 M $\Omega$	Yageo	RC0805FR-071ML	Yes	Yes
1	Rtco	x	x	100 k $\Omega$ NTC	Epcos	B57331V2104J60	Yes	Yes
1	Rtrim	x		7.15 $\Omega$	Vishay/Dale	CRCW06037R15FKEA	Yes	Yes
			x	5.1 $\Omega$	Stackpole	RMCF0603FT5R10	Yes	Yes
1	Rzcd	x	x	56 k $\Omega$	Yageo	RC0805FR-0756KL	Yes	Yes
1	R2	x	x	51.1 k $\Omega$	Yageo	RC0402FR-0751K1L	Yes	Yes
1	R5	x	x	4.7 $\Omega$	Yageo	RC0805JR-074R7L	Yes	Yes
1	R9	x		100 $\Omega$	Yageo	RC0805JR-07100RL	Yes	Yes
1	T1	x		XFRM_LINEAR	Würth	750313435	No	Yes
			x			750313436	No	Yes
1	U1	x*	x*	NCL30083	ON Semiconductor	NCL30083BDMR2G	No	Yes
2	Wire , Input, White	x	x	UL1430	Alpha Wire	#24 AWG, Stranded, 6"	Yes	Yes
1	Wire, Output, Red	x	x	UL1430	Alpha Wire	#24 AWG, Stranded, 6"	Yes	Yes
1	Wire, Output, Black	x	x	UL1430	Alpha Wire	#24 AWG, Stranded, 6"	Yes	Yes

\*To convert the board to NCL30082, the identified components are changed, see NCL30082 configuration table.

# NCL30083FLYGEVB, NCL30083BB1GEVB

**Table 3. NCL30082 CONFIGURATION TABLE**

Topology	Dimming	Controller	Cvccbulk	Rjump1	Rjump2
Flyback (FB)	Step Dimming	NCL30083	X	X	
	No DIM Pin Access	NCL30082	Remove	Remove	
	Access Dimming Pin	NCL30082	Replace with Connector*	Remove	X
Buck Boost (BB)	Step Dimming	NCL30083	X	X	
	No DIM Pin Access	NCL30082	Remove	Remove	
	Access Dimming Pin	NCL30082	Replace with Connector*	Remove	X

Notes:	Connector Assembly	Supplier	Part Number
	* Board Connector	Molex	22035025
	Mating Connector	Molex	50375023
	Connector Terminal	Molex	8701039

## GERBER VIEWS

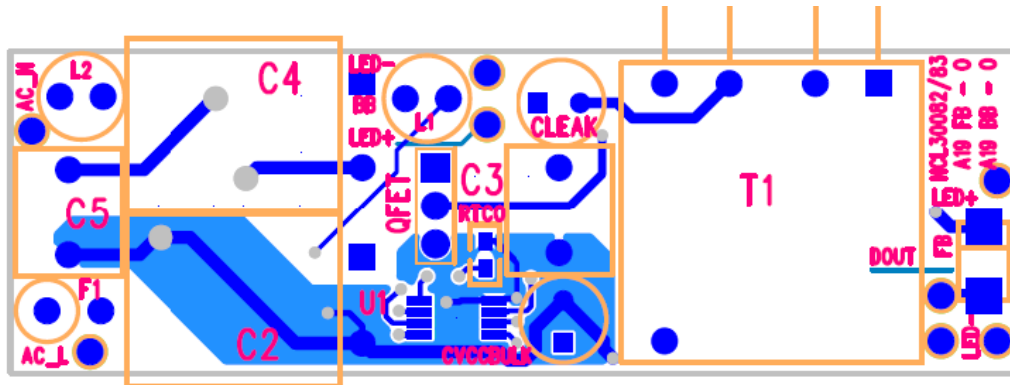

**Figure 7. Top Side PCB**

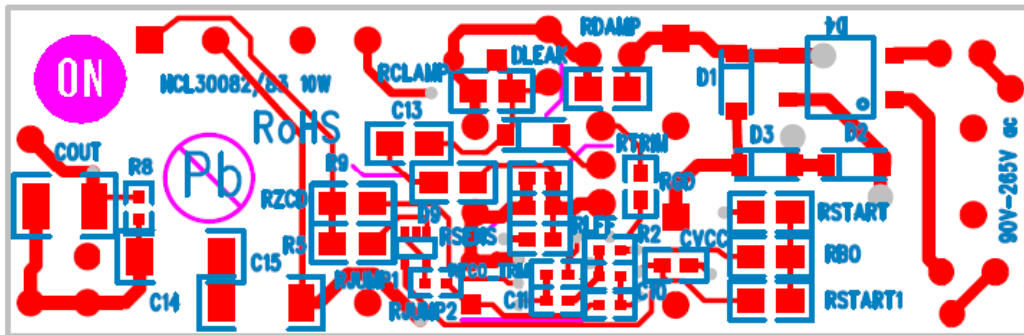

**Figure 8. Bottom Side PCB**



# NCL30083FLYGEVB, NCL30083BB1GEVB

## FLYBACK TRANSFORMER SPECIFICATION

CUSTOMER TERMINAL	RoHS	LEAD(Pb)-FREE
Sn 96%, Ag 4%	Yes	Yes

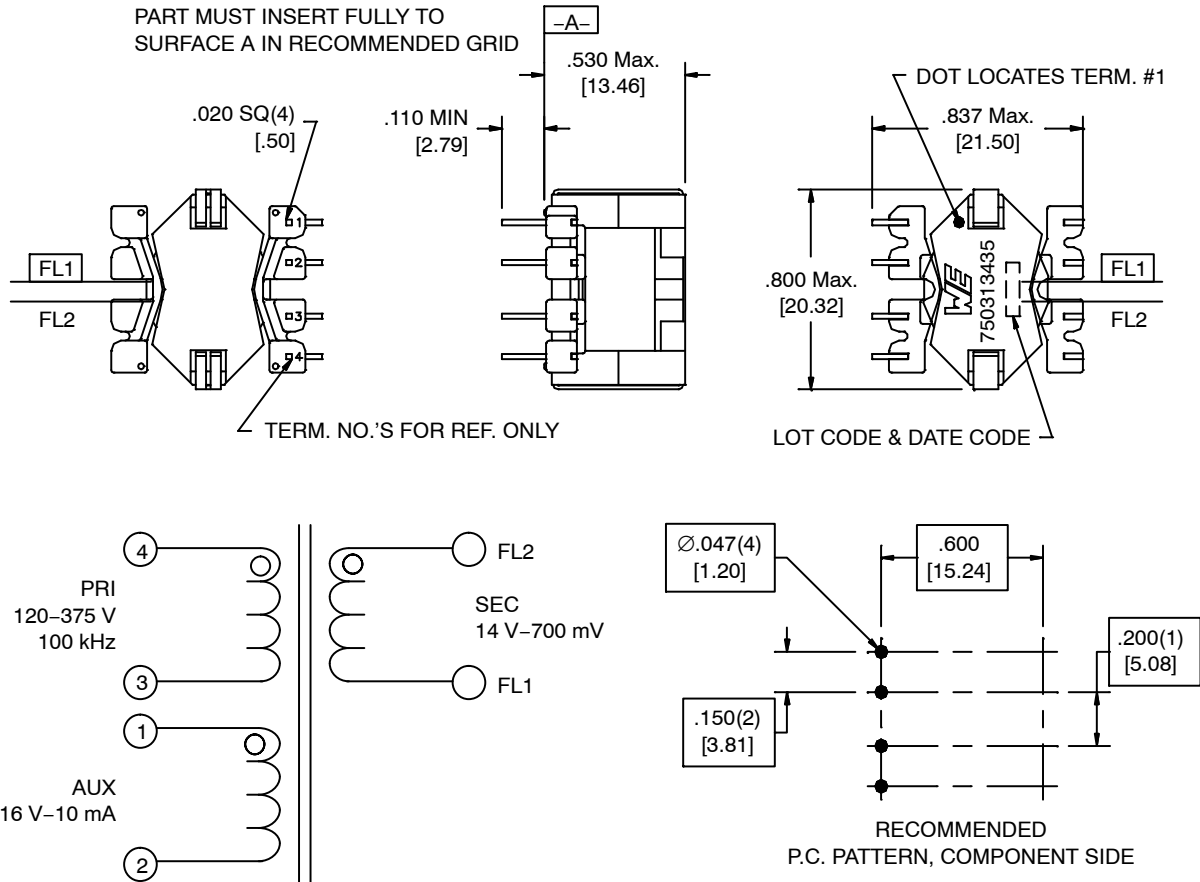

### ELECTRICAL SPECIFICATIONS @ 25°C unless otherwise noted:

D.C. RESISTANCE (@ 20°C): 1-2 1.25  $\Omega$   $\pm$ 10%.

3-4, 0.695  $\Omega$   $\pm$ 10%.

FL1-FL2, 0.090  $\Omega$   $\pm$ 20%.

DIELECTRIC RATING: 3,000 VAC, 1 minute tested by applying 3,750 VAC for 1 second between pins 4-FL1 (tie 2+3).  
500 VAC, 1 minute tested by applying 625 VAC for 1 second between pins 1-4.

INDUCTANCE: 700  $\mu$ H  $\pm$ 10%, 10 kHz, 100 mVAC, 0 mADC, 3-4, Ls.

SATURATION CURRENT: 1 A saturating current that causes 20% rolloff from initial inductance.

LEAKAGE INDUCTANCE 5.0  $\mu$ H max, 100 kHz, 100 mVAC, 1-2 (tie FL1+FL2), Ls.  
15.0  $\mu$ H max, 100 kHz, 100 mVAC, 3-4 (tie FL1+FL2), Ls.

TURNS RATIO: (4-3):(1-2), (2.5):(1.00),  $\pm$ 1%.  
(4-3):(FL1-FL2), (3):(1.00),  $\pm$ 1%.

OPERATING TEMPERATURE RANGE: -40°C TO 125°C including temp. rise.

Unless otherwise specified, tolerances are as follows: Angles:  $\pm$ 1° Fractions:  $\pm$ 1/64 Decimals:  $\pm$ 0.005 (.127 mm)

This drawing is dual dimensioned. Dimensions in brackets are in millimeters.



# NCL30083FLYGEVB, NCL30083BB1GEVB

## BUCK BOOST INDUCTOR SPECIFICATION

CUSTOMER TERMINAL	RoHS	LEAD(Pb)-FREE
Sn 96%, Ag 4%	Yes	Yes

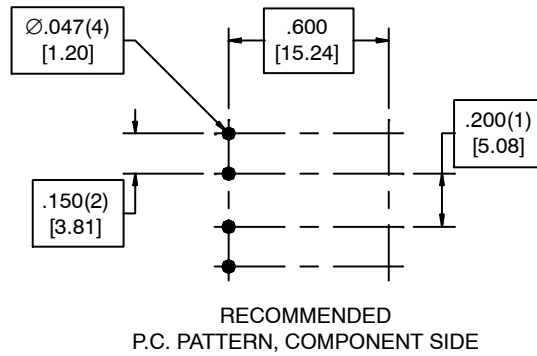
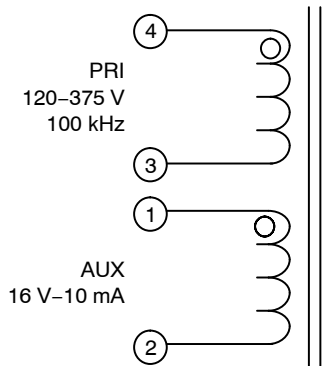
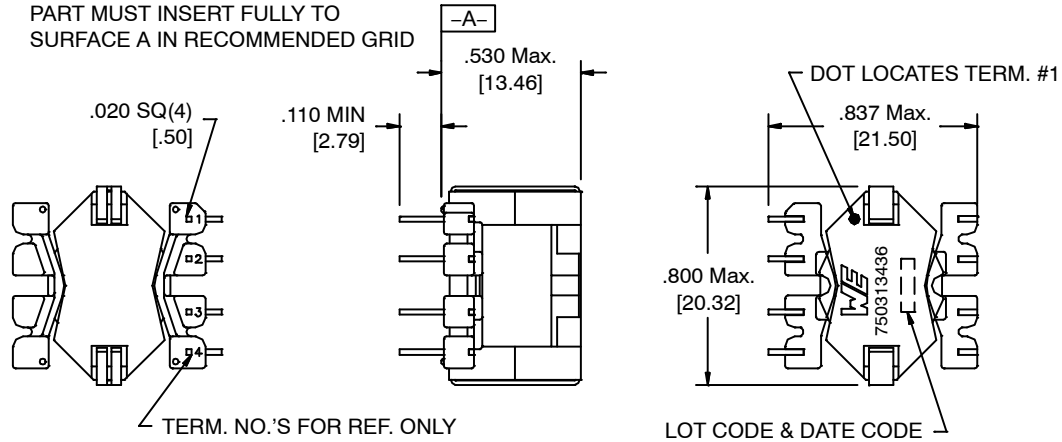

### ELECTRICAL SPECIFICATIONS @ 25°C unless otherwise noted:

D.C. RESISTANCE (@ 20°C): 1-2 0.450  $\Omega$   $\pm$ 10%.  
3-4, 0.965  $\Omega$   $\pm$ 10%.

DIELECTRIC RATING: 1,000 VAC, 1 minute tested by applying 1,250 VAC for 1 second between pins 1-4.

INDUCTANCE: 950  $\mu$ H  $\pm$ 10%, 10 kHz, 100 mVAC, 0 mADC, 3-4, Ls.

SATURATION CURRENT: 1 A saturating current that causes 20% rolloff from initial inductance.

LEAKAGE INDUCTANCE 25.0  $\mu$ H max, 100 kHz, 100 mVAC, 3-4 (tie 1+2), Ls.

TURNS RATIO: (4-3):(1-2), (3):(1.00),  $\pm$ 1%.

OPERATING TEMPERATURE RANGE: -40°C TO 125°C including temp. rise.

Unless otherwise specified, tolerances are as follows: Angles:  $\pm$ 1° Fractions:  $\pm$ 1/64 Decimals:  $\pm$ 0.005 (.127 mm)

This drawing is dual dimensioned. Dimensions in brackets are in millimeters.

# NCL30083FLYGEVB, NCL30083BB1GEVB

## FLYBACK ECA PICTURES

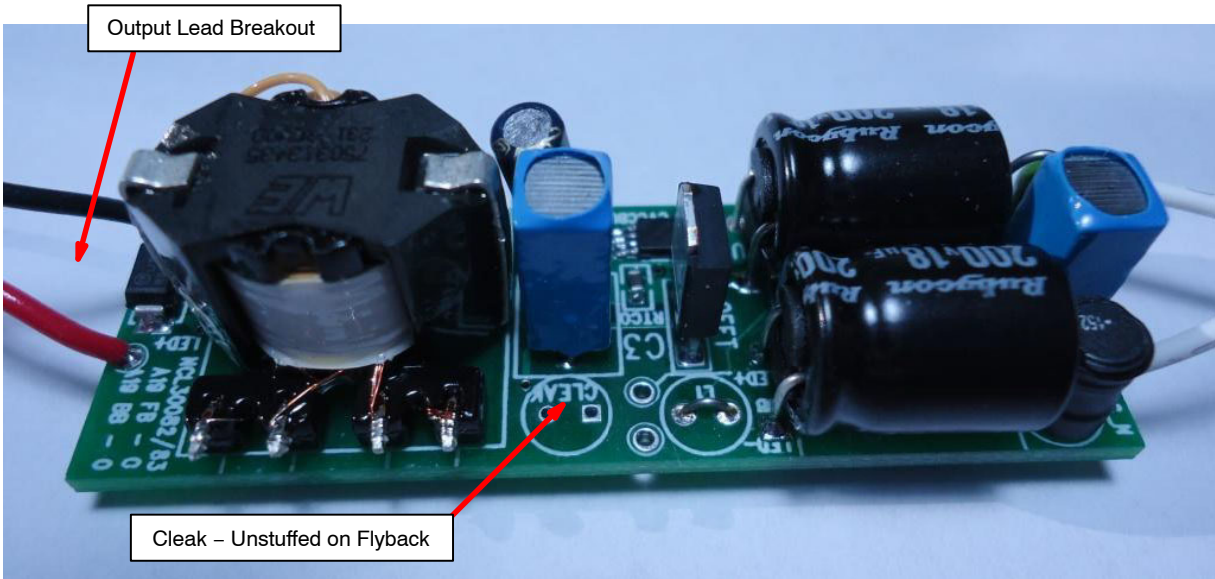

Figure 11. Flyback Top View

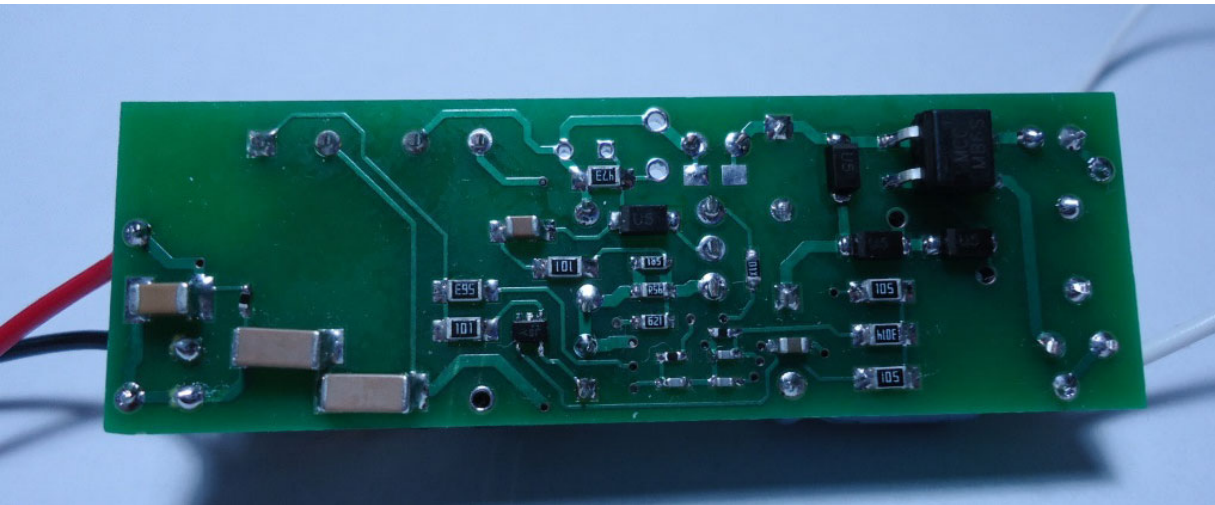

Figure 12. Flyback Bottom View

BUCK BOOST ECA PICTURES

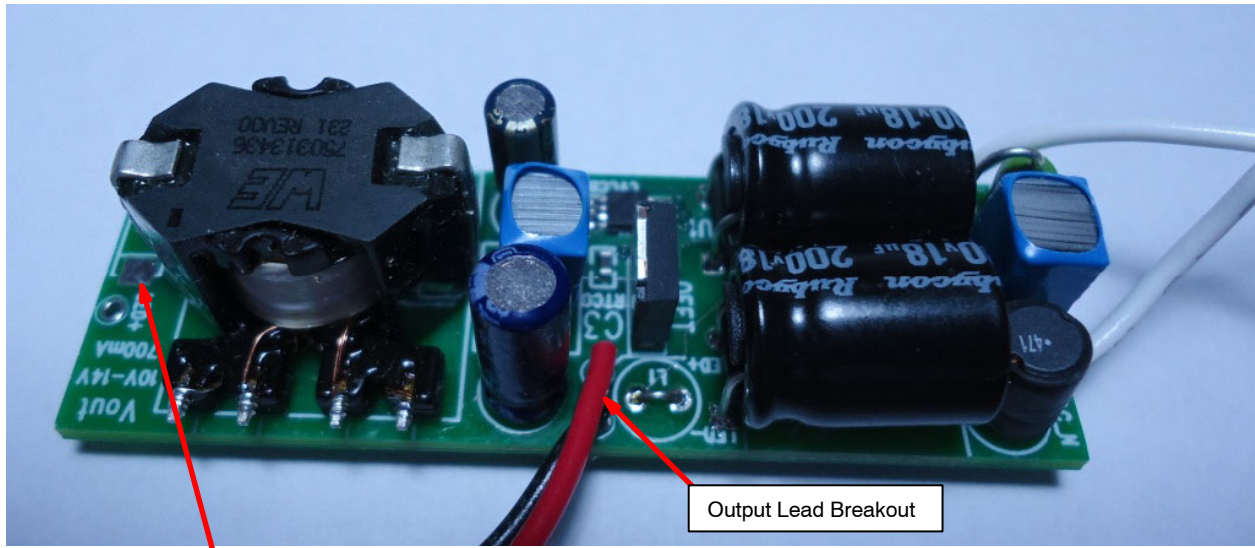

Figure 13. Buck Boost Top View

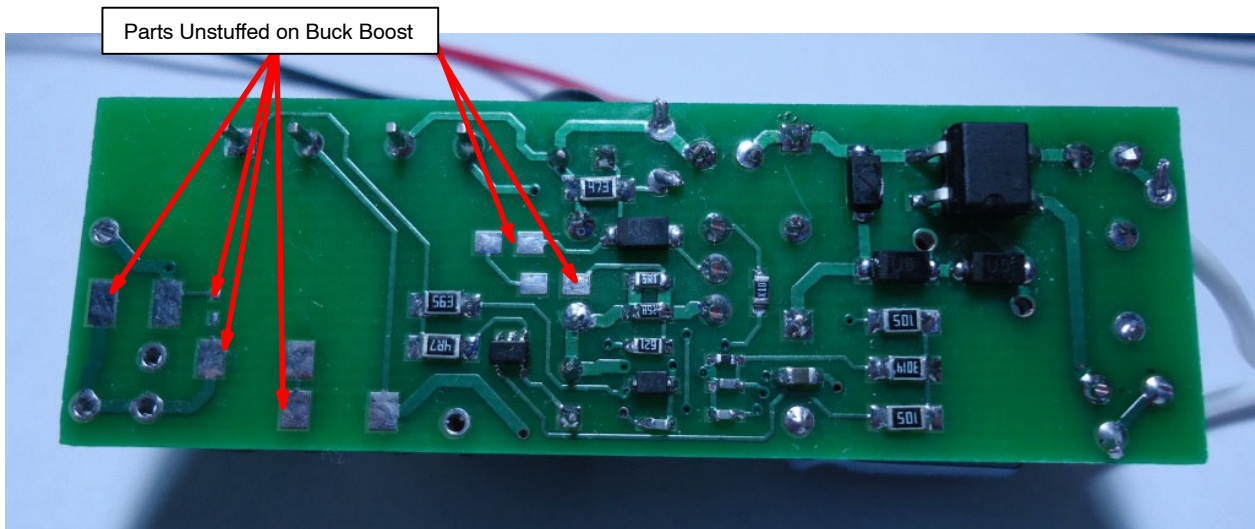

Figure 14. Buck Boost Bottom View

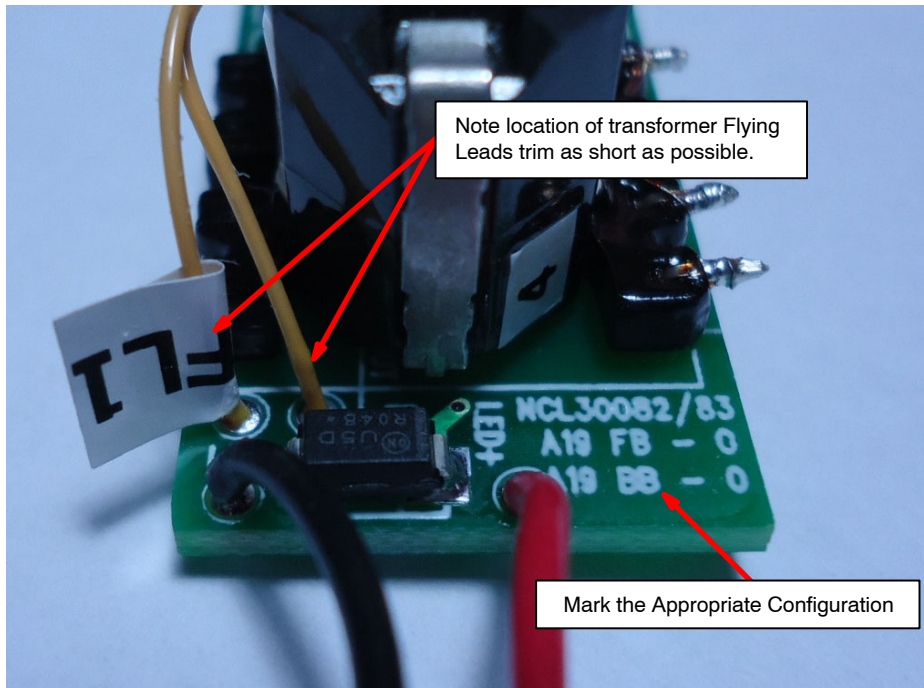

Figure 15. Flyback Lead Breakout

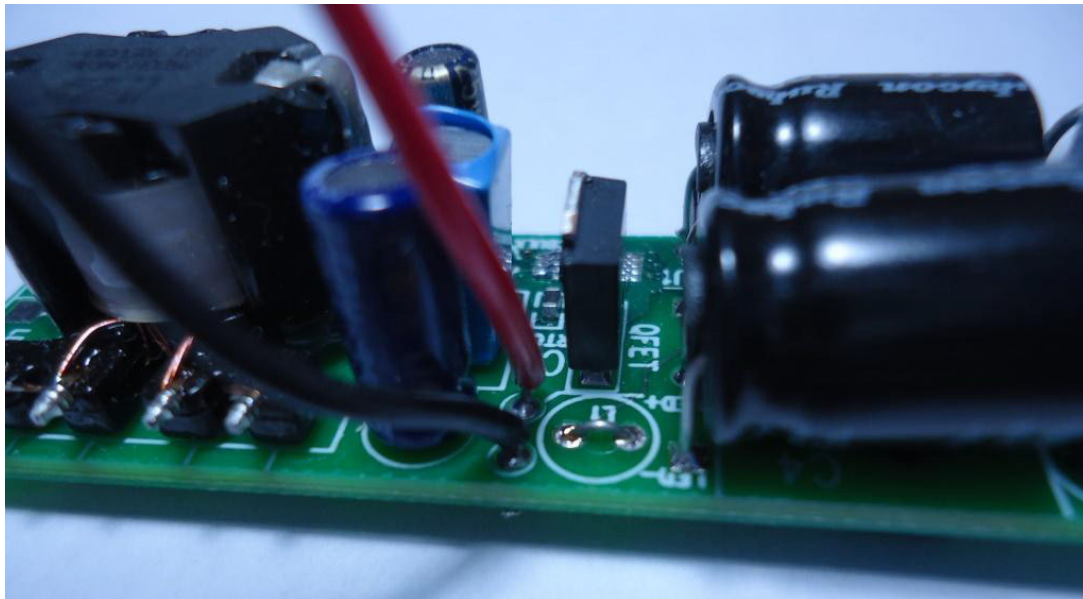

Figure 16. Buck Boost Lead Breakout

# NCL30083FLYGEVB, NCL30083BB1GEVB

## TEST PROCEDURE

### Equipment Needed

- AC Source – 100 to 265 V ac 50/60 Hz Minimum 1 A ac capabilities
- AC Wattmeter – 30 W Minimum, True RMS Input Voltage and Current, Power Factor 0.2% accuracy or better
- DC Voltmeter – 100 V dc minimum 0.1% accuracy or better
- DC Ammeter – 1 A dc minimum 0.1% accuracy or better
- LED Load

- ♦ Flyback – 14–17 V dc – 5 LED Load @ 500 mA
- ♦ Buck Boost – 50–55 V dc – 15 LED Load @ 200 mA

### Test Connections

1. Connect the Unit Under Test (UUT) per the test set up in Figure 17.
2. Set the AC source to 120 ±1 V ac RMS 60 Hz or 230 ±2 V ac RMS 50 Hz.

NOTE: Unless otherwise specified, all voltage measurements are taken at the terminals of the UUT.

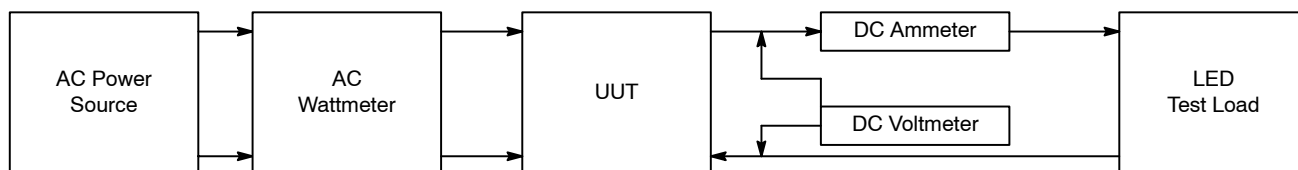

Figure 17. Test Set Up

### Functional Test Procedure

Table 4. FLYBACK VERSION (NCL30083FLYGEVB)

Test Condition	Test Variable	Test Limits		Pass/Fail
		Min	Max	
V <sub>in</sub> = 100 V ac	Output Current	490 mA	510 mA	
V <sub>in</sub> = 120 V ac	Output Current	490 mA	510 mA	
V <sub>in</sub> = 265 V ac	Output Current	490 mA	510 mA	
V <sub>in</sub> = 265 V ac	Power Factor	0.70		
V <sub>in</sub> = 120 V ac V <sub>out</sub> = 14 V	Efficiency (Use Actual Measured Data)	82%		

Table 5. BUCK BOOST VERSION (NCL30083BB1GEVB)

Test Condition	Test Variable	Test Limits		Pass/Fail
		Min	Max	
V <sub>in</sub> = 100 V ac	Output Current	190 mA	200 mA	
V <sub>in</sub> = 120 V ac	Output Current	190 mA	200 mA	
V <sub>in</sub> = 265 V ac	Output Current	190 mA	200 mA	
V <sub>in</sub> = 265 V ac	Power Factor	0.70		
V <sub>in</sub> = 120 V ac V <sub>out</sub> = 55 V	Efficiency (Use Actual Measured Data)	87%		

$$\text{Efficiency} = ((V_{\text{OUT}} \times I_{\text{OUT}}) / P_{\text{in}}) \times 100\%$$

### Step Dimming Test Procedure NCL30083BB1GEVB/NCL30083FLYGEVB

1. Connect the UUT to the LED load.
2. Apply 120 V ac power.
3. Verify that the output current is within the regulation limits as specified in the functional test procedure.
4. Interrupting the AC input for 1–2 s will step the output current down.
5. There 6 discrete current levels. After the lowest level, the current will return to maximum output.
6. Cycle the input power 6 times validating that the current steps down at each cycle and returns to maximum.

# NCL30083FLYGEVB, NCL30083BB1GEVB

## TEST DATA

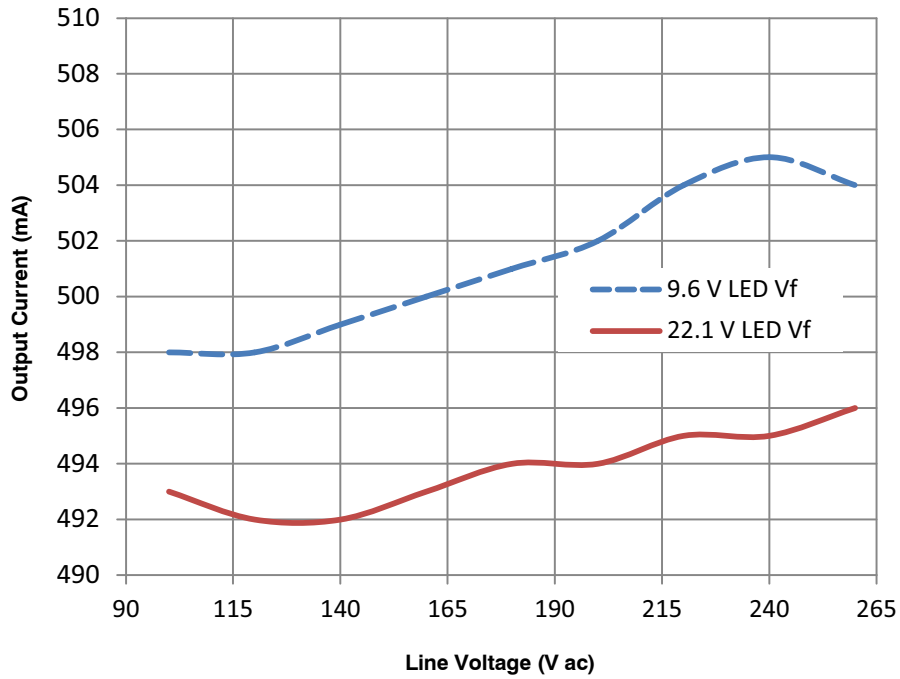

Figure 18. Flyback Line & Load Regulation

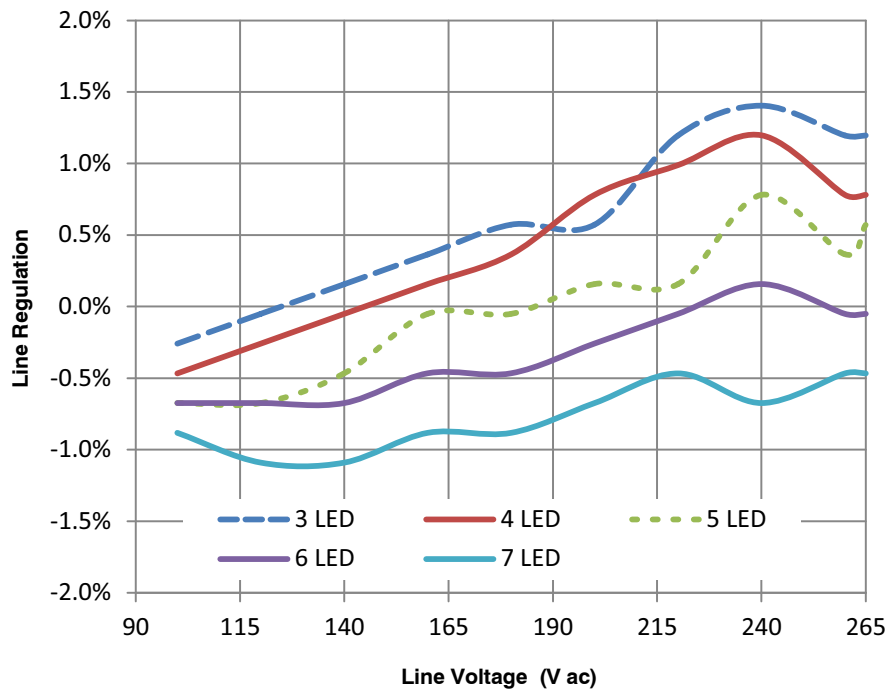

Figure 19. Flyback Relative Line Regulation

# NCL30083FLYGEVB, NCL30083BB1GEVB

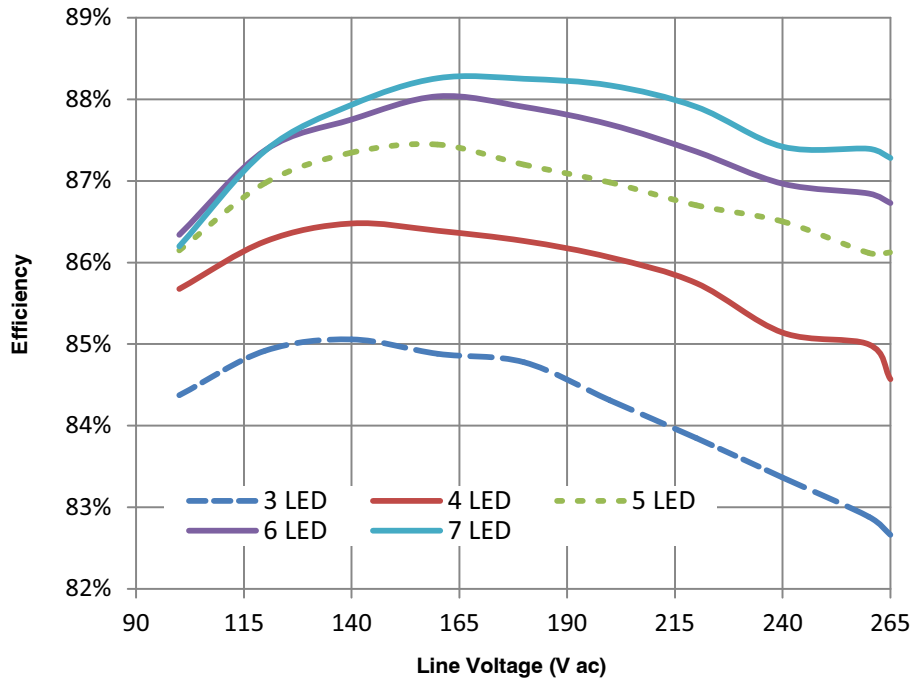

Figure 20. Flyback Line & Load Efficiency

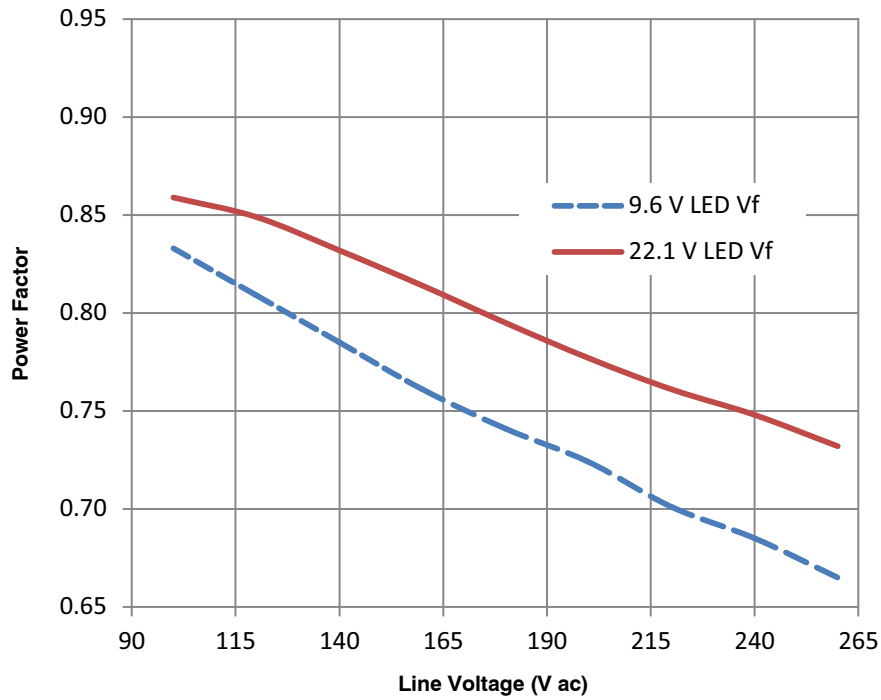

Figure 21. Flyback Line & Load Power Factor

NCL30083FLYGEVB, NCL30083BB1GEVB

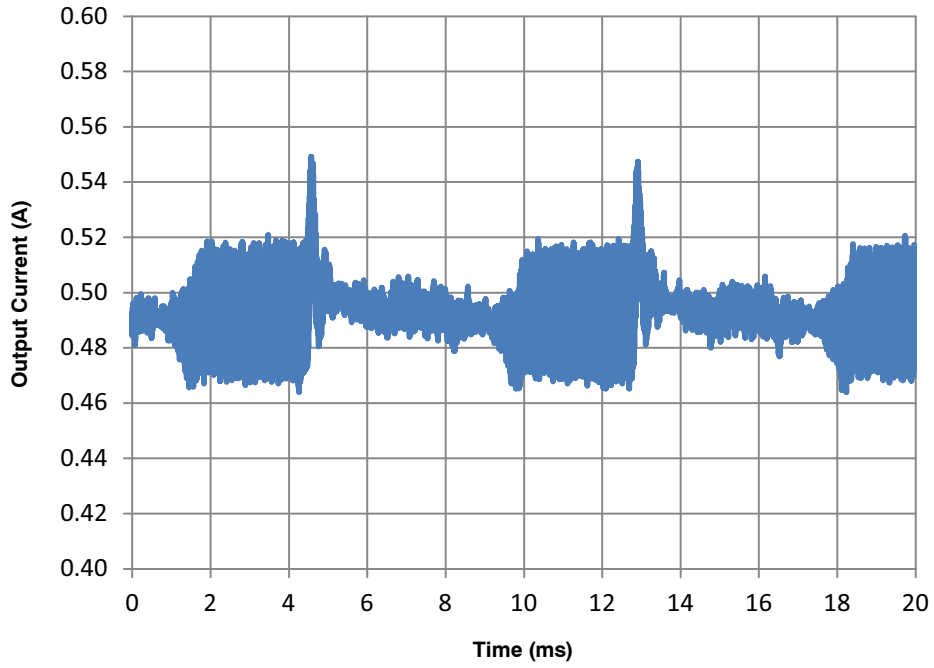

Figure 22. Flyback Output Ripple 120 V ac 60 Hz

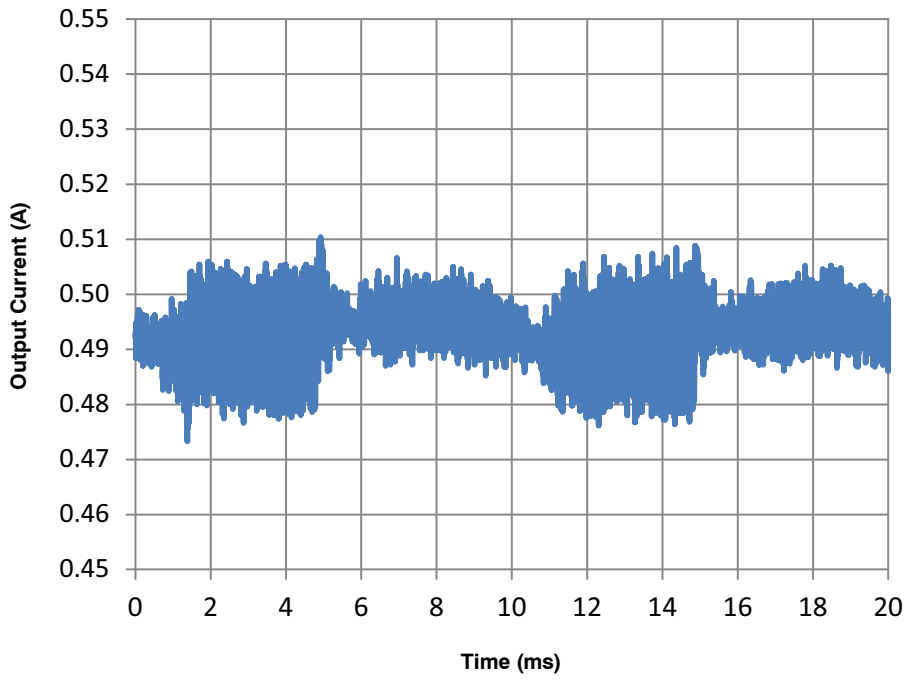

Figure 23. Flyback Output Ripple 230 V ac 50 Hz



# NCL30083FLYGEVB, NCL30083BB1GEVB

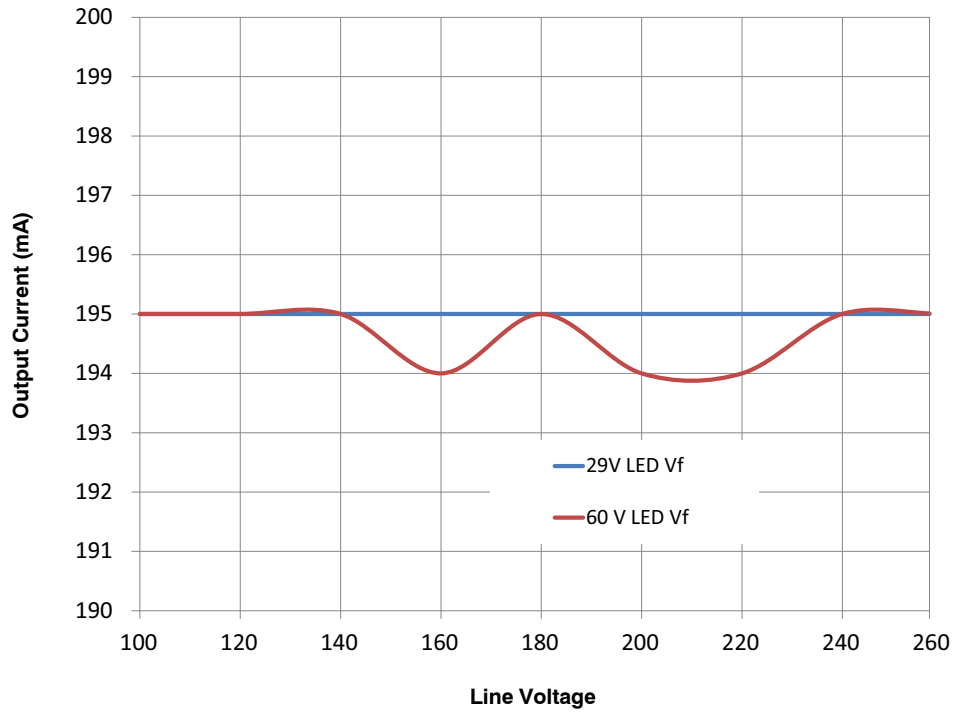

Figure 24. Buck Boost Line & Load Regulation

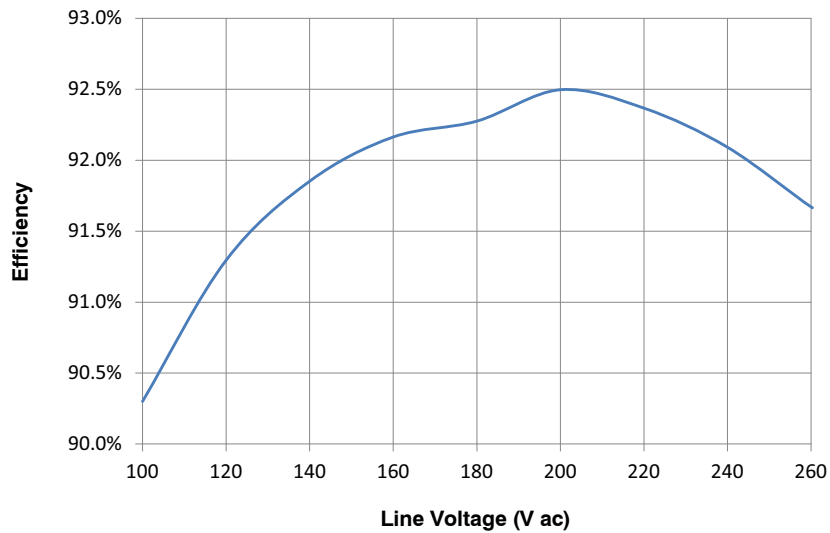

Figure 25. Buck Boost Efficiency over Line ( $V_1 = 55\text{ V}/I_{\text{out}} = 195\text{ mA}$ )

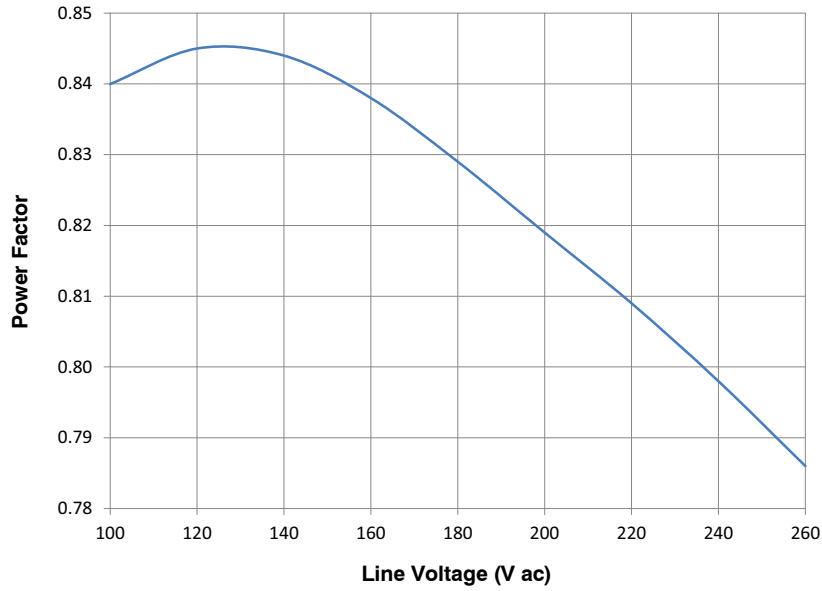

Figure 26. Buck Boost Power Factor over Line ( $V_1 = 55\text{ V}/I_{\text{out}} = 195\text{ mA}$ )

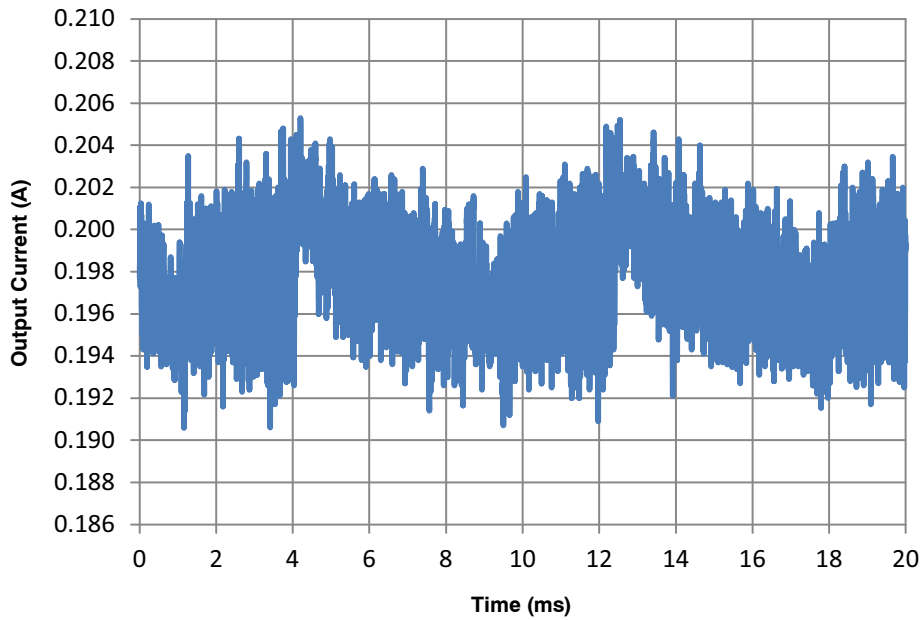

Figure 27. Buck Boost Output Ripple 120 V ac 60 Hz



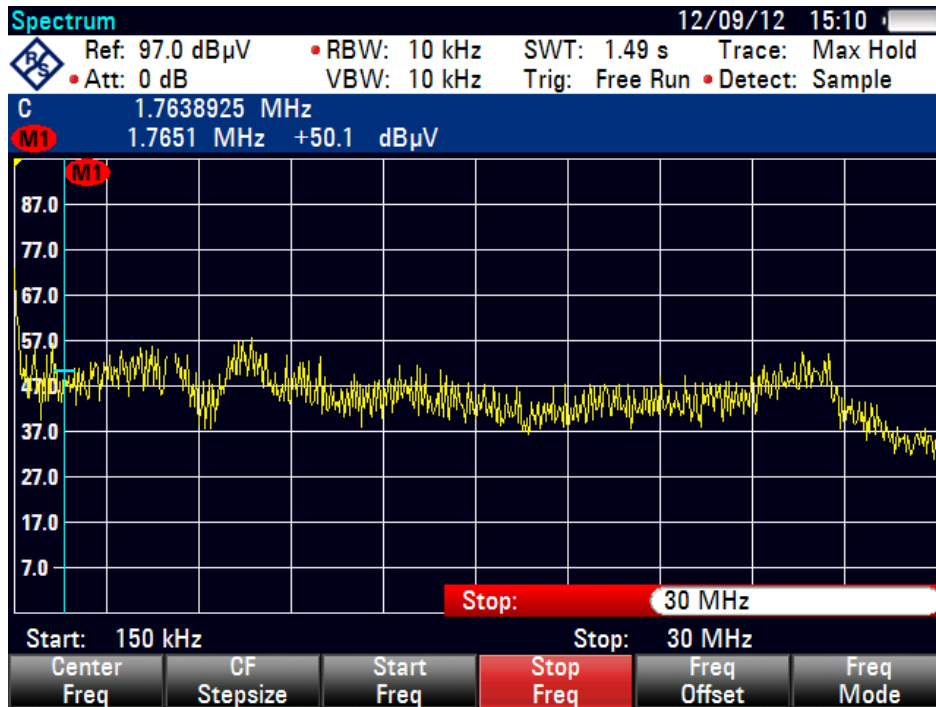

Figure 30. Conducted EMI Pre-compliance 150 kHz–30 MHz

## APPENDIX

### IEC61000–3–2 Class C Compliance

Compliance to IEC61000–3–2 Class C (under 25 W) is not possible with the valley fill front end architecture since input current does not comply with Class D requirements or the waveform definition requirements as stated in this excerpt.

*Active Input Power*  $\leq 25$  W:

Discharge lighting equipment having an active input power smaller than or equal to 25 W shall comply with one of the following two sets of requirements:

- The harmonic currents shall not exceed the power-related limits of Table 6, column 2, or:
- The third harmonic current, expressed as a percentage of the fundamental current, shall not exceed 86% and the fifth shall not exceed 61%; moreover, the waveform of the input current shall be such that it begins to flow before or at 60°, has its last peak (if there are several

peaks per half period) before or at 65° and does not stop flowing before 90°, where the zero crossing of the fundamental supply voltage is assumed to be at 0°.

If the discharge lighting equipment has a built-in dimming device, measurement is made only in the full load condition.

It is possible to comply with the special waveform and harmonic requirements of the third paragraph with a standard peak charge front end if the bulk capacitance is properly sized. The bulk capacitor must be in the range of 200–300 nF/W for a 230 V ac line for Europe. Japan has a similar requirement; however, the bulk capacitance must be 800–1,200 nF/W because the nominal main is 100 V ac rather than 230 V ac. The recommended capacitance values are line specific. So there is no universal mains solution with a peak charge front end. It is possible to convert the Evaluation Board from a valley fill to peak charge front end by deleting, changing, and shorting selected components.

## NCL30083FLYGEVB, NCL30083BB1GEVB

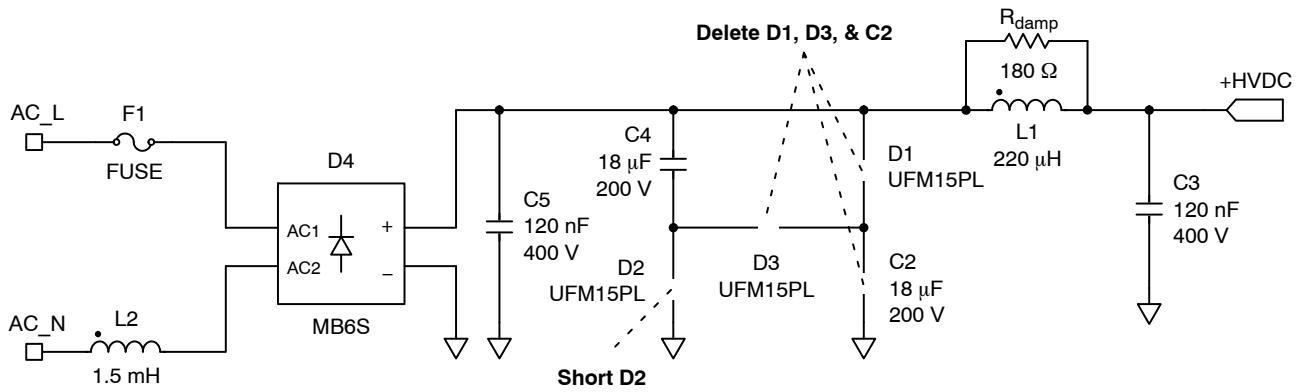

**Figure 31. Peak Charge Conversion for Evaluation Board**

**Table 6. BULK CAPACITOR SELECTION TABLE**

Line	Minimum Capacitance	Maximum Capacitance	Voltage Rating
230 V ac 50 Hz	2.2 $\mu$ F	3.3 $\mu$ F	400 V dc
100 V ac 50/60 Hz	8.2 $\mu$ F	12 $\mu$ F	200 V dc

NOTE: Capacitance values based on 10 W output and selected to the nearest standard value.

To illustrate Class C performance, an NCL30083FLYGEVB was modified and the input valley fill configuration was modified and the input bulk capacitor was changed to 2.2  $\mu$ F, this is the typical performance data.

Typical harmonic content is illustrated in Figure 34. For applications with 4 LEDs or less, the input capacitor value should be reduced to meet Class C harmonic content requirements.

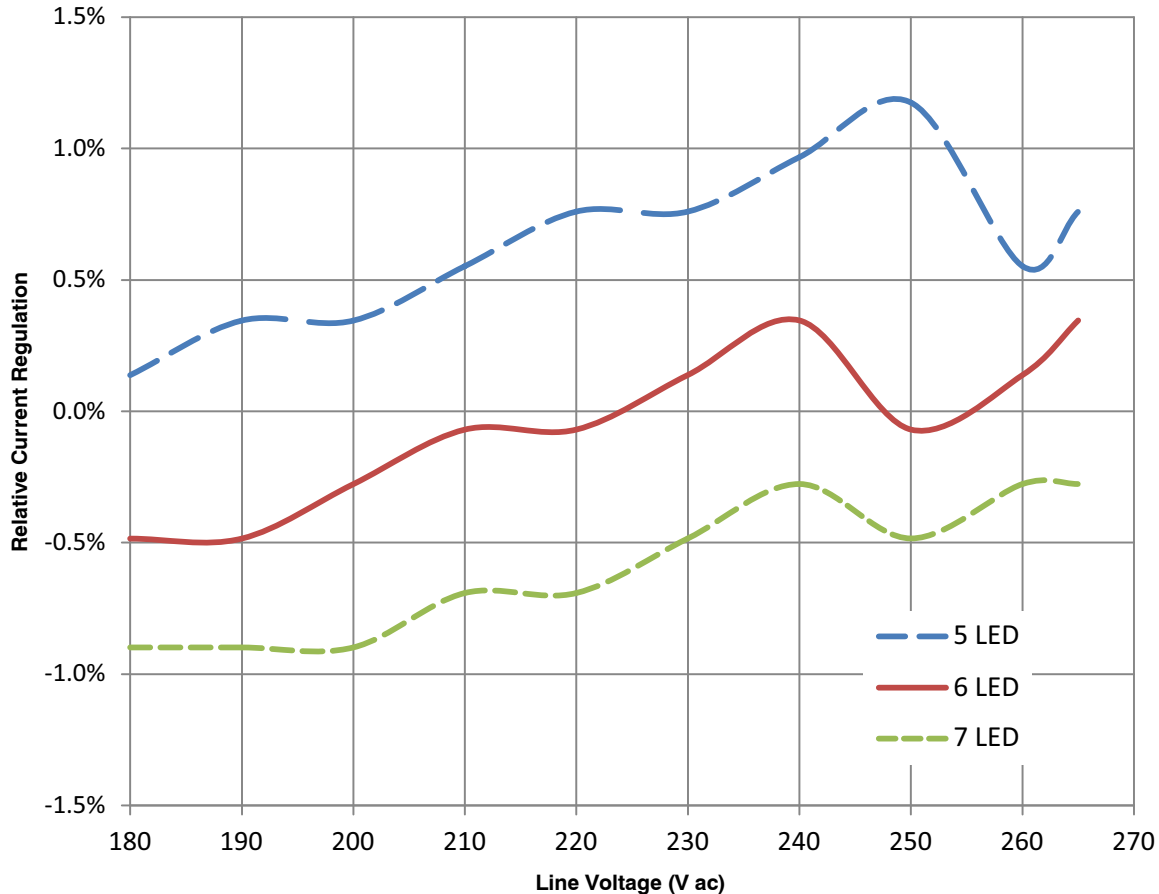

**Figure 32. 230 V ac, Class C – Flyback Relative Current Regulation**

## NCL30083FLYGEVB, NCL30083BB1GEVB

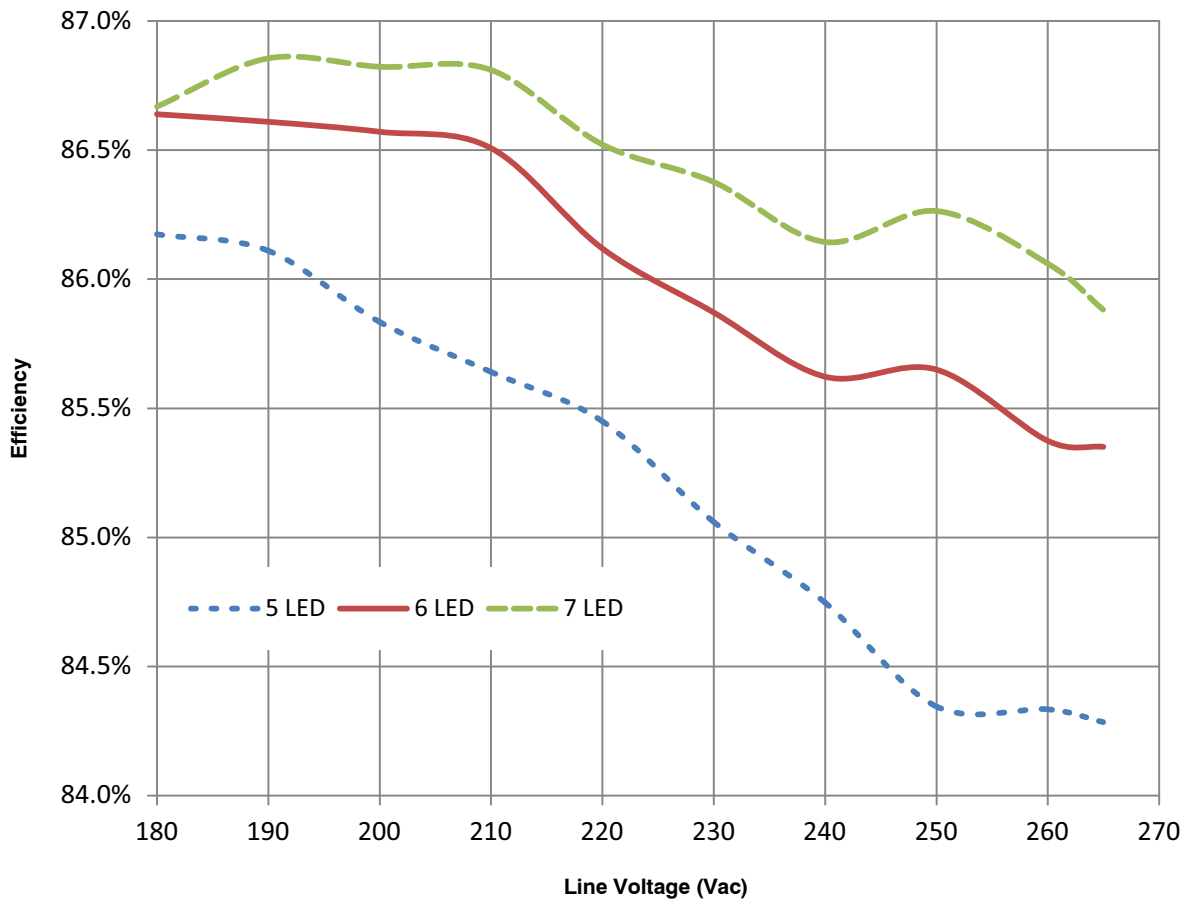

**Figure 33. 230 V ac, Class C – Flyback Line & Load Efficiency**

	Power Factor	3 <sup>rd</sup> Harmonic	5 <sup>th</sup> Harmonic
5 LED	0.575	81%	52.4%
6 LED	0.587	78%	47.0%
7 LED	0.59	74.6%	40.6%
Class C Limit	–	86%	61%

**Figure 34. Class C – Measured Harmonic Content.  $V_{in} = 230\text{ V ac}$ , 50 Hz**

c