

# Power Factor Corrected LED Driver with Primary Side CC/CV

## NCL30488

The NCL30488 is a power factor corrected flyback controller targeting isolated constant current LED drivers. The controller operates in a quasi-resonant mode to provide high efficiency. Thanks to a novel control method, the device is able to tightly regulate a constant LED current from the primary side. This removes the need for secondary side feedback circuitry, its biasing and for an optocoupler.

The device is highly integrated with a minimum number of external components. A robust suite of safety protection is built in to simplify the design.

### Features

- High Voltage Startup
- Quasi-resonant Peak Current-mode Control Operation
- Primary Side Feedback
- CC / CV Accurate Control  $V_{in}$  up to 320 V rms
- Tight LED Constant Current Regulation of  $\pm 2\%$  Typical
- Digital Power Factor Correction
- Analog and Digital Dimming
- Cycle by Cycle Peak Current Limit
- Wide Operating  $V_{CC}$  Range
- $-40$  to  $+125^{\circ}\text{C}$
- Robust Protection Features
  - ◆ Brown-Out
  - ◆ OVP on  $V_{CC}$
  - ◆ Constant Voltage / LED Open Circuit Protection
  - ◆ Winding Short Circuit Protection
  - ◆ Secondary Diode Short Protection
  - ◆ Output Short Circuit Protection
  - ◆ Thermal Shutdown
  - ◆ Line over Voltage Protection
- This is a Pb-Free Device

### Typical Applications

- Integral LED Bulbs
- LED Power Driver Supplies
- LED Light Engines



ON Semiconductor®

[www.onsemi.com](http://www.onsemi.com)



SOIC-7  
CASE 751U

### MARKING DIAGRAM

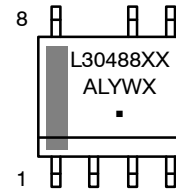

L30488 = Specific Device Code  
XX = Version  
A = Assembly Location  
L = Wafer Lot  
YW = Assembly Start Week  
▪ = Pb-Free Package

### PIN CONNECTIONS

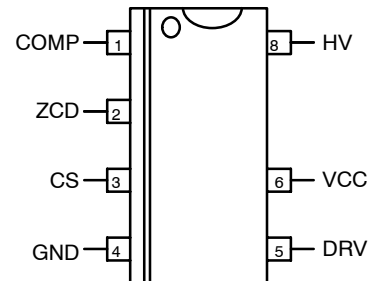

### ORDERING INFORMATION

See detailed ordering and shipping information on page 21 of this data sheet.

# NCL30488

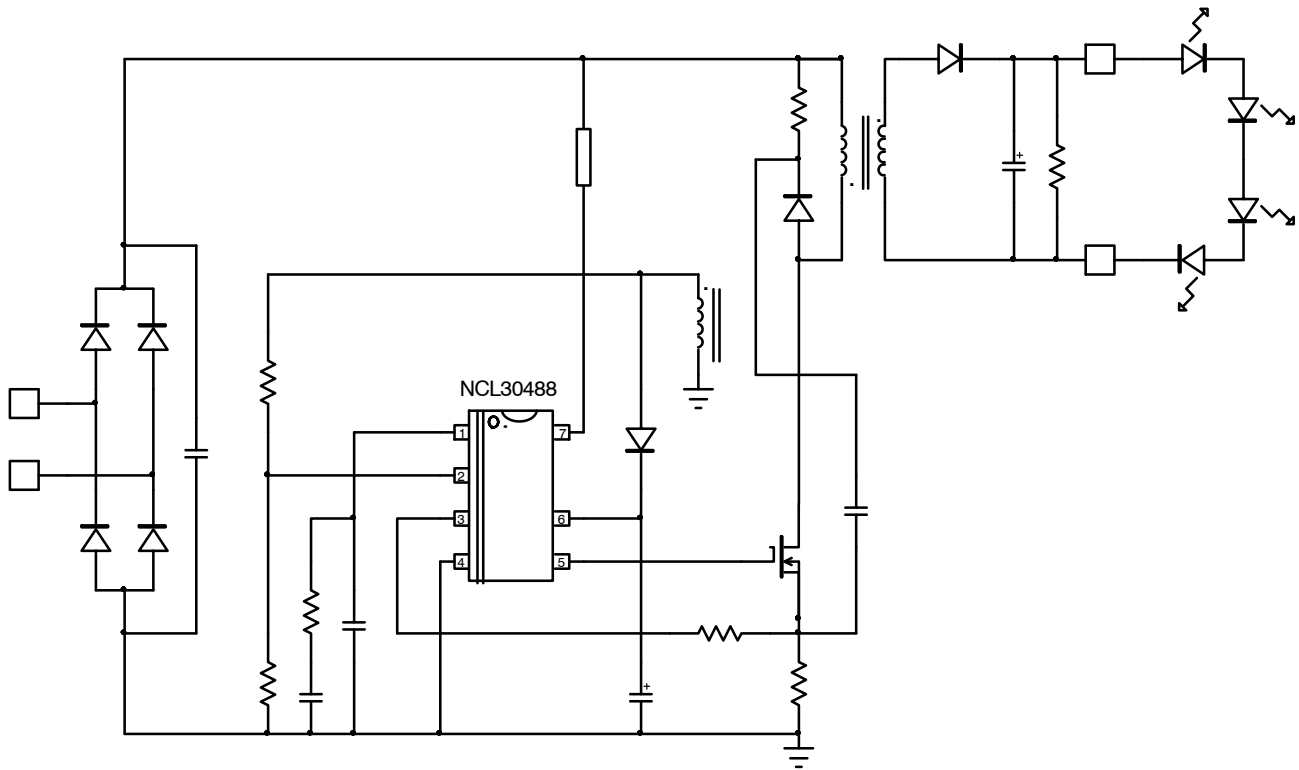

Figure 1. Typical Application Schematic for NCL30488

## PIN FUNCTION DESCRIPTION NCL30488

| Pin N° | Pin Name | Function                                     | Pin Description  |
|--------|----------|--|--|
| 1      | COMP     | OTA output for CV loop                       | This pin receives a compensation network (capacitors and resistors) to stabilize the CV loop   |
| 2      | ZCD      | Zero crossing Detection<br>$V_{aux}$ sensing | This pin connects to the auxiliary winding and is used to detect the core reset event. This pin also senses the auxiliary winding voltage for accurate output voltage control. |
| 3      | CS       | Current sense                                | This pin monitors the primary peak current.  |
| 4      | GND      | -  | The controller ground  |
| 5      | DRV      | Driver output                                | The driver's output to an external MOSFET  |
| 6      | VCC      | Supplies the controller                      | This pin is connected to an external auxiliary voltage.  |
| 7      | NC       | creepage                                     |  |
| 8      | HV       | High Voltage sensing                         | This pin connects after the diode bridge to provide the startup current and internal high voltage sensing function.  |

# NCL30488

## INTERNAL CIRCUIT ARCHITECTURE

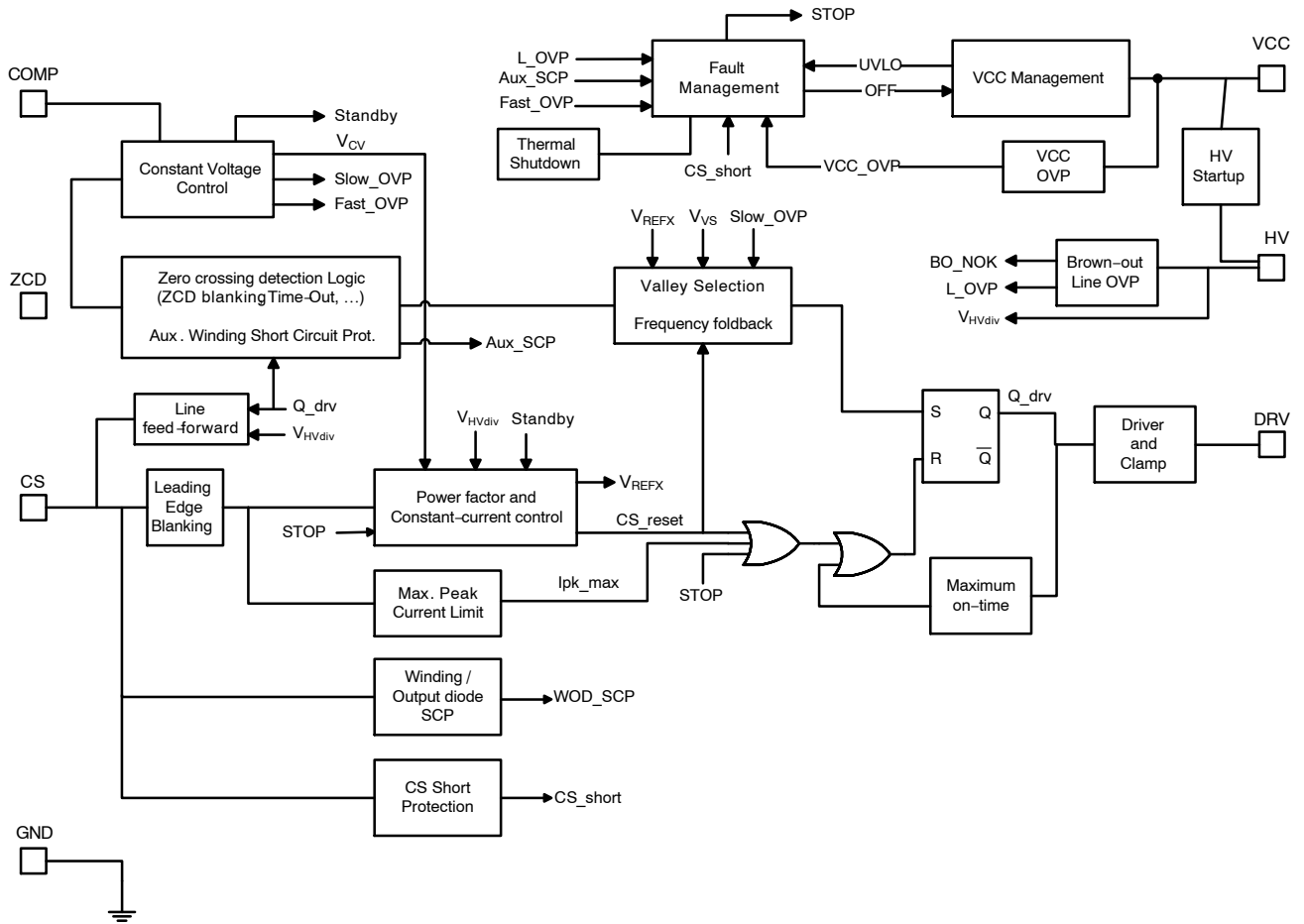

Figure 2. Internal Circuit Architecture NCL30488

**MAXIMUM RATINGS TABLE**

| Symbol   | Rating  | Value   | Unit    |
|--|---|---|---------|
| V <sub>CC(MAX)</sub><br>I <sub>CC(MAX)</sub>   | Maximum Power Supply voltage, VCC pin, continuous voltage<br>Maximum current for VCC pin                                  | -0.3 to 30<br>Internally limited              | V<br>mA |
| V <sub>DRV(MAX)</sub><br>I <sub>DRV(MAX)</sub> | Maximum driver pin voltage, DRV pin, continuous voltage<br>Maximum current for DRV pin                                    | -0.3, V <sub>DRV</sub> (Note 1)<br>-300, +500 | V<br>mA |
| V <sub>HV(MAX)</sub><br>I <sub>HV(MAX)</sub>   | Maximum voltage on HV pin<br>Maximum current for HV pin (dc current self-limited if operated within the allowed range)    | -0.3, +700<br>±20                             | V<br>mA |
| V <sub>MAX</sub><br>I <sub>MAX</sub>           | Maximum voltage on low power pins (except pins DRV and VCC)<br>Current range for low power pins (except pins DRV and VCC) | -0.3, 5.5 (Note 2)<br>-2, +5                  | V<br>mA |
| R <sub>θJ-A</sub>                              | Thermal Resistance Junction-to-Air  | 200   | °C/W    |
| T <sub>J(MAX)</sub>                            | Maximum Junction Temperature  | 150   | °C      |
|  | Operating Temperature Range   | -40 to +125                                   | °C      |
|  | Storage Temperature Range   | -60 to +150                                   | °C      |
|  | ESD Capability, HBM model except HV pin (Note 3)  | 4   | kV      |
|  | ESD Capability, HBM model HV pin  | 1.5   | kV      |
|  | ESD Capability, CDM model (Note 3)  | 1   | kV      |

Stresses exceeding those listed in the Maximum Ratings table may damage the device. If any of these limits are exceeded, device functionality should not be assumed, damage may occur and reliability may be affected.

- V<sub>DRV</sub> is the DRV clamp voltage V<sub>DRV(high)</sub> when V<sub>CC</sub> is higher than V<sub>DRV(high)</sub>. V<sub>DRV</sub> is V<sub>CC</sub> otherwise.
- This level is low enough to guarantee not to exceed the internal ESD diode and 5.5 V ZENER diode. More positive and negative voltages can be applied if the pin current stays within the -2 mA / 5 mA range.
- This device series contains ESD protection and exceeds the following tests: Human Body Model 4000 V per Mil-Std-883, Method 3015. Charged Device Model 1000 V per JEDEC Standard JESD22-C101D.
- This device contains latch-up protection and exceeds 100 mA per JEDEC Standard JESD78.

**ELECTRICAL CHARACTERISTICS** (Unless otherwise noted: For typical values T<sub>J</sub> = 25°C, V<sub>CC</sub> = 12 V, V<sub>ZCD</sub> = 0 V, V<sub>CS</sub> = 0 V)  
For min/max values T<sub>J</sub> = -40°C to +125°C, Max T<sub>J</sub> = 150°C, V<sub>CC</sub> = 12 V)

| Parameter | Test Condition | Symbol | Min | Typ | Max | Unit |
|-----------|----------------|--------|-----|-----|-----|------|
|-----------|----------------|--------|-----|-----|-----|------|

**HIGH VOLTAGE SECTION**

|   |  |                         |     |     |     |       |
|---|--|-------------------------|-----|-----|-----|-------|
| High voltage current source   | V <sub>CC</sub> = V <sub>CC(on)</sub> - 200 mV | I <sub>HV(start2)</sub> | 3.9 | 5.1 | 6.2 | mA    |
| High voltage current source   | V <sub>CC</sub> = 0 V                          | I <sub>HV(start1)</sub> | -   | 300 | -   | µA    |
| V <sub>CC</sub> level for I <sub>HV(start1)</sub> to I <sub>HV(start2)</sub> transition |  | V <sub>CC(TH)</sub>     | -   | 0.8 | -   | V     |
| Minimum startup voltage   | V <sub>CC</sub> = 0 V                          | V <sub>HV(MIN)</sub>    | -   | 15  | -   | V     |
| HV source leakage current   | V <sub>HV</sub> = 450 V                        | I <sub>HV(leak)</sub>   | -   | 4.5 | 10  | µA    |
| Maximum input voltage (rms) for correct operation of the PFC loop                       |  | V <sub>HV(OL)</sub>     | 320 | -   | -   | V rms |

**SUPPLY SECTION**

|   |  |   |                       |                           |                           |        |    |
|---|--|---|-----------------------|---------------------------|---------------------------|--------|----|
| Supply Voltage<br>Startup Threshold<br>Minimum Operating Voltage<br>Hysteresis V <sub>CC(on)</sub> - V <sub>CC(off)</sub><br>Internal logic reset                               | V <sub>CC</sub> increasing<br>V <sub>CC</sub> decreasing<br>V <sub>CC</sub> decreasing   | V <sub>CC(on)</sub><br>V <sub>CC(off)</sub><br>V <sub>CC(HYS)</sub><br>V <sub>CC(reset)</sub> | 16<br>9.3<br>7.6<br>4 | 18<br>10.2<br>-           | 20<br>10.7<br>-           | 6<br>- | V  |
| Over Voltage Protection<br>VCC OVP threshold  |  | V <sub>CC(OVP)</sub>  | 25                    | 26.5                      | 28                        | -      | V  |
| V <sub>CC(off)</sub> noise filter (Note 5)<br>V <sub>CC(reset)</sub> noise filter (Note 5)  |  | t <sub>VCC(off)</sub><br>t <sub>VCC(reset)</sub>  | -<br>-                | 5<br>20                   | -<br>-                    | -      | µs |
| Supply Current<br>Device Disabled/Fault<br>Device Enabled/No output load on pin 5<br>Device Switching (F <sub>sw</sub> = 65 kHz)<br>Device switching (F <sub>sw</sub> = 700 Hz) | V <sub>CC</sub> > V <sub>CC(off)</sub><br>F <sub>sw</sub> = 65 kHz<br>C <sub>DRV</sub> = 470 pF, F <sub>sw</sub> = 65 kHz<br>V <sub>COMP</sub> ≤ 0.9 V | I <sub>CC1</sub><br>I <sub>CC2</sub><br>I <sub>CC3</sub><br>I <sub>CC4</sub>                  | 1.2<br>-<br>-<br>-    | 1.35<br>3.0<br>3.5<br>1.7 | 1.6<br>3.5<br>4.0<br>1.88 | -      | mA |

# NCL30488

**ELECTRICAL CHARACTERISTICS** (Unless otherwise noted: For typical values  $T_J = 25^\circ\text{C}$ ,  $V_{CC} = 12\text{ V}$ ,  $V_{ZCD} = 0\text{ V}$ ,  $V_{CS} = 0\text{ V}$ )  
For min/max values  $T_J = -40^\circ\text{C}$  to  $+125^\circ\text{C}$ , Max  $T_J = 150^\circ\text{C}$ ,  $V_{CC} = 12\text{ V}$ ) (continued)

| Parameter  | Test Condition   | Symbol                 | Min    | Typ        | Max    | Unit             |
|--|--|------------------------|--------|------------|--------|------------------|
| <b>CURRENT SENSE</b>   |  |                        |        |            |        |                  |
| Maximum Internal current limit   |  | $V_{ILIM}$             | 1.33   | 1.40       | 1.47   | V                |
| Leading Edge Blanking Duration for $V_{ILIM}$                                      |  | $t_{LEB}$              | 283    | 345        | 407    | ns               |
| Propagation delay from current detection to gate off-state                         |  | $t_{LIM}$              | -      | 100        | 150    | ns               |
| Maximum on-time (option 1)   |  | $t_{on(MAX)}$          | 29     | 39         | 49     | $\mu\text{s}$    |
| Maximum on-time (option 2)   |  | $t_{on(MAX)}$          | 16     | 20         | 24     | $\mu\text{s}$    |
| Threshold for immediate fault protection activation (140% of $V_{ILIM}$ )          |  | $V_{CS(stop)}$         | 1.9    | 2.0        | 2.1    | V                |
| Leading Edge Blanking Duration for $V_{CS(stop)}$                                  |  | $t_{BCS}$              | -      | 170        | -      | ns               |
| Current source for CS to GND short detection                                       |  | $I_{CS(short)}$        | 400    | 500        | 600    | $\mu\text{A}$    |
| Current sense threshold for CS to GND short detection                              | $V_{CS}$ rising  | $V_{CS(low)}$          | 20     | 60         | 90     | mV               |
| <b>GATE DRIVE</b>  |  |                        |        |            |        |                  |
| Drive Resistance<br>DRV Sink<br>DRV Source   |  | $R_{SNK}$<br>$R_{SRC}$ | -<br>- | 13<br>30   | -<br>- | $\Omega$         |
| Drive current capability<br>DRV Sink (Note GBD)<br>DRV Source (Note GBD)           |  | $I_{SNK}$<br>$I_{SRC}$ | -<br>- | 500<br>300 | -<br>- | mA               |
| Rise Time (10% to 90%)   | $C_{DRV} = 470\text{ pF}$  | $t_r$                  | -      | 30         | -      | ns               |
| Fall Time (90% to 10%)   | $C_{DRV} = 470\text{ pF}$  | $t_f$                  | -      | 20         | -      | ns               |
| DRV Low Voltage  | $V_{CC} = V_{CC(off)} + 0.2\text{ V}$<br>$C_{DRV} = 470\text{ pF}$ , $R_{DRV} = 33\text{ k}\Omega$ | $V_{DRV(low)}$         | 8      | -          | -      | V                |
| DRV High Voltage   | $V_{CC} = V_{CC(MAX)}$<br>$C_{DRV} = 470\text{ pF}$ , $R_{DRV} = 33\text{ k}\Omega$                | $V_{DRV(high)}$        | 10     | 12         | 14     | V                |
| <b>ZERO VOLTAGE DETECTION CIRCUIT</b>  |  |                        |        |            |        |                  |
| Upper ZCD threshold voltage  | $V_{ZCD}$ rising   | $V_{ZCD(rising)}$      | -      | 90         | 150    | mV               |
| Lower ZCD threshold voltage  | $V_{ZCD}$ falling  | $V_{ZCD(falling)}$     | 35     | 55         | -      | mV               |
| Threshold to force $V_{REFX}$ maximum during startup                               | $V_{ZCD}$ falling  | $V_{ZCD(start)}$       | -      | 0.7        | -      | V                |
| ZCD hysteresis   |  | $V_{ZCD(HYS)}$         | 15     | -          | -      | mV               |
| Propagation Delay from valley detection to DRV high (no $t_{LEB4}$ )               | $V_{ZCD}$ decreasing   | $t_{ZCD(DEM)}$         | -      | -          | 150    | ns               |
| Additional delay from valley lockout output to DRV latch set (programmable option) | $V_{ZCD}$ decreasing   | $T_{LEB4}$             | 125    | 250        | 375    | ns               |
| Equivalent time constant for ZCD input (GBD)                                       |  | $t_{PAR}$              | -      | 20         | -      | ns               |
| Blanking delay after on-time (option 1)  | $V_{REFX} > 0.35\text{ V}$   | $t_{ZCD(blank1)}$      | 1.1    | 1.5        | 1.9    | $\mu\text{s}$    |
| Blanking delay after on-time (option 2)  | $V_{REFX} > 0.35\text{ V}$   | $t_{ZCD(blank1)}$      | 0.75   | 1.0        | 1.25   | $\mu\text{s}$    |
| Blanking Delay at light load (option 1)  | $V_{REFX} < 0.25\text{ V}$   | $t_{ZCD(blank2)}$      | 0.6    | 0.8        | 1.0    | $\mu\text{s}$    |
| Blanking Delay at light load (option 2)  | $V_{REFX} < 0.25\text{ V}$   | $t_{ZCD(blank2)}$      | 0.45   | 0.6        | 0.75   | $\mu\text{s}$    |
| Timeout after last DEMAG transition  |  | $t_{TIMO}$             | 5      | 6.5        | 8      | $\mu\text{s}$    |
| Pulling-down resistor  | $V_{ZCD} = V_{ZCD(falling)}$   | $R_{ZCD(pd)}$          | -      | 200        | -      | $\text{k}\Omega$ |
| <b>CONSTANT CURRENT CONTROL</b>  |  |                        |        |            |        |                  |
| Reference Voltage  | $T_J = 25^\circ\text{C} - 85^\circ\text{C}$  | $V_{REF/3}$            | 327.9  | 334.2      | 341.2  | mV               |
| Reference Voltage  | $T_J = -40^\circ\text{C}$ to $125^\circ\text{C}$   | $V_{REF/3}$            | 324    | 334.2      | 346    | mV               |
| Current sense lower threshold for detection of the leakage inductance reset time   | $V_{CS}$ falling   | $V_{CS(low)}$          | 20     | 50         | 100    | mV               |
| Blanking time for leakage inductance reset detection                               |  | $t_{CS(low)}$          | -      | 120        | -      | ns               |

# NCL30488

**ELECTRICAL CHARACTERISTICS** (Unless otherwise noted: For typical values  $T_J = 25^\circ\text{C}$ ,  $V_{CC} = 12\text{ V}$ ,  $V_{ZCD} = 0\text{ V}$ ,  $V_{CS} = 0\text{ V}$ )  
For min/max values  $T_J = -40^\circ\text{C}$  to  $+125^\circ\text{C}$ , Max  $T_J = 150^\circ\text{C}$ ,  $V_{CC} = 12\text{ V}$ ) (continued)

| Parameter | Test Condition | Symbol | Min | Typ | Max | Unit |
|-----------|----------------|--------|-----|-----|-----|------|
|-----------|----------------|--------|-----|-----|-----|------|

## POWER FACTOR CORRECTION

|                                   |  |                   |      |     |      |     |
|-----------------------------------|--|-------------------|------|-----|------|-----|
| Clamping value for $V_{REF(PFC)}$ | $T_J = 0^\circ\text{C}$ to $125^\circ\text{C}$ | $V_{REF(PFC)CLP}$ | 2.06 | 2.2 | 2.34 | V   |
| Line range detector for PFC loop  | $V_{HV}$ increases                             | $V_{HL(PFC)}$     | -    | 240 | -    | Vdc |
| Line range detector for PFC loop  | $V_{HV}$ decreases                             | $V_{LL(PFC)}$     | -    | 230 | -    | Vdc |

## CONSTANT VOLTAGE SECTION

|  |  |                    |       |           |       |                  |
|--|--|--------------------|-------|-----------|-------|------------------|
| Internal voltage reference for constant voltage regulation |  | $V_{REF(CV)}$      | 3.41  | 3.52      | 3.63  | V                |
| CV Error amplifier Gain                                    |  | $G_{EA}$           | 40    | 50        | 60    | $\mu\text{S}$    |
| Error amplifier current capability                         | $V_{REFX} = V_{REF}$ (no dimming)                | $I_{EA}$           | -     | $\pm 60$  | -     | $\mu\text{A}$    |
| COMP pin lower clamp voltage                               |  | $V_{CV(clampL)}$   | -     | 0.6       | -     | V                |
| COMP pin higher clamp voltage                              | $T_J = 0^\circ\text{C}$ to $125^\circ\text{C}$   | $V_{CV(clampH)}$   | 4.05  | 4.12      | 4.25  | V                |
| COMP pin higher clamp voltage                              | $T_J = -40^\circ\text{C}$ to $125^\circ\text{C}$ | $V_{CV(clampH)}$   | 4.01  | 4.12      | 4.25  | V                |
| Internal divider $V_{COMP}$ to $V_{REFX}$                  |  | $K_{COMP}$         | -     | 4         | -     |                  |
| Internal ZCD voltage below which the CV OTA is boosted     | $V_{REF(CV)} * 85\%$                             | $V_{boost(CV)}$    | 2.796 | 2.975     | 3.154 | V                |
| Threshold for releasing the CV boost                       | $V_{REF(CV)} * 90\%$                             | $V_{boost(CV)RST}$ | 2.96  | 3.15      | 3.34  | V                |
| Error amplifier current capability during boost phase      |  | $I_{EAboost}$      | -     | $\pm 140$ | -     | $\mu\text{A}$    |
| ZCD OVP 1 <sup>st</sup> level (slow OVP) option 1          | $V_{REF(CV)} * 115\%$                            | $V_{OVP1}$         | 3.783 | 4.025     | 4.267 | V                |
| ZCD voltage at which slow OVP is exit (option 1)           | $V_{REF(CV)} * 105\%$                            | $V_{OVP1rst}$      | -     | 3.675     | -     | V                |
| Switching period during slow OVP                           |  | $T_{sw(OVP1)}$     | -     | 1.5       | -     | ms               |
| ZCD fast OVP option 1                                      | $V_{ref(CV)} * 125\% + 150\text{ mV}$            | $V_{OVP2}$         | 4.253 | 4.525     | 4.797 | V                |
| Number of switching cycles before fast OVP confirmation    |  | $T_{OVP2\_CNT}$    | -     | 4         | -     |                  |
| Duration for disabling DRV pulses during ZCD fast OVP      |  | $T_{recovery}$     | -     | 4         | -     | s                |
| COMP pin internal pullup resistor (SSR option)             |  | $R_{pullup}$       | -     | 15        | -     | $\text{k}\Omega$ |

## LINE FEED FORWARD

|   |  |                   |       |      |       |                 |
|---|--|-------------------|-------|------|-------|-----------------|
| $V_{HV}$ to $I_{CS(offset)}$ conversion ratio |  | $K_{LFF}$         | 0.189 | 0.21 | 0.231 | $\mu\text{A/V}$ |
| Offset current maximum value                  | $V_{HV} > (450\text{ V or } 500\text{ V})$ | $I_{offset(MAX)}$ | 76    | 95   | 114   | $\mu\text{A}$   |
| Line feed-forward current                     | DRV high, $V_{HV} = 200\text{ V}$          | $I_{FF}$          | 35    | 40   | 45    | $\mu\text{A}$   |

## VALLEY LOCKOUT SECTION

|   |                    |                 |     |     |     |    |
|---|--------------------|-----------------|-----|-----|-----|----|
| Threshold for line range detection $V_{HV}$ increasing (1 <sup>st</sup> to 2 <sup>nd</sup> valley transition for $V_{REFX} > 80\% V_{REF}$ ) (prog. option: 1 <sup>st</sup> to 3 <sup>rd</sup> valley transition) | $V_{HV}$ increases | $V_{HL}$        | 228 | 240 | 252 | V  |
| Threshold for line range detection $V_{HV}$ decreasing (2 <sup>nd</sup> to 1 <sup>st</sup> valley transition for $V_{REFX} > 80\% V_{REF}$ ) (prog. option: 3 <sup>rd</sup> to 1 <sup>st</sup> valley transition) | $V_{HV}$ decreases | $V_{LL}$        | 218 | 230 | 242 | V  |
| Blanking time for line range detection  |                    | $t_{HL(blank)}$ | 15  | 25  | 35  | ms |

# NCL30488

**ELECTRICAL CHARACTERISTICS** (Unless otherwise noted: For typical values  $T_J = 25^\circ\text{C}$ ,  $V_{CC} = 12\text{ V}$ ,  $V_{ZCD} = 0\text{ V}$ ,  $V_{CS} = 0\text{ V}$ )  
For min/max values  $T_J = -40^\circ\text{C}$  to  $+125^\circ\text{C}$ , Max  $T_J = 150^\circ\text{C}$ ,  $V_{CC} = 12\text{ V}$ ) (continued)

| Parameter | Test Condition | Symbol | Min | Typ | Max | Unit |
|-----------|----------------|--------|-----|-----|-----|------|
|-----------|----------------|--------|-----|-----|-----|------|

## VALLEY LOCKOUT SECTION

|   |                     |                  |   |      |   |   |
|---|---------------------|------------------|---|------|---|---|
| Valley thresholds   |                     |                  |   |      |   | V |
| 1 <sup>st</sup> to 2 <sup>nd</sup> valley transition at LL and 2 <sup>nd</sup> to 3 <sup>rd</sup> valley HL, $V_{REF}$ decr. (prog. option: 3 <sup>rd</sup> to 4 <sup>th</sup> valley HL) | $V_{REF}$ decreases | $V_{VLY1-2/2-3}$ | - | 0.80 | - |   |
| 2 <sup>nd</sup> to 1 <sup>st</sup> valley transition at LL and 3 <sup>rd</sup> to 2 <sup>nd</sup> valley HL, $V_{REF}$ incr. (prog. option: 4 <sup>th</sup> to 3 <sup>rd</sup> valley HL) | $V_{REF}$ increases | $V_{VLY2-1/3-2}$ | - | 0.90 | - |   |
| 2 <sup>nd</sup> to 3 <sup>rd</sup> valley transition at LL and 3 <sup>rd</sup> to 4 <sup>th</sup> valley HL, $V_{REF}$ decr. (prog. option: 4 <sup>th</sup> to 5 <sup>th</sup> valley HL) | $V_{REF}$ decreases | $V_{VLY2-3/3-4}$ | - | 0.65 | - |   |
| 3 <sup>rd</sup> to 2 <sup>nd</sup> valley transition at LL and 4 <sup>th</sup> to 3 <sup>rd</sup> valley HL, $V_{REF}$ incr. (prog. option: 5 <sup>th</sup> to 4 <sup>th</sup> valley HL) | $V_{REF}$ increases | $V_{VLY3-2/4-3}$ | - | 0.75 | - |   |
| 3 <sup>rd</sup> to 4 <sup>th</sup> valley transition at LL and 4 <sup>th</sup> to 5 <sup>th</sup> valley HL, $V_{REF}$ decr. (prog. option: 5 <sup>th</sup> to 6 <sup>th</sup> valley HL) | $V_{REF}$ decreases | $V_{VLY3-4/4-5}$ | - | 0.50 | - |   |
| 4 <sup>th</sup> to 3 <sup>rd</sup> valley transition at LL and 5 <sup>th</sup> to 4 <sup>th</sup> valley HL, $V_{REF}$ incr. (prog. option: 6 <sup>th</sup> to 5 <sup>th</sup> valley HL) | $V_{REF}$ increases | $V_{VLY4-3/5-4}$ | - | 0.60 | - |   |
| 4 <sup>th</sup> to 5 <sup>th</sup> valley transition at LL and 5 <sup>th</sup> to 6 <sup>th</sup> valley HL, $V_{REF}$ decr. (prog. option: 6 <sup>th</sup> to 7 <sup>th</sup> valley HL) | $V_{REF}$ decreases | $V_{VLY4-5/5-6}$ | - | 0.35 | - |   |
| 5 <sup>th</sup> to 4 <sup>th</sup> valley transition at LL and 6 <sup>th</sup> to 5 <sup>th</sup> valley HL, $V_{REF}$ incr. (prog. option: 7 <sup>th</sup> to 6 <sup>th</sup> valley HL) | $V_{REF}$ increases | $V_{VLY5-4/6-5}$ | - | 0.45 | - |   |
| $V_{REF}$ value at which the FF mode is activated   | $V_{REF}$ decreases | $V_{FFstart}$    | - | 0.25 | - | V |
| $V_{REF}$ value at which the FF mode is removed   | $V_{REF}$ increases | $V_{FFstop}$     | - | 0.35 | - | V |

## FREQUENCY FOLDBACK

|   |  |                   |     |     |     |               |
|---|--|-------------------|-----|-----|-----|---------------|
| Added dead time                               | $V_{REFX} = 0.25\text{ V}$                 | $t_{FF1LL}$       | 0.8 | 1.0 | 1.2 | $\mu\text{s}$ |
| Added dead time                               | $V_{REFX} = 0.08\text{ V}$                 | $t_{FFchg}$       | -   | 40  | -   | $\mu\text{s}$ |
| Dead-time clamp (option 1)                    | $V_{REFX} < 3\text{ mV}$                   | $t_{FFend1}$      | -   | 675 | -   | $\mu\text{s}$ |
| Dead-time clamp (option 2)                    | $V_{REFX} < 11.2\text{ mV}$                | $t_{FFend2}$      | -   | 250 | -   | $\mu\text{s}$ |
| Minimum added dead-time in standby            | $V_{REFX} = 0$                             | $t_{DT(min)SBY}$  | -   | 650 | -   | $\mu\text{s}$ |
| Maximum added dead-time in standby (option 2) | $V_{REFX} = 0$ , $V_{COMP} < 0.7\text{ V}$ | $t_{DT(max)SBY2}$ | -   | 1.8 | -   | ms            |

## FAULT PROTECTION

|  |  |                   |     |      |     |                  |
|--|--|-------------------|-----|------|-----|------------------|
| Thermal Shutdown (Note 5)  | Device switching ( $F_{SW}$ around 65 kHz) | $T_{SHDN}$        | 130 | 150  | 170 | $^\circ\text{C}$ |
| Thermal Shutdown Hysteresis  |  | $T_{SHDN(HYS)}$   | -   | 20   | -   | $^\circ\text{C}$ |
| Threshold voltage for output short circuit or aux. winding short circuit detection |  | $V_{ZCD(short)}$  | 0.6 | 0.65 | 0.7 | V                |
| Short circuit detection Timer  | $V_{ZCD} < V_{ZCD(short)}$                 | $t_{OVLd}$        | 70  | 90   | 110 | ms               |
| Auto-recovery Timer  |  | $t_{recovery}$    | 3   | 4    | 5   | s                |
| Line OVP threshold   | $V_{HV}$ increasing                        | $V_{HV(OVP)}$     | 457 | 469  | 485 | Vdc              |
| HV pin voltage at which Line OVP is reset  | $V_{HV}$ decreasing                        | $V_{HV(OVP)RST}$  | 430 | 443  | 465 | Vdc              |
| Blanking time for line OVP reset   |  | $T_{LOVP(blank)}$ | 15  | 25   | 35  | ms               |

## BROWN-OUT AND LINE SENSING

|  |                               |                  |       |     |       |               |
|--|-------------------------------|------------------|-------|-----|-------|---------------|
| Brown-Out ON level (IC start pulsing)                              | $V_{HV}$ increasing           | $V_{HVBO(on)}$   | 101.5 | 108 | 114.5 | Vdc           |
| Brown-Out ON level (IC start pulsing) option 2                     | $V_{HV}$ increasing           | $V_{HVBO(on)2}$  | 129.7 | 138 | 146.3 | Vdc           |
| Brown-Out OFF level (IC stops pulsing)                             | $V_{HV}$ decreasing           | $V_{HVBO(off)}$  | 92    | 98  | 104   | Vdc           |
| Brown-Out OFF level (IC stops pulsing) option 2                    | $V_{HV}$ decreasing           | $V_{HVBO(off)2}$ | 121   | 129 | 137   | Vdc           |
| HV pin voltage above which the sampling of ZCD is enabled low line | $V_{HV}$ decreasing, low line | $V_{sampENLL}$   | -     | 55  | -     | V             |
| HV pin voltage above which the sampling of ZCD is enabled highline | $V_{HV}$ decreasing, highline | $V_{sampENHL}$   | -     | 105 | -     | V             |
| ZCD sampling enable comparator hysteresis                          | $V_{HV}$ increasing           | $V_{sampHYS}$    | -     | 5   | -     | V             |
| BO comparators delay   |                               | $t_{BO(delay)}$  | -     | 30  | -     | $\mu\text{s}$ |
| Brown-Out blanking time  |                               | $t_{BO(blank)}$  | 15    | 25  | 35    | ms            |

Product parametric performance is indicated in the Electrical Characteristics for the listed test conditions, unless otherwise noted. Product performance may not be indicated by the Electrical Characteristics if operated under different conditions.

5. Guaranteed by design.

TYPICAL CHARACTERISTICS

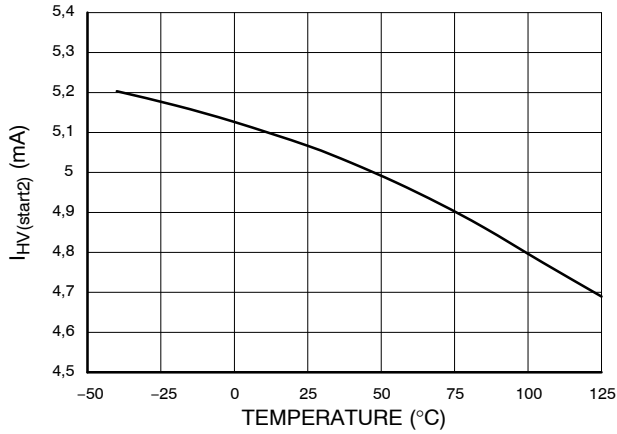

Figure 3.  $I_{HV(start2)}$  vs. Temperature

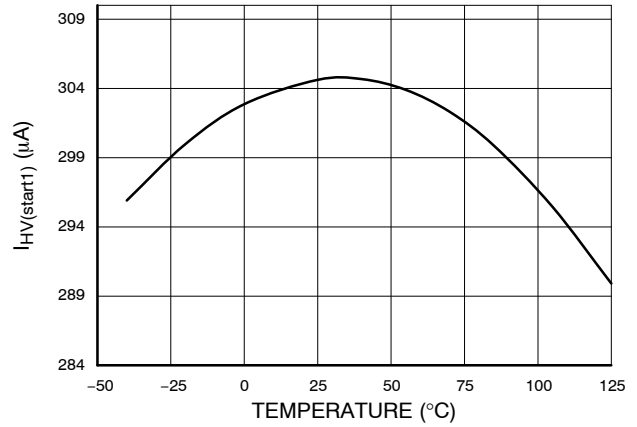

Figure 4.  $I_{HV(start1)}$  vs. Temperature

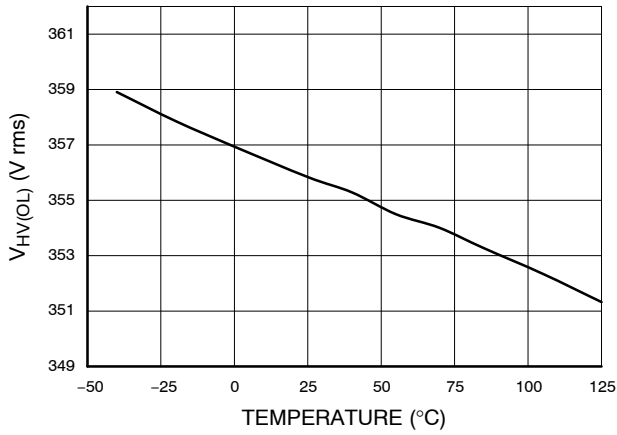

Figure 5.  $V_{HV(OL)}$  vs. Temperature

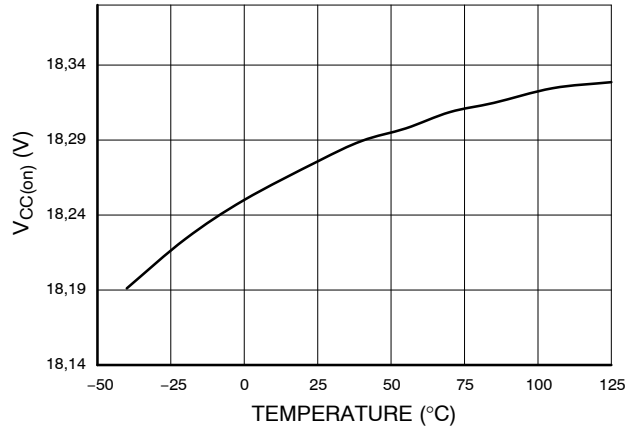

Figure 6.  $V_{CC(on)}$  vs. Temperature

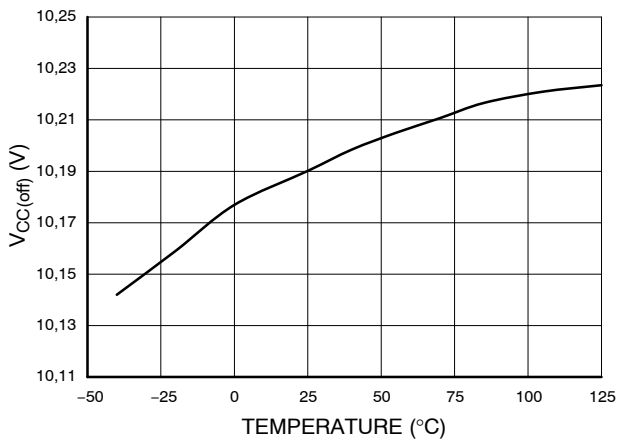

Figure 7.  $V_{CC(off)}$  vs. Temperature

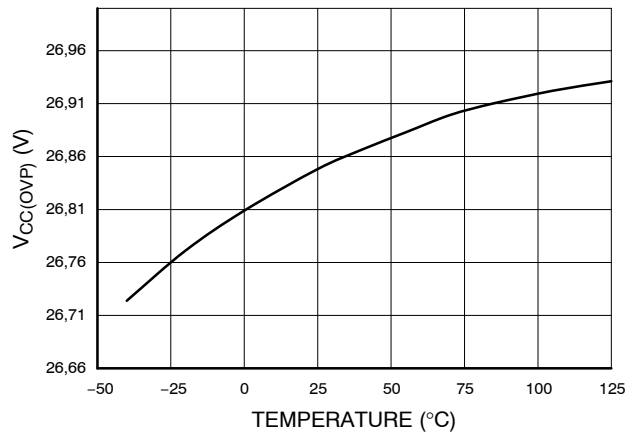

Figure 8.  $V_{CC(OVP)}$  vs. Temperature



TYPICAL CHARACTERISTICS (continued)

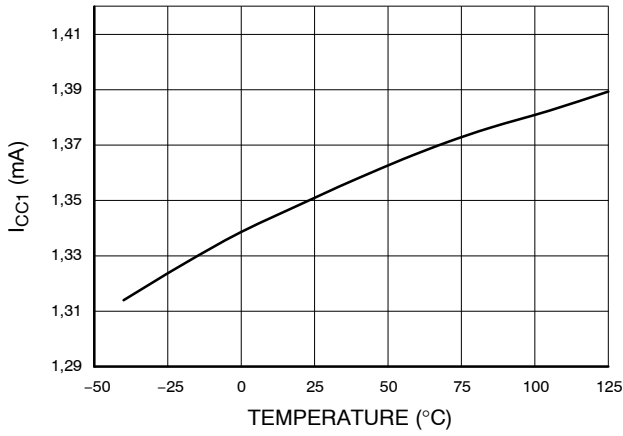

Figure 9. I<sub>CC1</sub> vs. Temperature

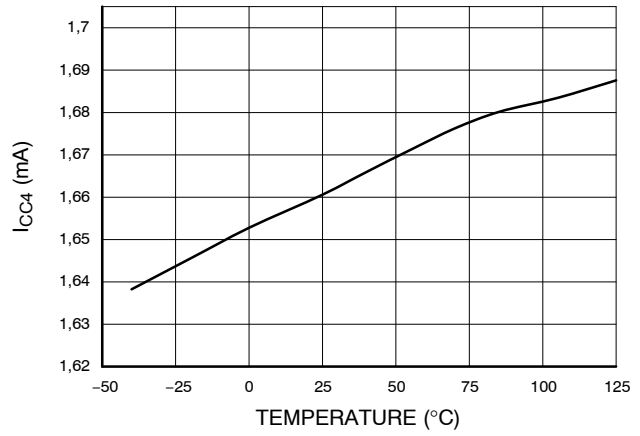

Figure 10. I<sub>CC4</sub> vs. Temperature

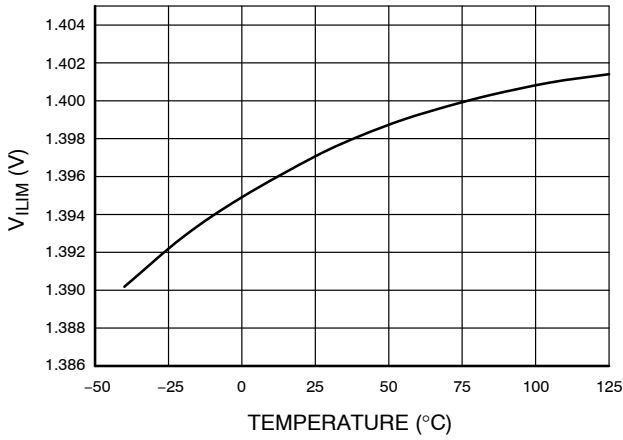

Figure 11. V<sub>ILIM</sub> vs. Temperature

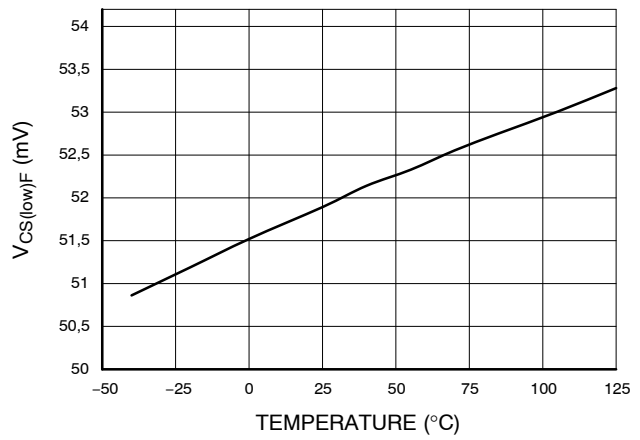

Figure 12. V<sub>CS(low)F</sub> vs. Temperature

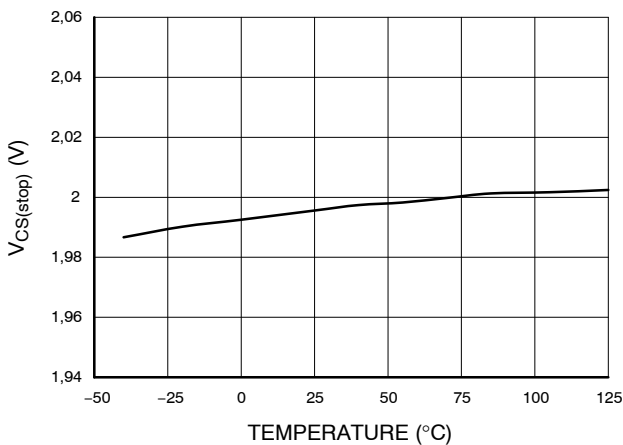

Figure 13. V<sub>CS(stop)</sub> vs. Temperature

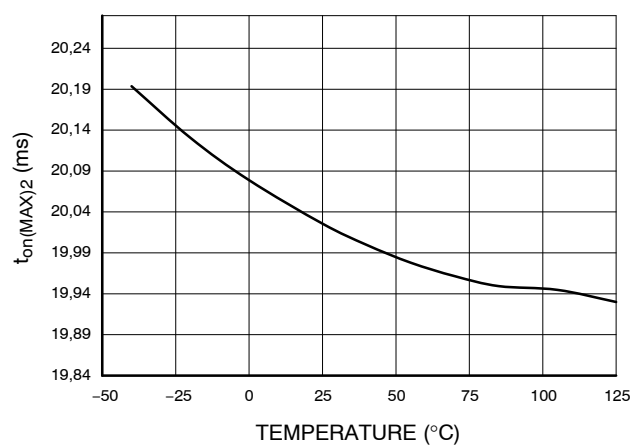

Figure 14. t<sub>on(MAX)2</sub> vs. Temperature

TYPICAL CHARACTERISTICS (continued)

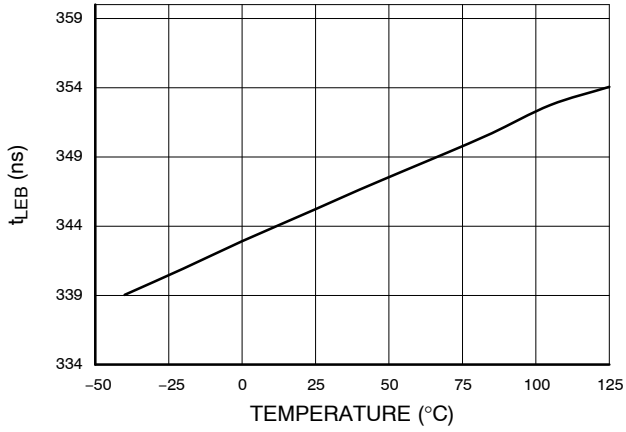

Figure 15.  $t_{LEB}$  vs. Temperature

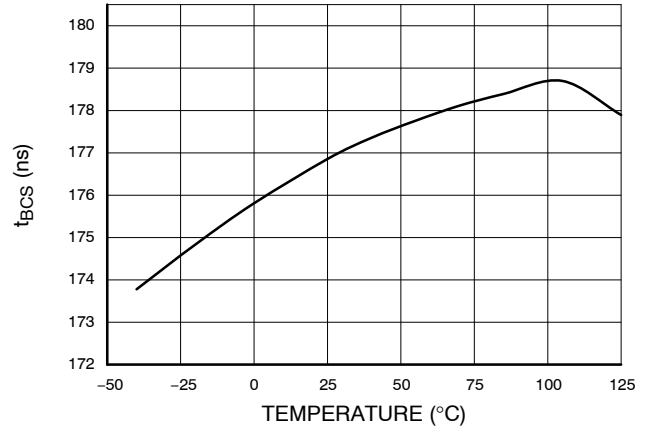

Figure 16.  $t_{BCS}$  vs. Temperature

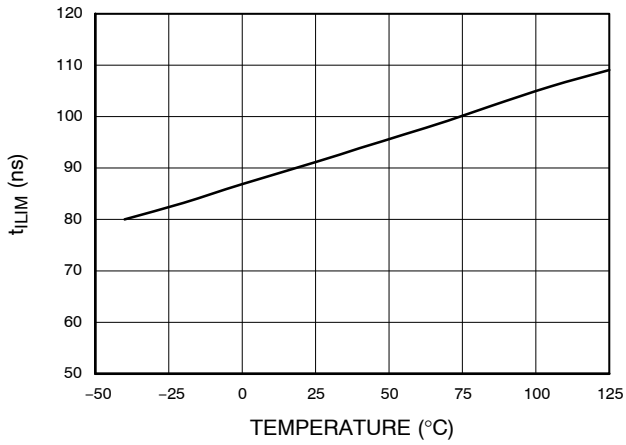

Figure 17.  $t_{ILIM}$  vs. Temperature

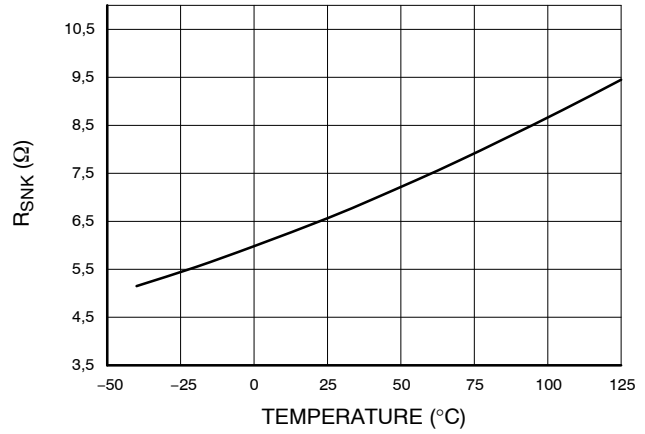

Figure 18.  $R_{SNK}$  vs. Temperature

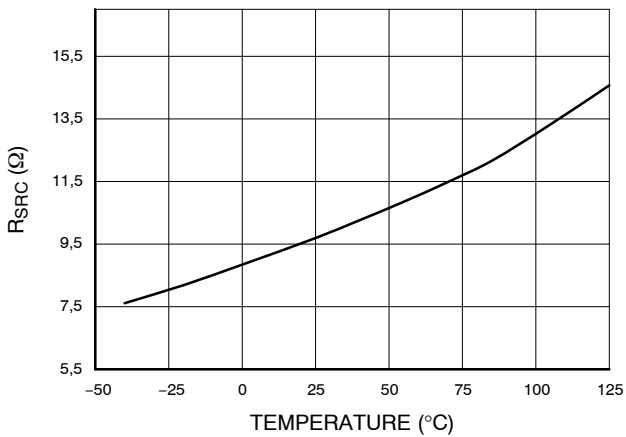

Figure 19.  $R_{SRC}$  vs. Temperature

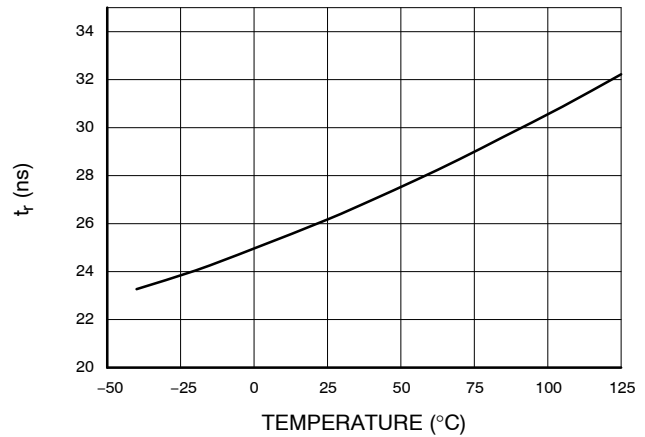

Figure 20.  $t_r$  vs. Temperature

TYPICAL CHARACTERISTICS (continued)

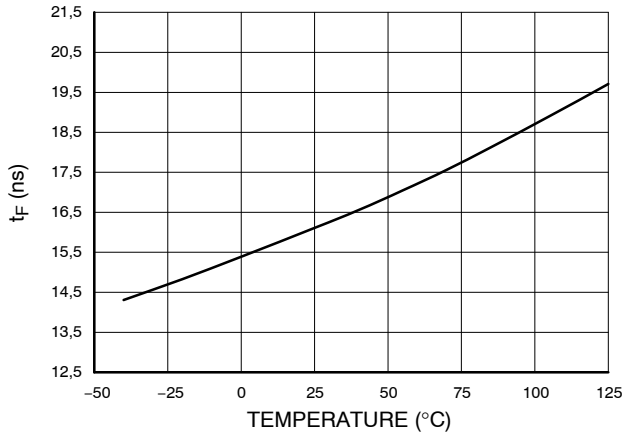

Figure 21.  $t_f$  vs. Temperature

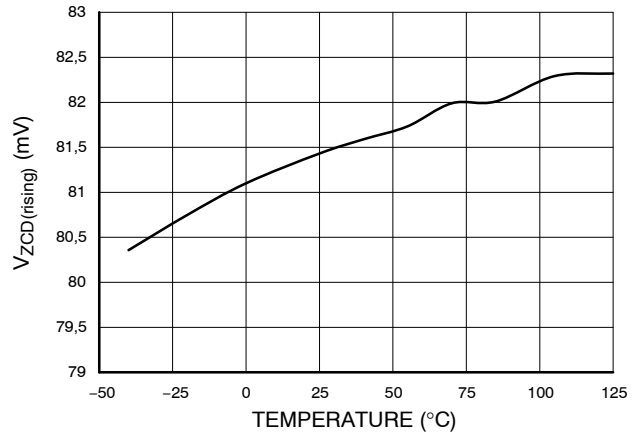

Figure 22.  $V_{ZCD(rising)}$  vs. Temperature

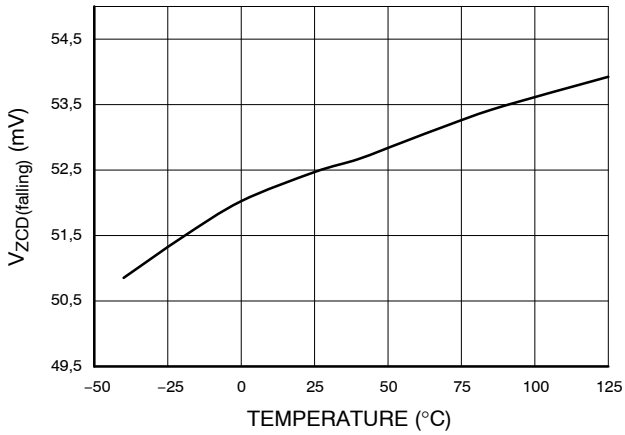

Figure 23.  $V_{ZCD(falling)}$  vs. Temperature

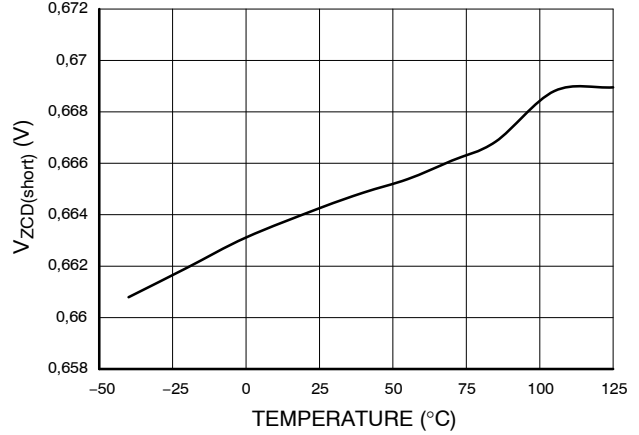

Figure 24.  $V_{ZCD(short)}$  vs. Temperature

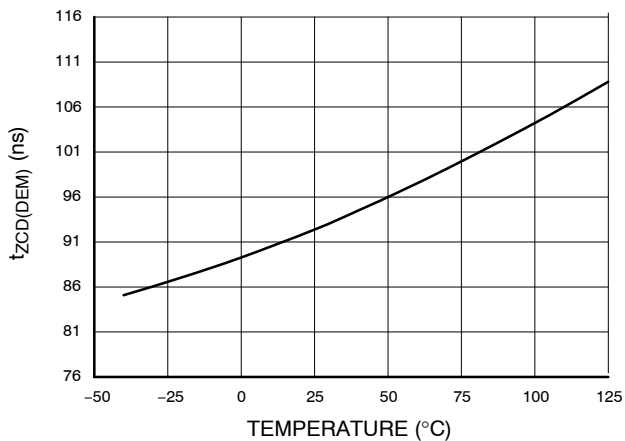

Figure 25.  $t_{ZCD(dem)}$  vs. Temperature

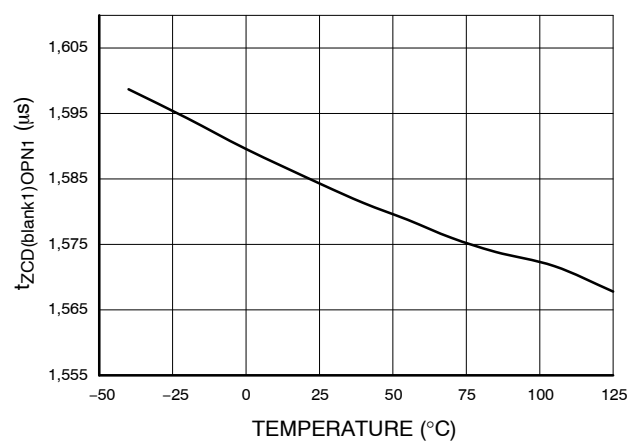

Figure 26.  $t_{ZCD(blank1)OPN1}$  vs. Temperature

TYPICAL CHARACTERISTICS (continued)

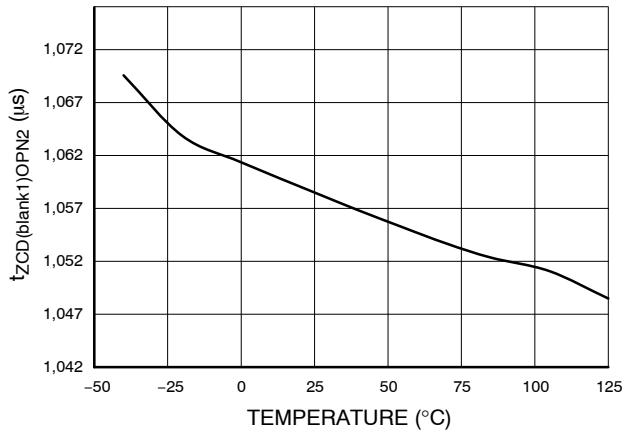

Figure 27.  $t_{ZCD(blank1)OPN2}$  vs. Temperature

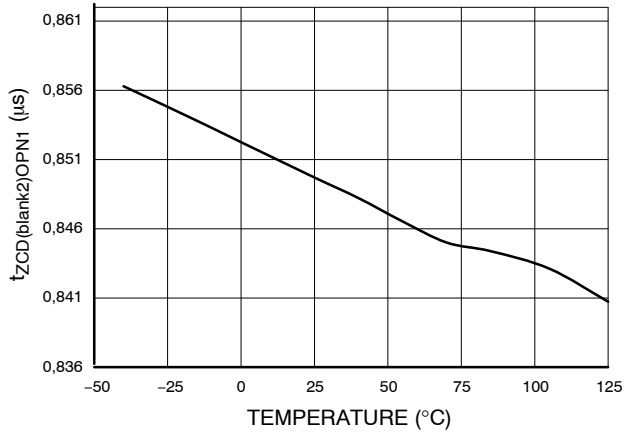

Figure 28.  $t_{ZCD(blank2)OPN1}$  vs. Temperature

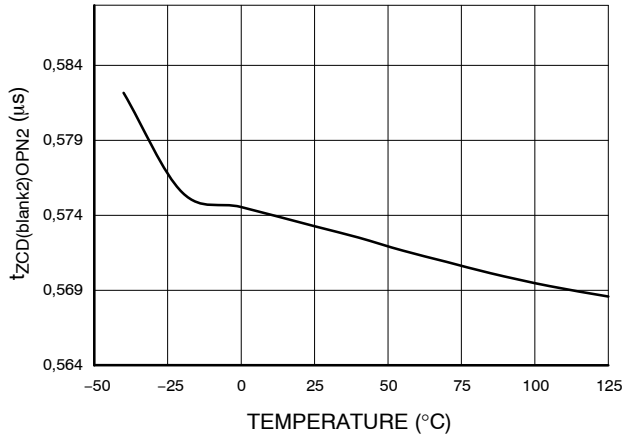

Figure 29.  $t_{ZCD(blank2)OPN2}$  vs. Temperature

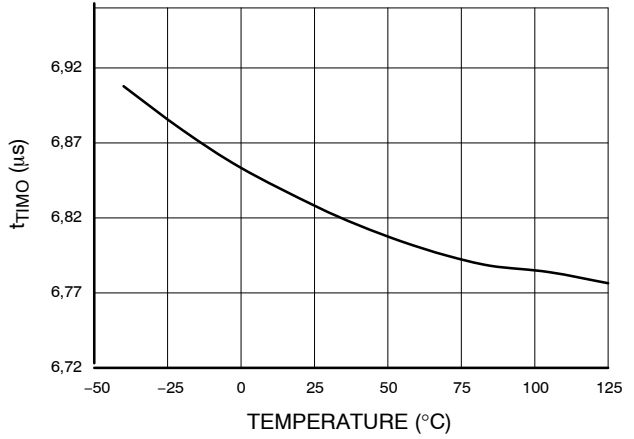

Figure 30.  $t_{TIMO}$  vs. Temperature

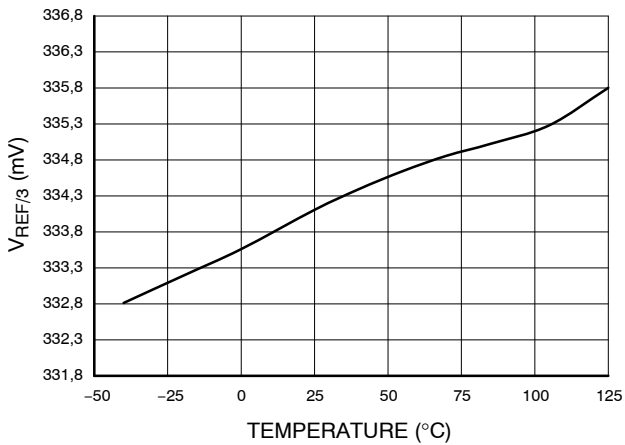

Figure 31.  $V_{REF/3}$  vs. Temperature

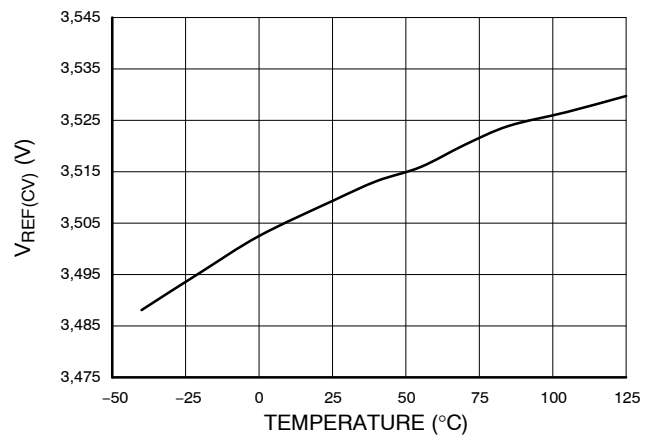

Figure 32.  $V_{REF(CV)}$  vs. Temperature

TYPICAL CHARACTERISTICS (continued)

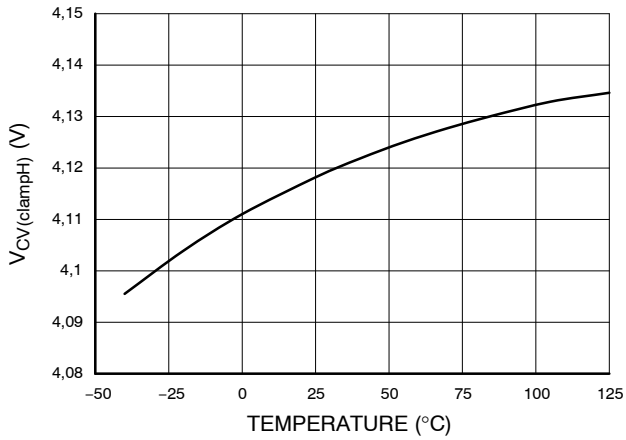

Figure 33.  $V_{CV(clampH)}$  vs. Temperature

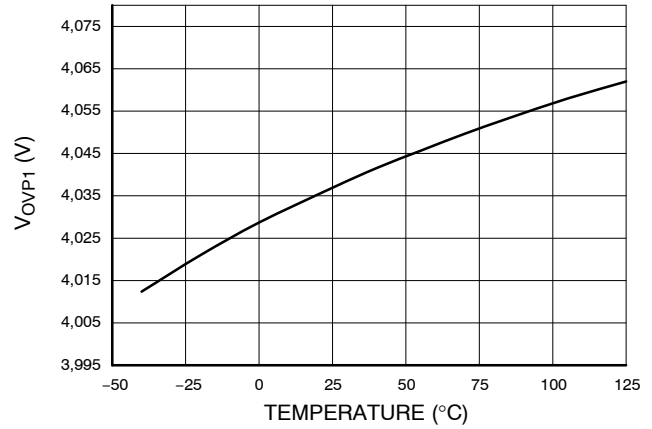

Figure 34.  $V_{OVP1}$  vs. Temperature

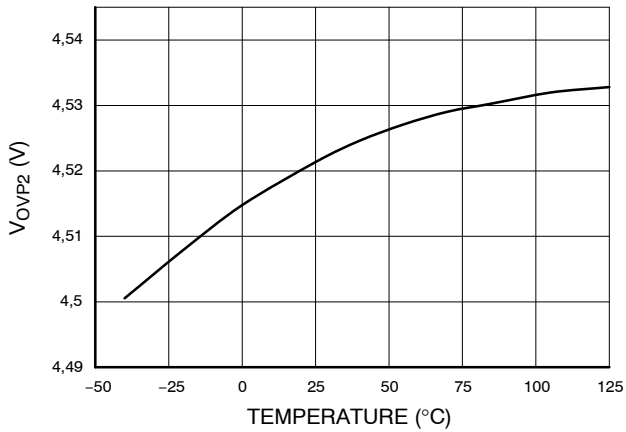

Figure 35.  $V_{OVP2}$  vs. Temperature

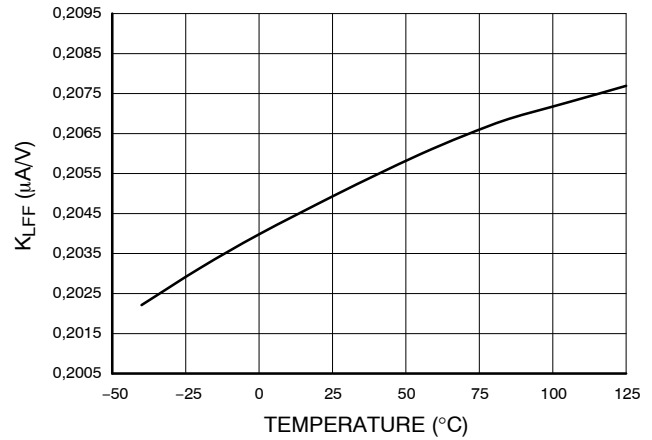

Figure 36.  $K_{LFF}$  vs. Temperature

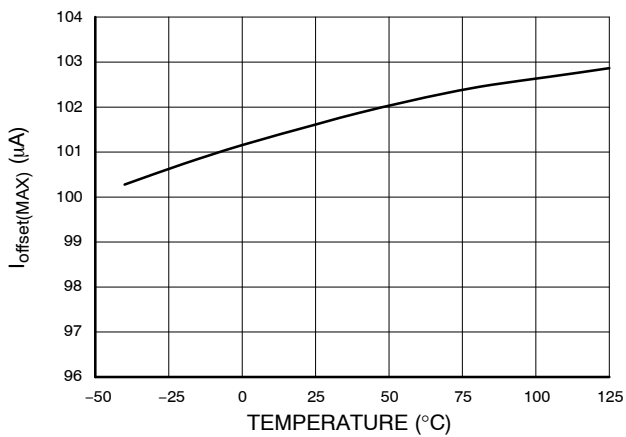

Figure 37.  $I_{offset(MAX)}$  vs. Temperature

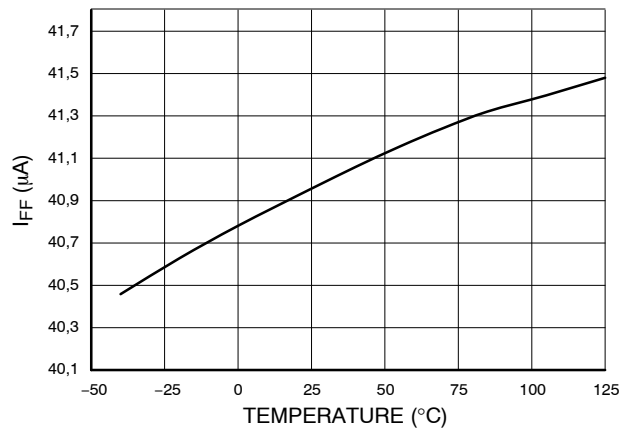

Figure 38.  $I_{FF}$  vs. Temperature

TYPICAL CHARACTERISTICS (continued)

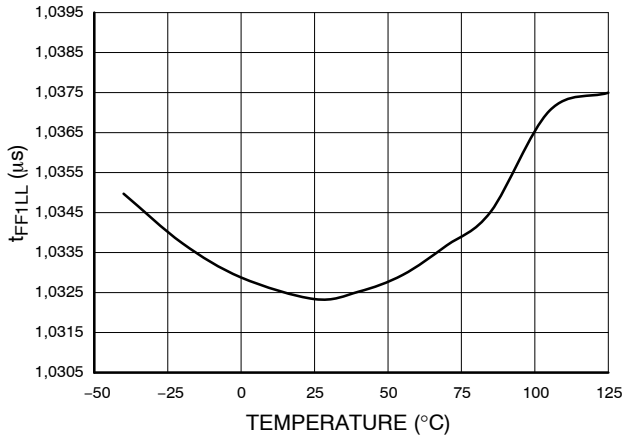

Figure 39.  $t_{FF1LL}$  vs. Temperature

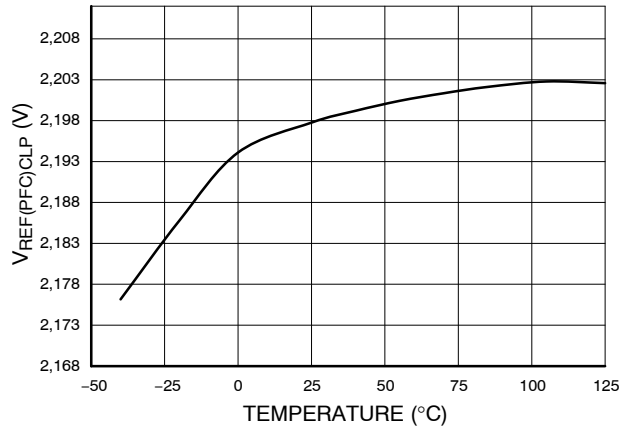

Figure 40.  $V_{REF(PFC)CLP}$  vs. Temperature

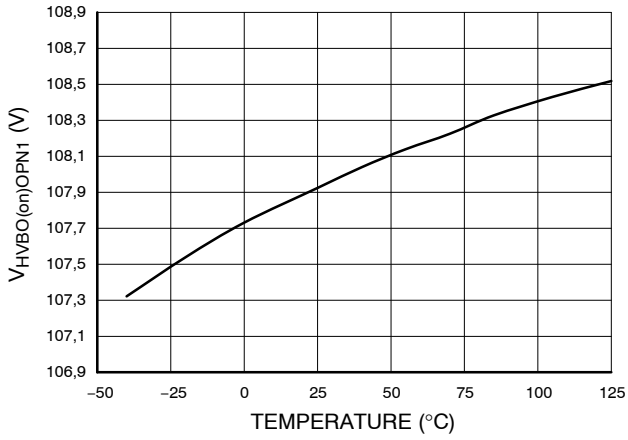

Figure 41.  $V_{HVBO(on)OPN1}$  vs. Temperature

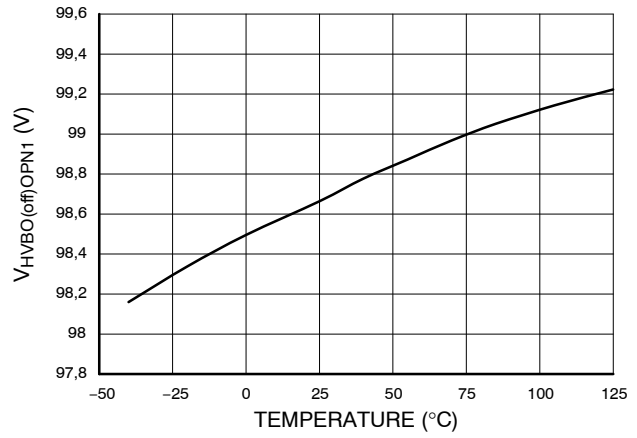

Figure 42.  $V_{HVBO(off)}$  vs. Temperature

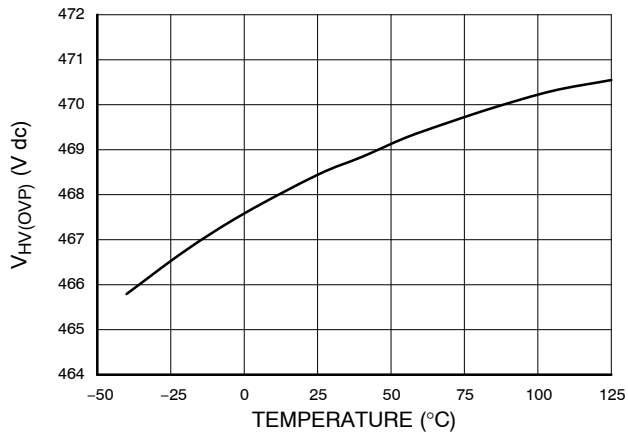

Figure 43.  $V_{HV(OVP)}$  vs. Temperature

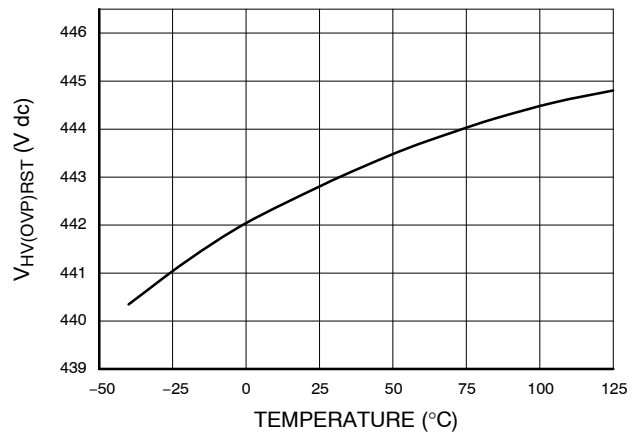

Figure 44.  $V_{HV(OVP)RST}$  vs. Temperature

### Application Information

The NCL30488 implements a current-mode architecture operating in quasi-resonant mode. Thanks to proprietary circuitry, the controller is able to accurately regulate the secondary side current and voltage of the fly-back converter without using any opto-coupler or measuring directly the secondary side current or voltage. The controller provides near unity power factor correction

- **Quasi-Resonance Current-Mode Operation:** implementing quasi-resonance operation in peak current-mode control, the NCL30488 optimizes the efficiency by switching in the valley of the MOSFET drain-source voltage. Thanks to an internal algorithm control, the controller locks-out in a selected valley and remains locked until the input voltage or the output current set point significantly changes.
- **Primary Side Constant Current Control:** thanks to a proprietary circuit, the controller is able to take into account the effect of the leakage inductance of the transformer and allows an accurate control of the secondary side current regardless of the input voltage and output load variation.
- **Primary Side Constant Voltage Regulation:** By monitoring the auxiliary winding voltage, it is possible to regulate accurately the output voltage. The output voltage regulation is typically within  $\pm 2\%$ .
- **Load Transient Compensation:** Since PFC has low loop bandwidth, abrupt changes in the load may cause excessive over or under-shoot. The slow Over Voltage Protection contains the output voltage when it tends to become excessive. In addition, the NCL30488 speeds up the constant voltage regulation loop when the output voltage goes below 85% of its regulation level.
- **Power Factor Correction:** A proprietary concept allows achieving high power factor correction and low THD while keeping accurate constant current and constant voltage control.
- **Line Feed-forward:** allows compensating the variation of the output current caused by the propagation delay.
- **V<sub>CC</sub> Over Voltage Protection:** if the V<sub>CC</sub> pin voltage exceeds an internal limit, the controller shuts down and waits 4 seconds before restarting pulsing.
- **Fast Over Voltage Protection:** If the voltage of ZCD pin exceeds 130% of its regulation level, the controller shuts down and waits 4 s before trying to restart.
- **Brown-Out:** the controller includes a brown-out circuit which safely stops the controller in case the input voltage is too low. The device will automatically restart if the line recovers.
- **Cycle-by-cycle peak current limit:** when the current sense voltage exceeds the internal threshold V<sub>ILIM</sub>, the MOSFET is turned off for the rest of the switching cycle.
- **Winding Short-Circuit Protection:** an additional comparator senses the CS signal and stops the controller

if V<sub>CS</sub> reaches 1.5 x V<sub>ILIM</sub> (after a reduced LEB of t<sub>BCS</sub>). This additional comparator is enabled only during the main LEB duration t<sub>LEB</sub>, for noise immunity reason.

- **Output Under Voltage Protection:** If a too low voltage is applied on ZCD pin for 90 ms time interval, the controllers assume that the output or the ZCD pin is shorted to ground and shutdown. After waiting 4 seconds, the IC restarts switching.
- **Thermal Shutdown:** an internal circuitry disables the gate drive when the junction temperature exceeds 150°C (typically). The circuit resumes operation once the temperature drops below approximately 140°C.

### POWER FACTOR AND CONSTANT CURRENT CONTROL

The NCL30488 embeds an analog/digital block to control the power factor and regulate the output current by monitoring the ZCD, CS and HV pin voltages (signals V<sub>ZCD</sub>, V<sub>HV\_DIV</sub>, V<sub>CS</sub>). This circuit generates the current setpoint signal and compares it to the current sense signal to turn the MOSFET off. The HV pin provides the sinusoidal reference necessary for shaping the input current. The obtained current reference is further modulated so that when averaged over a half line period, it is equal to the output current reference (V<sub>REFX</sub>). The modulation and averaging process is made internally by a digital circuit. If the HV pin properly conveys the sinusoidal shape, power factor will be close to 1. Also, the Total Harmonic Distortion (THD) will be low especially if the output voltage ripple is small.

$$I_{OUT} = \frac{V_{REF}}{2N_{sp}R_{sense}} \quad (\text{eq. 1})$$

Where:

- N<sub>sp</sub> is the secondary to primary transformer turns ratio:  
N<sub>sp</sub> = N<sub>S</sub> / N<sub>P</sub>
- R<sub>sense</sub> is the current sense resistor
- V<sub>REFX</sub> is the output current reference: V<sub>REFX</sub> = V<sub>REF</sub> if no dimming  
The output current reference (V<sub>REFX</sub>) is V<sub>REF</sub> unless the controller operates in constant voltage mode.

### PRIMARY SIDE CONSTANT VOLTAGE CONTROL

The auxiliary winding voltage is sampled internally through the ZCD pin.

A precise internal voltage reference V<sub>REF(CV)</sub> sets the voltage target for the CV loop.

The sampled voltage is applied to the negative input of the constant voltage (CV) operational transconductance amplifier (OTA) and compared to V<sub>REFCV</sub>.

A type 2 compensator is needed at the CV OTA output to stabilize the loop. The COMP pin voltage modify the output current internal reference in order to regulate the output voltage.

When V<sub>COMP</sub> ≥ 4 V, V<sub>REFX</sub> = V<sub>REF</sub>.

When V<sub>COMP</sub> < 0.9 V, V<sub>REFX</sub> = 0 V.

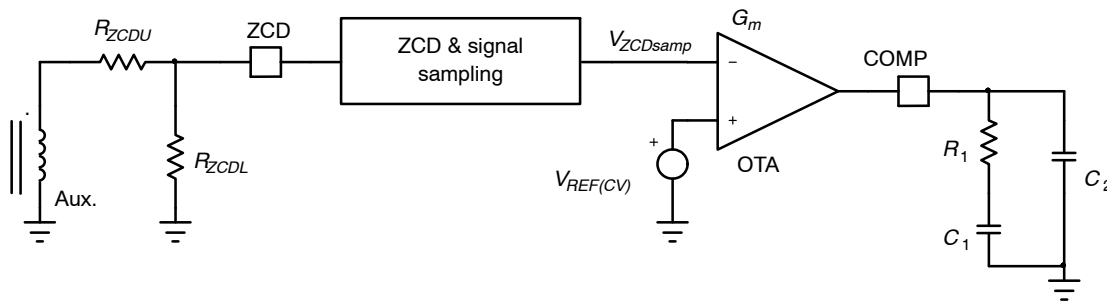

Figure 45. Constant Voltage Feedback Circuit

**Secondary Side Regulation Compatible**

The NCL30488 is able to support secondary-side regulation as well. The controller features an option to provide a pullup resistor  $R_{pullup}$  on COMP pin instead of the CV OTA output. This allows connecting directly an optocoupler collector and properly biases it. The internal voltage biasing  $R_{pullup}$  is around 5 V.

In secondary side regulation, the slow and fast OVP on ZCD pin are still active thus providing an additional over voltage protection. In this case, the ZCD pin resistors should be calculated to trigger  $V_{OVP2}$  at the output voltage of interest.

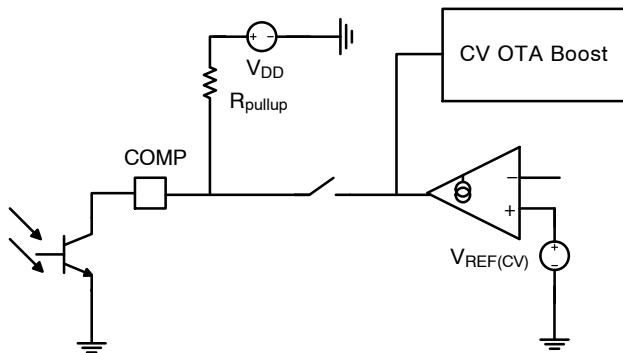

Figure 46. COMP Pin Configuration for Secondary Side Regulation

**STARTUP PHASE (HV STARTUP)**

It is generally requested that the LED driver starts to emit light in less than 1 s and possibly within 300 ms. It is challenging since the start-up consists of the time to charge the  $V_{CC}$  capacitor and that necessary to charge the output capacitor until sufficient current flows into the LED string. This second phase can be particularly long in dimming cases where the secondary current is a portion of the nominal one.

The NCL30488 features a high voltage startup circuit that allows charging  $V_{CC}$  pin capacitor very fast.

When the power supply is first connected to the mains outlet, the internal current source is biased and charges up the  $V_{CC}$  capacitor. When the voltage on this  $V_{CC}$  capacitor reaches the  $V_{CC(on)}$  level, the current source turns off. At this time, the controller is only supplied by the  $V_{CC}$  capacitor, and the auxiliary supply should take over before  $V_{CC}$  collapses below  $V_{CC(off)}$ .

The HV startup circuitry is made of two startup current levels,  $I_{HV(start1)}$  and  $I_{HV(start2)}$ . This helps to protect the controller against short-circuit between  $V_{CC}$  and GND. At power-up, as long as  $V_{CC}$  is below  $V_{CC(TH)}$ , the source delivers  $I_{HV(start1)}$  (around 300  $\mu$ A typical). Then, when  $V_{CC}$  reaches  $V_{CC(TH)}$ , the source smoothly transitions to  $I_{HV(start2)}$  and delivers its nominal value. As a result, in case of short-circuit between  $V_{CC}$  and GND occurring at high line ( $V_{in} = 305$  V rms), the maximum power dissipation will be  $431 \times 300 \mu = 130$  mW instead of 1.5 W if there was only one startup current level.

To speed-up the output voltage rise, the following is implemented:

- The digital OTA output is increased until  $V_{REF(PFC)}$  signal reaches  $V_{REFX}$ . Again, this is to speed-up the control signal rise to their steady state value.
- At the beginning of each operating phase of a  $V_{CC}$  cycle, the digital OTA output is set to 0. Actually, the digital OTA output is set to 0 in the case of a cold start-up or in the case of a start-up sequence following an operation interruption due to a fault. On the other hand, if the  $V_{CC}$  hiccups just because the system fails to start-up in one  $V_{CC}$  cycle, the digital OTA output is not reset to ease the second (or more) attempt.
- If the load is shorted, the circuit will operate in hiccup mode with  $V_{CC}$  oscillating between  $V_{CC(off)}$  and  $V_{CC(on)}$  until the output under voltage protection (UVP) trips. UVP is triggered if the ZCD pin voltage does not exceed  $V_{ZCD(short)}$  within a 90 ms operation of time. This indicates that the ZCD pin is shorted to ground or that an excessive load prevents the output voltage from rising.

**HV Startup Power Dissipation**

At high line (305 V rms and above) the power dissipated by the HV startup in case of fault becomes high. Indeed, in case of fault, the NCL30488 is directly supplied by the HV rail. The current flowing through the HV startup will heat the controller. It is highly recommended adding enough copper around the controller to decrease the  $R_{\theta JA}$  of the controller.

Adding a minimum pad area of 215 mm<sup>2</sup> of 35  $\mu$ m copper (1 oz) drops the  $R_{\theta JA}$  to around 120°C/W (no air flow,  $R_{\theta JA}$  measured at ADIM pin)

The PCB layout shown in Figure 47 is a layout example to achieve low  $R_{\theta JA}$ .



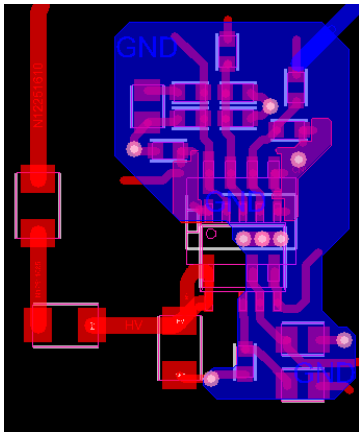

Figure 47. PCD Layout Example

The application note ANDXXXX gives more details about strategies to decrease the power dissipation of the HV startup circuit.

**Cycle-by-Cycle Current Limit**

When the current sense voltage exceeds the internal threshold  $V_{ILIM}$ , the MOSFET is turned off for the rest of the switching cycle.

**Winding and Output Diode Short-Circuit Protection**

In parallel to the cycle-by-cycle sensing of the CS pin, another comparator with a reduced LEB ( $t_{BCS}$ ) and a threshold of  $(V_{CS(stop)} = 140\% \times V_{ILIM})$  monitors the CS pin to detect a winding or an output diode short circuit. The controller shuts down if it detects 4 consecutive pulses during which the CS pin voltage exceeds  $V_{CS(stop)}$ .

The controller goes into auto-recovery mode.

**Valley Lockout**

Quasi-Square wave resonant systems have a wide switching frequency excursion. The switching frequency increases when the output load decreases or when the input voltage increases. The switching frequency of such systems must be limited.

The NCL30488 changes valley as  $V_{REFX}$  decreases and as the input voltage increases and as the output current setpoint is varied during dimming. This limits the frequency excursion.

By default, when the output current is not dimmed, the controller operates in the first valley at low line and in the second valley at high line.

(prog. option to have the operating valley incremented by 1 at high line for better  $I_{out}$  control at 305 V rms.)

Table 1. VALLEY SELECTION

| $V_{REFX}$ value at which the Controller Changes Valley ( $I_{out}$ Decreasing) | $V_{HV\_DIV}$ Voltage for Valley Change          |                 |                 |                                    | $V_{REFX}$ Value at Which the Controller Changes Valley ( $I_{out}$ Increasing) |
|---|--|-----------------|-----------------|------------------------------------|---|
|   | 0  | --LL--          | 2.3 V           | --HL--                             |   |
| $I_{out}$ decreases<br>   | 100%   | 1 <sup>st</sup> |                 | 2 <sup>nd</sup> (3 <sup>rd</sup> ) | 100%  |
|   | 80%  |                 | 2 <sup>nd</sup> |                                    | 3 <sup>rd</sup> (4 <sup>th</sup> )  |
|   | 65%  |                 | 3 <sup>rd</sup> |                                    | 4 <sup>th</sup> (5 <sup>th</sup> )  |
|   | 50%  |                 | 4 <sup>th</sup> |                                    | 5 <sup>th</sup> (6 <sup>th</sup> )  |
|   | 35%  |                 | 5 <sup>th</sup> |                                    | 6 <sup>th</sup> (7 <sup>th</sup> )  |
|   | 25%  |                 | FF mode         |                                    | FF mode   |
|   | 0%   |                 |                 |                                    |   |
|   | 0  | --LL--          | 2.3 V           | --HL--                             | 5 V   |
|   |  |                 |                 |                                    |   |
|   | Internal $V_{HV\_DIV}$ Voltage for Valley Change |                 |                 |                                    |   |

**Zero Crossing Detection Block**

The ZCD pin allows detecting when the drain-source voltage of the power MOSFET reaches a valley.

A valley is detected when the ZCD pin voltage crosses below the 55 mV internal threshold.

At startup or in case of extremely damped free oscillations, the ZCD comparator may not be able to detect the valleys. To avoid such a situation, Optimus Prime features a Time-Out circuit that generates pulses if the voltage on ZCD pin stays below the 55 mV threshold for 6.5  $\mu$ s.

The Time-out also acts as a substitute clock for the valley detection and simulates a missing valley in case of too damped free oscillations.

At startup, the output voltage reflected on the auxiliary winding is low. Because of the ZCD resistor bridge setting the constant voltage regulation target, the voltage on the ZCD pin is very low and the ZCD comparator might be unable to detect the valleys. In this condition, setting the DRV Latch with the 6.5  $\mu$ s time-out leads to a continuous conduction mode operation (CCM) at the beginning of the soft-start. This CCM operation only last a few cycles until the voltage on ZCD pin becomes high enough and trips the ZCD comparator.

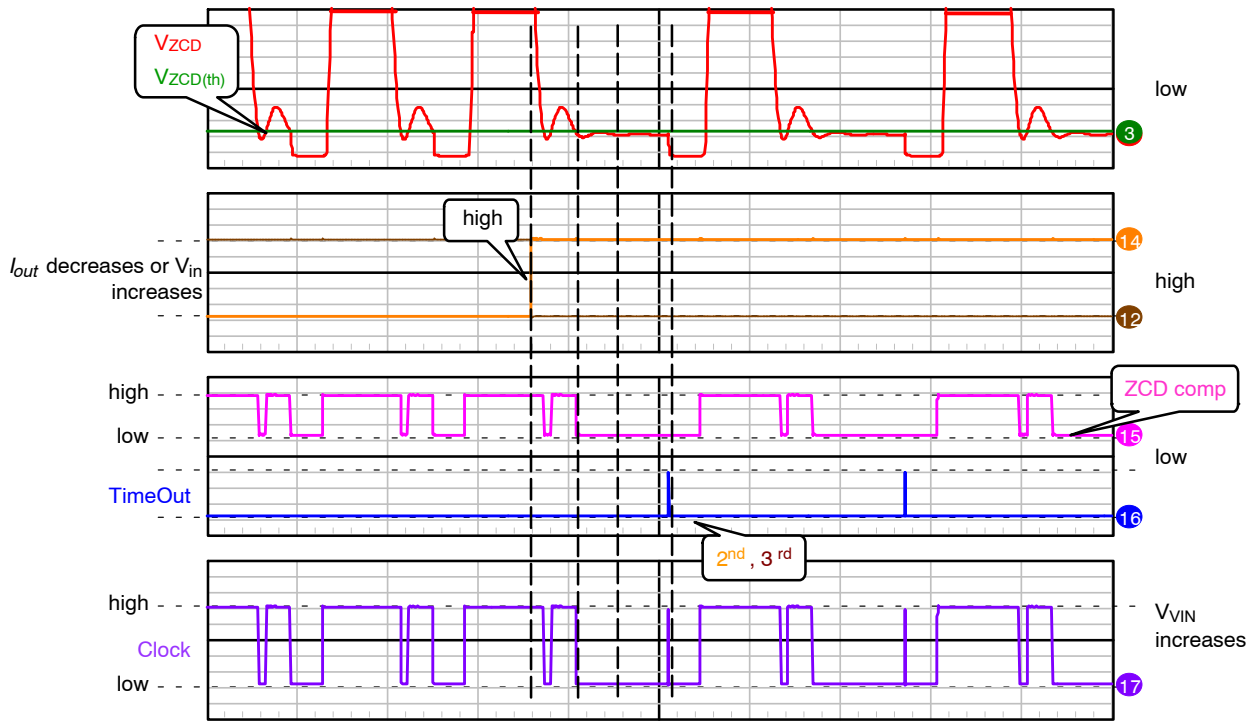

Figure 48. Valley Detection and Time-out Chronograms

If the ZCD pin or the auxiliary winding happen to be shorted the time-out function would normally make the controller keep switching and hence lead to improper regulation of the LED current.

The Under Voltage Protection (UVP) is implemented to avoid these scenarios: a secondary timer starts counting when the ZCD voltage is below the  $V_{ZCD(short)}$  threshold. If this timer reaches 90 ms, the controller detects a fault and enters the auto-recovery fault mode.

**ZCD Over Voltage Protection**

Because of the power factor correction, it is necessary to set the crossover frequency of the CV loop very low (target 10 Hz, depending on power stage phase shift). Because the loop is slow, the output voltage can reach high value during startup or during an output load step. It is necessary to limit the output voltage excursion. For this, the NCL30488 features a slow OVP and a fast OVP on ZCD pin.

*Slow OVP*

If ZCD voltage exceeds  $V_{OVP1}$  for 4 consecutive switching cycles, the controller stops switching during 1.4 ms. The PFC loop is not reset. After 1.4 ms, the controller initiates a new DRV pulse to refresh ZCD sampling voltage. If  $V_{ZCD}$  is still too high ( $V_{ZCD} > 115\% V_{REF(CV)}$ ), the controller continues to switch with a 1.4 ms period. The controller resumes its normal operation when  $V_{ZCD} < 115\% V_{REF(CV)}$ .

During slow OVP, the peak current setpoint is COMP pin voltage scaled down by a fixed ratio.

*Fast OVP*

If ZCD voltage exceeds  $V_{OVP2}$  (130% of  $V_{REF(CV)}$ ) for 4 consecutive switching cycles (slow OVP not triggered) or for 2 switching cycles if the slow OVP has already been triggered, the controller detects a fault and starts the auto-recovery fault mode (cf: Fault Management Section)

**Line Feedforward**

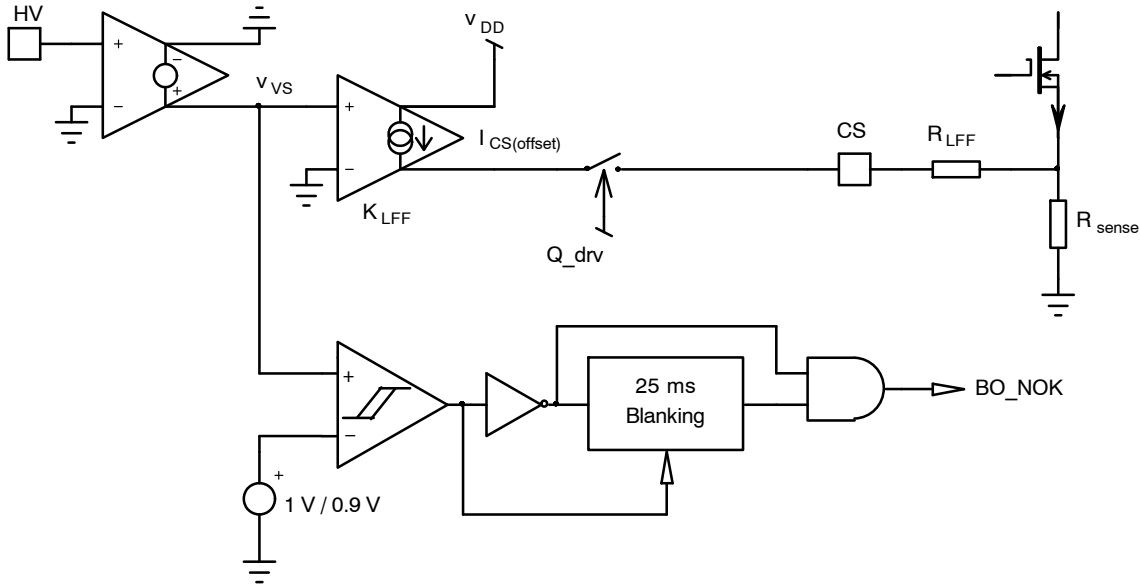

**Figure 49. Line Feed-Forward and Brown-out Schematic**

The line voltage is sensed by the HV pin and converted into a current. By adding an external resistor in series between the sense resistor and the CS pin, a voltage offset proportional to the line voltage is added to the CS signal. The offset is applied only during the MOSFET on-time in order to not influence the detection of the leakage inductance reset.

The offset is always applied even at light load in order to improve the current regulation at low output load.

**Brown-out**

In order to protect the supply against a very low input voltage, the controller features a brown-out circuit with a fixed ON/OFF threshold. The controller is allowed to start if a voltage higher than  $V_{HVBO(on)}$  is applied to the HV pin and shuts-down if the HV pin voltage decreases and stays

below  $V_{HVBO(off)}$  for 25 ms typical. Exiting a brown-out condition overrides the hiccup on  $V_{CC}$  ( $V_{CC}$  does not wait to reach  $V_{CC(off)}$ ) and the IC immediately goes into startup mode.

An option with higher brown-out levels is also available (see ordering table and electricals parameters)

**Line OVP**

In order to protect the power supply in case of too high input voltage, the NCL30488 features a line over voltage protection. When the voltage on HV pin exceeds  $V_{HV(OVP)}$  the controller stops switching;  $V_{CC}$  hiccups.

When  $V_{HV}$  becomes lower than  $V_{HV(OVP)RST}$  for more than 25 ms, the controller initiates a clean startup sequence and re-starts switching.

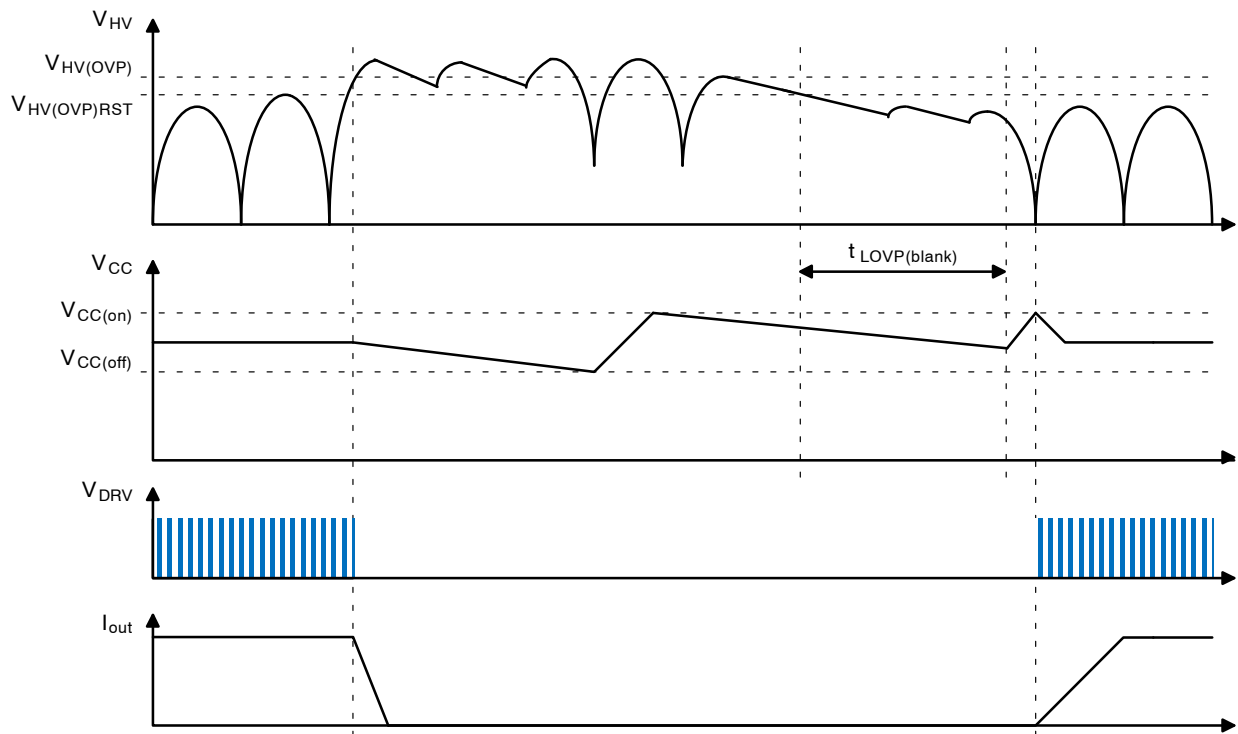

Figure 50. Line OVP Chronograms

**Protections**

The circuit incorporates a large variety of protections to make the LED driver very rugged.

Among them, we can list:

- **Fault of the GND connection**  
If the GND pin is properly connected, the supply current drawn from the positive terminal of the  $V_{CC}$  capacitor, flows out of the GND pin to return to the negative terminal of the  $V_{CC}$  capacitor. If the GND pin is not connected, the circuit ESD diodes offer another return path. The accidental non connection of the GND pin can hence be detected by detecting that one of this ESD diode is conducting. Practically, the ESD diode of CS pin is monitored. If such a fault is detected for 200  $\mu$ s, the circuit stops generating DRV pin.
- **Output short circuit situation (Output Under Voltage Protection)**  
Overload is detected by monitoring the ZCD pin voltage: if it remains below  $V_{ZCD(short)}$  for 90 ms, an output short circuit is detected and the circuit stops generating pulses for 4 s. When this 4 s delay has elapsed, the circuit attempts to restart.
- **ZCD pin incorrect connection:**
  - ◆ If the ZCD pin grounded, the circuit will detect an output short circuit situation when 90 ms delay has elapsed.
  - ◆ A 200 k $\Omega$  resistor pulls down the ZCD pin so that the output short circuit detection trips if the ZCD pin is not connected (floating).

- **Winding or Output Diode Short Circuit protection**  
The circuit detects this failure when 4 consecutive DRV pulses occur within which the CS pin voltage exceeds ( $V_{CS(stop)} = 140\% \times V_{ILIM}$ ). In this case, the controller enters auto-recovery mode (4-s operation interruption between active bursts).
- **$V_{CC}$  Over Voltage Protection**  
The circuit stops generating pulses if the  $V_{CC}$  exceeds  $V_{CC(OVP)}$  and enters auto-recovery mode. This feature protects the circuit if output LEDs happen to be disconnected.
- **ZCD fast OVP**  
If ZCD voltage exceeds  $V_{ZCD(OVP2)}$  for 4 consecutive switching cycles (slow OVP not triggered) or for 2 switching cycles if the slow OVP has already been triggered, the controller detects a fault and enters auto-recovery mode (4 s operation interruption between active bursts).
- **Die Over Temperature (TSD)**  
The circuit stops operating if the junction temperature ( $T_J$ ) exceeds 150°C typically. The controller remains off until  $T_J$  goes below nearly 130°C.
- **Brown-Out Protection (BO)**  
The circuit prevents operation when the line voltage is too low to avoid an excessive stress of the LED driver. Operation resumes as soon as the line voltage is high enough and  $V_{CC}$  is higher than  $V_{CC(on)}$ .

## NCL30488

- CS pin short to ground

The CS pin is checked at start-up (cold start-up or after a brown-out event). A current source ( $I_{CS(short)}$ ) is applied to the pin and no DRV pulse is generated until the CS pin exceeds  $V_{CS(low)}$ .  $I_{CS(short)}$  and  $V_{CS(low)}$  are 500  $\mu$ A and 60 mV typically ( $V_{CS}$  rising). The typical minimum impedance to be placed on the CS pin for operation is then 120  $\Omega$ . In practice, it is recommended to place more than

250  $\Omega$  to take into account possible parametric deviations. Also, along the circuit operation, the CS pin could happen to be grounded. If it is grounded, the MOSFET conduction time is limited by the 20  $\mu$ s maximum on-time. If such an event occurs, a new pin impedance test is made.

- Line overvoltage protection (see [Line OVP](#) section)

### ORDERING TABLE OPTION

| OPN #<br>NCL30488__ | Maximum Dead-time |             |        | $V_{REF}$ |        | Max. On-time |            | ZCD Blanking |             | Valley Transition from LL to HL    |                                    | Standby Mode |     | Line Range Detector |     |
|---------------------|-------------------|-------------|--------|-----------|--------|--------------|------------|--------------|-------------|------------------------------------|------------------------------------|--------------|-----|---------------------|-----|
|                     | 250 $\mu$ s       | 687 $\mu$ s | 1.4 ms | 200 mV    | 333 mV | 20 $\mu$ s   | 33 $\mu$ s | 1 $\mu$ s    | 1.5 $\mu$ s | 1 <sup>st</sup> to 2 <sup>nd</sup> | 1 <sup>st</sup> to 3 <sup>rd</sup> | On           | Off | On                  | Off |
| NCL30488A2          |                   | x           |        |           | x      | x            |            | x            |             | x                                  |                                    |              | x   | x                   |     |
| NCL30488A3          |                   | x           |        |           | x      | x            |            | x            |             | x                                  |                                    |              | x   | x                   |     |
| NCL30488A4          |                   | x           |        |           | x      | x            |            | x            |             | x                                  |                                    |              | x   | x                   |     |

| OPN #<br>NCL30488__ | Line OVP |     | Frozen Peak Current During Standby Mode $V_{CS(SBY)}$ |        |        | Brown-out Levels       |                         | COMP Pin $R_{pullup}$ (CV OTA output disconnected) |     |
|---------------------|----------|-----|---|--------|--------|------------------------|-------------------------|--|-----|
|                     | On       | Off | 380 mV  | 330 mV | 280 mV | On: 108 V<br>Off: 98 V | On: 138 V<br>Off: 129 V | On   | Off |
| NCL30488A2          | x        |     |   |        | NA     |                        | x                       |  | x   |
| NCL30488A3          | x        |     |   |        | NA     | x                      |                         |  | x   |
| NCL30488A4          | x        |     |   |        | NA     | x                      |                         | x  |     |

### ORDERING INFORMATION

| Device     | Marking  | Package type                       | Shipping†          |
|------------|----------|------------------------------------|--------------------|
| NCL30488A2 | L30486A2 | SOIC7 – P7 COMP VHV PBFH (Pb-Free) | 2500 / Tape & Reel |
| NCL30488A3 | L30488A3 | SOIC7 – P7 COMP VHV PBFH (Pb-Free) | 2500 / Tape & Reel |
| NCL30488A4 | L30488A4 | SOIC7 – P7 COMP VHV PBFH (Pb-Free) | 2500 / Tape & Reel |

†For information on tape and reel specifications, including part orientation and tape sizes, please refer to our Tape and Reel Packaging Specifications Brochure, BRD8011/D.

# MECHANICAL CASE OUTLINE PACKAGE DIMENSIONS

ON Semiconductor®



SCALE 1:1

SOIC-7  
CASE 751U-01  
ISSUE E

DATE 20 OCT 2009

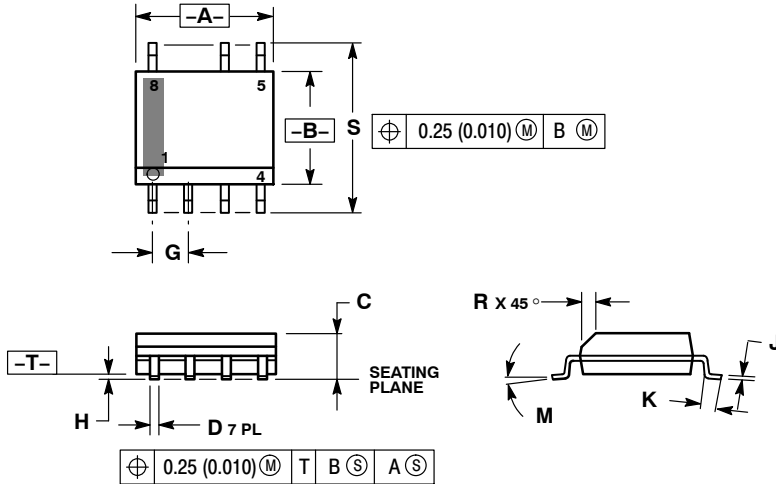

NOTES:

1. DIMENSIONING AND TOLERANCING PER ANSI Y14.5M, 1982.
2. CONTROLLING DIMENSION: MILLIMETER.
3. DIMENSION A AND B ARE DATUMS AND T IS A DATUM SURFACE.
4. DIMENSION A AND B DO NOT INCLUDE MOLD PROTRUSION.
5. MAXIMUM MOLD PROTRUSION 0.15 (0.006) PER SIDE.

| DIM | MILLIMETERS |      | INCHES    |       |
|-----|-------------|------|-----------|-------|
|     | MIN         | MAX  | MIN       | MAX   |
| A   | 4.80        | 5.00 | 0.189     | 0.197 |
| B   | 3.80        | 4.00 | 0.150     | 0.157 |
| C   | 1.35        | 1.75 | 0.053     | 0.069 |
| D   | 0.33        | 0.51 | 0.013     | 0.020 |
| G   | 1.27 BSC    |      | 0.050 BSC |       |
| H   | 0.10        | 0.25 | 0.004     | 0.010 |
| J   | 0.19        | 0.25 | 0.007     | 0.010 |
| K   | 0.40        | 1.27 | 0.016     | 0.050 |
| M   | 0°          | 8°   | 0°        | 8°    |
| N   | 0.25        | 0.50 | 0.010     | 0.020 |
| S   | 5.80        | 6.20 | 0.228     | 0.244 |

SOLDERING FOOTPRINT\*

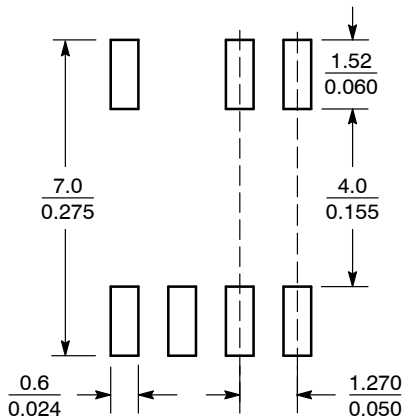

SCALE 6:1 (mm/inches)

\*For additional information on our Pb-Free strategy and soldering details, please download the ON Semiconductor Soldering and Mounting Techniques Reference Manual, SOLDERRM/D.

GENERIC MARKING DIAGRAM

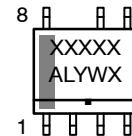

- XXX = Specific Device Code
- A = Assembly Location
- L = Wafer Lot
- Y = Year
- W = Work Week
- = Pb-Free Package

\*This information is generic. Please refer to device data sheet for actual part marking. Pb-Free indicator, "G" or microdot "▪", may or may not be present.

STYLES ON PAGE 2

|                  |             |  |
|------------------|-------------|--|
| DOCUMENT NUMBER: | 98AON12199D | Electronic versions are uncontrolled except when accessed directly from the Document Repository. Printed versions are uncontrolled except when stamped "CONTROLLED COPY" in red. |
| DESCRIPTION:     | 7-LEAD SOIC | PAGE 1 OF 2  |

ON Semiconductor and ON are trademarks of Semiconductor Components Industries, LLC dba ON Semiconductor or its subsidiaries in the United States and/or other countries. ON Semiconductor reserves the right to make changes without further notice to any products herein. ON Semiconductor makes no warranty, representation or guarantee regarding the suitability of its products for any particular purpose, nor does ON Semiconductor assume any liability arising out of the application or use of any product or circuit, and specifically disclaims any and all liability, including without limitation special, consequential or incidental damages. ON Semiconductor does not convey any license under its patent rights nor the rights of others.

**SOIC-7**  
**CASE 751U-01**  
**ISSUE E**

DATE 20 OCT 2009

**STYLE 1:**

- PIN 1. EMITTER
- 2. COLLECTOR
- 3. COLLECTOR
- 4. EMITTER
- 5. EMITTER
- 6.
- 7. NOT USED
- 8. EMITTER

**STYLE 2:**

- PIN 1. COLLECTOR, DIE, #1
- 2. COLLECTOR, #1
- 3. COLLECTOR, #2
- 4. COLLECTOR, #2
- 5. BASE, #2
- 6. EMITTER, #2
- 7. NOT USED
- 8. EMITTER, #1

**STYLE 3:**

- PIN 1. DRAIN, DIE #1
- 2. DRAIN, #1
- 3. DRAIN, #2
- 4. DRAIN, #2
- 5. GATE, #2
- 6. SOURCE, #2
- 7. NOT USED
- 8. SOURCE, #1

**STYLE 4:**

- PIN 1. ANODE
- 2. ANODE
- 3. ANODE
- 4. ANODE
- 5. ANODE
- 6. ANODE
- 7. NOT USED
- 8. COMMON CATHODE

**STYLE 5:**

- PIN 1. DRAIN
- 2. DRAIN
- 3. DRAIN
- 4. DRAIN
- 5.
- 6.
- 7. NOT USED
- 8. SOURCE

**STYLE 6:**

- PIN 1. SOURCE
- 2. DRAIN
- 3. DRAIN
- 4. SOURCE
- 5. SOURCE
- 6.
- 7. NOT USED
- 8. SOURCE

**STYLE 7:**

- PIN 1. INPUT
- 2. EXTERNAL BYPASS
- 3. THIRD STAGE SOURCE
- 4. GROUND
- 5. DRAIN
- 6. GATE 3
- 7. NOT USED
- 8. FIRST STAGE Vd

**STYLE 8:**

- PIN 1. COLLECTOR (DIE 1)
- 2. BASE (DIE 1)
- 3. BASE (DIE 2)
- 4. COLLECTOR (DIE 2)
- 5. COLLECTOR (DIE 2)
- 6. EMITTER (DIE 2)
- 7. NOT USED
- 8. COLLECTOR (DIE 1)

**STYLE 9:**

- PIN 1. EMITTER (COMMON)
- 2. COLLECTOR (DIE 1)
- 3. COLLECTOR (DIE 2)
- 4. EMITTER (COMMON)
- 5. EMITTER (COMMON)
- 6. BASE (DIE 2)
- 7. NOT USED
- 8. EMITTER (COMMON)

**STYLE 10:**

- PIN 1. GROUND
- 2. BIAS 1
- 3. OUTPUT
- 4. GROUND
- 5. GROUND
- 6. BIAS 2
- 7. NOT USED
- 8. GROUND

**STYLE 11:**

- PIN 1. SOURCE (DIE 1)
- 2. GATE (DIE 1)
- 3. SOURCE (DIE 2)
- 4. GATE (DIE 2)
- 5. DRAIN (DIE 2)
- 6. DRAIN (DIE 2)
- 7. NOT USED
- 8. DRAIN (DIE 1)

|                         |                    |   |
|-------------------------|--------------------|---|
| <b>DOCUMENT NUMBER:</b> | <b>98AON12199D</b> | Electronic versions are uncontrolled except when accessed directly from the Document Repository.<br>Printed versions are uncontrolled except when stamped "CONTROLLED COPY" in red. |
| <b>DESCRIPTION:</b>     | <b>7-LEAD SOIC</b> | <b>PAGE 2 OF 2</b>  |

ON Semiconductor and are trademarks of Semiconductor Components Industries, LLC dba ON Semiconductor or its subsidiaries in the United States and/or other countries. ON Semiconductor reserves the right to make changes without further notice to any products herein. ON Semiconductor makes no warranty, representation or guarantee regarding the suitability of its products for any particular purpose, nor does ON Semiconductor assume any liability arising out of the application or use of any product or circuit, and specifically disclaims any and all liability, including without limitation special, consequential or incidental damages. ON Semiconductor does not convey any license under its patent rights nor the rights of others.