

Power Factor Corrected LED Driver with Primary Side CC/CV



SOIC-7
 CASE 751U

Product Preview NCL30488B

The NCL30488B is a power factor corrected flyback controller targeting isolated constant current LED drivers. The controller operates in a quasi-resonant mode to provide high efficiency. Thanks to a novel control method, the device is able to tightly regulate a constant LED current from the primary side. This removes the need for secondary side feedback circuitry, its biasing and for an optocoupler.

The device is highly integrated with a minimum number of external components. A robust suite of safety protection is built in to simplify the design.

Features

- High Voltage Startup
- Quasi-resonant Peak Current-mode Control Operation
- Primary Side Feedback
- CC / CV Accurate Control V_{in} up to 320 V rms
- Tight LED Constant Current Regulation of $\pm 2\%$ Typical
- Digital Power Factor Correction
- Cycle by Cycle Peak Current Limit
- Wide Operating V_{CC} Range
- -40 to $+125^{\circ}\text{C}$
- Standby Mode
- Robust Protection Features
 - ◆ Brown-Out
 - ◆ OVP on V_{CC}
 - ◆ Constant Voltage / LED Open Circuit Protection
 - ◆ Winding Short Circuit Protection
 - ◆ Secondary Diode Short Protection
 - ◆ Output Short Circuit Protection
 - ◆ Thermal Shutdown
 - ◆ Line over Voltage Protection
- This is a Pb-Free Device

Typical Applications

- Integral LED Bulbs
- LED Power Driver Supplies
- LED Light Engines

MARKING DIAGRAM

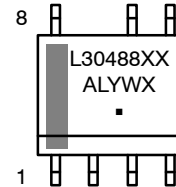

L30488 = Specific Device Code
 XX = Version
 A = Assembly Location
 L = Wafer Lot
 YW = Assembly Start Week
 ■ = Pb-Free Package

PIN CONNECTIONS

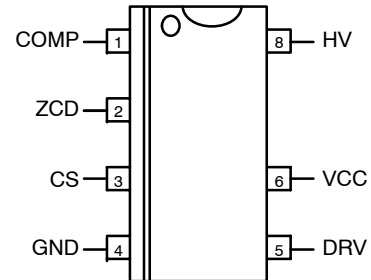

ORDERING INFORMATION

See detailed ordering and shipping information on page 26 of this data sheet.

This document contains information on a product under development. onsemi reserves the right to change or discontinue this product without notice.

NCL30488B

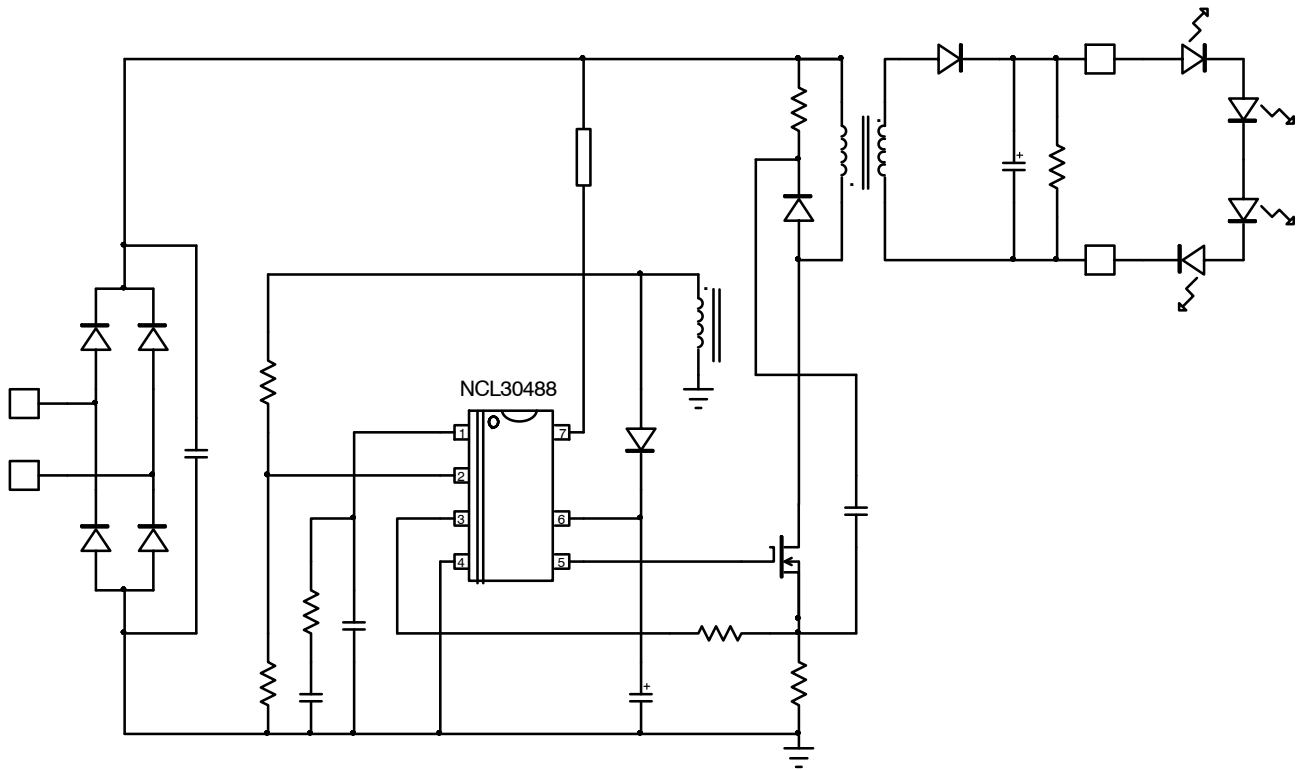

Figure 1. Typical Application Schematic for NCL30488B

PIN FUNCTION DESCRIPTION NCL30488B

Pin N°	Pin Name	Function	Pin Description
1	COMP	OTA output for CV loop	This pin receives a compensation network (capacitors and resistors) to stabilize the CV loop
2	ZCD	Zero crossing Detection V_{aux} sensing	This pin connects to the auxiliary winding and is used to detect the core reset event. This pin also senses the auxiliary winding voltage for accurate output voltage control.
3	CS	Current sense	This pin monitors the primary peak current.
4	GND	-	The controller ground
5	DRV	Driver output	The driver's output to an external MOSFET
6	VCC	Supplies the controller	This pin is connected to an external auxiliary voltage.
7	NC	creepage	
8	HV	High Voltage sensing	This pin connects after the diode bridge to provide the startup current and internal high voltage sensing function.

NCL30488B

INTERNAL CIRCUIT ARCHITECTURE

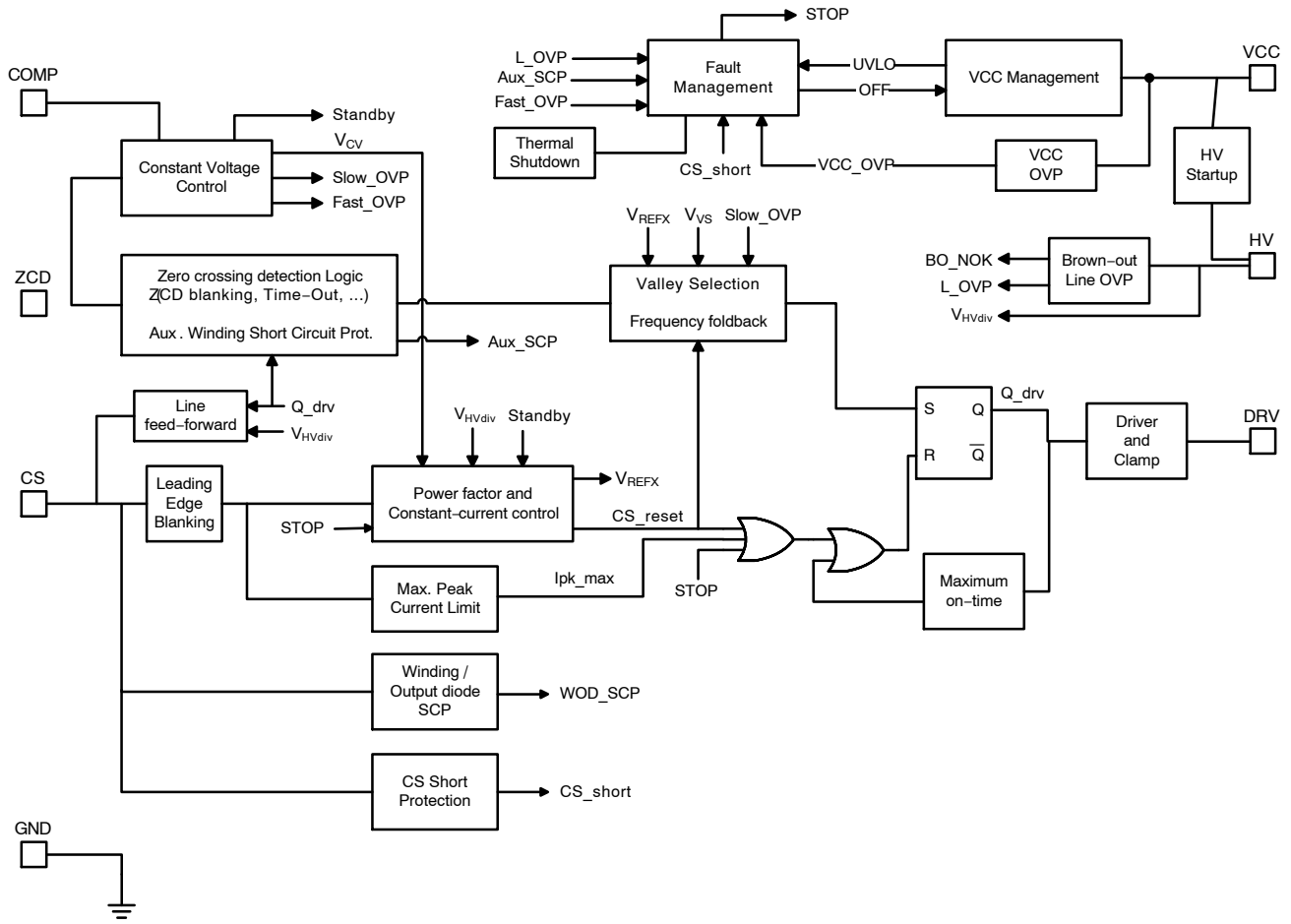

Figure 2. Internal Circuit Architecture NCL30488B

MAXIMUM RATINGS TABLE

Symbol	Rating	Value	Unit
V _{CC(MAX)} I _{CC(MAX)}	Maximum Power Supply Voltage, VCC Pin, Continuous Voltage Maximum Current for VCC Pin	-0.3 to 30 Internally limited	V mA
V _{DRV(MAX)} I _{DRV(MAX)}	Maximum Driver Pin Voltage, DRV Pin, Continuous Voltage Maximum Current for DRV Pin	-0.3, V _{DRV} (Note 1) -300, +500	V mA
V _{HV(MAX)} I _{HV(MAX)}	Maximum Voltage on HV Pin Maximum Current for HV Pin (dc Current Self-limited if Operated within the Allowed Range)	-0.3, +700 ±20	V mA
V _{MAX} I _{MAX}	Maximum Voltage on Low Power Pins (Except Pins DRV and VCC) Current Range for Low Power Pins (Except Pins DRV and VCC)	-0.3, 5.5 (Note 2) -2, +5	V mA
R _{θJ-A}	Thermal Resistance Junction-to-Air	200	°C/W
T _{J(MAX)}	Maximum Junction Temperature	150	°C
	Operating Temperature Range	-40 to +125	°C
	Storage Temperature Range	-60 to +150	°C
	ESD Capability, HBM Model Except HV Pin (Note 3)	4	kV
	ESD Capability, HBM Model HV Pin	1.5	kV
	ESD Capability, CDM Model (Note 3)	1	kV

Stresses exceeding those listed in the Maximum Ratings table may damage the device. If any of these limits are exceeded, device functionality should not be assumed, damage may occur and reliability may be affected.

- V_{DRV} is the DRV clamp voltage V_{DRV(high)} when V_{CC} is higher than V_{DRV(high)}. V_{DRV} is V_{CC} otherwise.
- This level is low enough to guarantee not to exceed the internal ESD diode and 5.5 V ZENER diode. More positive and negative voltages can be applied if the pin current stays within the -2 mA / 5 mA range.
- This device series contains ESD protection and exceeds the following tests: Human Body Model 4000 V per Mil-Std-883, Method 3015. Charged Device Model 1000 V per JEDEC Standard JESD22-C101D.
- This device contains latch-up protection and exceeds 100 mA per JEDEC Standard JESD78.

ELECTRICAL CHARACTERISTICS (Unless otherwise noted: For typical values T_J = 25°C, V_{CC} = 12 V, V_{ZCD} = 0 V, V_{CS} = 0 V. For min/max values T_J = -40°C to +125°C, Max T_J = 150°C, V_{CC} = 12 V)

Parameter	Test Condition	Symbol	Min	Typ	Max	Unit
-----------	----------------	--------	-----	-----	-----	------

HIGH VOLTAGE SECTION

High Voltage Current Source	V _{CC} = V _{CC(on)} - 200 mV	I _{HV(start2)}	3.4	4.6	6.2	mA
High Voltage Current Source	V _{CC} = 0 V	I _{HV(start1)}	-	300	-	µA
V _{CC} Level for I _{HV(start1)} to I _{HV(start2)} Transition		V _{CC(TH)}	-	0.8	-	V
Minimum Startup Voltage	V _{CC} = 0 V	V _{HV(MIN)}	-	15	-	V
HV Source Leakage Current	V _{HV} = 450 V	I _{HV(leak)}	-	4.5	10	µA
Maximum Input Voltage (rms) for Correct Operation of the PFC Loop		V _{HV(OL)}	320	-	-	V rms

SUPPLY SECTION

Supply Voltage Startup Threshold Minimum Operating Voltage Hysteresis V _{CC(on)} - V _{CC(off)} Internal Logic Reset	V _{CC} increasing V _{CC} decreasing V _{CC} decreasing	V _{CC(on)} V _{CC(off)} V _{CC(HYS)} V _{CC(reset)}	16 9.3 7.6 4	18 10.2 - 5	20 10.7 - 6	V
Over Voltage Protection VCC OVP Threshold		V _{CC(OVP)}	25	26.5	28	V
V _{CC(off)} Noise Filter (Note 5) V _{CC(reset)} Noise Filter (Note 5)		t _{VCC(off)} t _{VCC(reset)}	- -	5 20	- -	µs
Supply Current Device Disabled/Fault Device Enabled/No Output Load on Pin 5 Device Switching (F _{sw} = 65 kHz) Device switching (F _{sw} = 700 Hz)	V _{CC} > V _{CC(off)} F _{sw} = 65 kHz C _{DRV} = 470 pF, F _{sw} = 65 kHz V _{COMP} ≤ 0.9 V	I _{CC1} I _{CC2} I _{CC3} I _{CC4}	1.1 - - -	1.4 3.3 3.6 1.7	1.7 3.9 4.3 2	mA

NCL30488B

ELECTRICAL CHARACTERISTICS (Unless otherwise noted: For typical values $T_J = 25^\circ\text{C}$, $V_{CC} = 12\text{ V}$, $V_{ZCD} = 0\text{ V}$, $V_{CS} = 0\text{ V}$. For min/max values $T_J = -40^\circ\text{C}$ to $+125^\circ\text{C}$, Max $T_J = 150^\circ\text{C}$, $V_{CC} = 12\text{ V}$) (continued)

Parameter	Test Condition	Symbol	Min	Typ	Max	Unit
CURRENT SENSE						
Maximum Internal Current Limit		V_{ILIM}	1.28	1.40	1.50	V
Leading Edge Blanking Duration for V_{ILIM}		t_{LEB}	240	300	360	ns
Propagation Delay from Current Detection to Gate Off-state		t_{LIM}	–	50	150	ns
Maximum On-time OPN1		$t_{on(MAX)1}$	10.5	14.0	17.5	μs
Maximum On-time OPN2		$t_{on(MAX)2}$	16	20	24	μs
Maximum On-time $V_{REFX} < 0.15\text{ V}$ (OPN1)		$t_{on(MAX)12}$	5.3	7.0	8.7	μs
Maximum On-time $V_{REFX} < 0.15\text{ V}$ (OPN2)		$t_{on(MAX)22}$	8	10	12	μs
Threshold for Immediate Fault Protection Activation (140% of V_{ILIM})		$V_{CS(stop)}$	1.9	2.0	2.1	V
Leading Edge Blanking Duration for $V_{CS(stop)}$		t_{BCS}	–	170	–	ns
Current Source for CS to GND Short Detection		$I_{CS(short)}$	400	500	600	μA
Current Sense Threshold for CS to GND Short Detection	V_{CS} rising	$V_{CS(low)}$	20	60	90	mV
Maximum Peak Current in Standby Mode Option 1 Option 2 Option 3		$V_{CS(SBY)}$	342 297 252	380 330 280	418 363 308	mV

GATE DRIVE

Drive Resistance DRV Sink DRV Source		R_{SNK} R_{SRC}	– –	13 30	– –	Ω
Drive Current Capability DRV Sink (Note GBD) DRV Source (Note GBD)		I_{SNK} I_{SRC}	– –	500 300	– –	mA
Rise Time (10% to 90%)	$C_{DRV} = 470\text{ pF}$	t_r	–	30	–	ns
Fall Time (90 % to 10%)	$C_{DRV} = 470\text{ pF}$	t_f	–	20	–	ns
DRV Low Voltage	$V_{CC} = V_{CC(off)} + 0.2\text{ V}$ $C_{DRV} = 470\text{ pF}$, $R_{DRV} = 33\text{ k}\Omega$	$V_{DRV(low)}$	8	–	–	V
DRV High Voltage	$V_{CC} = V_{CC(MAX)}$ $C_{DRV} = 470\text{ pF}$, $R_{DRV} = 33\text{ k}\Omega$	$V_{DRV(high)}$	10	12	14	V

ZERO VOLTAGE DETECTION CIRCUIT

Upper ZCD Threshold Voltage	V_{ZCD} rising	$V_{ZCD(rising)}$	–	90	150	mV
Lower ZCD Threshold Voltage	V_{ZCD} falling	$V_{ZCD(falling)}$	35	55	–	mV
Threshold to Force V_{REFX} Maximum During Startup	V_{ZCD} falling	$V_{ZCD(start)}$	–	0.7	–	V
ZCD Hysteresis		$V_{ZCD(HYS)}$	15	–	–	mV
Propagation Delay from Valley Detection to DRV High	V_{ZCD} decreasing	$t_{ZCD(DEM)}$	–	–	150	ns
Equivalent Time Constant for ZCD Input (GBD)		t_{PAR}	–	20	–	ns
Blanking Delay After On-time (Option 1)	$V_{REFX} > 0.35\text{ V}$	$t_{ZCD(blank1)}$	1.1	1.5	1.9	μs
Blanking Delay After On-time (Option 2)	$V_{REFX} > 0.35\text{ V}$	$t_{ZCD(blank1)}$	0.75	1.0	1.25	μs
Blanking Delay at Light Load (Option 1)	$V_{REFX} < 0.25\text{ V}$	$t_{ZCD(blank2)}$	0.6	0.8	1.0	μs
Blanking Delay at Light Load (Option 2)	$V_{REFX} < 0.25\text{ V}$	$t_{ZCD(blank2)}$	0.45	0.6	0.75	μs
Timeout after Last DEMAG Transition		t_{TIMO}	5	6.5	8	μs
Time-out after Last DEMAG Transition $V_{ZCD} < V_{ZCD(start)}$ (Note 5)		$t_{TIMOstart}$	–	50	–	μs
Pulling-down Resistor	$V_{ZCD} = V_{ZCD(falling)}$	$R_{ZCD(pd)}$	–	200	–	$\text{k}\Omega$

NCL30488B

ELECTRICAL CHARACTERISTICS (Unless otherwise noted: For typical values $T_J = 25^\circ\text{C}$, $V_{CC} = 12\text{ V}$, $V_{ZCD} = 0\text{ V}$, $V_{CS} = 0\text{ V}$. For min/max values $T_J = -40^\circ\text{C}$ to $+125^\circ\text{C}$, Max $T_J = 150^\circ\text{C}$, $V_{CC} = 12\text{ V}$) (continued)

Parameter	Test Condition	Symbol	Min	Typ	Max	Unit
-----------	----------------	--------	-----	-----	-----	------

CONSTANT CURRENT CONTROL

Reference Voltage	$T_J = 25^\circ\text{C} - 85^\circ\text{C}$	$V_{REF/3}$	327.9	334.2	341.2	mV
Reference Voltage	$T_J = -40^\circ\text{C}$ to 125°C	$V_{REF/3}$	324.1	334.2	346.0	mV
Current Sense Lower Threshold for Detection of the Leakage Inductance Reset Time	V_{CS} falling	$V_{CS(low)}$	20	50	100	mV
Blanking Time for Leakage Inductance Reset Detection		$t_{CS(low)}$	-	120	-	ns

POWER FACTOR CORRECTION

Clamping Value for $V_{REF(PFC)}$	$T_J = 0^\circ\text{C}$ to 125°C	$V_{REF(PFC)CLP}$	2.06	2.2	2.34	V
Line Range Detector for PFC Loop	V_{HV} increases	$V_{HL(PFC)}$	-	240	-	V dc
Line Range Detector for PFC Loop	V_{HV} decreases	$V_{LL(PFC)}$	-	230	-	V dc

CONSTANT VOLTAGE SECTION

Internal Voltage Reference for Constant Voltage Regulation		$V_{REF(CV)}$	3.41	3.52	3.63	V
CV Error Amplifier Gain		G_{EA}	40	50	60	μS
Error Amplifier Current Capability	$V_{REFX} = V_{REF}$ (no dimming)	I_{EA}	-	± 60	-	μA
COMP Pin Lower Clamp Voltage		$V_{CV(clampL)}$	-	0.6	-	V
COMP Pin Higher Clamp Voltage	$T_J = 0^\circ\text{C}$ to 125°C	$V_{CV(clampH)}$	4.05	4.12	4.25	V
COMP Pin Higher Clamp Voltage	$T_J = -40^\circ\text{C}$ to 125°C	$V_{CV(clampH)}$	4.01	4.12	4.25	V
Internal ZCD Voltage below which the CV OTA is Boosted	$V_{REF(CV)} * 85\%$	$V_{boost(CV)}$	2.796	2.975	3.154	V
Threshold for Releasing the Boost	$V_{REF(CV)} * 90\%$	$V_{boost(CV)RST}$	2.96	3.15	3.34	V
Error Amplifier Current Capability During Boost Phase		I_{Eboost}	-	± 140	-	μA
ZCD OVP 1 st Level (Slow OVP) Option 1	$V_{REF(CV)} * 115\%$	V_{OVP1}	3.783	4.025	4.267	V
ZCD Voltage at which Slow OVP is Exit (Option 1)	$V_{REF(CV)} * 105\%$	$V_{OVP1rst}$	-	3.675	-	V
Switching Period During Slow OVP		$T_{sw(OVP1)}$	-	1.5	-	ms
ZCD Fast OVP Option 1	$V_{ref(CV)} * 125\% + 150\text{ mV}$	V_{OVP2}	4.253	4.525	4.797	V
Number of Switching Cycles before Fast OVP Confirmation		T_{OVP2_CNT}	-	4	-	
Duration for Disabling DRV Pulses During ZCD Fast OVP		$T_{recovery}$	-	4	-	s
COMP Pin Voltage below which Standby Mode is Entered (Note 5)	V_{COMP} decreasing	$V_{CMP(SBY)}$	-	0.895	-	V
COMP Standby Comparator Hysteresis (Note 5)	V_{COMP} increasing	$V_{CMP(SBY)HYS}$	-	18	-	mV
COMP Pin Internal Pullup Resistor (SSR Option)		R_{pullup}	-	15	-	k Ω

LINE FEED FORWARD

V_{HV} to $I_{CS(offset)}$ Conversion Ratio		K_{LFF}	0.189	0.21	0.231	$\mu\text{A/V}$
Offset Current Maximum Value	$V_{HV} > (450\text{ V or } 500\text{ V})$	$I_{offset(MAX)}$	76	95	114	μA
Line Feed-forward Current	DRV high, $V_{HV} = 200\text{ V}$	I_{FF}	35	40	45	μA

VALLEY LOCKOUT SECTION

Threshold for Line Range Detection V_{HV} Increasing (1 st to 2 nd Valley Transition for $V_{REFX} > 80\% V_{REF}$) (Prog. Option: 1 st to 3 rd Valley Transition)	V_{HV} increases	V_{HL}	228	240	252	V
Threshold for Line Range Detection V_{HV} Decreasing (2 nd to 1 st Valley Transition for $V_{REFX} > 80\% V_{REF}$) (Prog. Option: 3 rd to 1 st Valley Transition)	V_{HV} decreases	V_{LL}	218	230	242	V
Blanking Time for Line Range Detection		$t_{HL(blank)}$	15	25	35	ms

NCL30488B

ELECTRICAL CHARACTERISTICS (Unless otherwise noted: For typical values $T_J = 25^\circ\text{C}$, $V_{CC} = 12\text{ V}$, $V_{ZCD} = 0\text{ V}$, $V_{CS} = 0\text{ V}$. For min/max values $T_J = -40^\circ\text{C}$ to $+125^\circ\text{C}$, Max $T_J = 150^\circ\text{C}$, $V_{CC} = 12\text{ V}$) (continued)

Parameter	Test Condition	Symbol	Min	Typ	Max	Unit
-----------	----------------	--------	-----	-----	-----	------

VALLEY LOCKOUT SECTION

Valley Thresholds 1 st to 2 nd Valley Transition at LL and 2 nd to 3 rd Valley HL, V_{REF} Decr. (Prog. Option: 3 rd to 4 th Valley HL)	V_{REF} decreases	$V_{VLY1-2/2-3}$	-	0.80	-	V
2 nd to 1 st Valley Transition at LL and 3 rd to 2 nd Valley HL, V_{REF} Incr. (Prog. Option: 4 th to 3 rd Valley HL)	V_{REF} increases	$V_{VLY2-1/3-2}$	-	0.90	-	V
2 nd to 3 rd Valley Transition at LL and 3 rd to 4 th Valley HL, V_{REF} Decr. (Prog. Option: 4 th to 5 th Valley HL)	V_{REF} decreases	$V_{VLY2-3/3-4}$	-	0.65	-	V
3 rd to 2 nd Valley Transition at LL and 4 th to 3 rd Valley HL, V_{REF} Incr. (Prog. Option: 5 th to 4 th Valley HL)	V_{REF} increases	$V_{VLY3-2/4-3}$	-	0.75	-	V
3 rd to 4 th Valley Transition at LL and 4 th to 5 th Valley HL, V_{REF} Decr. (Prog. Option: 5 th to 6 th Valley HL)	V_{REF} decreases	$V_{VLY3-4/4-5}$	-	0.50	-	V
4 th to 3 rd Valley Transition at LL and 5 th to 4 th Valley HL, V_{REF} Incr. (Prog. Option: 6 th to 5 th Valley HL)	V_{REF} increases	$V_{VLY4-3/5-4}$	-	0.60	-	V
4 th to 5 th Valley Transition at LL and 5 th to 6 th Valley HL, V_{REF} Decr. (Prog. Option: 6 th to 7 th Valley HL)	V_{REF} decreases	$V_{VLY4-5/5-6}$	-	0.35	-	V
5 th to 4 th Valley Transition at LL and 6 th to 5 th Valley HL, V_{REF} Incr. (Prog. Option: 7 th to 6 th Valley HL)	V_{REF} increases	$V_{VLY5-4/6-5}$	-	0.45	-	V
V_{REF} Value at which the FF Mode is Activated	V_{REF} decreases	$V_{FFstart}$	-	0.25	-	V
V_{REF} Value at which the FF Mode is Removed	V_{REF} increases	V_{FFstop}	-	0.35	-	V

FREQUENCY FOLDBACK

Added Dead time (Note 5)	$V_{REFX} = 0.25\text{ V}$	t_{FF1LL}	-	2	-	μs
Added Dead Time (Note 5)	$V_{REFX} = 0.08\text{ V}$	t_{FFchg}	-	35	-	μs
Dead-time Clamp (Option 1) (Note 5)	$V_{REFX} < 3\text{ mV}$	t_{FFend1}	-	687	-	μs
Dead-time Clamp (Option 2) (Note 5)	$V_{REFX} < 11.2\text{ mV}$	t_{FFend2}	-	250	-	μs
Minimum Added Dead-time in Standby (Note 5)	$V_{REFX} = 0$	$t_{DT(min)SBY}$	-	640	-	μs
Maximum Added Dead-time in Standby (Option 2) (Note 5)	$V_{REFX} = 0, V_{COMP} < 0.7\text{ V}$	$t_{DT(max)SBY2}$	-	1.8	-	ms
V_{REFX} Threshold below which Valley Synchronization in Frequency Foldback is Turned Off (Note 5)	V_{REFX} decreasing	$V_{REFXsyncD}$	0.14	0.15	0.16	V
V_{REFX} Threshold above which Valley Synchronization in Frequency Foldback is Turned On (Note 5)	V_{REFX} increasing	$V_{REFXsyncI}$	0.165	0.18	0.195	V

FAULT PROTECTION

Thermal Shutdown (Note 5)	Device switching (F_{SW} around 65 kHz)	T_{SHDN}	130	150	170	$^\circ\text{C}$
Thermal Shutdown Hysteresis		$T_{SHDN(HYS)}$	-	20	-	$^\circ\text{C}$
Threshold Voltage for Output Short Circuit or Aux. Winding Short Circuit Detection		$V_{ZCD(short)}$	0.6	0.65	0.7	V
Short Circuit Detection Timer	$V_{ZCD} < V_{ZCD(short)}$	t_{OVLD}	70	90	110	ms
Auto-recovery Timer		$t_{recovery}$	3	4	5	s
Line OVP Threshold	V_{HV} increasing	$V_{HV(OVP)}$	457	469	485	V dc
HV Pin Voltage at which Line OVP is Reset	V_{HV} decreasing	$V_{HV(OVP)RST}$	430	443	465	V dc
Blanking Time for Line OVP Reset		$T_{LOVP(blank)}$	210	340	470	ms

BROWN-OUT AND LINE SENSING

Brown-Out ON level (IC Start Pulsing)	V_{HV} increasing	$V_{HVBO(on)}$	101.5	108	114.5	V dc
Brown-Out ON Level (IC Start Pulsing) Option 2	V_{HV} increasing	$V_{HVBO(on)2}$	129.7	138	146.3	V dc
Brown-Out OFF Level (IC Stops Pulsing)	V_{HV} decreasing	$V_{HVBO(off)}$	92	99	106	V dc
Brown-Out OFF Level (IC Stops Pulsing) Option 2	V_{HV} decreasing	$V_{HVBO(off)2}$	121	129	137	V dc
HV Pin Voltage above which the Sampling of ZCD is Enabled Low Line	V_{HV} decreasing, low line	$V_{sampENLL}$	-	55	-	V

NCL30488B

ELECTRICAL CHARACTERISTICS (Unless otherwise noted: For typical values $T_J = 25^\circ\text{C}$, $V_{CC} = 12\text{ V}$, $V_{ZCD} = 0\text{ V}$, $V_{CS} = 0\text{ V}$. For min/max values $T_J = -40^\circ\text{C}$ to $+125^\circ\text{C}$, Max $T_J = 150^\circ\text{C}$, $V_{CC} = 12\text{ V}$) (continued)

Parameter	Test Condition	Symbol	Min	Typ	Max	Unit
BROWN-OUT AND LINE SENSING						
HV Pin Voltage above which the Sampling of ZCD is Enabled Highline	V_{HV} decreasing, highline	V_{sampENHL}	–	105	–	V
ZCD Sampling Enable Comparator Hysteresis	V_{HV} increasing	V_{sampHYS}	–	5	–	V
BO Comparators Delay		$t_{\text{BO}(\text{delay})}$	–	30	–	μs
Brown-Out Blanking Time		$t_{\text{BO}(\text{blank})}$	15	25	35	ms

Product parametric performance is indicated in the Electrical Characteristics for the listed test conditions, unless otherwise noted. Product performance may not be indicated by the Electrical Characteristics if operated under different conditions.

5. Guaranteed by design.

TYPICAL CHARACTERISTICS

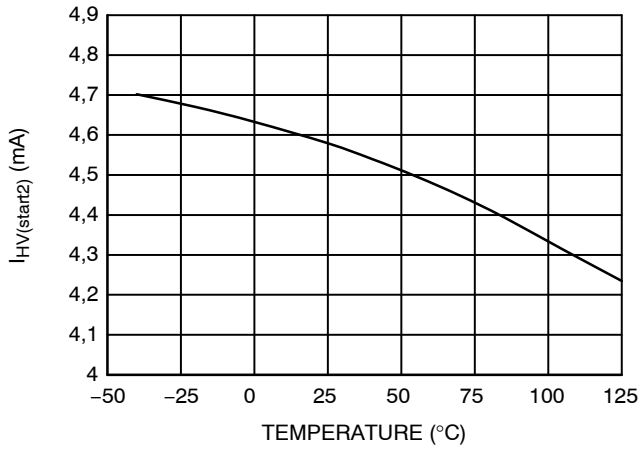

Figure 3. $I_{HV(start2)}$ vs. Temperature

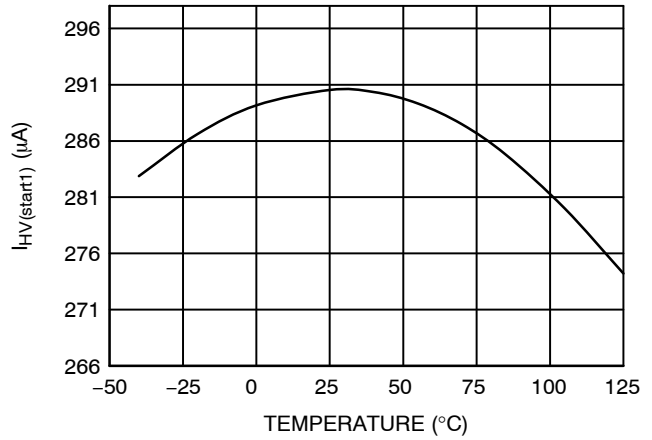

Figure 4. $I_{HV(start1)}$ vs. Temperature

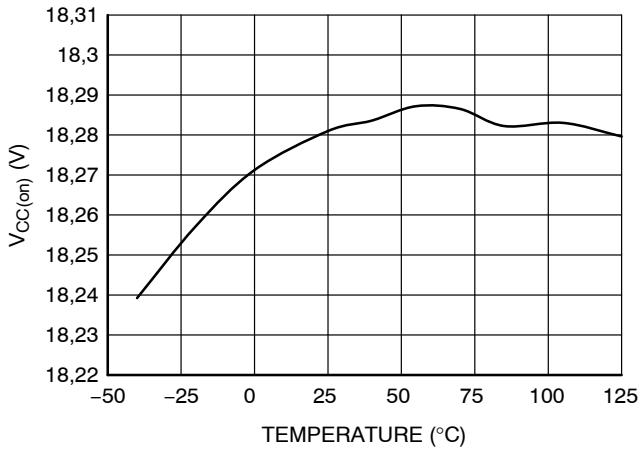

Figure 5. $V_{CC(on)}$ vs. Temperature

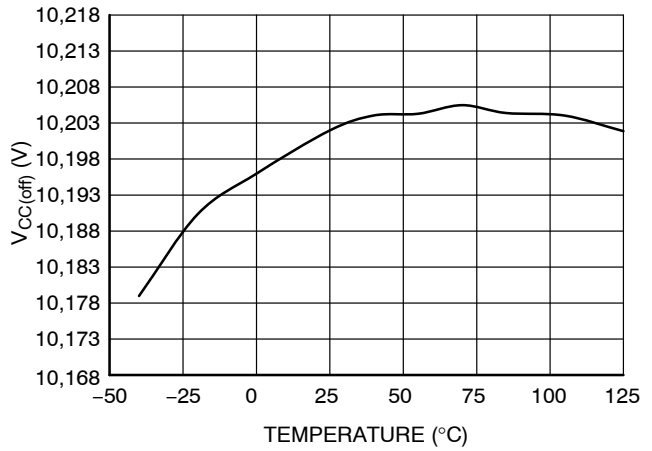

Figure 6. $V_{CC(off)}$ vs. Temperature

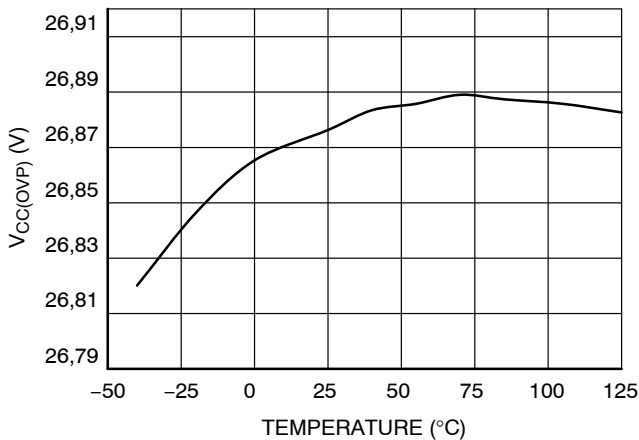

Figure 7. $V_{CC(OVP)}$ vs. Temperature

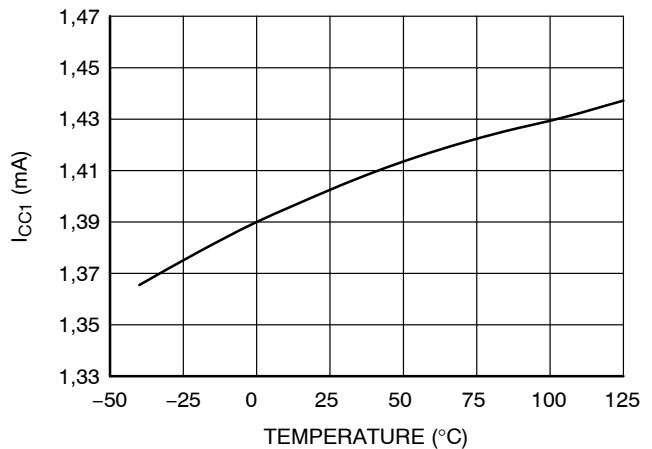

Figure 8. I_{CC1} vs. Temperature

TYPICAL CHARACTERISTICS (continued)

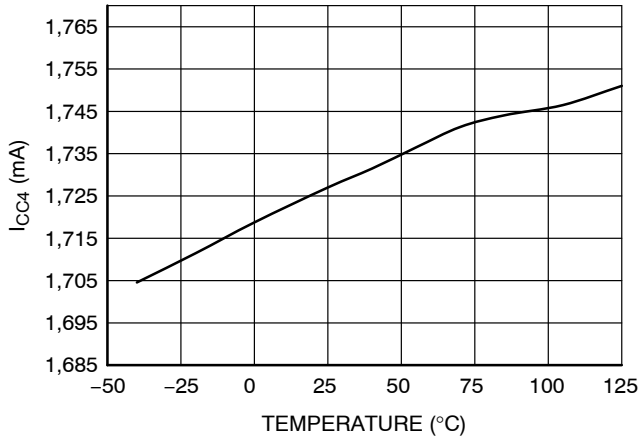

Figure 9. I_{CC4} vs. Temperature

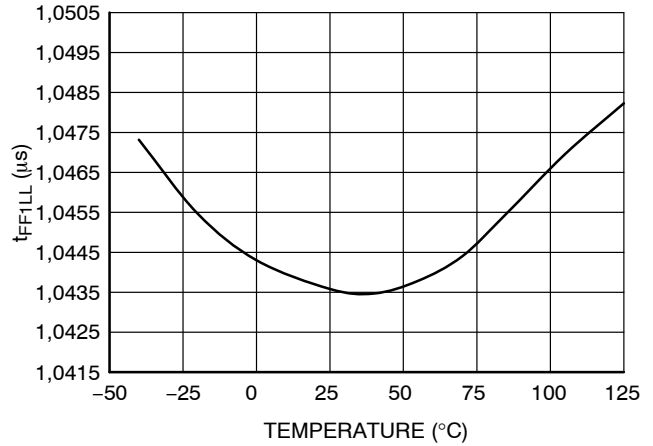

Figure 10. t_{FF1LL} vs. Temperature

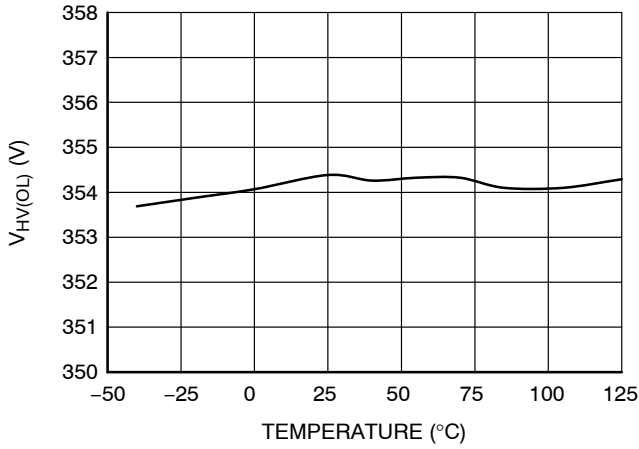

Figure 11. $V_{HV(OL)}$ vs. Temperature

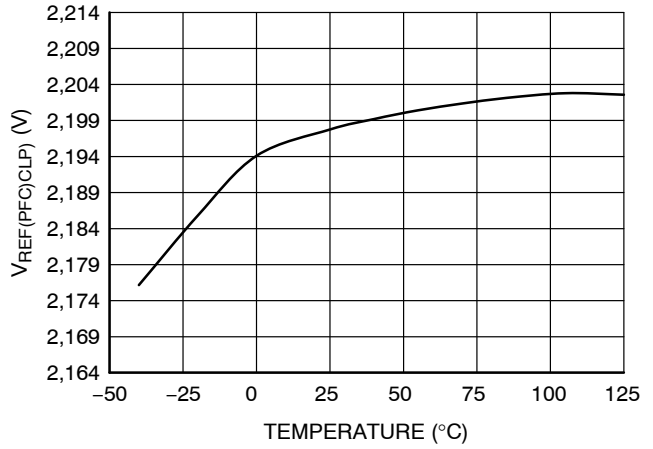

Figure 12. $V_{REF(PFC)CLP}$ vs. Temperature

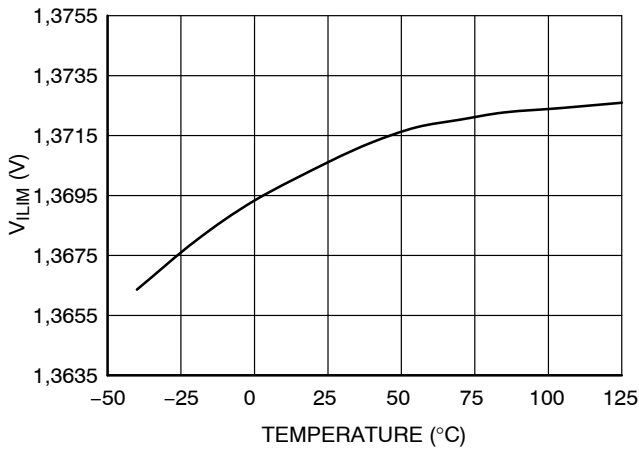

Figure 13. V_{ILIM} vs. Temperature

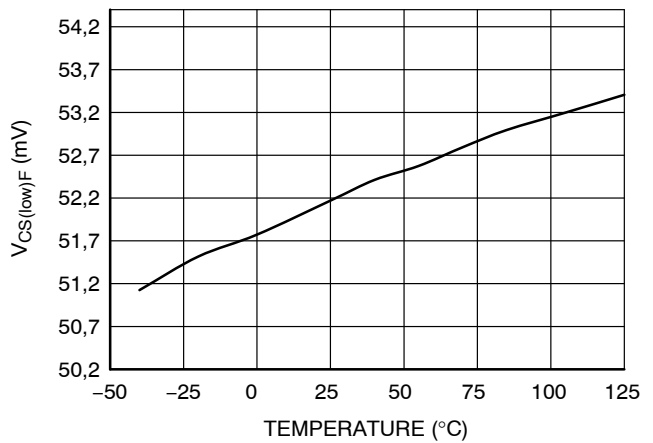

Figure 14. $V_{CS(low)F}$ vs. Temperature

TYPICAL CHARACTERISTICS (continued)

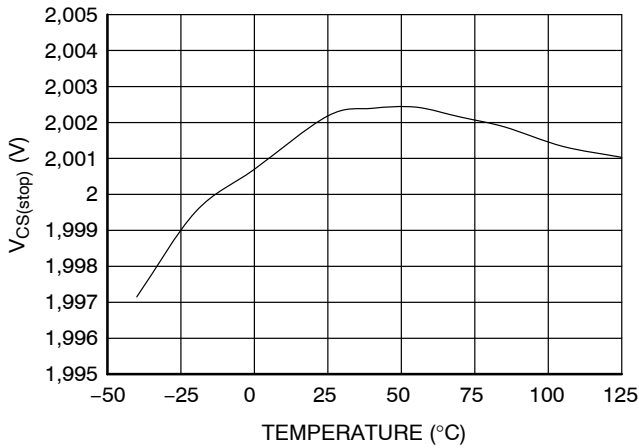

Figure 15. $V_{CS(stop)}$ vs. Temperature

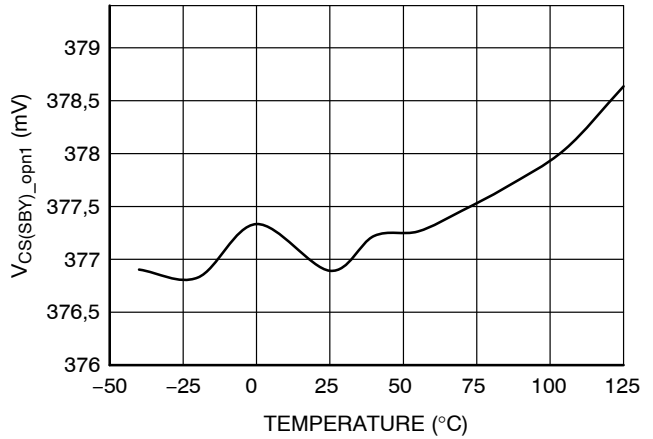

Figure 16. $V_{CS(SBY)_opn1}$ vs. Temperature

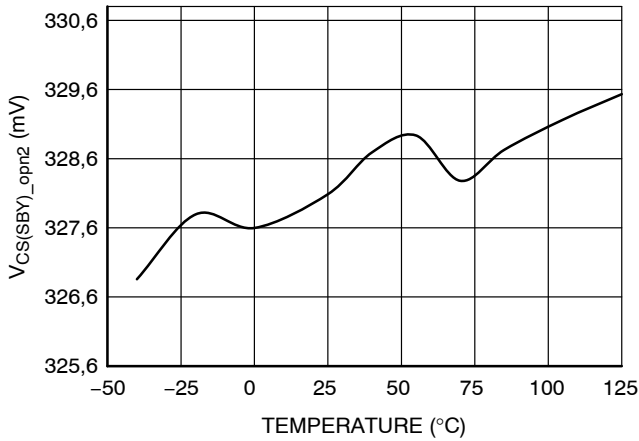

Figure 17. $V_{CS(SBY)_opn2}$ vs. Temperature

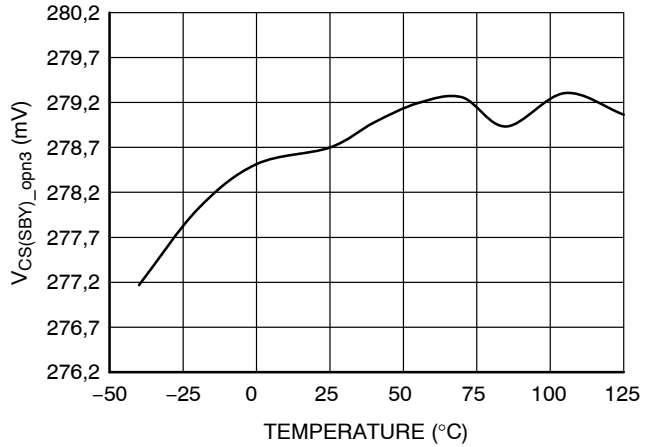

Figure 18. $V_{CS(SBY)_opn3}$ vs. Temperature

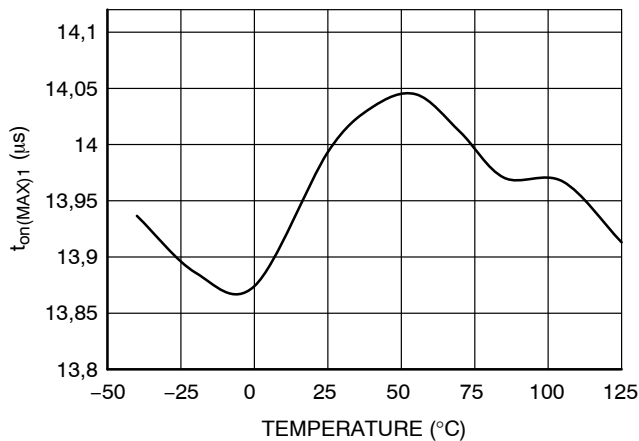

Figure 19. $t_{on(MAX)1}$ vs. Temperature

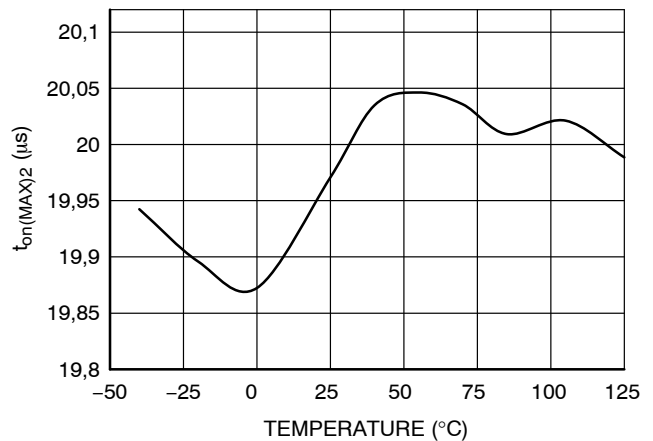

Figure 20. $t_{on(MAX)2}$ vs. Temperature

TYPICAL CHARACTERISTICS (continued)

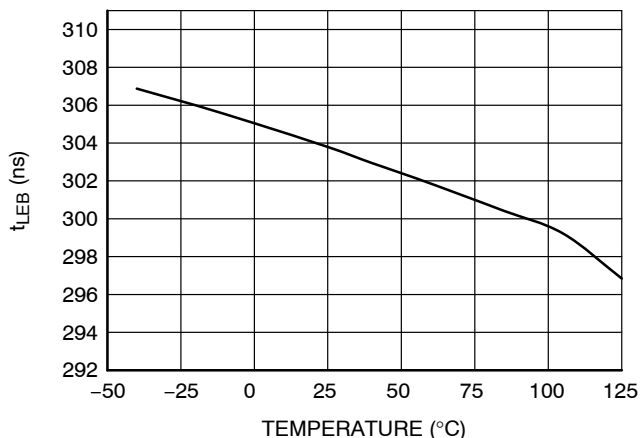

Figure 21. t_{LEB} vs. Temperature

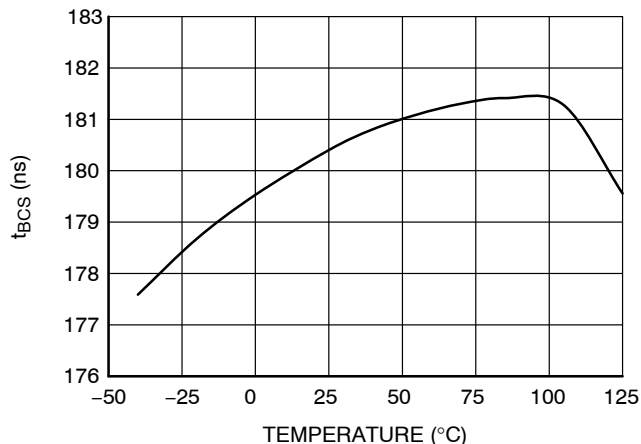

Figure 22. t_{BCS} vs. Temperature

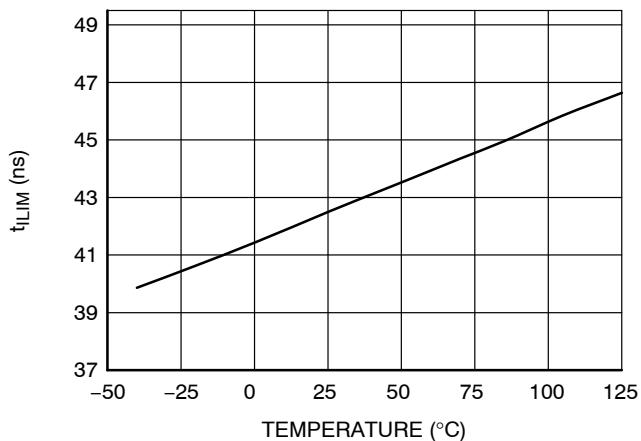

Figure 23. t_{LIM} vs. Temperature

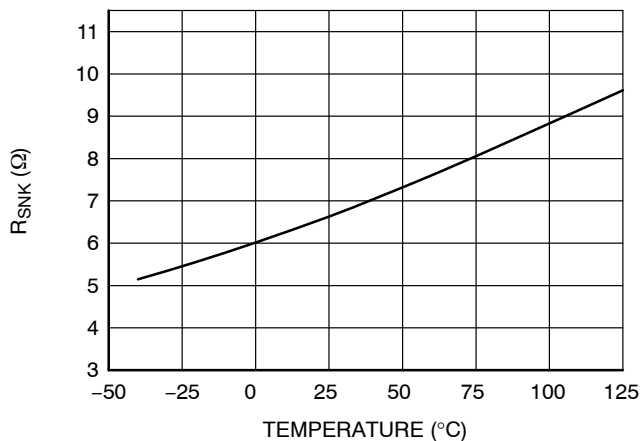

Figure 24. R_{SNK} vs. Temperature

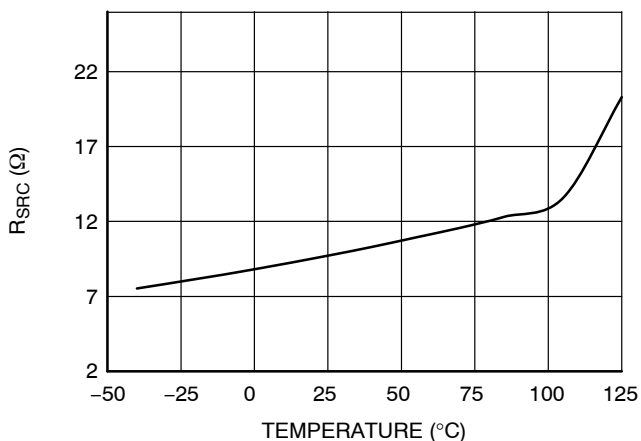

Figure 25. R_{SRC} vs. Temperature

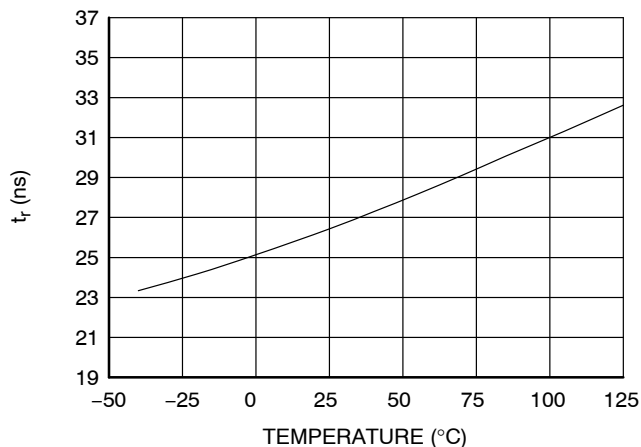

Figure 26. t_r vs. Temperature

TYPICAL CHARACTERISTICS (continued)

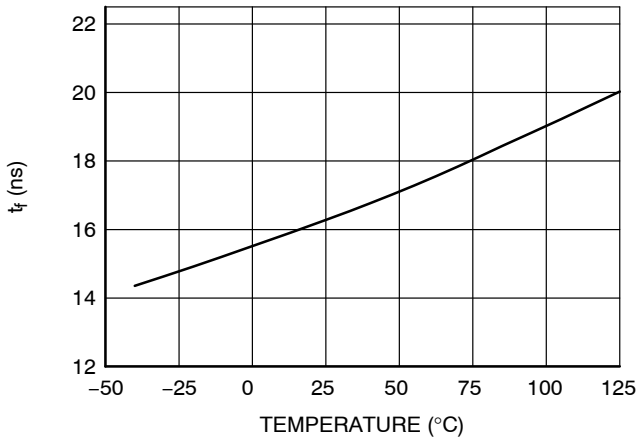

Figure 27. t_f vs. Temperature

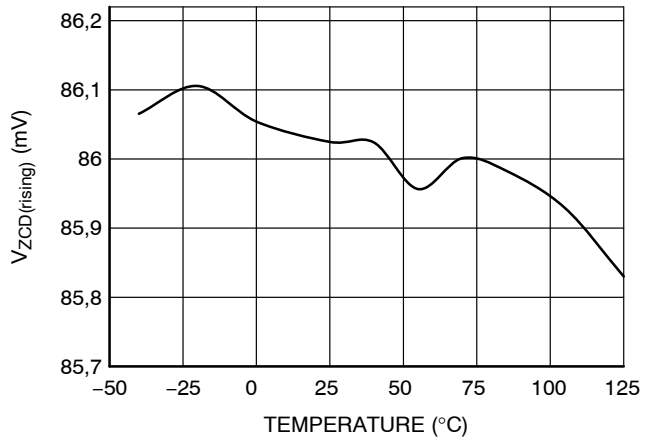

Figure 28. $V_{ZCD(rising)}$ vs. Temperature

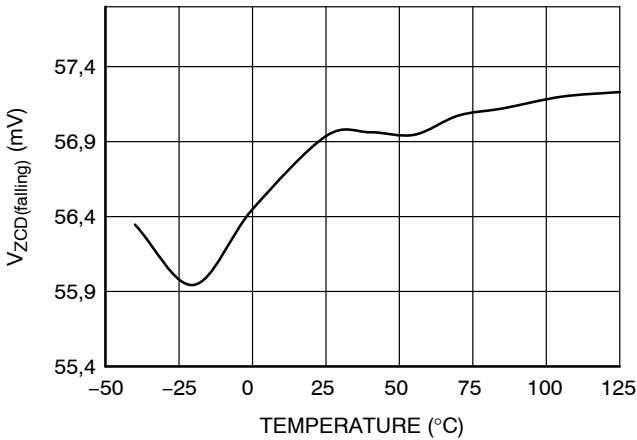

Figure 29. $V_{ZCD(falling)}$ vs. Temperature

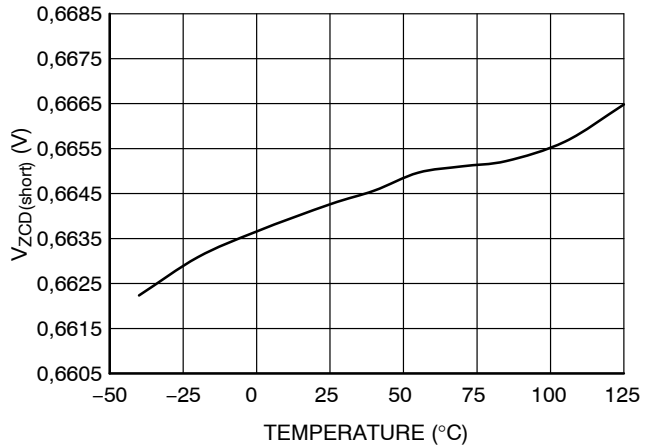

Figure 30. $V_{ZCD(short)}$ vs. Temperature

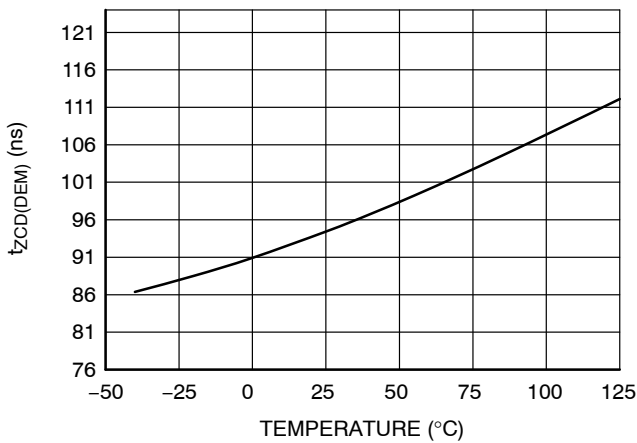

Figure 31. $t_{ZCD(DEM)}$ vs. Temperature

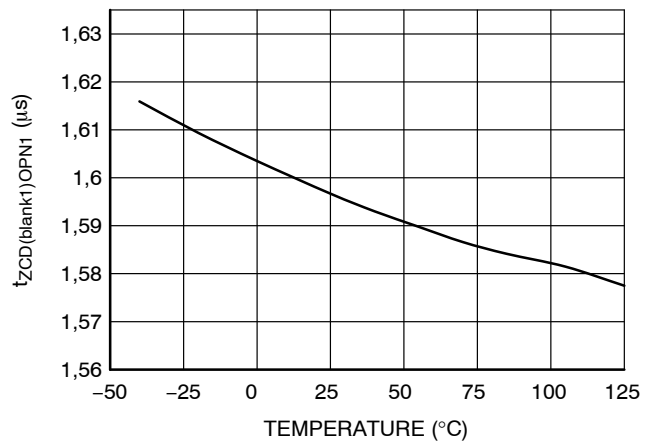

Figure 32. $t_{ZCD(blank1)OPN1}$ vs. Temperature

TYPICAL CHARACTERISTICS (continued)

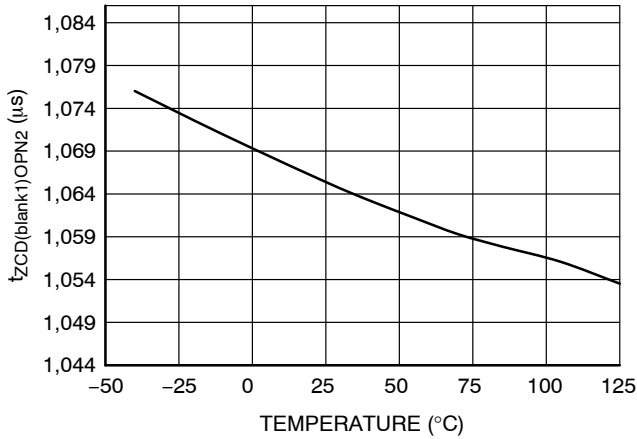

Figure 33. $t_{ZCD(blank1)OPN2}$ vs. Temperature

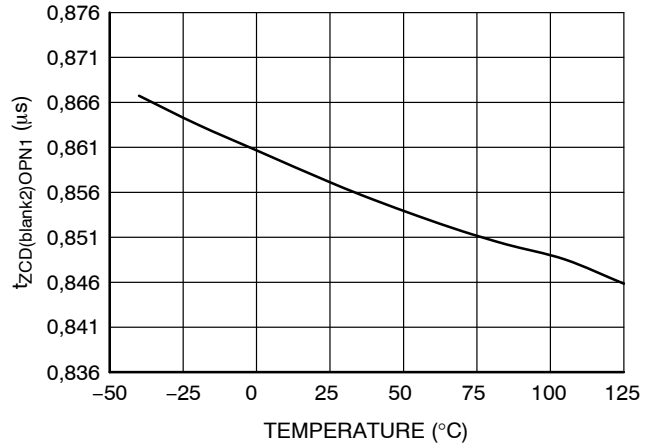

Figure 34. $t_{ZCD(blank2)OPN1}$ vs. Temperature

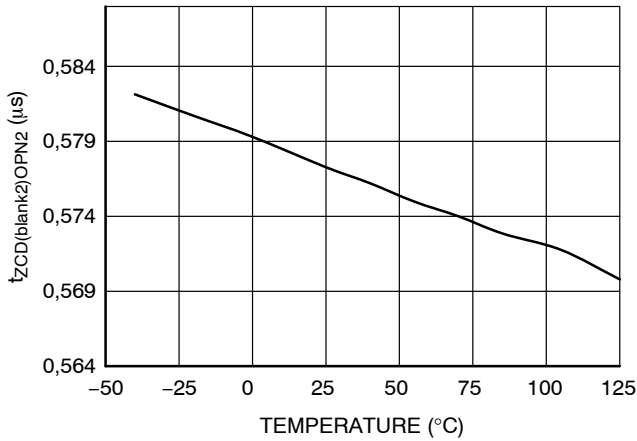

Figure 35. $t_{ZCD(blank2)OPN2}$ vs. Temperature

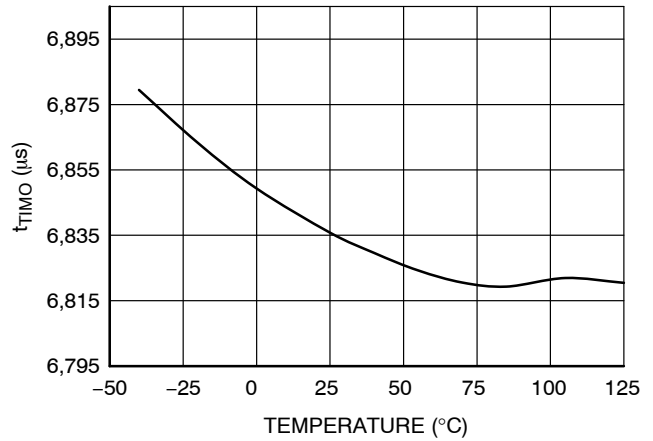

Figure 36. t_{TIMO} vs. Temperature

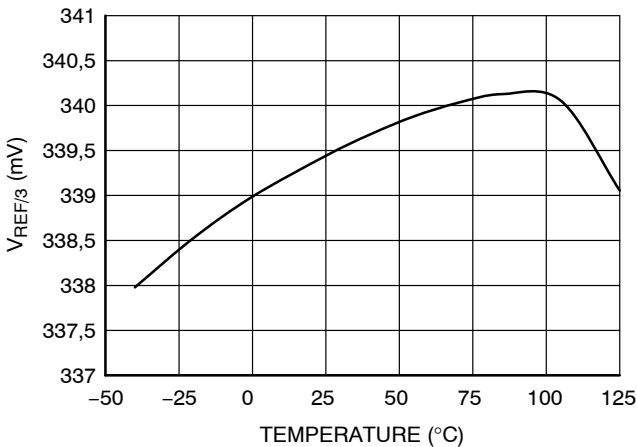

Figure 37. $V_{REF/3}$ vs. Temperature

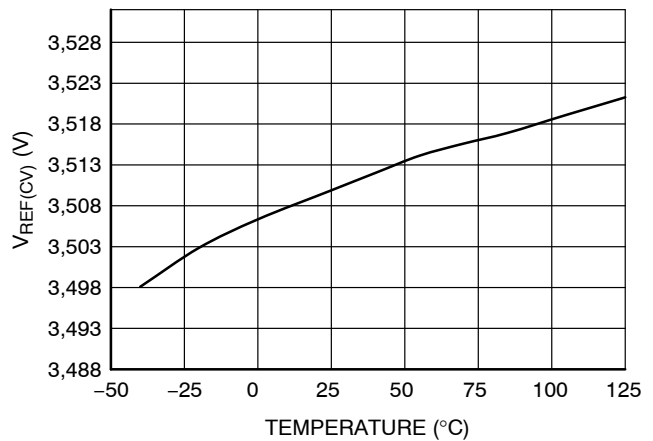

Figure 38. $V_{REF(CV)}$ vs. Temperature

TYPICAL CHARACTERISTICS (continued)

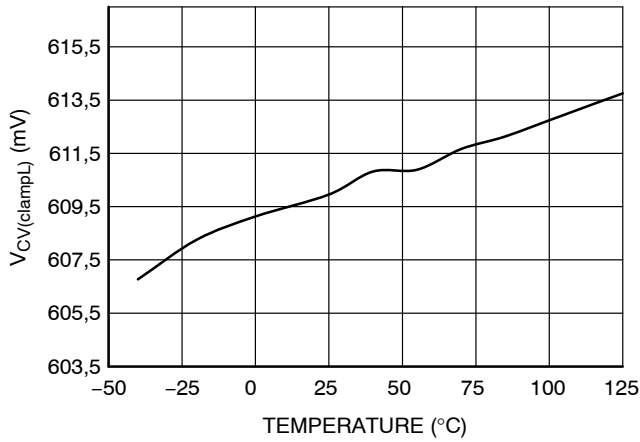

Figure 39. V_{CV(clampL)} vs. Temperature

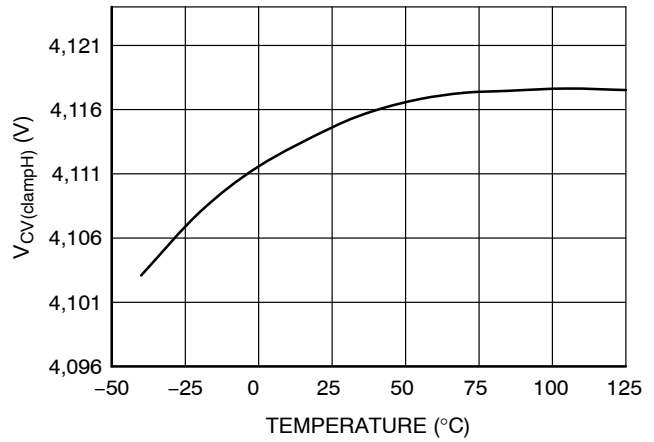

Figure 40. V_{CV(clampH)} vs. Temperature

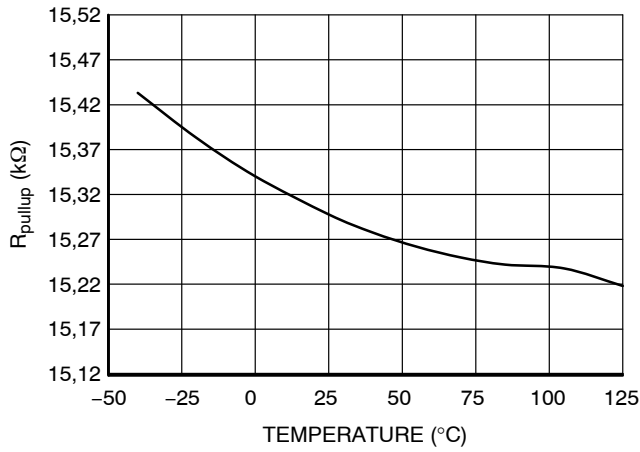

Figure 41. R_{pullup} vs. Temperature

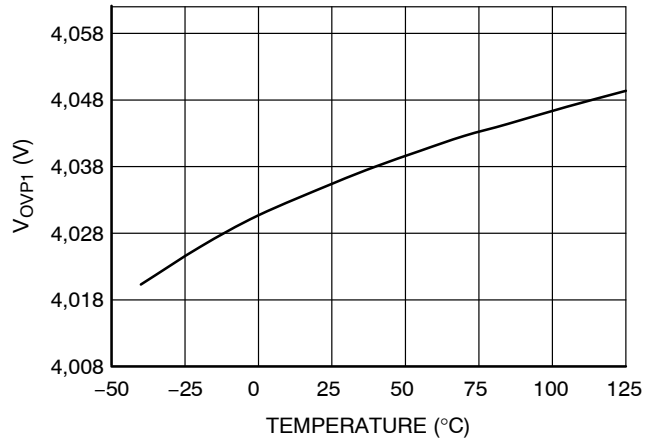

Figure 42. V_{OVP1} vs. Temperature

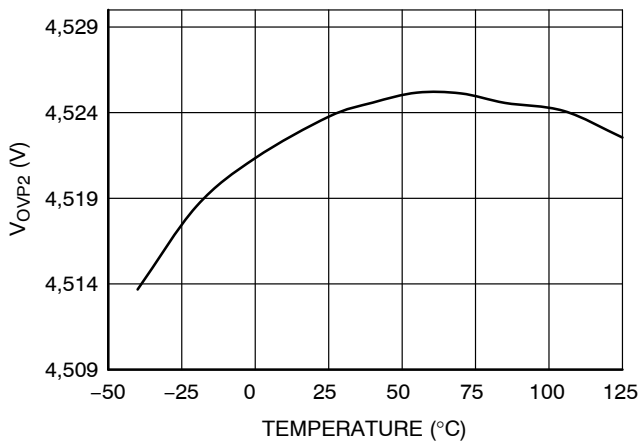

Figure 43. V_{OVP2} vs. Temperature

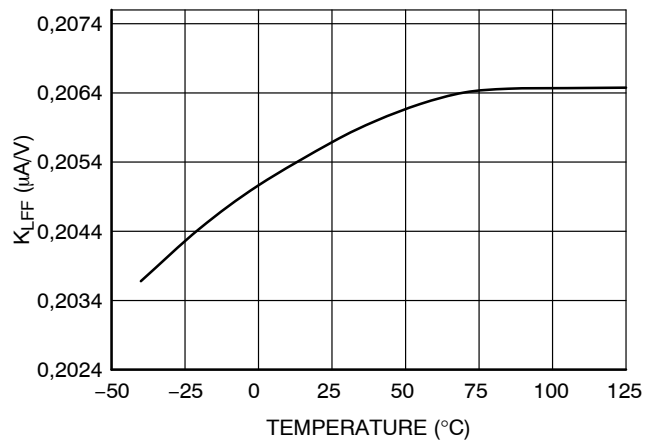

Figure 44. K_{LFF} vs. Temperature

TYPICAL CHARACTERISTICS (continued)

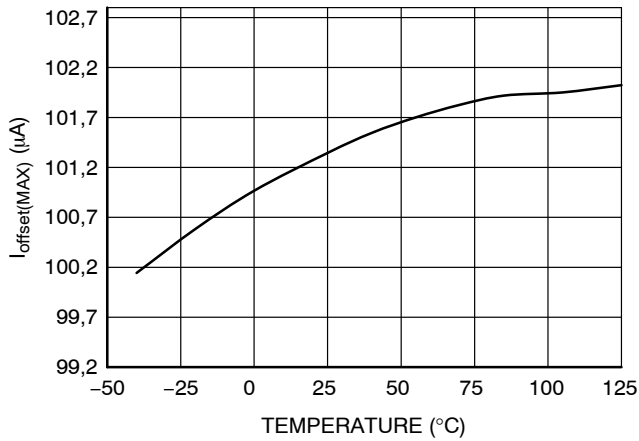

Figure 45. I_{offset(MAX)} vs. Temperature

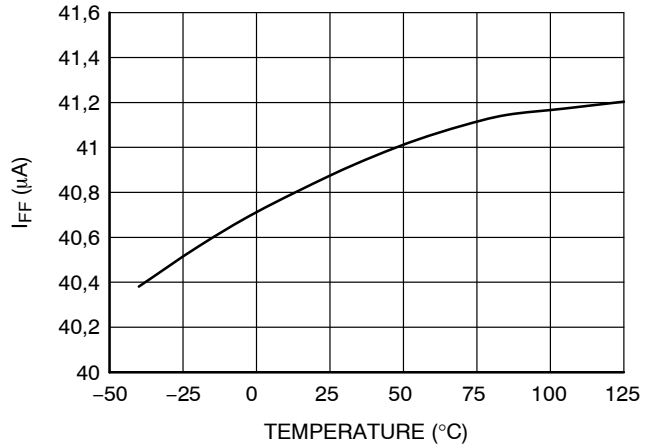

Figure 46. I_{FF} vs. Temperature

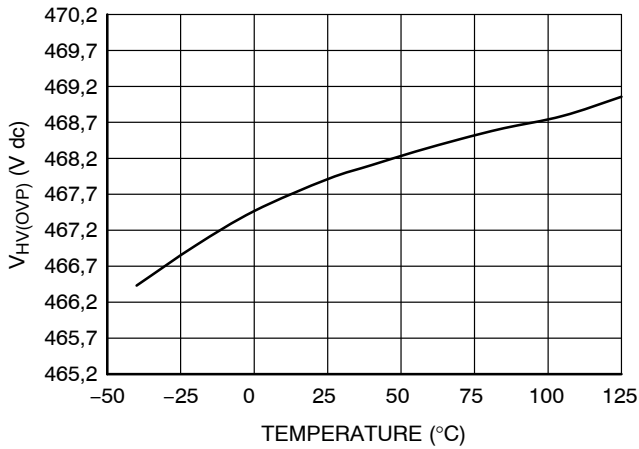

Figure 47. V_{HV(OVP)} vs. Temperature

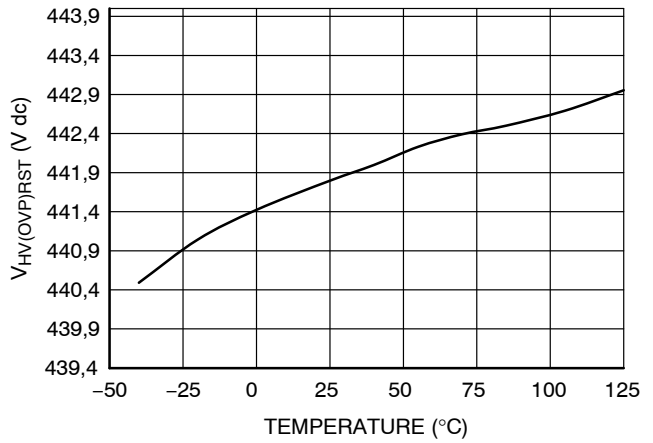

Figure 48. V_{HV(OVP)RST} vs. Temperature

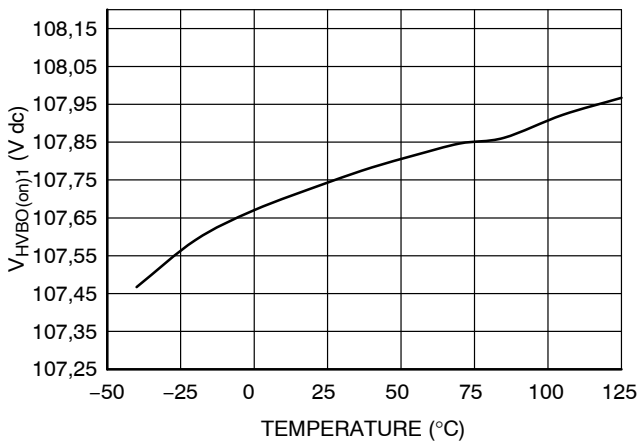

Figure 49. V_{HVBO(on)1} vs. Temperature

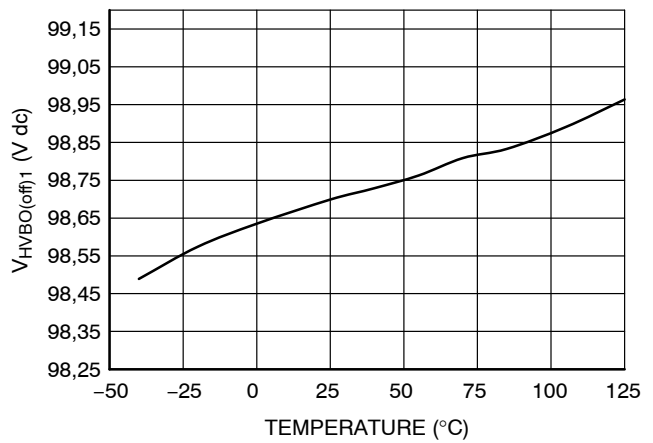

Figure 50. V_{HVBO(off)1} vs. Temperature

TYPICAL CHARACTERISTICS (continued)

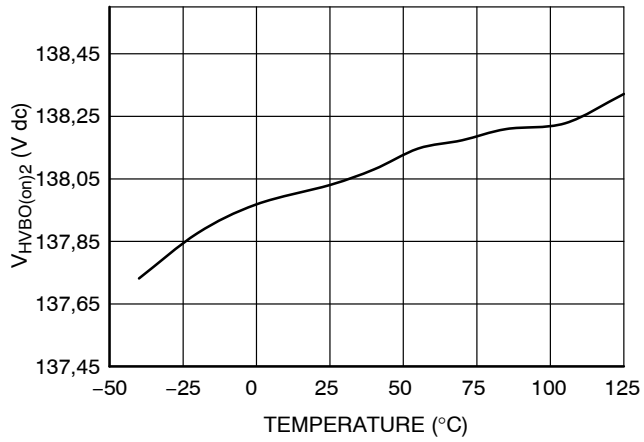

Figure 51. $V_{HVBO(on)2}$ vs. Temperature

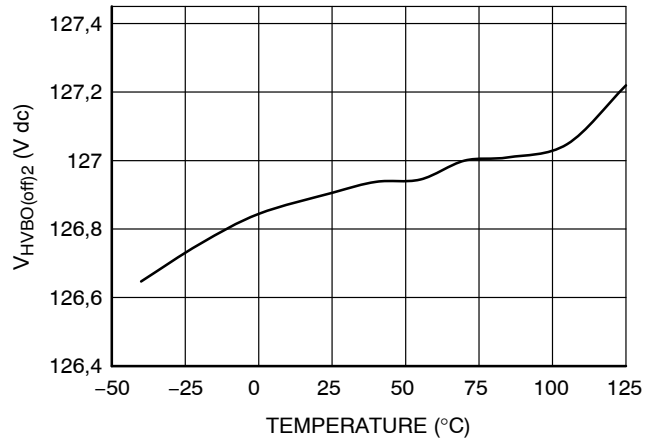

Figure 52. $V_{HVBO(off)2}$ vs. Temperature

Application Information

The NCL30488B implements a current-mode architecture operating in quasi-resonant mode. Thanks to proprietary circuitry, the controller is able to accurately regulate the secondary side current and voltage of the fly-back converter without using any opto-coupler or measuring directly the secondary side current or voltage. The controller provides near unity power factor correction

- *Quasi-Resonance Current-Mode Operation:* implementing quasi-resonance operation in peak current-mode control, the NCL30488B optimizes the efficiency by switching in the valley of the MOSFET drain-source voltage. Thanks to an internal algorithm control, the controller locks-out in a selected valley and remains locked until the input voltage or the output current set point significantly changes.
- *Primary Side Constant Current Control:* thanks to a proprietary circuit, the controller is able to take into account the effect of the leakage inductance of the transformer and allows an accurate control of the secondary side current regardless of the input voltage and output load variation.
- *Primary Side Constant Voltage Regulation:* By monitoring the auxiliary winding voltage, it is possible to regulate accurately the output voltage. The output voltage regulation is typically within $\pm 2\%$.
- *Load Transient Compensation:* Since PFC has low loop bandwidth, abrupt changes in the load may cause excessive over or under-shoot. The slow Over Voltage Protection contains the output voltage when it tends to become excessive. In addition, the NCL30488B speeds up the constant voltage regulation loop when the output voltage goes below 85% of its regulation level.
- *Power Factor Correction:* A proprietary concept allows achieving high power factor correction and low THD while keeping accurate constant current and constant voltage control.
- *Line Feed-forward:* allows compensating the variation of the output current caused by the propagation delay.
- *V_{CC} Over Voltage Protection:* if the V_{CC} pin voltage exceeds an internal limit, the controller shuts down and waits 4 seconds before restarting pulsing.
- *Fast Over Voltage Protection:* If the voltage of ZCD pin exceeds 130% of its regulation level, the controller shuts down and waits 4 s before trying to restart.
- *Brown-Out:* the controller includes a brown-out circuit which safely stops the controller in case the input voltage is too low. The device will automatically restart if the line recovers.

- *Cycle-by-cycle peak current limit:* when the current sense voltage exceeds the internal threshold V_{ILIM}, the MOSFET is turned off for the rest of the switching cycle.
- *Winding Short-Circuit Protection:* an additional comparator senses the CS signal and stops the controller if V_{CS} reaches 1.5 x V_{ILIM} (after a reduced LEB of t_{BCS}). This additional comparator is enabled only during the main LEB duration t_{LEB}, for noise immunity reason.
- *Output Under Voltage Protection:* If a too low voltage is applied on ZCD pin for 90 ms time interval, the controllers assume that the output or the ZCD pin is shorted to ground and shutdown. After waiting 4 seconds, the IC restarts switching.
- *Thermal Shutdown:* an internal circuitry disables the gate drive when the junction temperature exceeds 150°C (typically). The circuit resumes operation once the temperature drops below approximately 140°C.
- *Standby Mode:* In order to decrease the power consumption of the SMPS if no load conditions, the controller features a standby mode, where its own consumption is decreased.

POWER FACTOR AND CONSTANT CURRENT CONTROL

The NCL30488B embeds an analog/digital block to control the power factor and regulate the output current by monitoring the ZCD, CS and HV pin voltages (signals V_{ZCD}, V_{HV_DIV}, V_{CS}). This circuit generates the current setpoint signal and compares it to the current sense signal to turn the MOSFET off. The HV pin provides the sinusoidal reference necessary for shaping the input current. The obtained current reference is further modulated so that when averaged over a half line period, it is equal to the output current reference (V_{REFX}). The modulation and averaging process is made internally by a digital circuit. If the HV pin properly conveys the sinusoidal shape, power factor will be close to 1. Also, the Total Harmonic Distortion (THD) will be low especially if the output voltage ripple is small.

$$I_{OUT} = \frac{V_{REF}}{2N_{sp}R_{sense}} \tag{eq. 1}$$

Where:

- N_{sp} is the secondary to primary transformer turns ratio:
N_{sp} = N_S / N_P
- R_{sense} is the current sense resistor
- V_{REFX} is the output current reference: V_{REFX} = V_{REF} if no dimming

The output current reference (V_{REFX}) is V_{REF} unless the controller operates in constant voltage mode.

PRIMARY SIDE CONSTANT VOLTAGE CONTROL

The auxiliary winding voltage is sampled internally through the ZCD pin.

A precise internal voltage reference $V_{REF(CV)}$ sets the voltage target for the CV loop.

The sampled voltage is applied to the negative input of the constant voltage (CV) operational transconductance amplifier (OTA) and compared to $V_{REF(CV)}$.

A type 2 compensator is needed at the CV OTA output to stabilize the loop. The COMP pin voltage modify the the output current internal reference in order to regulate the output voltage.

When $V_{COMP} \geq 4\text{ V}$, $V_{REFX} = V_{REF}$.

When $V_{COMP} < 0.9\text{ V}$, $V_{REFX} = 0\text{ V}$.

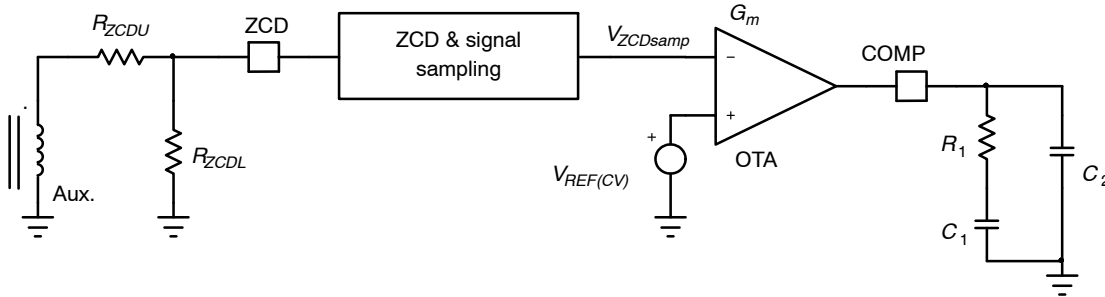

Figure 53. Constant Voltage Feedback Circuit

Secondary Side Regulation Compatible

The NCL30488B is able to support secondary-side regulation as well. The controller features an option to provide a pullup resistor R_{pullup} on COMP pin instead of the CV OTA output. This allows connecting directly an optocoupler collector and properly biases it. The internal voltage biasing R_{pullup} is around 5 V.

In secondary side regulation, the slow and fast OVP on ZCD pin are still active thus providing an additional over voltage protection. In this case, the ZCD pin resistors should be calculated to trigger V_{OVP2} at the output voltage of interest.

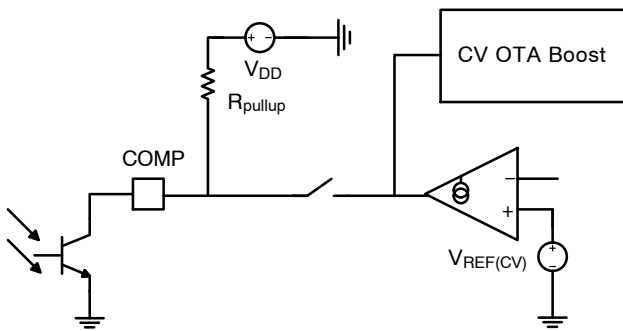

Figure 54. COMP Pin Configuration for Secondary Side Regulation

STARTUP PHASE (HV STARTUP)

It is generally requested that the LED driver starts to emit light in less than 1 s and possibly within 300 ms. It is challenging since the start-up consists of the time to charge the V_{CC} capacitor and that necessary to charge the output capacitor until sufficient current flows into the LED string. This second phase can be particularly long in dimming cases where the secondary current is a portion of the nominal one.

The NCL30488B features a high voltage startup circuit that allows charging V_{CC} pin capacitor very fast.

When the power supply is first connected to the mains outlet, the internal current source is biased and charges up the V_{CC} capacitor. When the voltage on this V_{CC} capacitor reaches the $V_{CC(on)}$ level, the current source turns off. At this time, the controller is only supplied by the V_{CC} capacitor, and the auxiliary supply should take over before V_{CC} collapses below $V_{CC(off)}$.

The HV startup circuitry is made of two startup current levels, $I_{HV(start1)}$ and $I_{HV(start2)}$. This helps to protect the controller against short-circuit between V_{CC} and GND. At power-up, as long as V_{CC} is below $V_{CC(TH)}$, the source delivers $I_{HV(start1)}$ (around 300 μA typical). Then, when V_{CC} reaches $V_{CC(TH)}$, the source smoothly transitions to $I_{HV(start2)}$ and delivers its nominal value. As a result, in case of short-circuit between V_{CC} and GND occurring at high line ($V_{in} = 305\text{ V rms}$), the maximum power dissipation will be $431 \times 300 \mu = 130\text{ mW}$ instead of 1.5 W if there was only one startup current level.

To speed-up the output voltage rise, the following is implemented:

- The digital OTA output is increased until $V_{REF(PFC)}$ signal reaches V_{REFX} . Again, this is to speed-up the control signal rise to their steady state value.
- At the beginning of each operating phase of a V_{CC} cycle, the digital OTA output is set to 0. Actually, the digital OTA output is set to 0 in the case of a cold start-up or in the case of a start-up sequence following an operation interruption due to a fault. On the other hand, if the V_{CC} hiccups just because the system fails to start-up in one V_{CC} cycle, the digital OTA output is not reset to ease the second (or more) attempt. But, the digital OTA stops integrating if $V_{CC} < V_{CC(off)}$. The compensator output then restarts from its setpoint before the UVLO, thus avoiding any output current overshoot if a resistor is inserted in series with HV pin.

- If the load is shorted, the circuit will operate in hiccup mode with V_{CC} oscillating between $V_{CC(off)}$ and $V_{CC(on)}$ until the output under voltage protection (UVP) trips. UVP is triggered if the ZCD pin voltage does not exceed $V_{ZCD(short)}$ within a 90 ms operation of time. This indicates that the ZCD pin is shorted to ground or that an excessive load prevents the output voltage from rising.

HV Startup Power Dissipation

At high line (305 V rms and above) the power dissipated by the HV startup in case of fault becomes high. Indeed, in case of fault, the NCL30488B is directly supplied by the HV rail. The current flowing through the HV startup will heat the controller. It is highly recommended adding enough copper around the controller to decrease the $R_{\theta JA}$ of the controller.

Adding a minimum pad area of 215 mm² of 35 μm copper (1 oz) drops the $R_{\theta JA}$ to around 120°C/W (no air flow, $R_{\theta JA}$ measured at ADIM pin)

The PCB layout shown in Figure 55 is a layout example to achieve low $R_{\theta JA}$.

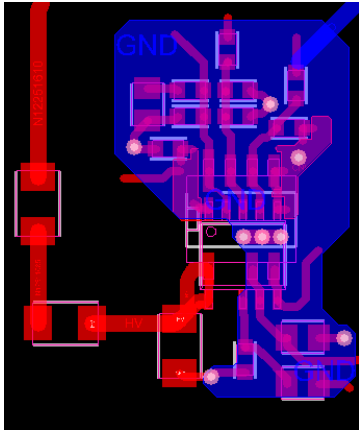

Figure 55. PCD Layout Example

The application note [AND90120](#) gives more details about strategies to decrease the power dissipation of the HV startup circuit.

Cycle-by-Cycle Current Limit

When the current sense voltage exceeds the internal threshold V_{ILIM} , the MOSFET is turned off for the rest of the switching cycle.

Winding and Output Diode Short-Circuit Protection

In parallel to the cycle-by-cycle sensing of the CS pin, another comparator with a reduced LEB (t_{BCS}) and a threshold of ($V_{CS(stop)} = 140\% \times V_{ILIM}$) monitors the CS pin to detect a winding or an output diode short circuit. The controller shuts down if it detects 4 consecutive pulses during which the CS pin voltage exceeds $V_{CS(stop)}$.

The controller goes into auto-recovery mode.

Valley Lockout

Quasi-Square wave resonant systems have a wide switching frequency excursion. The switching frequency increases when the output load decreases or when the input voltage increases. The switching frequency of such systems must be limited.

The NCL30488B changes valley as V_{REFX} decreases and as the input voltage increases and as the output current setpoint is varied during dimming. This limits the frequency excursion.

By default, when the output current is not dimmed, the controller operates in the first valley at low line and in the second valley at high line.

(prog. option to have the operating valley incremented by 1 at high line for better I_{out} control at 305 V rms.)

Table 1. VALLEY SELECTION

V_{REFX} value at which the Controller Changes Valley (I_{out} Decreasing)	V_{HV_DIV} Voltage for Valley Change		V_{REFX} Value at Which the Controller Changes Valley (I_{out} Increasing)
	0 --LL-- 2.3 V	--HL-- 5 V	
I_{out} decreases 	100%	1 st	100%
	80%	2 nd	90%
	65%	3 rd	75%
	50%	4 th	60%
	35%	5 th	45%
	25%	6 th	35%
	0%	FF mode	0%
	Internal V_{HV_DIV} Voltage for Valley Change		

Zero Crossing Detection Block

The ZCD pin allows detecting when the drain–source voltage of the power MOSFET reaches a valley.

A valley is detected when the ZCD pin voltage crosses below the 55 mV internal threshold.

At startup or in case of extremely damped free oscillations, the ZCD comparator may not be able to detect

the valleys. To avoid such a situation, NCL30488B features a Time–Out circuit that generates pulses if the voltage on ZCD pin stays below the 55 mV threshold for 6.5 μ s.

The Time–out also acts as a substitute clock for the valley detection and simulates a missing valley in case of too damped free oscillations.

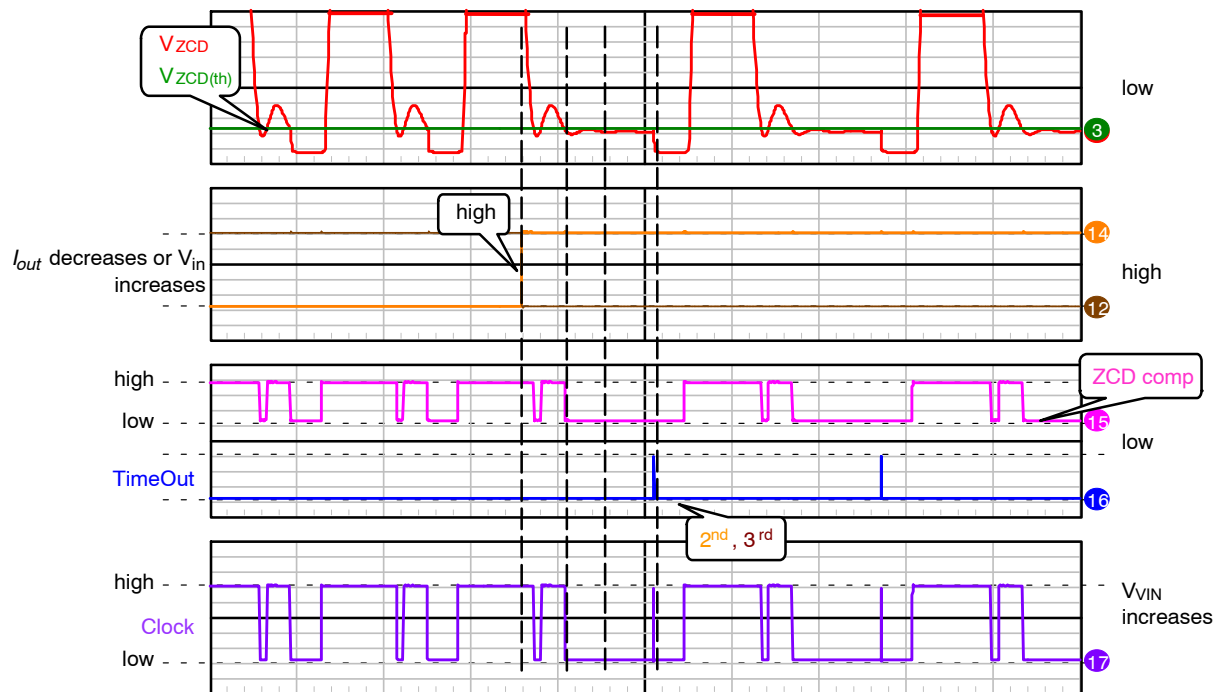

Figure 56. Valley Detection and Time–out Chronograms

If the ZCD pin or the auxiliary winding happen to be shorted the time–out function would normally make the controller keep switching and hence lead to improper regulation of the LED current.

The Under Voltage Protection (UVP) is implemented to avoid these scenarios: a secondary timer starts counting when the ZCD voltage is below the $V_{ZCD(short)}$ threshold. If this timer reaches 90 ms, the controller detects a fault and enters the auto–recovery fault mode.

Minimum Off–time at Startup

At startup, the output voltage reflected on the auxiliary winding is low. Thus, the voltage on the ZCD pin is very low and the ZCD comparator might be unable to detect the valleys. In this condition, setting the DRV latch with the 6.5– μ s time–out leads to a continuous conduction mode operation (CCM).

To avoid CCM pulses during startup, a minimum off time (typ. 50 μ s) is forced when $V_{ZCD} < V_{ZCD(short)}$ during 8 ms.

This minimum off time is also present when the controller restart after a fault, if $V_{ZCD} < V_{ZCD(short)}$.

ZCD Over Voltage Protection

Because of the power factor correction, it is necessary to set the crossover frequency of the CV loop very low (target

10 Hz, depending on power stage phase shift). Because the loop is slow, the output voltage can reach high value during startup or during an output load step. It is necessary to limit the output voltage excursion. For this, the NCL30488B features a slow OVP and a fast OVP on ZCD pin.

Slow OVP

If ZCD voltage exceeds V_{OVP1} for 4 consecutive switching cycles, the controller stops switching during 1.4 ms. The PFC loop is not reset. After 1.4 ms, the controller initiates a new DRV pulse to refresh ZCD sampling voltage. If V_{ZCD} is still too high ($V_{ZCD} > 115\% V_{REF(CV)}$), the controller continues to switch with a 1.4 ms period. The controller resumes its normal operation when $V_{ZCD} < 105\% V_{REF(CV)}$.

During slow OVP, the peak current setpoint is COMP pin voltage scaled down by a fixed ratio.

Fast OVP

If ZCD voltage exceeds V_{OVP2} (130% of $V_{REF(CV)}$) for 4 consecutive switching cycles (slow OVP not triggered) or for 2 switching cycles if the slow OVP has already been triggered, the controller detects a fault and starts the auto–recovery fault mode (cf: Fault Management Section)

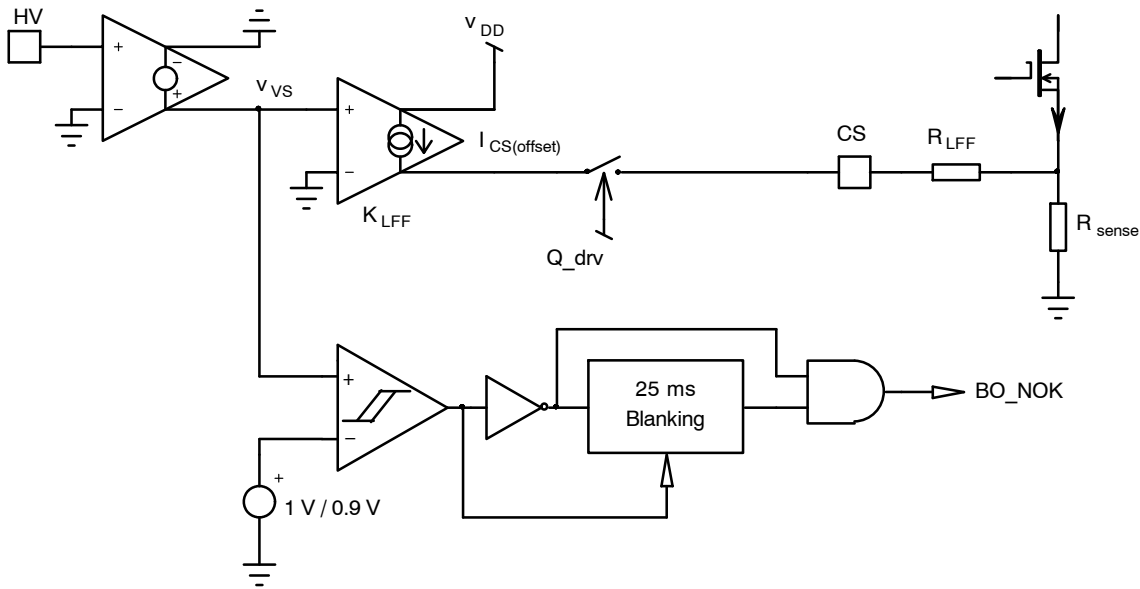

Figure 57. Line Feed-Forward and Brown-out Schematic

Line Feedforward

The line voltage is sensed by the HV pin and converted into a current. By adding an external resistor in series between the sense resistor and the CS pin, a voltage offset proportional to the line voltage is added to the CS signal. The offset is applied only during the MOSFET on-time in order to not influence the detection of the leakage inductance reset.

The offset is always applied even at light load in order to improve the current regulation at low output load.

Brown-out

In order to protect the supply against a very low input voltage, the controller features a brown-out circuit with a fixed ON/OFF threshold. The controller is allowed to start

if a voltage higher than $V_{HVBO(on)}$ is applied to the HV pin and shuts-down if the HV pin voltage decreases and stays below $V_{HVBO(off)}$ for 25 ms typical.

An option with higher brown-out levels is also available (see ordering table and electricals parameters)

Line OVP

In order to protect the power supply in case of too high input voltage, the NCL30488B features a line over voltage protection. When the voltage on HV pin exceeds $V_{HV(OVP)}$ the controller stops switching; V_{CC} hiccups.

When V_{HV} becomes lower than $V_{HV(OVP)RST}$ for more than 340 ms, the controller initiates a clean startup sequence and re-starts switching.

NCL30488B

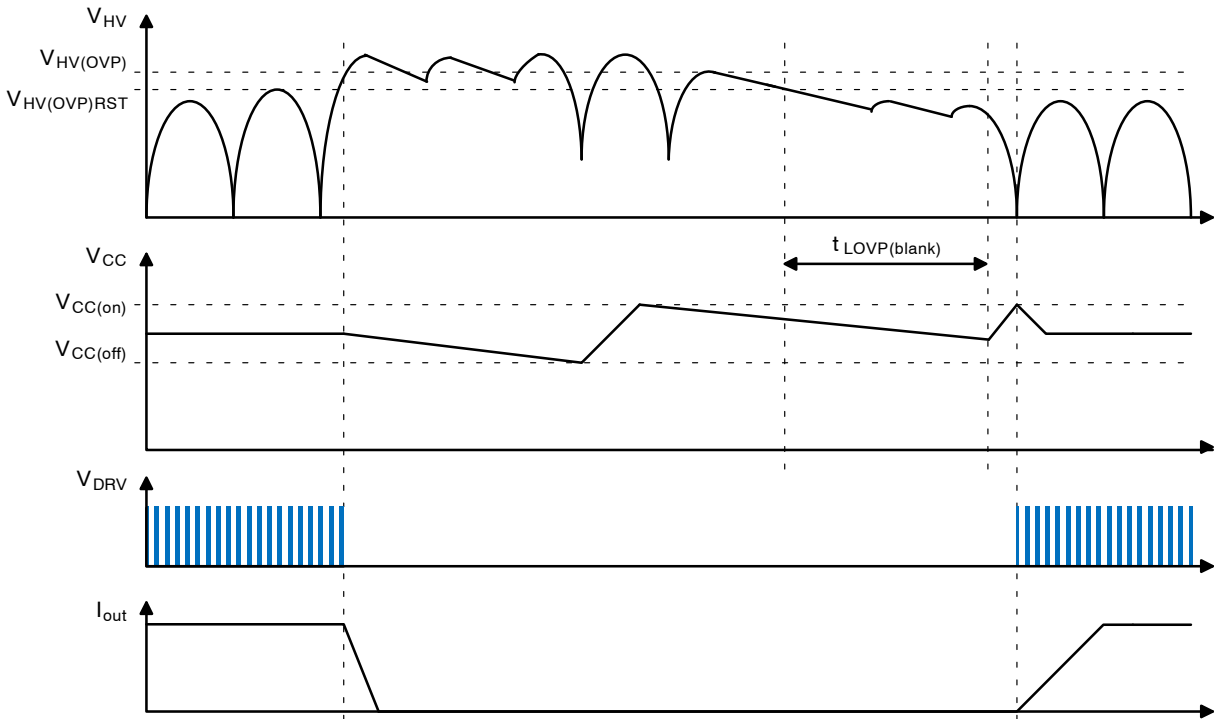

Figure 58. Line OVP Chronograms

Standby Mode

In order to decrease the power drawn from the mains in no load conditions, the NCL30488B implements a standby mode. In this mode, the current consumption of the controller is reduced to I_{CC4} .

In standby mode, the peak current is frozen to a fixed value $V_{CS(STBY)}$ (25% or below of V_{LIMIT}) and the controller adjust the switching frequency, more specifically the

dead-time (DT) to keep the output voltage regulated (pink curve in Figure 59).

The regulation of V_{out} is based on COMP pin voltage varying between 700 mV to 913 mV.

Standby mode is entered if $V_{COMP} < 895$ mV, V_{COMP} decreasing and exit if $V_{COMP} > 913$ mV, V_{COMP} increasing. (See [AND90120](#) for more details concerning the standby mode)

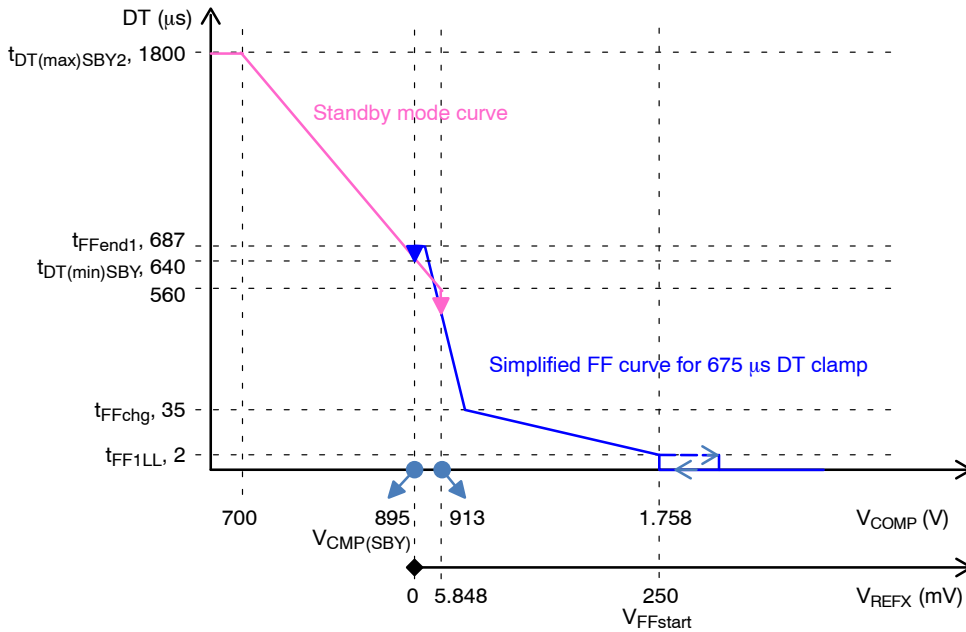

Figure 59. Dead-time Setpoint as a Function of V_{COMP}

NCL30488B

Standby mode is entered if $V_{COMP} < 895 \text{ mV}$, V_{COMP} decreasing and exit if $V_{COMP} > 913 \text{ mV}$, V_{COMP} increasing.

Variable Maximum On-time

Around line zero-crossing, the primary inductor slope is too low to reach the peak current setpoint imposed by the CC control. The DRV pulse is terminated by the max. on-time.

This creates sudden variation of the on-time and creates an input current spike (EMI filter inductance responds to rate of change of current).

Varying the maximum on-time with V_{REFX} helps decreasing this spike over the output load range. Figure 60 and Figure 61 shows the maximum on-time curve as a function of V_{REFX} .

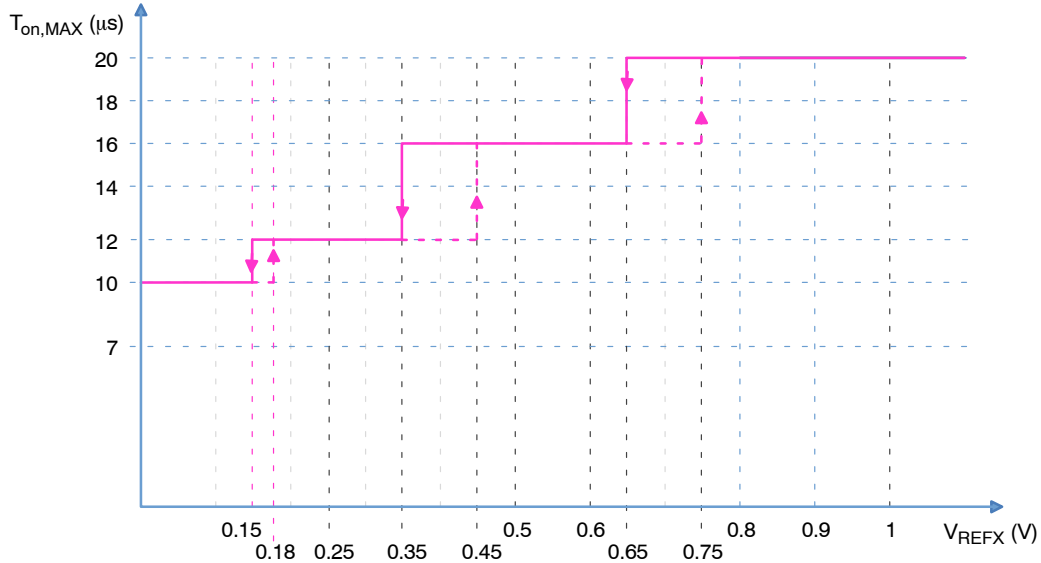

Figure 60. Variable Maximum On-time, 20- μs Option

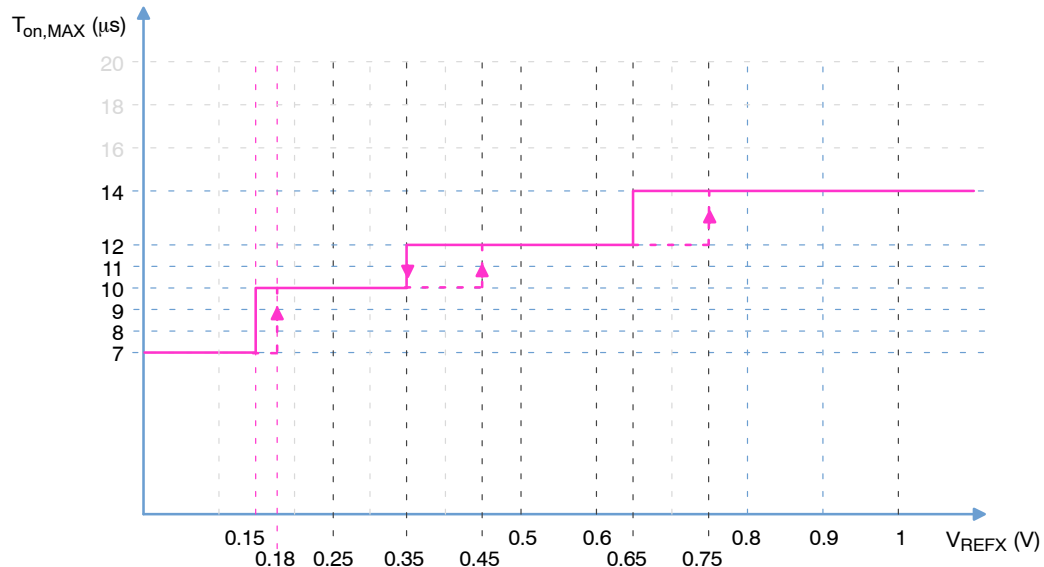

Figure 61. Variable Maximum On-time, 14- μs Option

Protections

The circuit incorporates a large variety of protections to make the LED driver very rugged.

Among them, we can list:

- **Fault of the GND connection**
If the GND pin is properly connected, the supply current drawn from the positive terminal of the V_{CC} capacitor, flows out of the GND pin to return to the negative terminal of the V_{CC} capacitor. If the GND pin is not connected, the circuit ESD diodes offer another return path. The accidental non connection of the GND pin can hence be detected by detecting that one of this ESD diode is conducting. Practically, the ESD diode of CS pin is monitored. If such a fault is detected for 200 μ s, the circuit stops generating DRV pin.
- **Output short circuit situation (Output Under Voltage Protection)**
Overload is detected by monitoring the ZCD pin voltage: if it remains below $V_{ZCD(short)}$ for 90 ms, an output short circuit is detected and the circuit stops generating pulses for 4 s. When this 4 s delay has elapsed, the circuit attempts to restart.
- **ZCD pin incorrect connection:**
 - ◆ If the ZCD pin grounded, the circuit will detect an output short circuit situation when 90 ms delay has elapsed.
 - ◆ A 200 k Ω resistor pulls down the ZCD pin so that the output short circuit detection trips if the ZCD pin is not connected (floating).
- **Winding or Output Diode Short Circuit protection**
The circuit detects this failure when 4 consecutive DRV pulses occur within which the CS pin voltage exceeds ($V_{CS(stop)} = 140\% \times V_{ILIM}$). In this case, the controller enters auto-recovery mode (4-s operation interruption between active bursts).
- **V_{CC} Over Voltage Protection**
The circuit stops generating pulses if the V_{CC} exceeds $V_{CC(OVP)}$ and enters auto-recovery mode. This feature protects the circuit if output LEDs happen to be disconnected.
- **ZCD fast OVP**
If ZCD voltage exceeds $V_{ZCD(OVP2)}$ for 4 consecutive switching cycles (slow OVP not triggered) or for 2 switching cycles if the slow OVP has already been triggered, the controller detects a fault and enters auto-recovery mode (4 s operation interruption between active bursts).
- **Die Over Temperature (TSD)**
The circuit stops operating if the junction temperature (T_J) exceeds 150°C typically. The controller remains off until T_J goes below nearly 130°C.
- **Brown-Out Protection (BO)**
The circuit prevents operation when the line voltage is too low to avoid an excessive stress of the LED driver. Operation resumes as soon as the line voltage is high enough and V_{CC} is higher than $V_{CC(on)}$.
- **CS pin short to ground**
The CS pin is checked at start-up (cold start-up or after a brown-out event). A current source ($I_{CS(short)}$) is applied to the pin and no DRV pulse is generated until the CS pin exceeds $V_{CS(low)}$. $I_{CS(short)}$ and $V_{CS(low)}$ are 500 μ A and 60 mV typically (V_{CS} rising). The typical minimum impedance to be placed on the CS pin for operation is then 120 Ω . In practice, it is recommended to place more than 250 Ω to take into account possible parametric deviations. Also, along the circuit operation, the CS pin could happen to be grounded. If it is grounded, the MOSFET conduction time is limited by the 20 μ s maximum on-time. If such an event occurs, a new pin impedance test is made.
- **Line overvoltage protection**
(see [Line OVP](#) section)

NCL30488B

ORDERING TABLE OPTION

OPN # NCL30488__	Dead-time Clamp			V _{REF}		Max. On-time		ZCD Blanking		Valley Transition from LL to HL		Standby Mode		Line Range Detector	
	250 μ s	687 μ s	1.4 ms	200 mV	333 mV	14 μ s	20 μ s	1 μ s	1.5 μ s	1 st to 2 nd	1 st to 3 rd	On	Off	On	Off
NCL30488B1		x			x		x	x		x		x		x	
NCL30488B2		x			x		x	x		x		x		x	
NCL30488B4		x			x		x	x		x		x		x	

OPN # NCL30488__	Line OVP		Frozen Peak Current During Standby Mode V _{CS(SBY)}			Brown-out Levels		COMP Pin R _{pullup} (CV OTA output disconnected)	
	On	Off	380 mV	330 mV	280 mV	On: 108 V Off: 98 V	On: 138 V Off: 129 V	On	Off
NCL30488B1	x		x			x			x
NCL30488B2	x		x				x		x
NCL30488B4	x		x			x		x	

ORDERING INFORMATION

Device	Marking	Package Type	Shipping [†]
NCL30488B1	L30486B2	SOIC7 – P7 COMP VHV PBFH (Pb-Free)	2500 / Tape & Reel
NCL30488B2	L30488B3	SOIC7 – P7 COMP VHV PBFH (Pb-Free)	2500 / Tape & Reel
NCL30488B4	L30488B4	SOIC7 – P7 COMP VHV PBFH (Pb-Free)	2500 / Tape & Reel

[†]For information on tape and reel specifications, including part orientation and tape sizes, please refer to our Tape and Reel Packaging Specifications Brochure, BRD8011/D.

NCL30488B

PACKAGE DIMENSIONS

SOIC-7
CASE 751U-01
ISSUE E

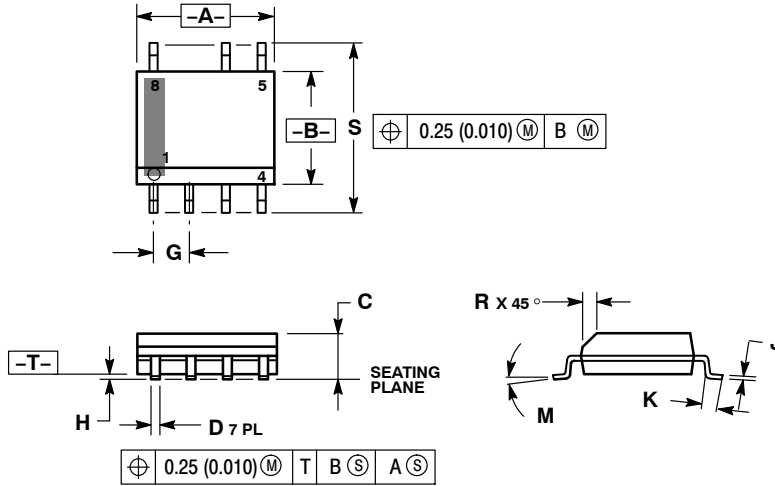

NOTES:

1. DIMENSIONING AND TOLERANCING PER ANSI Y14.5M, 1982.
2. CONTROLLING DIMENSION: MILLIMETER.
3. DIMENSION A AND B ARE DATUMS AND T IS A DATUM SURFACE.
4. DIMENSION A AND B DO NOT INCLUDE MOLD PROTRUSION.
5. MAXIMUM MOLD PROTRUSION 0.15 (0.006) PER SIDE.

DIM	MILLIMETERS		INCHES	
	MIN	MAX	MIN	MAX
A	4.80	5.00	0.189	0.197
B	3.80	4.00	0.150	0.157
C	1.35	1.75	0.053	0.069
D	0.33	0.51	0.013	0.020
G	1.27 BSC		0.050 BSC	
H	0.10	0.25	0.004	0.010
J	0.19	0.25	0.007	0.010
K	0.40	1.27	0.016	0.050
M	0°	8°	0°	8°
N	0.25	0.50	0.010	0.020
S	5.80	6.20	0.228	0.244

SOLDERING FOOTPRINT*

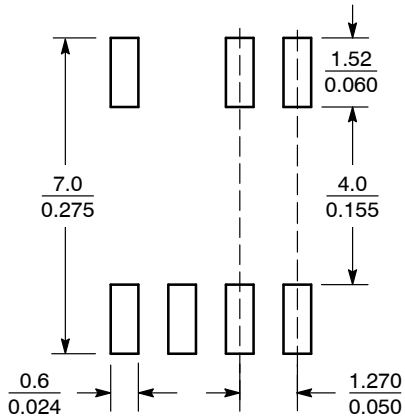

SCALE 6:1 ($\frac{\text{mm}}{\text{inches}}$)

*For additional information on our Pb-Free strategy and soldering details, please download the ON Semiconductor Soldering and Mounting Techniques Reference Manual, SOLDERRM/D.