



# TAOGLAS®



# Datasheet

## NCP.5820

**Part No:**  
NCP.5820

### **Description:**

NB-IoT SMD Ceramic Antenna  
For Bands 5, 8 and 20

### **Features:**

Small size, small footprint SMD antenna  
Global NB-IoT Coverage for:  
Band 5, 824-894MHz  
Band 8, 880-960MHz  
Band 20, 791-862mHz  
High efficiency across each band  
Dimensions: 14.1 x 8.3 x 2mm  
Automotive IATF16949 Production and Quality Approved  
RoHS & Reach Compliant

1. Introduction	3
2. Specifications	4
3. Antenna Characteristics	5
4. Radiation Patterns	9
5. Mechanical Drawing	18
6. Antenna Integration Guide	22
7. Evaluation Board Matching Circuit	25
8. Packaging	27
<hr/>	
Changelog	28

Taoglas makes no warranties based on the accuracy or completeness of the contents of this document and reserves the right to make changes to specifications and product descriptions at any time without notice. Taoglas reserves all rights to this document and the information contained herein.

Reproduction, use or disclosure to third parties without express permission is strictly prohibited.



# 1. Introduction

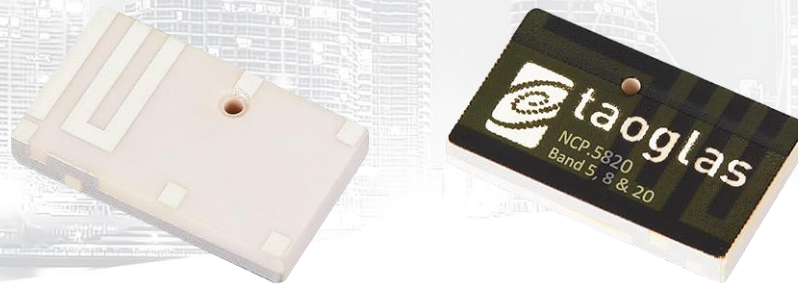

The evolution of IoT connectivity has seen an urgent need for low power applications that can connect thousands of devices to the internet and Narrowband IoT (NB-IoT) is a new way to facilitate this demand. For a small compact embedded antenna, the Taoglas NCP.5820 fits will fit in many size challenged designs without performance compromises.

The Taoglas NCP.5820 supports Bands 5 (824-894MHz), 8 (880-960MHz) and 20 (791-862MHz) providing global NB-IoT coverage and demonstrates excellent efficiency across all bands.

The antenna measures just 14.1x8.3x2mm and as it is a surface mount antenna, it can be easily integrated into the smallest of devices. It allows device designers to take advantage of all of the benefits of NB-IoT technology, including reduced power consumption and increased battery life; increased system capacity and spectrum efficiency; and extended coverage in both rural and deep indoors environments all with a very small form factor. For Testing, the NCP.5820 can be supplied with the evaluation board NCPD.5820 – see section 5.

Overall, this antenna is suitable for applications that need to meet the following requirements:

- Small footprint, low profile design factor
- SMD Components for assembly accuracy and reliability
- Excellent antenna efficiency helping to maintain better system gain, hence better device send and receive sensitivity (TRP & TIS)
- Excellent antenna efficiency to aid lower power consumption and increased battery life
- Global coverage for device roaming
- 100% quality and performance testing prior to shipping for reliability and consistency

For more information or support with integrating this antenna into your device, please contact your regional Taoglas customer support team.

## 2. Specifications

Band 5,8 Electrical			
	Band 5	Band 8	
Frequency (MHz)	824~894	880~960	
Peak Gain (dBi)*	0.6	1.2	
Average Gain (dB)*	-3.5	-2.7	
Efficiency (%) *	53.5	60.7	
Return Loss (dB)*	<-4.5	<-5	

Band 5,8,20 Electrical			
	Band 5	Band 8	Band 20
Frequency (MHz)	824~894	880~960	791~862
Peak Gain (dBi)*	1.1	1.7	-0.3
Average Gain (dB)*	-3.9	-3.1	-4.3
Efficiency (%) *	47	53.1	38.7
Return Loss (dB)*	<-4.5	<-5	<-4.5
Impedance	50 Ω		
Maximum Input Power	5W		

Mechanical	
Antenna Dimensions	14.1mm x 8.3mm x 2mm
Material	Ceramic
Weight	0.76 g
Soldering Type	SMD through Reflow

Environmental	
Operation Temperature	-40°C ~ +85°C
Storage Temperature	-40°C ~ +85°C
Humidity	Non-condensing 65°C 95% RH
Moisture Sensitivity Level (MSL)	3 (168 Hours)

\*Note: All measurements were conducted with SMD on a 115\*35mm evaluation board with 100mm length ground plane and matching circuit. See EVB drawing and matching circuit diagram in Section 5 and Section 7.

### 3. Antenna Characteristics

All data was measured on the evaluation board illustrated in Section 5.4, with the documented matching circuit, section 7

#### 3.1 Band 5 & 8 configuration

##### Return Loss

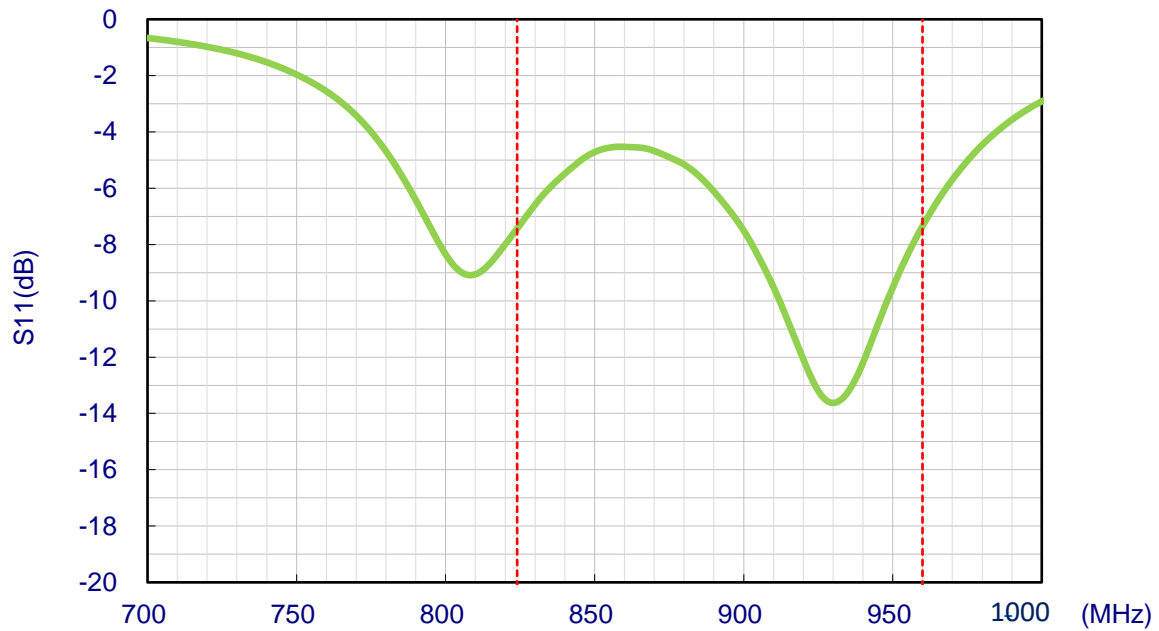

##### Efficiency

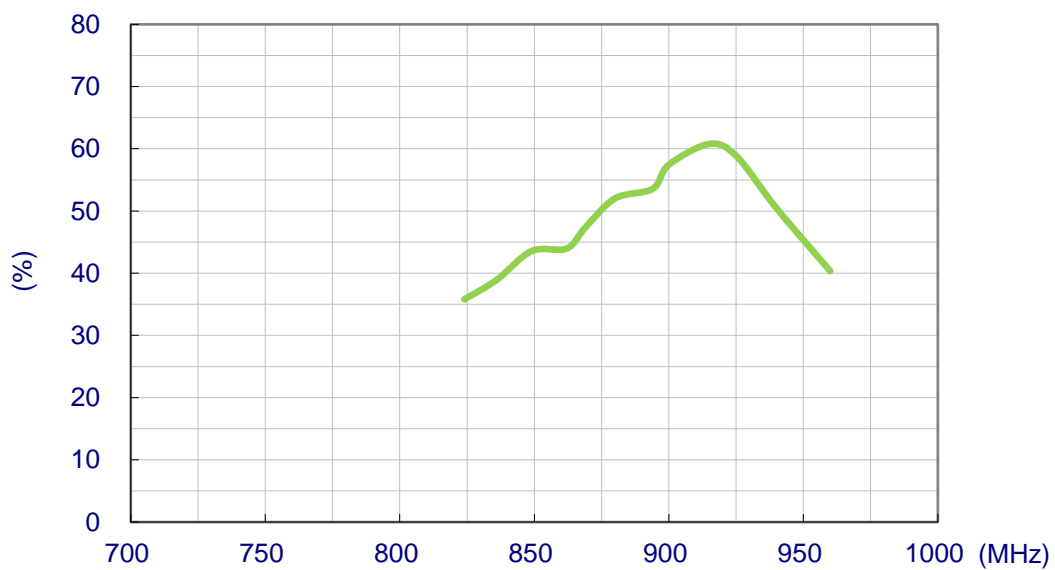

## Average Gain

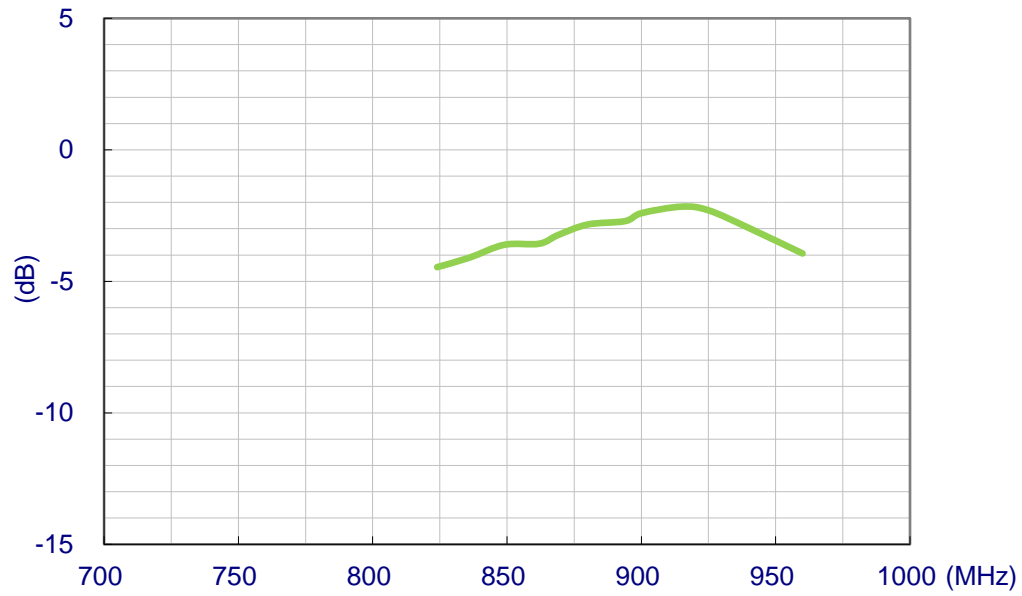

## Peak Gain

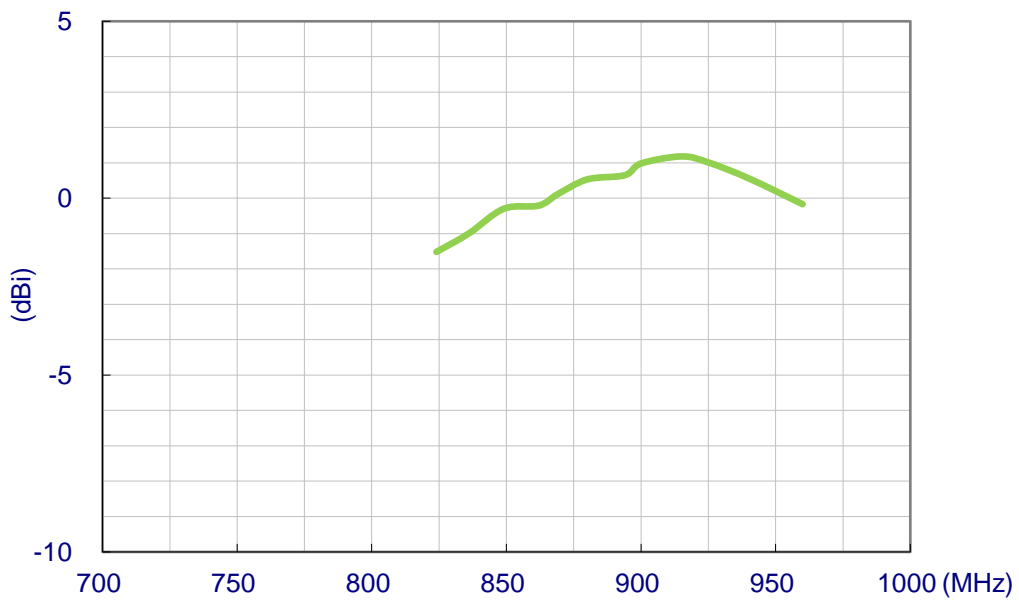

### 3.2 Band 5,8 & 20 configuration

#### Return Loss

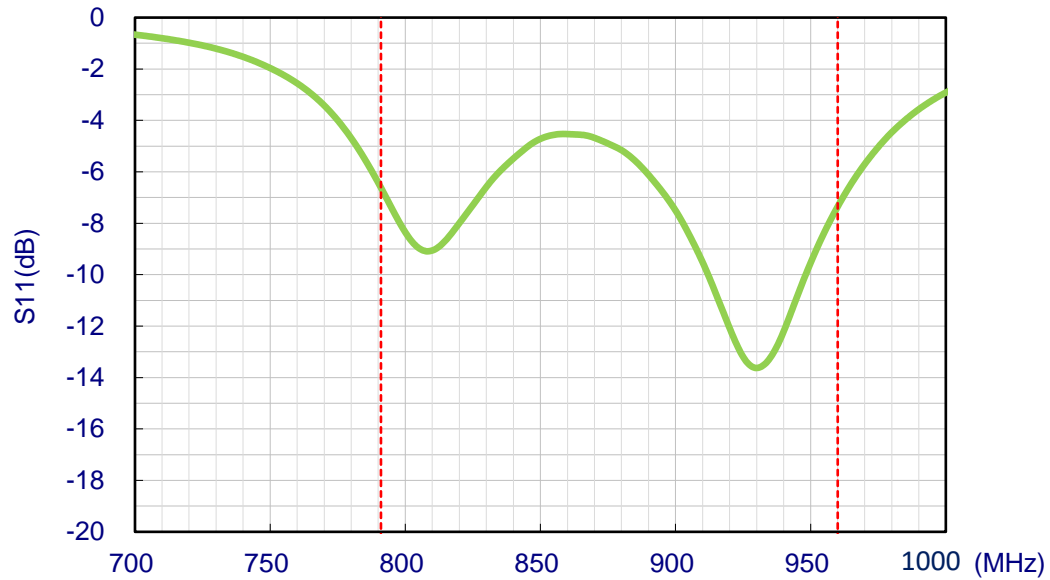

#### Efficiency

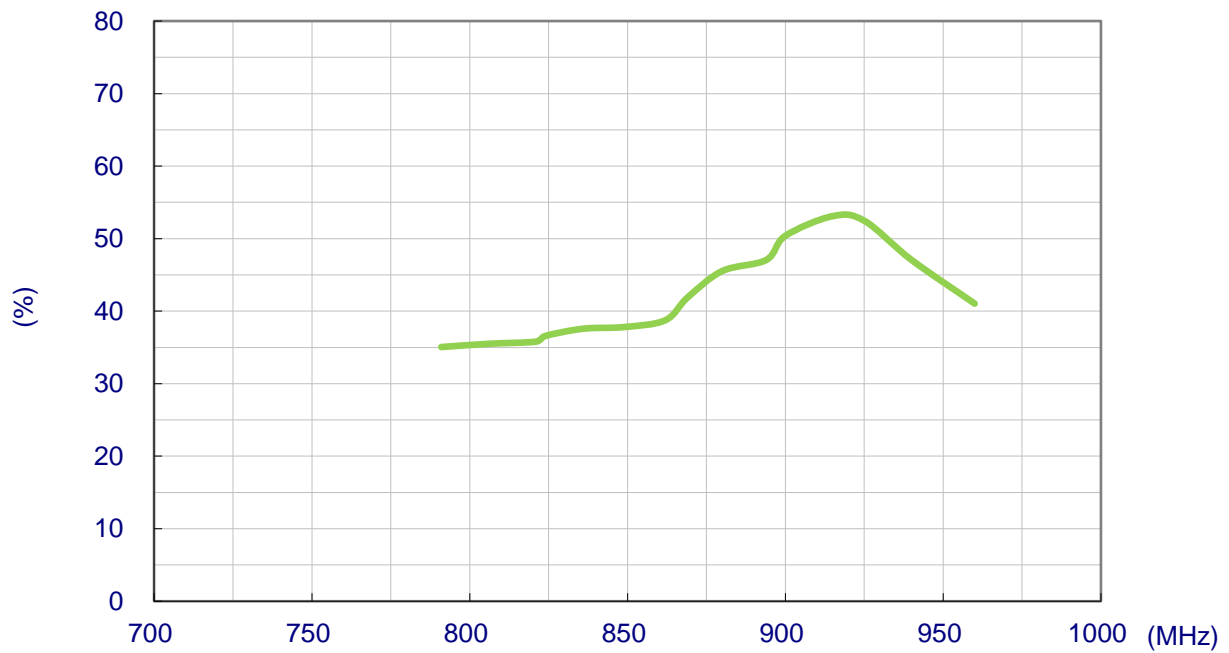

**Average Gain**

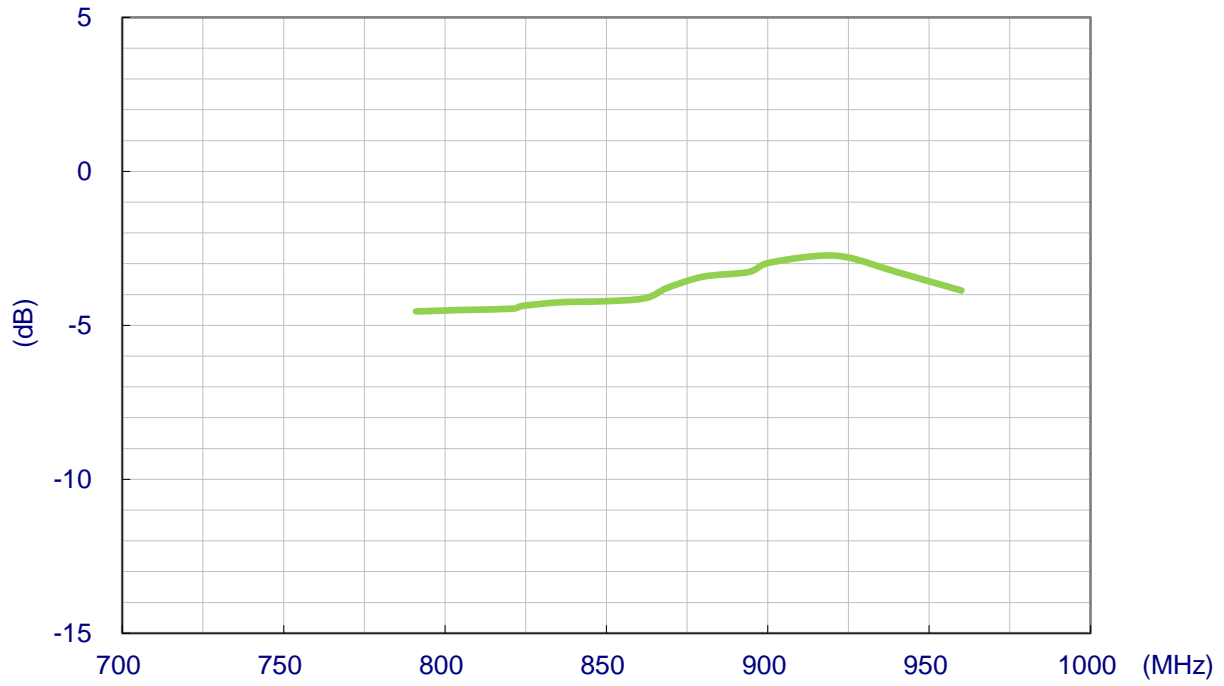

**Peak Gain**

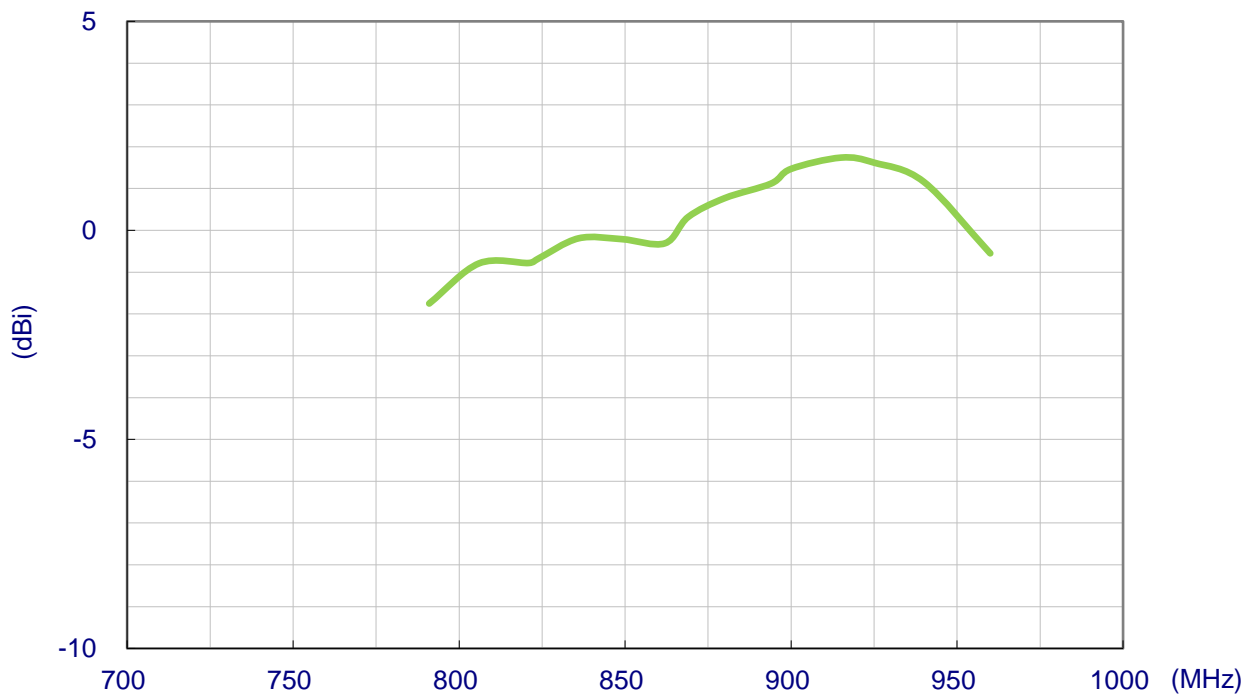



## 4. Radiation Patterns

### 4.1 Test Setup Band 5 & 8 configuration

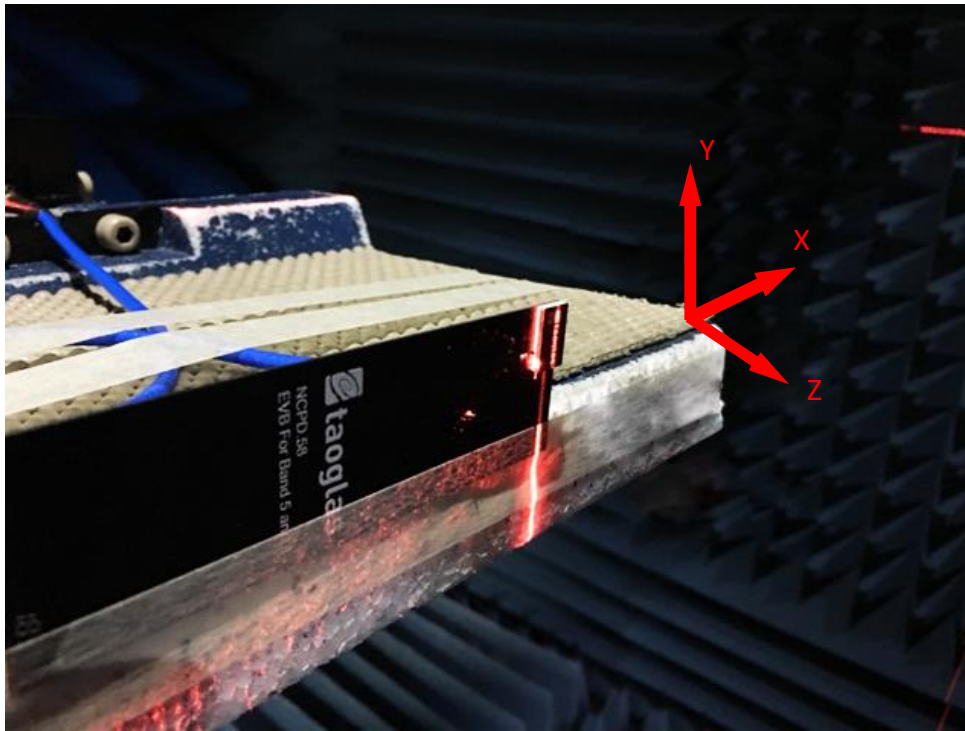

On Evaluation Board (NCPD.5820)

4.2 824 MHz 3D and 2D Radiation Patterns

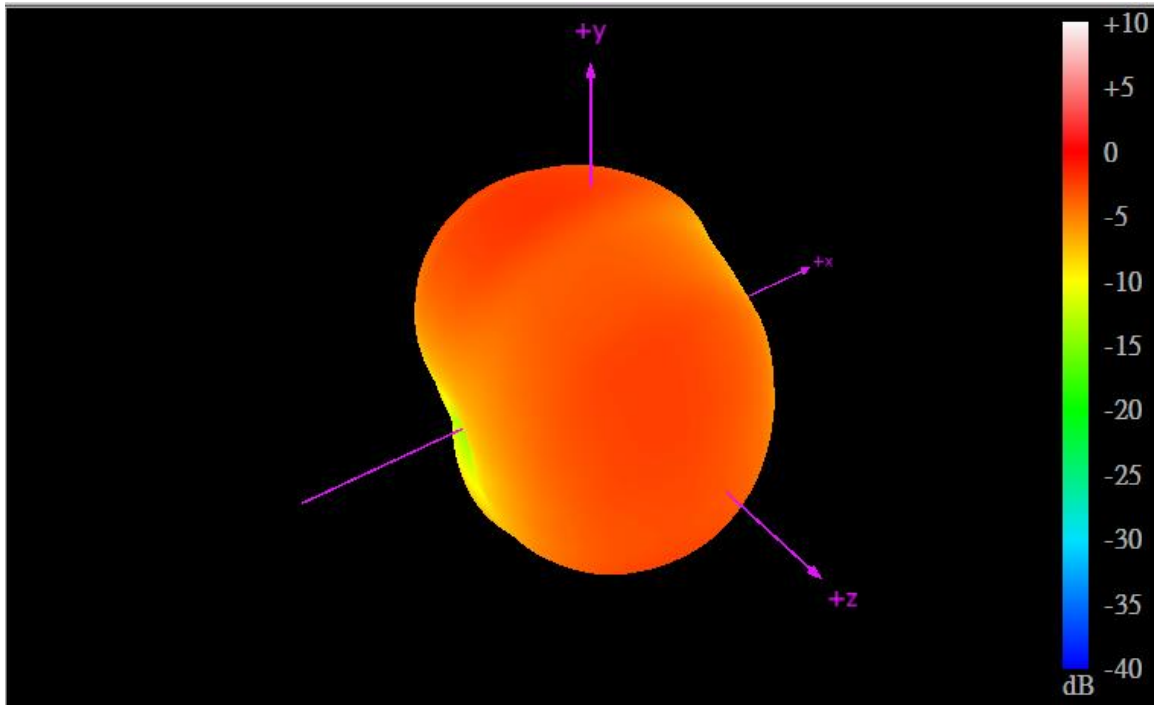

XZ Plane

YZ Plane

XY Plane

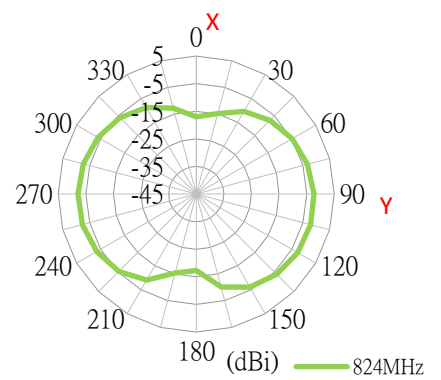
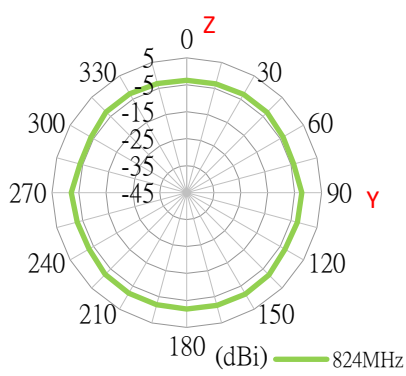
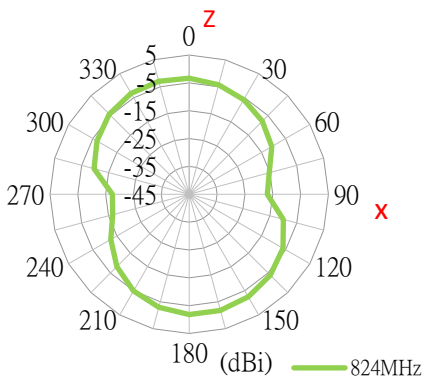

4.3 894 MHz 3D and 2D Radiation Patterns

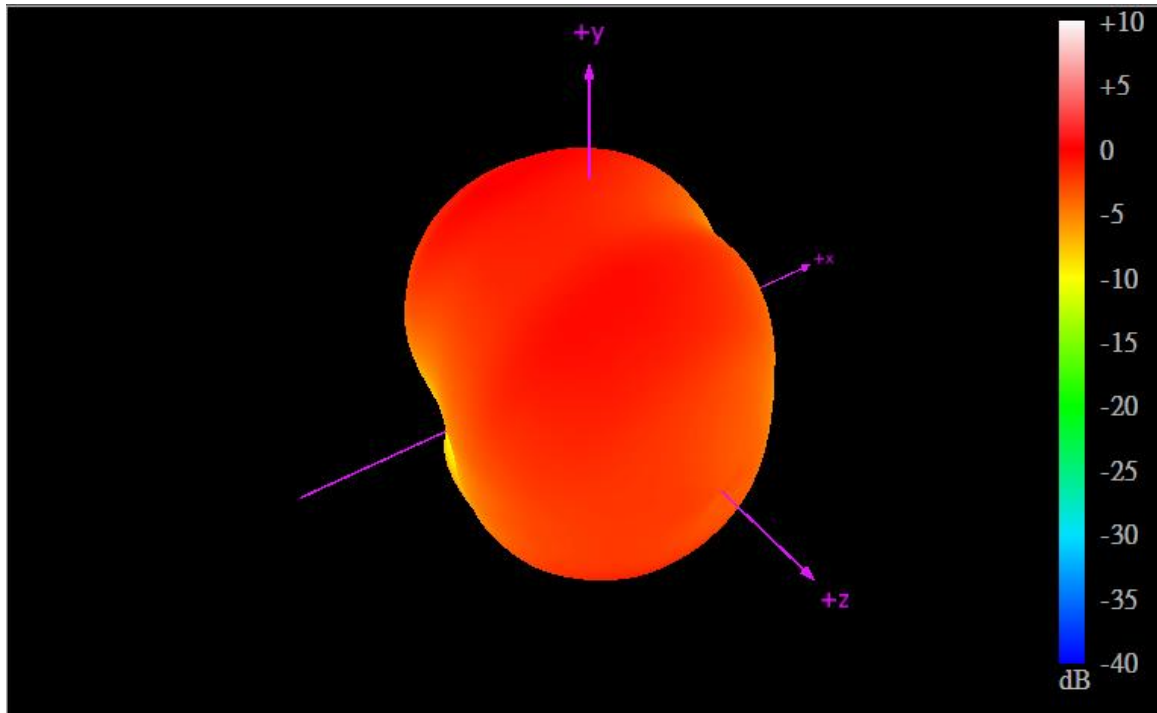

XZ Plane

YZ Plane

XY Plane

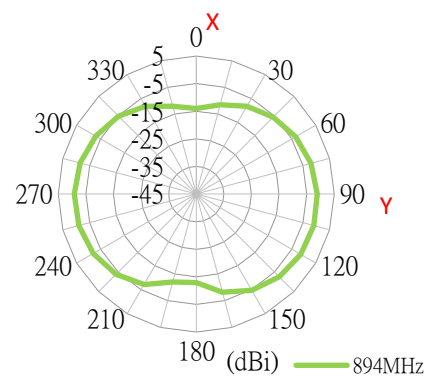
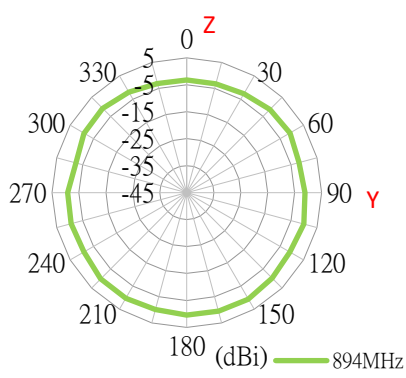
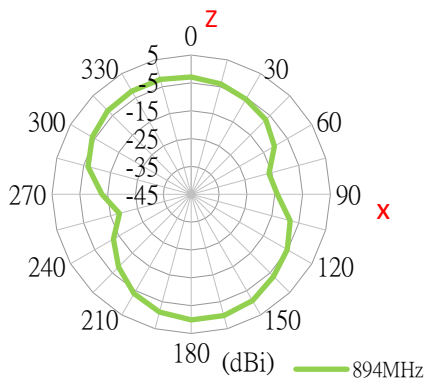

4.4 960 MHz 3D and 2D Radiation Patterns

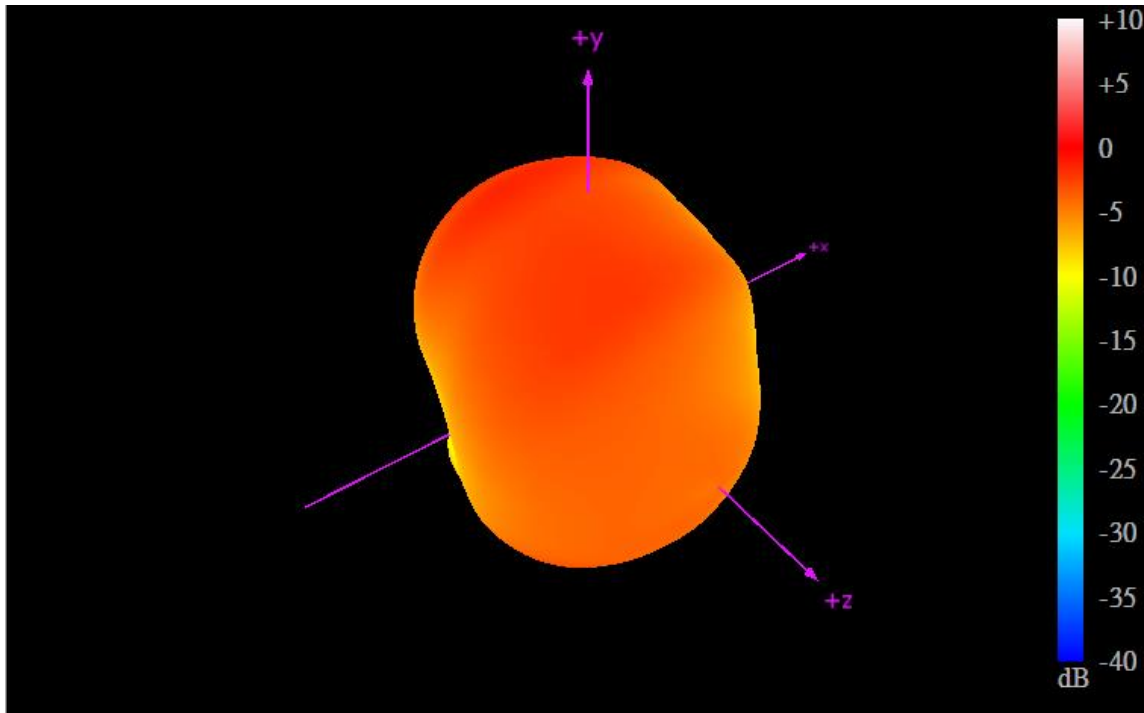

XZ Plane      YZ Plane      XY Plane

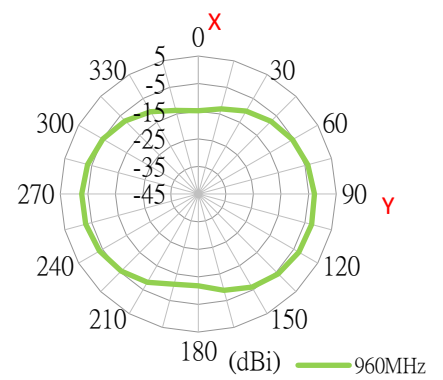
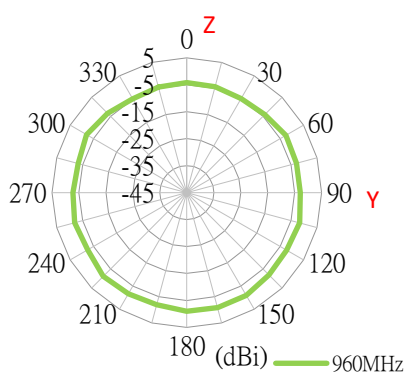
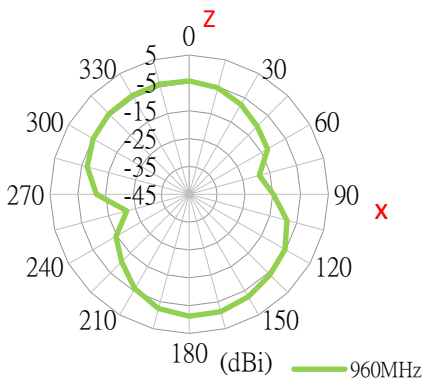

4.5 Test Setup Band 5,8 & 20 configuration

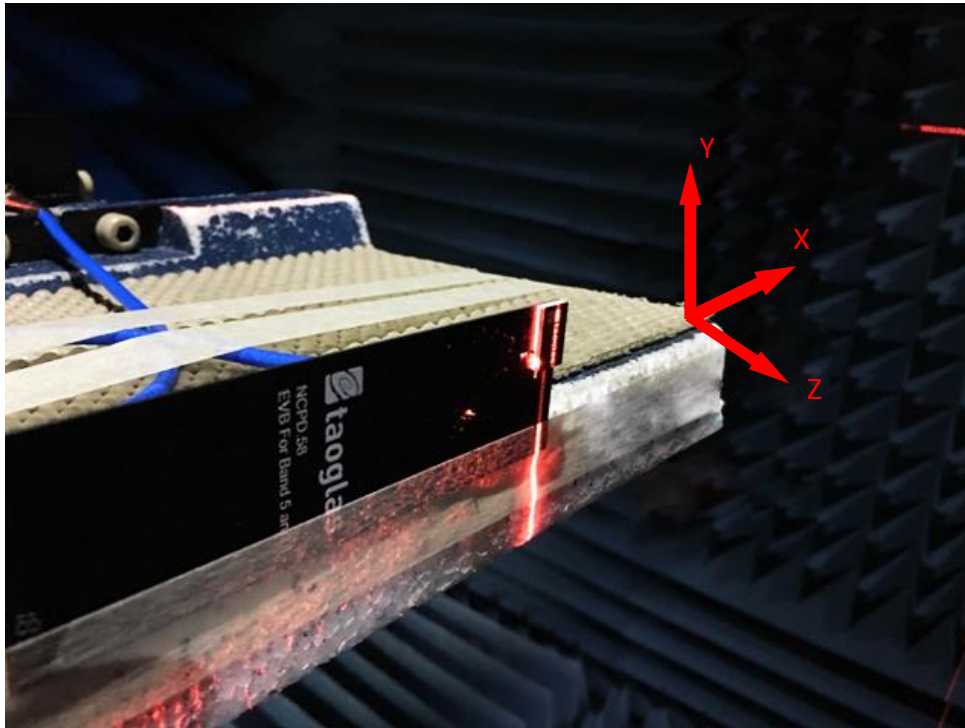

On Evaluation Board (NCPD.5820)

4.6 791MHz 3D and 2D Radiation Patterns

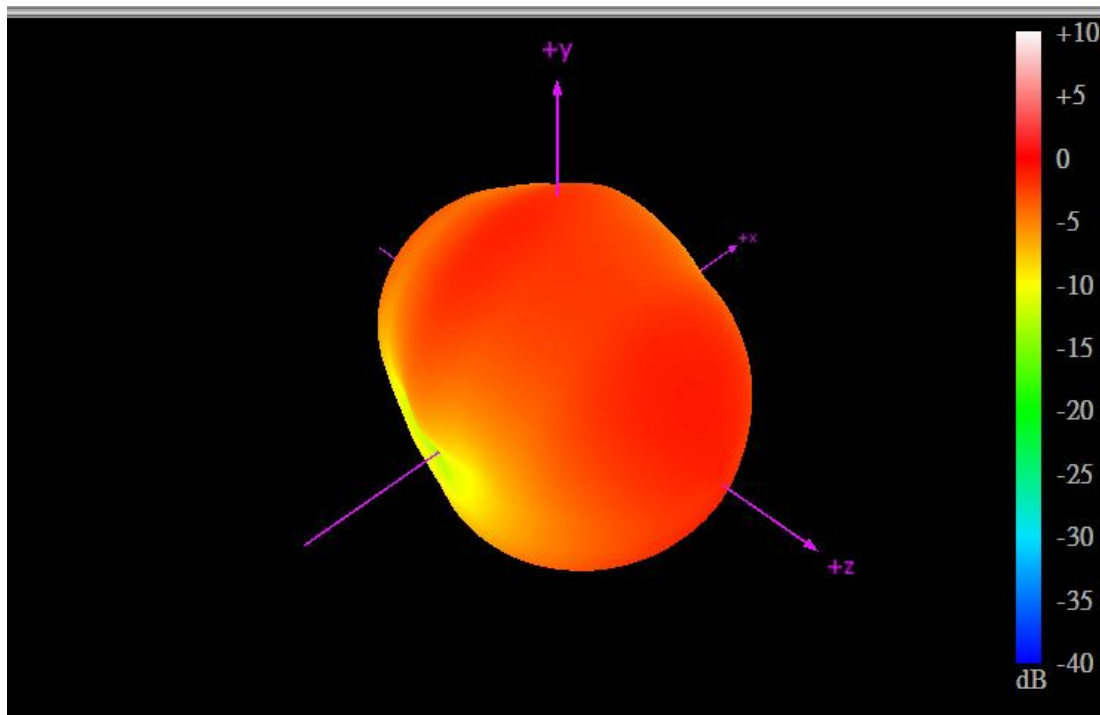

XZ Plane

YZ Plane

XY Plane

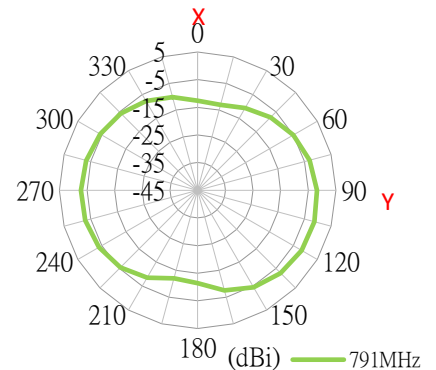
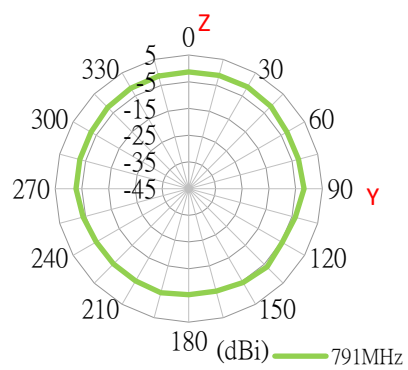
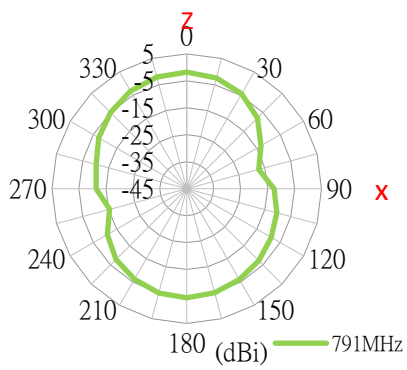

4.7 824 MHz 3D and 2D Radiation Patterns

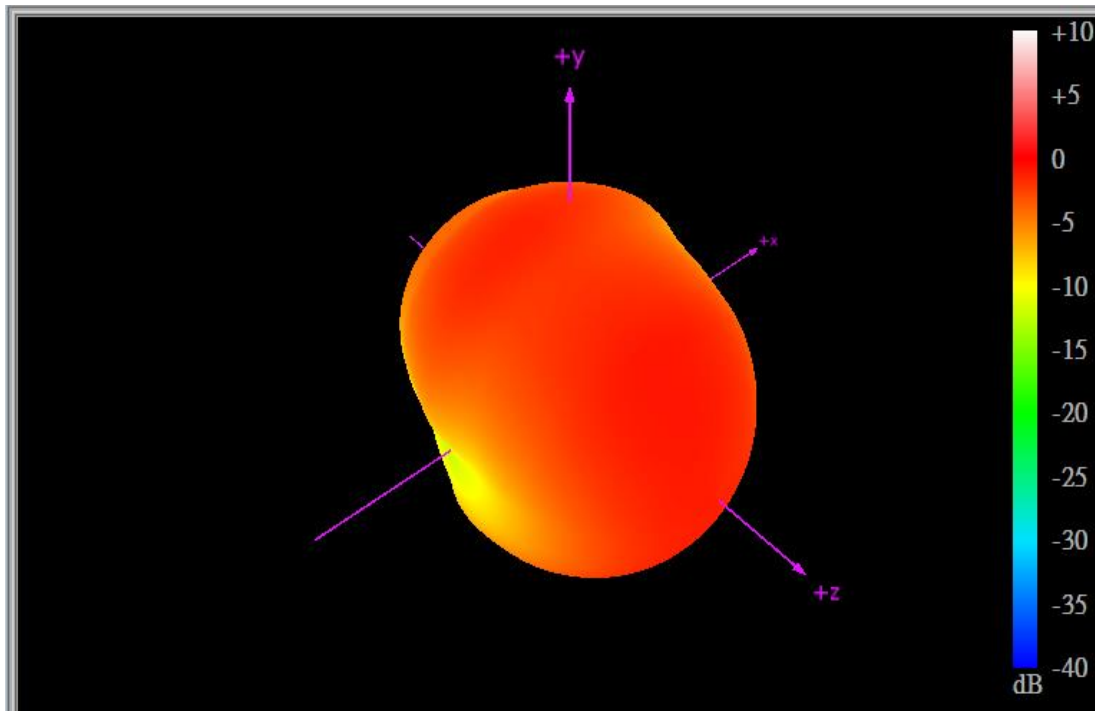

XZ Plane

YZ Plane

XY Plane

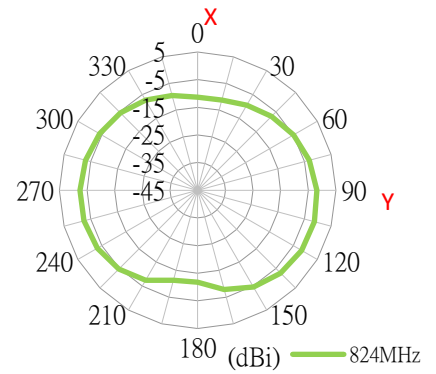
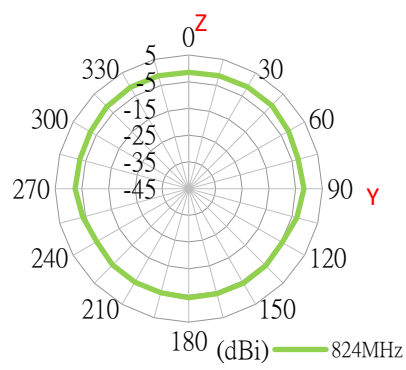
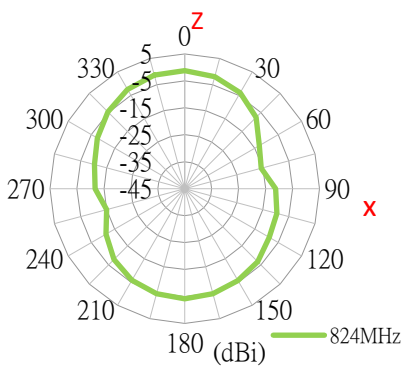

4.8 894 MHz 3D and 2D Radiation Patterns

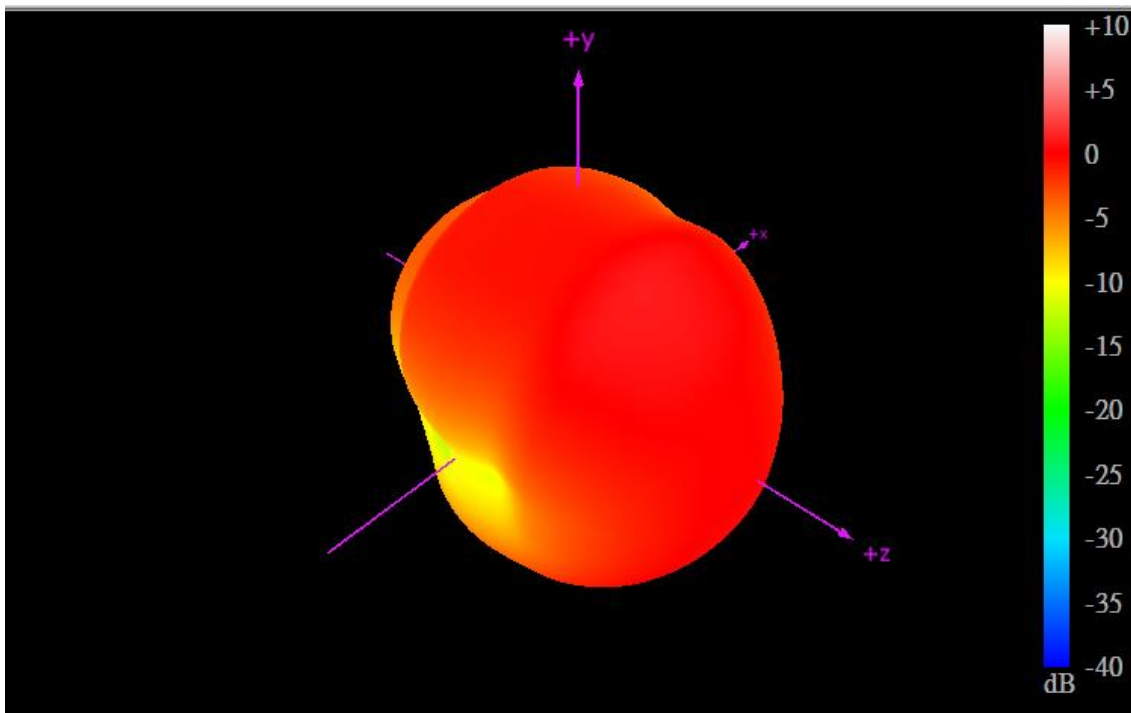

XZ Plane

YZ Plane

XY Plane

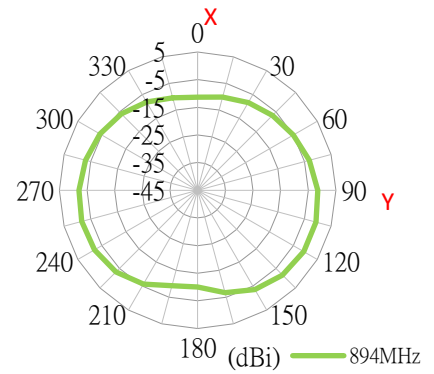
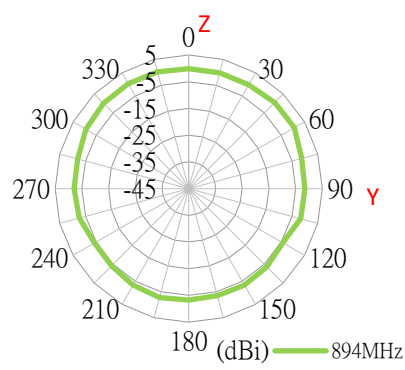
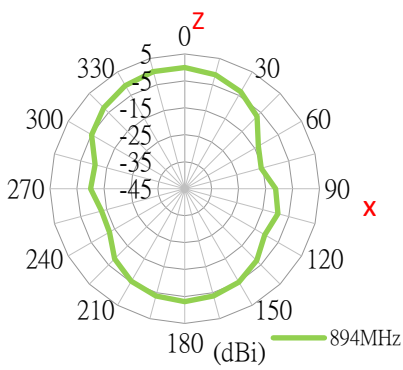



**4.9** 960 MHz 3D and 2D Radiation Patterns

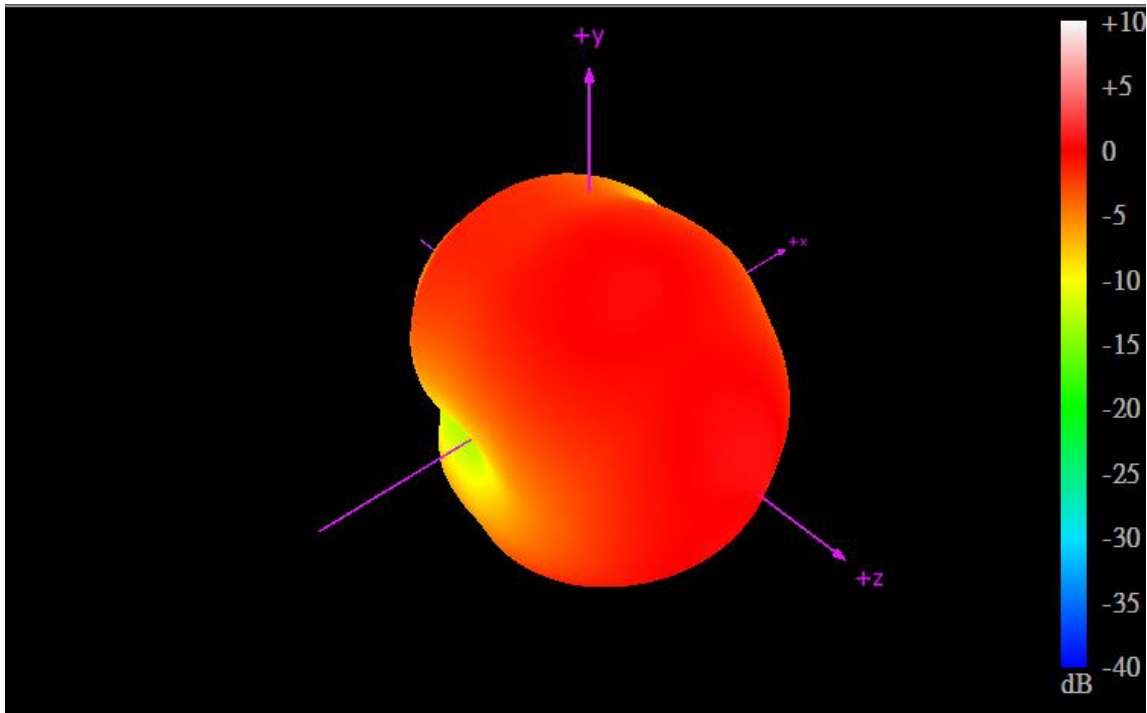

XZ Plane      YZ Plane      XY Plane

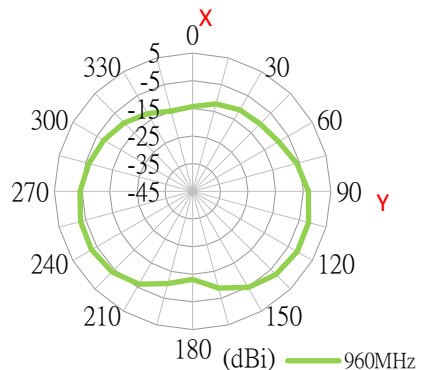
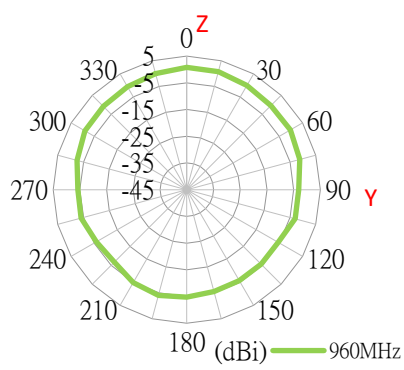
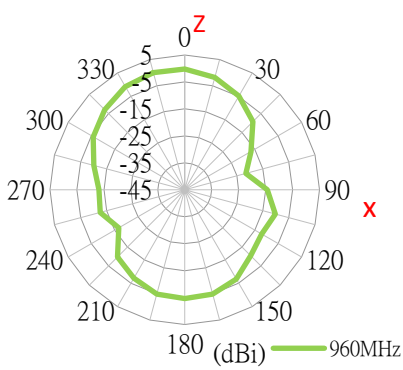

# 5. Mechanical Drawings(Units: mm)

## 5.1 Antenna Drawing

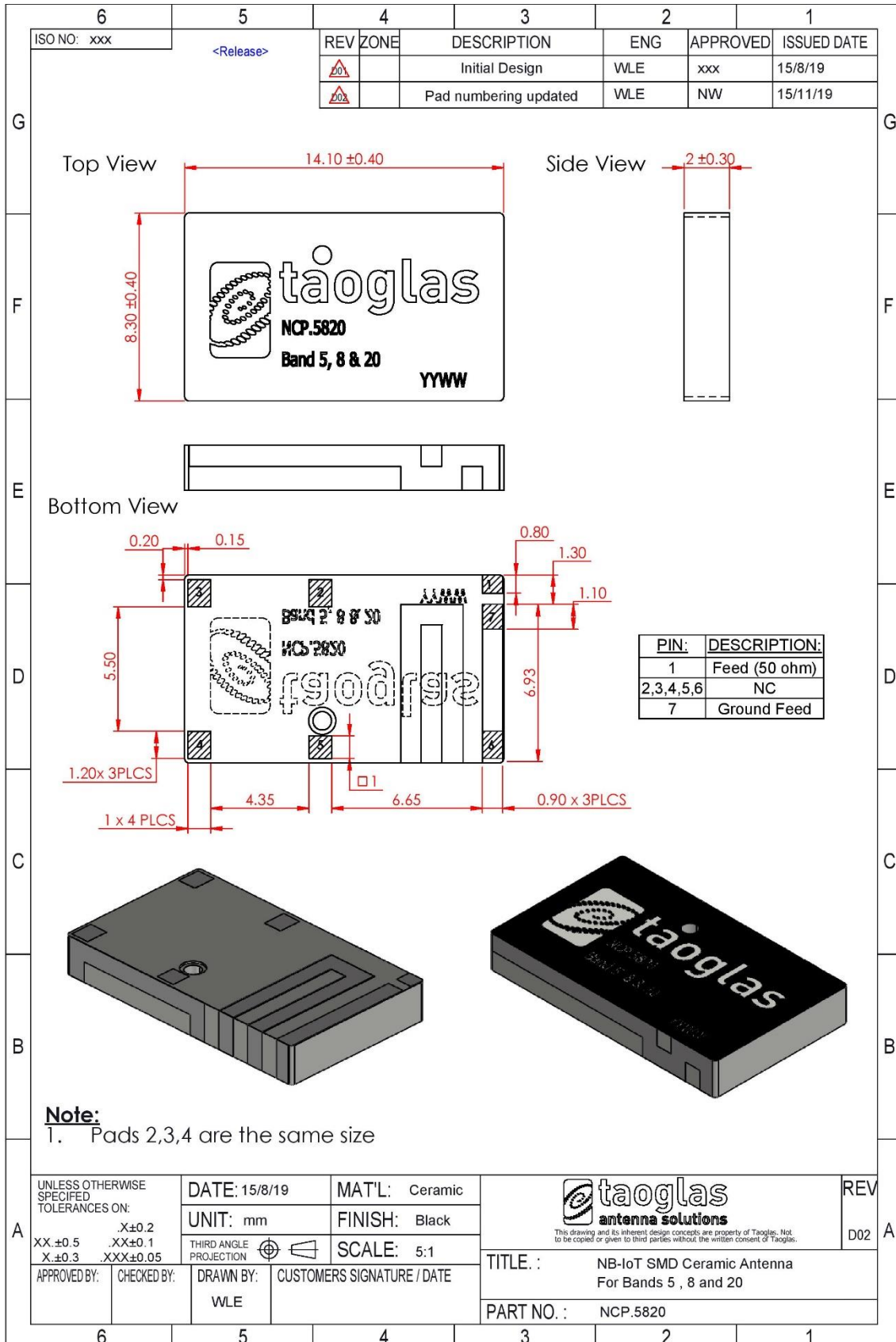

## 5.2 Paste Area

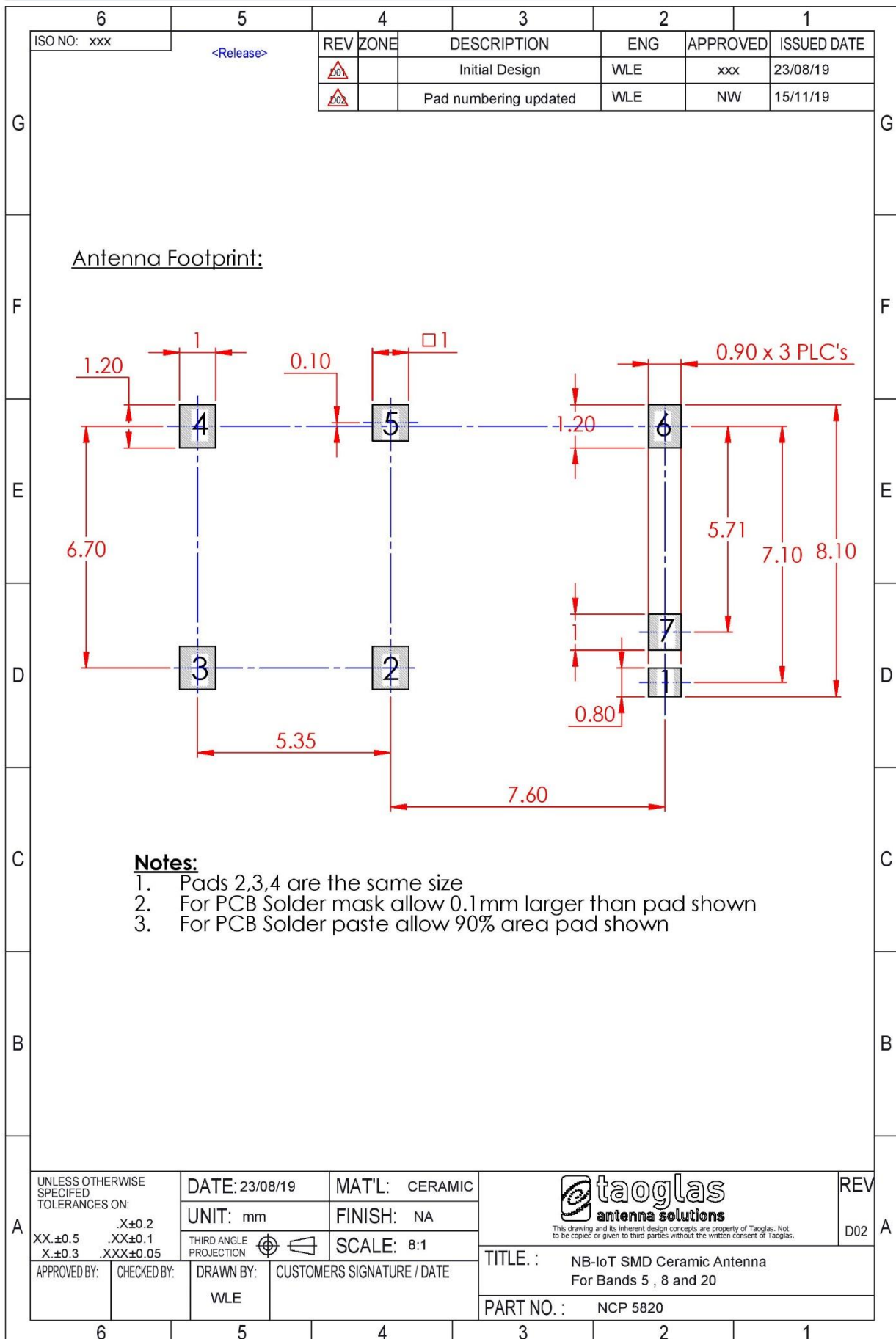

5.3 Copper Keep-Out Areas

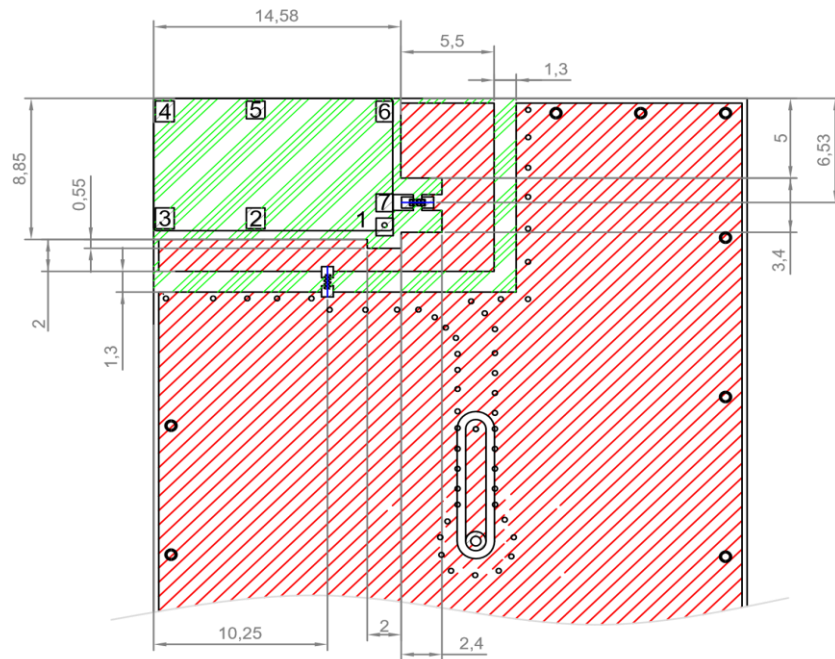

Top View (Keep-out area )

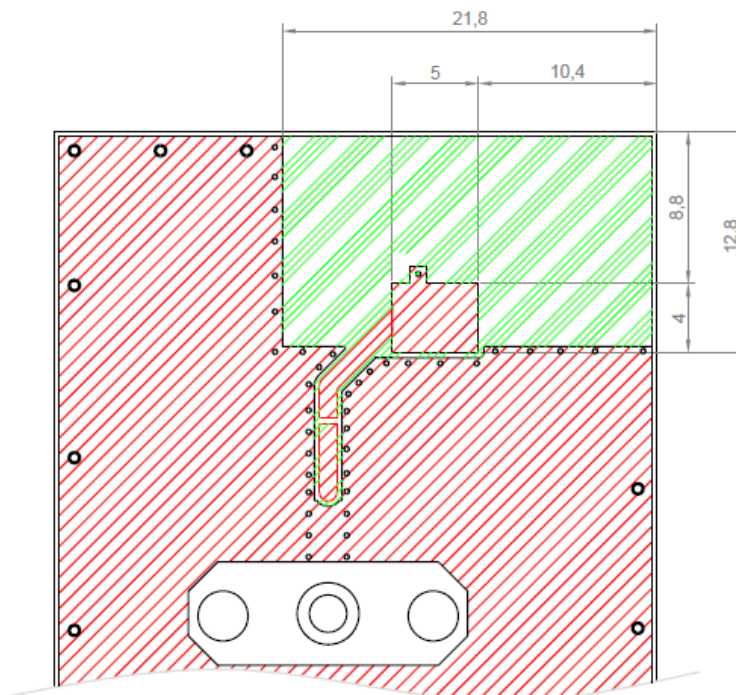

Bottom View (Keep-out area )

Note:

- 1. Soldered area
- 2. Copper area
- 3. Ground Clearance Area

## 5.4 Evaluation Board

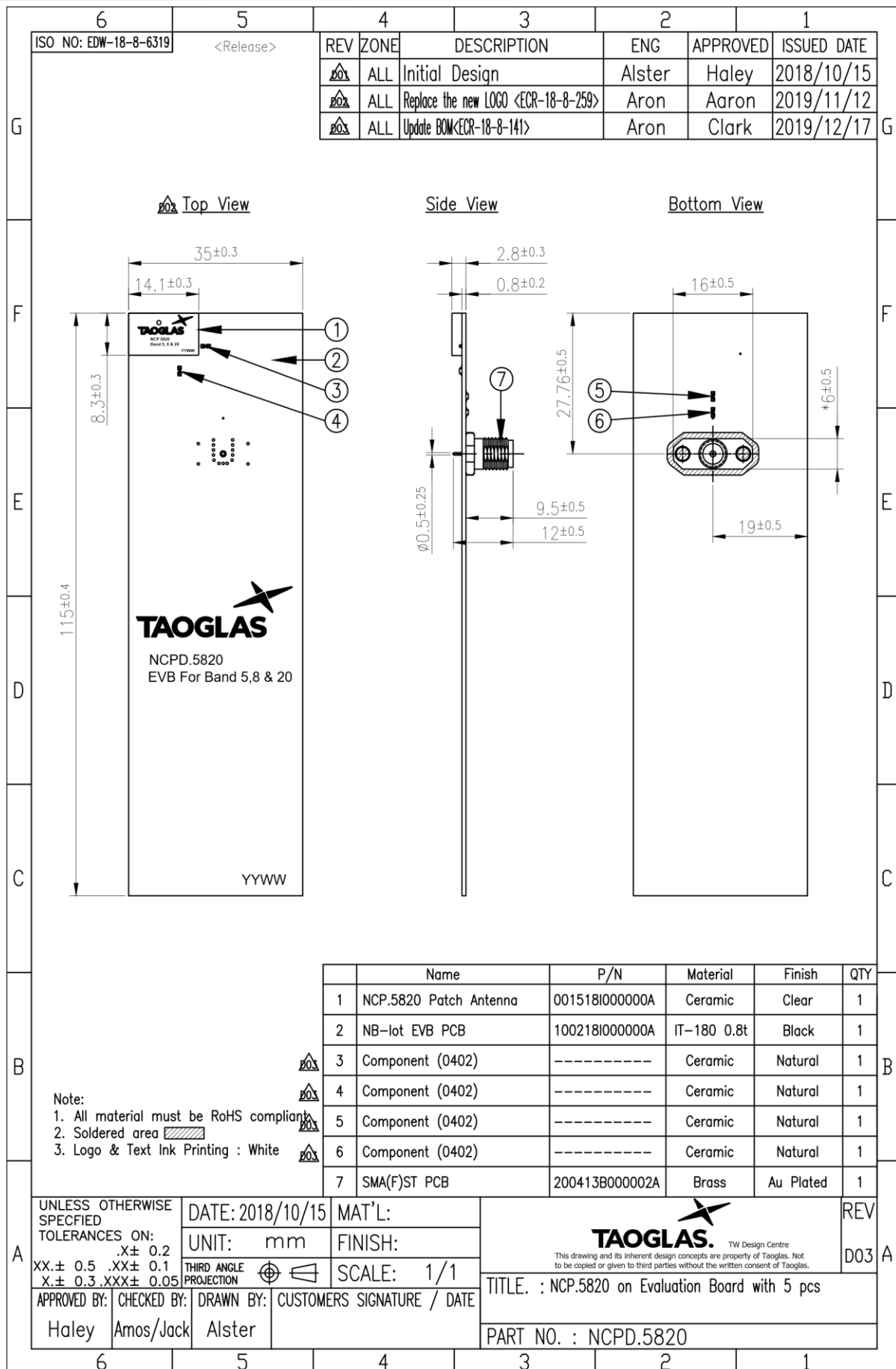

## 6. Antenna Integration Guide

### 6.1 Integration Guide

Whatever the size of the PCB, the ideal location for the antenna is as illustrated in the below diagram; on the PCB's shortest side, in the left corner. This allows placement of the optimized matching components alongside the antenna.

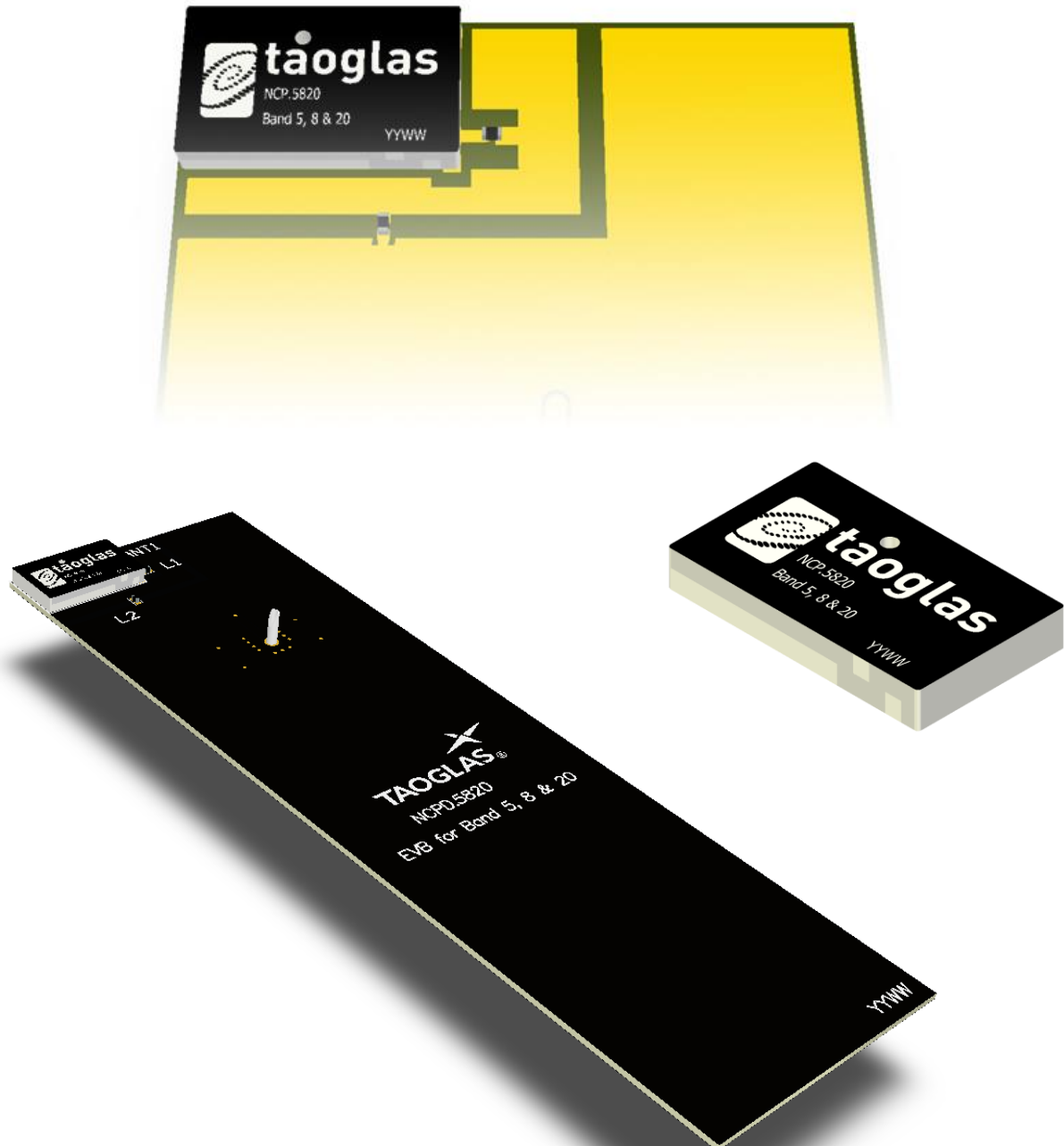

## 6.2 PCB Layout

The footprint and clearance on the PCB must comply with the antenna specification. The PCB layout shown in the diagram below demonstrates the antenna footprint and the clearance required. The component should be close to Pin 7.



Topside

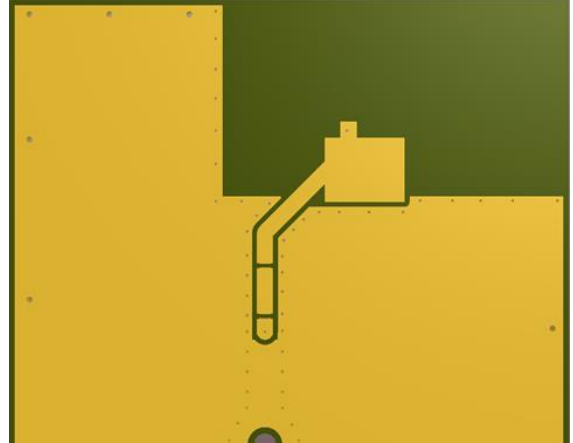

Bottom Side

## 6.3 PCB Clearance

In the figure in this section, the footprint and clearance are defined through all layers on the PCB. Only the antenna pads and connections to feed and GND are present within this clearance area (marked RED). The clearance area required is 14.6 x 8.9 (mm). An additional clearance area (marked BLACK) is also needed for the antenna to operate 21.4 x 12.2 (mm).

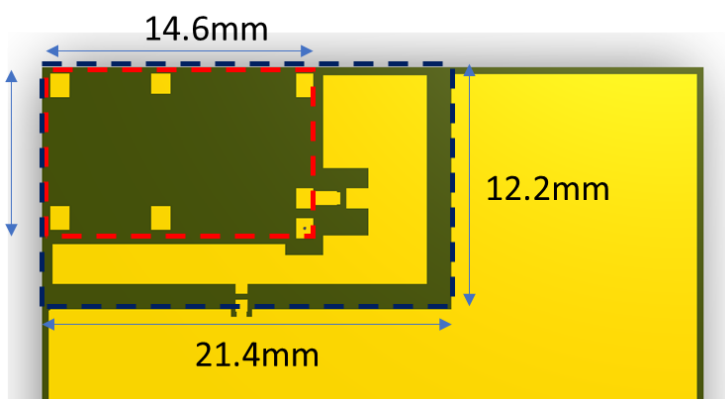

Topside

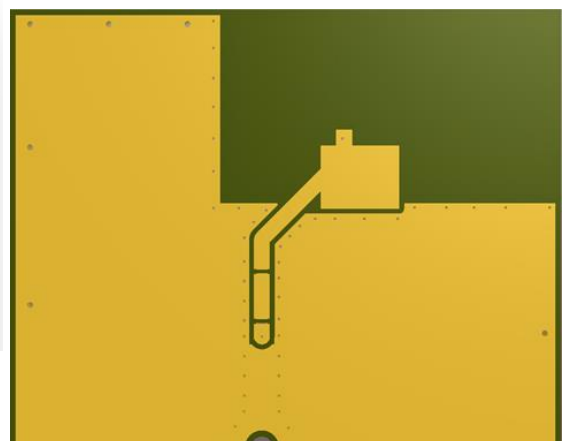

Bottom Side



## 6.4 Schematic Symbol and Pin Definitions

The circuit symbol for the antenna is shown below. The antenna has 7 pins with only two as functional. All other pins are for mechanical strength.

Pin	Description
1	RF Feed
7	Ground
2, 3, 4, 5, 6	Not Connected

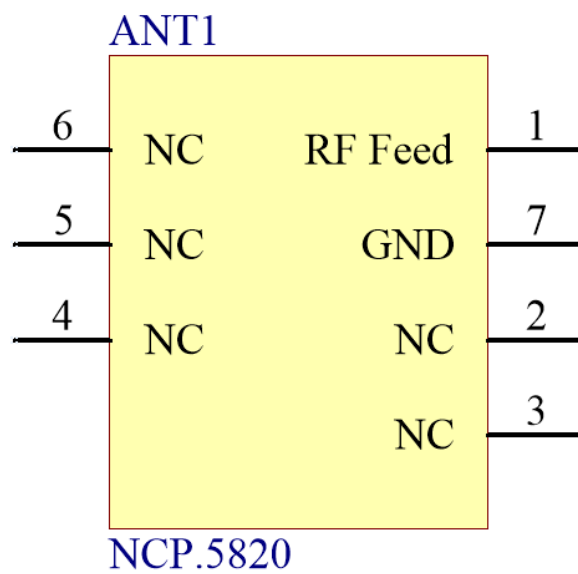



## 7. Evaluation Board Matching Circuit

The antenna may need a matching circuit that can be optimized for each product integration. The matching circuit will require up to four components and the following circuit should be designed into the PCB. Not all components may be required but should be included as a precaution. The matching network must be placed close to the antenna feed to ensure it is more effective for matching the antenna.

Band 5, 8 and 20 Matching Components

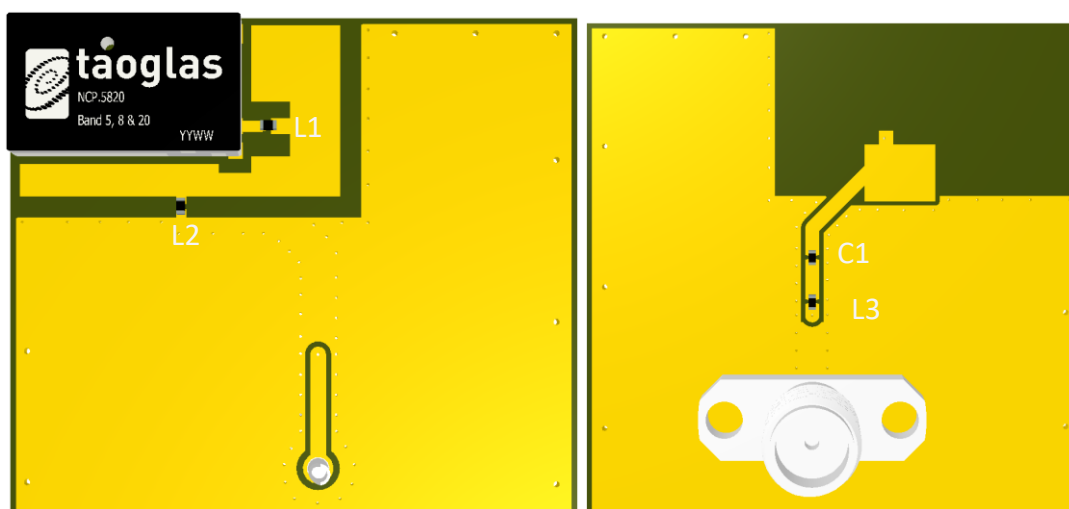
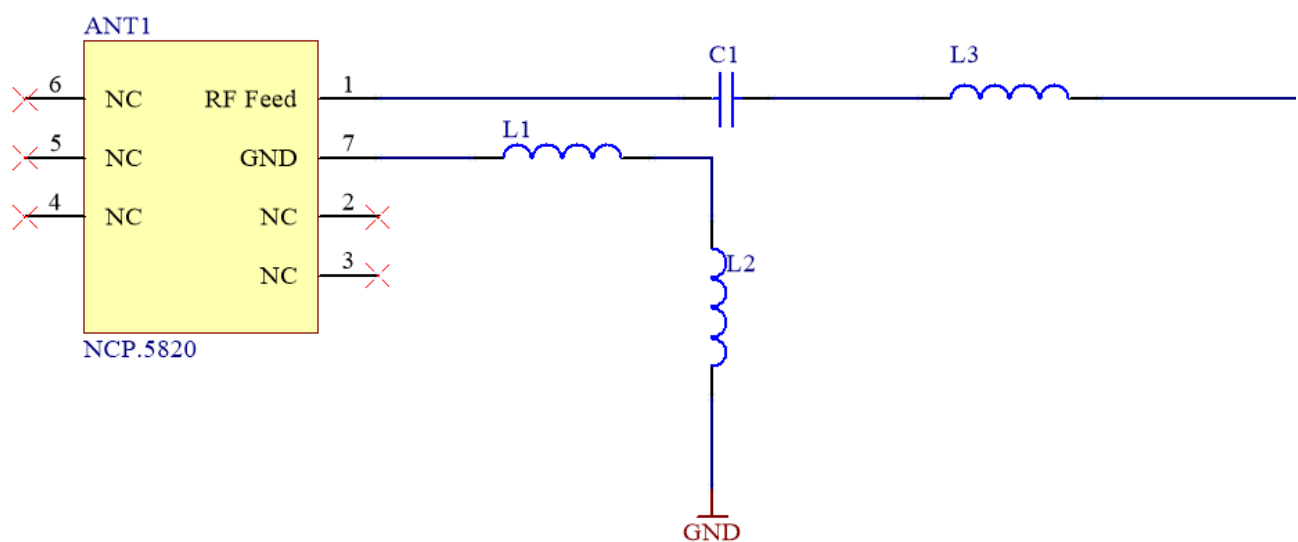

Band 5,8 and 20 Matching Components

Designator	Type	Value	Description
C1	Capacitor	0.5pF	Murata GJM1555 series
L1	Inductor	1.5nH	Murata LQG15HS series
L2	Inductor	6.8nH	Murata LQG15HS series
L3	Inductor	33nH	Murata LQG15HS series

### Band 5, 8 Matching Components

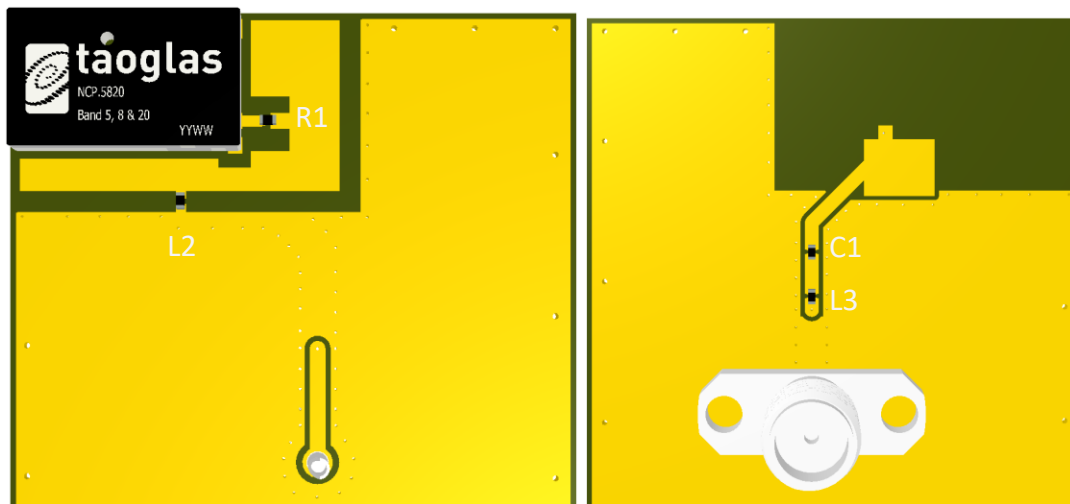
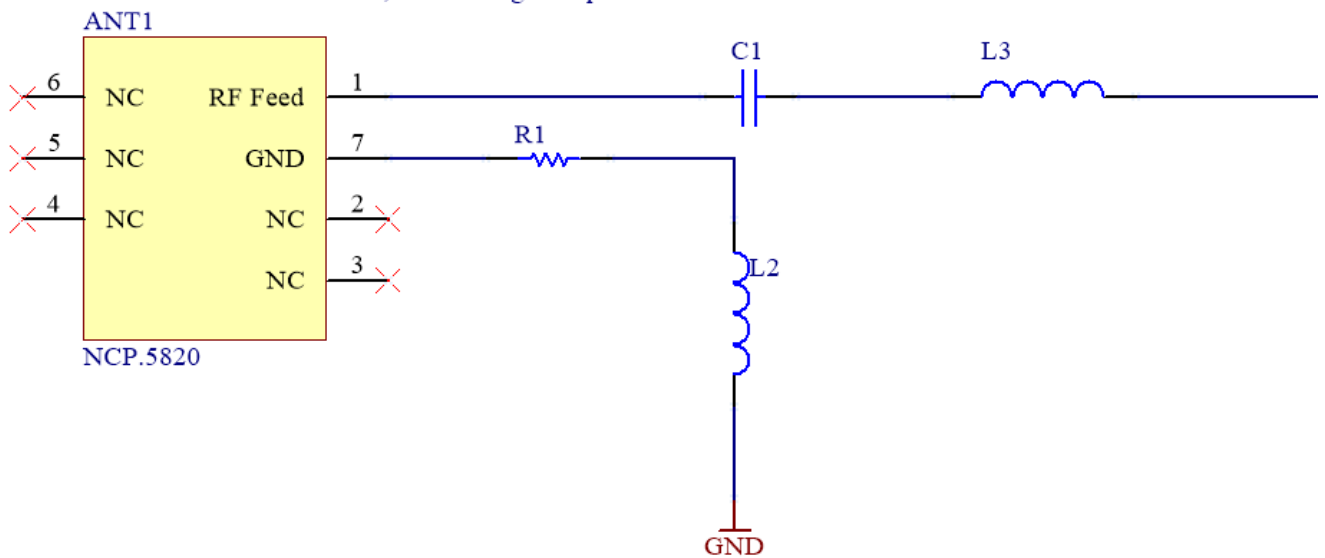

### Band 5,8 Matching Components

Designator	Type	Value	Description
C1	Capacitor	0.5pF	Murata GJM1555 series
L2	Inductor	5.6nH	Murata LQG15HS series
L3	Inductor	33nH	Murata LQG15HS series
R1	Resistor	0 Ω	Vishay Dale CRCW0402 series

## 8. Packaging

700pcs NCP.5820 per Tape & Reel  
 Dimensions: 330\*\*330\*47mm  
 Weight: 1.1Kg

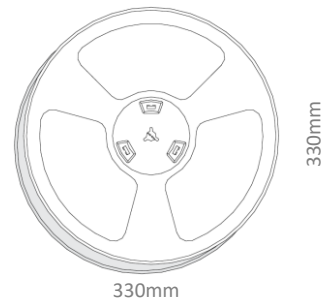

3500 pcs in one carton  
 Dimensions: 370\*360\*275mm  
 Weight: 5.6Kg

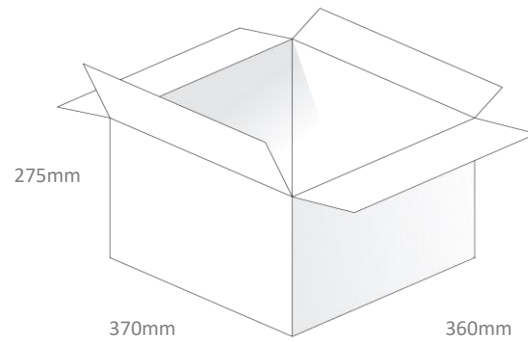

Changelog for the datasheet

**SPE-18-8-098 – NCP.5820**

**Revision: I (Current Version)**

Date:	2021-09-15
Changes:	Added MSL information
Author:	Erik Landi

**Previous Revisions**

**Revision: H**

Date:	2019-12-17
Changes:	Updated Eval drawings
Author:	Jack Conroy

**Revision: C**

Date:	2018-10-11
Changes:	Added Automotive IATF16949
Changes Made by:	Sean Hancox

**Revision: G**

Date:	2019-12-11
Changes:	Updated Matching Circuit
Changes Made by:	Jack Conroy

**Revision: B**

Date:	2018-09-27
Changes:	Updated Packaging spec sheet
Changes Made by:	Russell Meyler

**Revision: F**

Date:	2019-09-19
Changes:	Updated template, updated footprint
Changes Made by:	Jack Conroy

**Revision: A**

Date:	2018-09-11
Changes:	Initial Datasheet Release
Changes Made by:	Jack Conroy

**Revision: E**

Date:	2018-12-13
Changes:	Added Pin layout
Changes Made by:	Jack Conroy

**Revision: D**

Date:	2018-12-04
Changes:	Added Automotive IATF16949
Changes Made by:	Jack Conroy