

# NCP1060FLBKGEVB

## NCP1060 Flyback Converter Evaluation Board User's Manual



ON Semiconductor®

[www.onsemi.com](http://www.onsemi.com)

### Universal AC Mains, Up to 7 Watt Isolated Power Supply

### EVAl BOARD USER'S MANUAL

#### Introduction

This evaluation board manual describes a simple, low power (up to 7 W), universal AC mains Flyback converter. The converter provides constant voltage output. The supply can be used for powering utility electric meters, white goods or similar industrial equipments where isolation from the AC mains is required. The main benefits of provided solution are high efficiency, cost effectiveness and low no-load power consumption. The converter is utilizing monolithic ON Semiconductor switcher NCP1060 with integrated 34  $\Omega$  MOSFET in a PDIP7 package. The evaluation board manual provides complete circuit diagram and bill of materials. The current capability of provided converter is user adjustable.

#### Circuit Description

The varistor R4 together with resistor R3 form simple protection that enhances application robustness against line over-voltage and voltage spikes. Resistor R3 also limits the inrush current when the power supply is connected to mains. The EMC filter is implemented to reduce conducted electromagnetic emissions to the mains.

The Flyback converter itself is formed by the high voltage switching regulator IC1, transformer TR1, freewheeling diode D3 and coil L1 (L3). Capacitors C5, C6, C7 and C8 are used as the output filtering and energy storage bank. Resistor R1 and capacitor C2 for filter, C1, R2 and D2 are forming voltage clamp for the switcher drain. Opto-coupler OK1 (NCP431) is used in feedback network. Resistors R8, R12 and R13 form resistive divider and sets output voltage.

Diode D7 and resistor R14 provide supply voltage for IC1 Vcc from auxiliary winding. The capacitor C10 is the energy storage element that keeps IC1 powered during light load conditions, when the switching frequency drops and energy from auxiliary winding refills Vcc capacitors less often.

Pin LIM/OPP is connected through resistor R6 to auxiliary winding and sets over-power protection. Resistor R9 decreases maximal peak current. The frequency compensation of the feedback loop system is ensured by external capacitor C8 that is connected to the IC OTA output.

#### Key Features

- Universal AC Input Range (85 – 265 Vac)
- Input Filter for Conducted EMI Attenuation
- Very Low Standby and No-load Power Consumption
- Frequency Fold-back for Improved Efficiency at Light Load
- Inherent Over-current, Over-voltage and Over-temperature Protections
- Frequency Jittering for Better EMI Signature
- Adjustable Peak Current to Set the Required Level of Over-current Protection

Table 1.

Description	Output Specification
Output Voltage	12 Vdc
Output Ripple	< 25 mV @ Full Load
Max Output Current	0.6 A
Min Output Current	0 A
Efficiency	See Efficiency Charts
Input Protection	Fuse
Operating Temperature Range	0°C to +50°C
Cooling Method	Passive Cooling
No-load Power Consumption	< 75 mW @ 85 – 265 Vac

Table 2.

Device	Application	Input Voltage	Output Power	Topology	I/O Isolation
NCP1060AP060G	White Goods, E-Meters	85 to 265 Vac	5 to 7 W	Flyback	Yes

# NCP1060FLBKGEVB

## CIRCUIT DIAGRAM

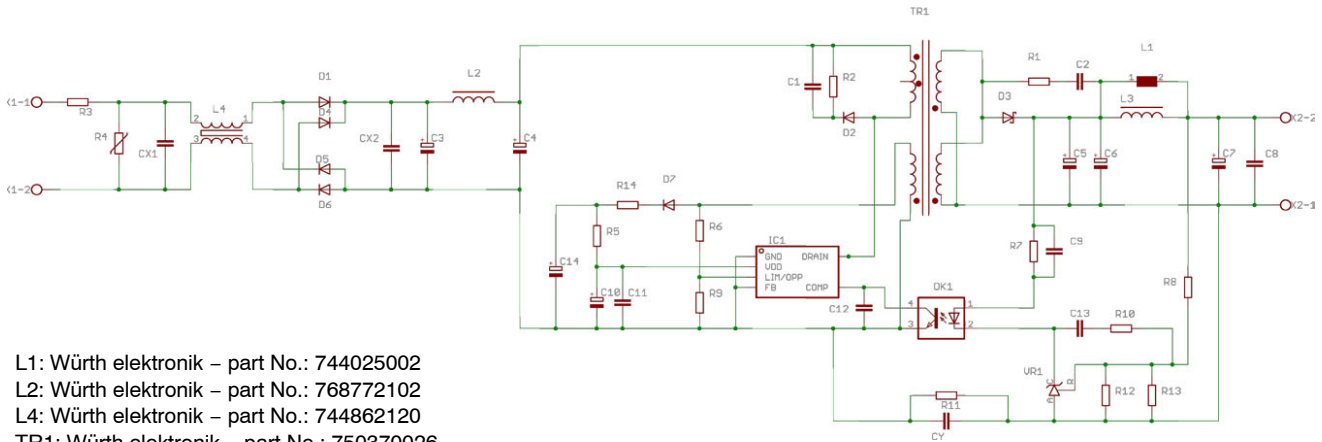

L1: Würth elektronik – part No.: 744025002  
L2: Würth elektronik – part No.: 768772102  
L4: Würth elektronik – part No.: 744862120  
TR1: Würth elektronik – part No.: 750370026

Figure 1. Circuit Diagram

## EVALUATION BOARD

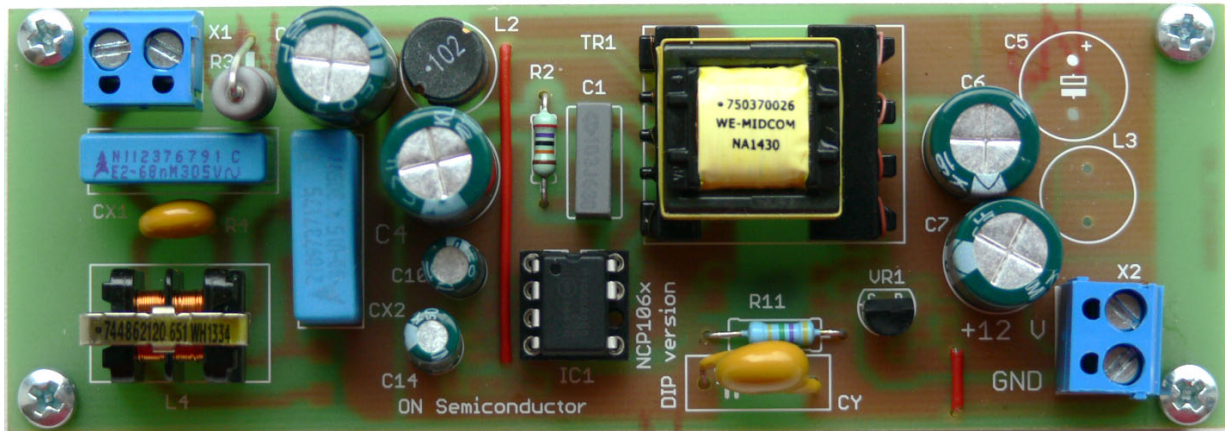

Figure 2. Evaluation Board – Top Side

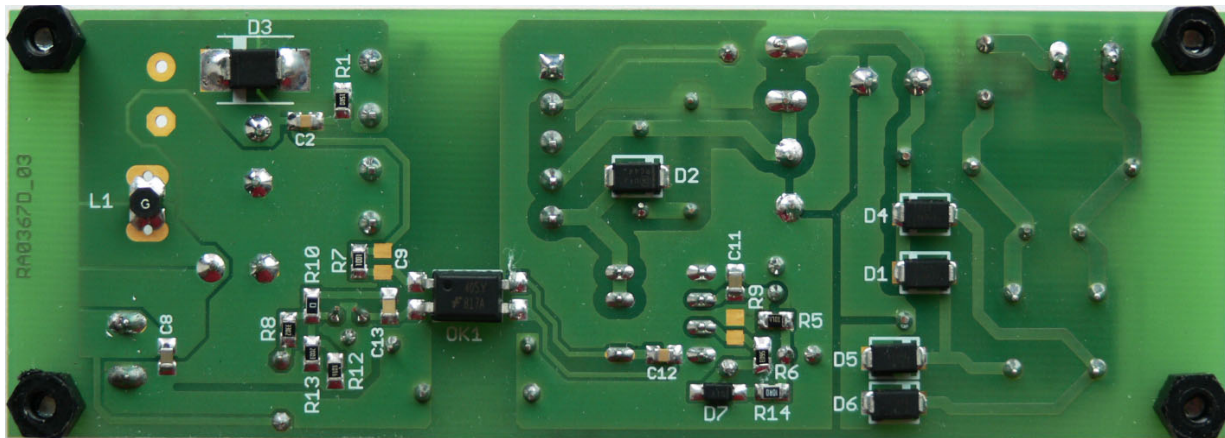

Figure 3. Evaluation Board – Bottom Side

# NCP1060FLBKGEVB

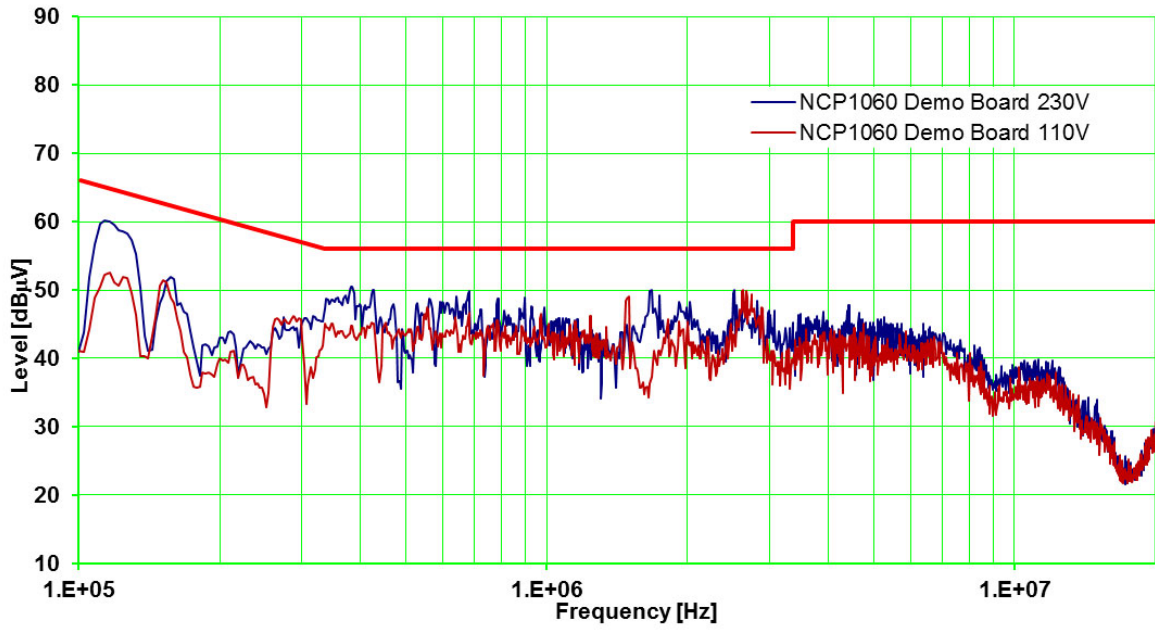

Figure 4. Conducted Emission Quasi-peak dBµV (Domestic)

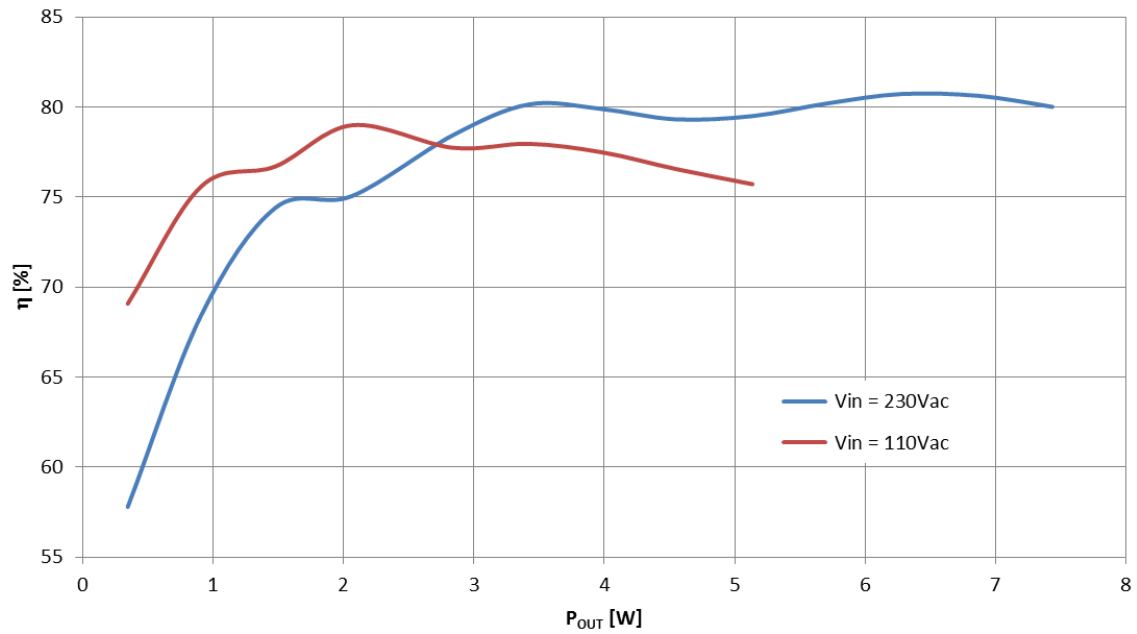

Figure 5. Efficiency vs. Output Load Curves

# NCP1060FLBKGEVB

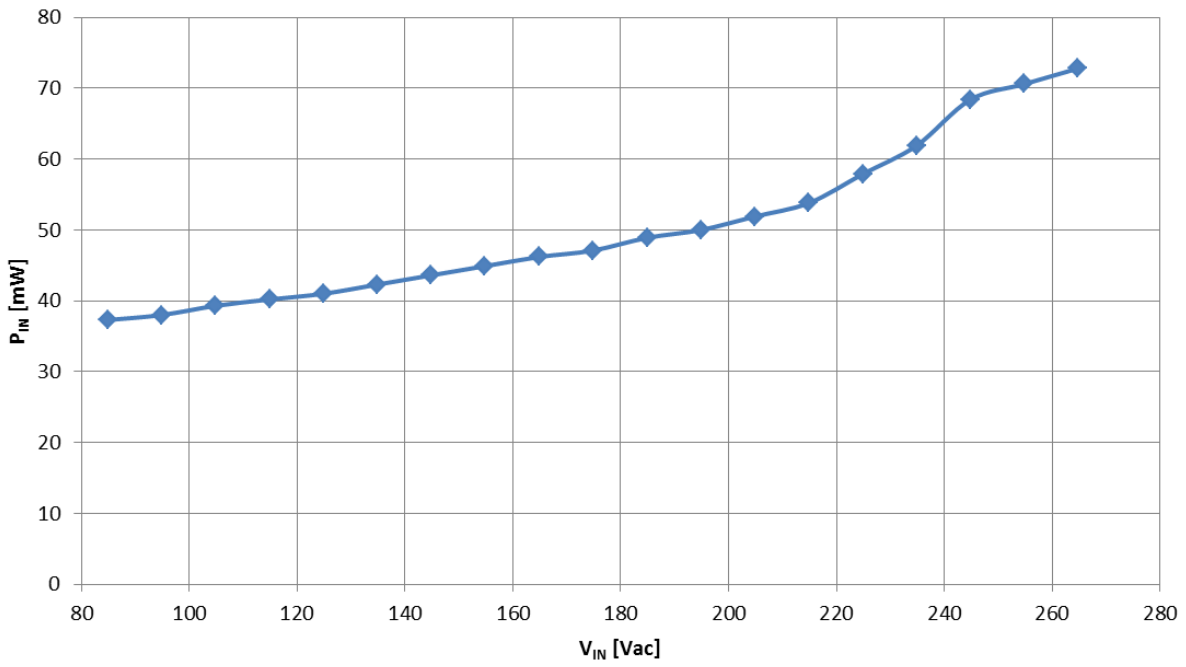

Figure 6. No-load Power Consumption vs. Line Input Curves

## OUTPUT RIPPLE VOLTAGE

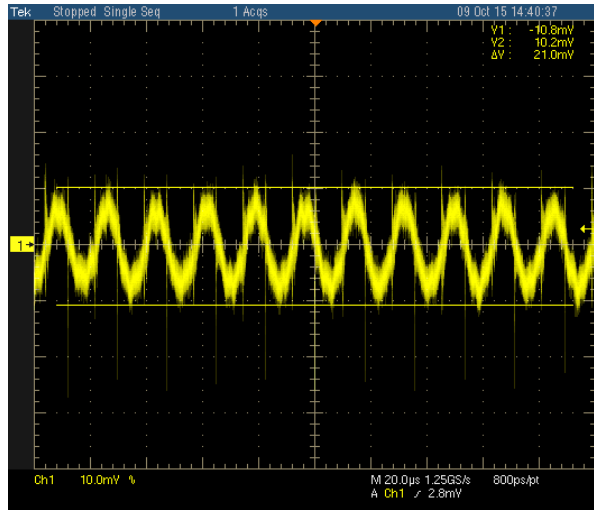

Figure 7. Input Voltage 85 Vac and 0.4 A Load

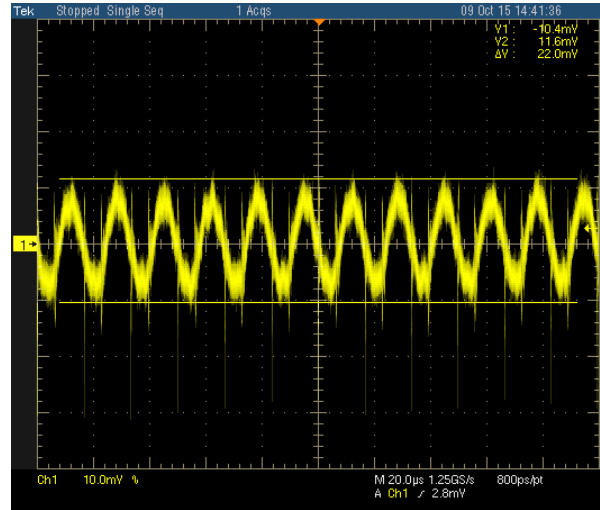

Figure 8. Input Voltage 110 Vac and 0.4 A Load

# NCP1060FLBKGEVB

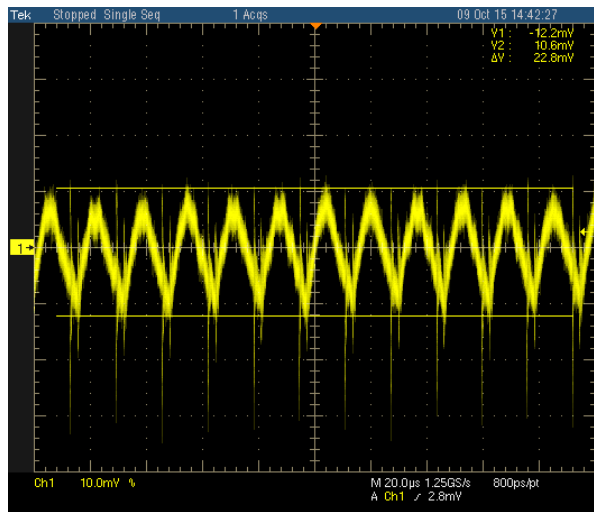

Figure 9. Input Voltage 230 Vac and 0.4 A Load

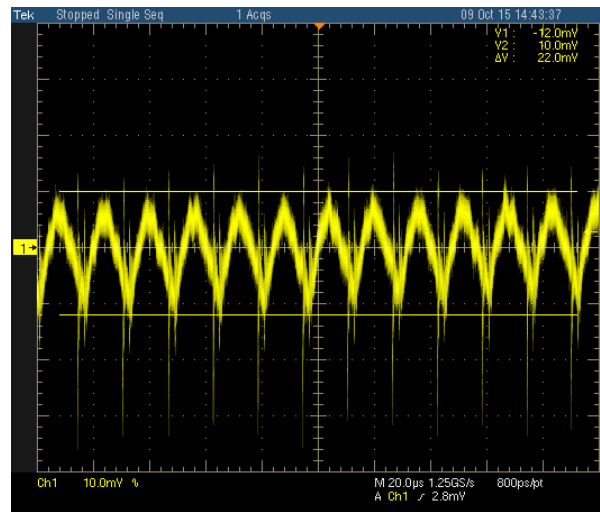

Figure 10. Input Voltage 265 Vac and 0.4 A Load

## TRANSIENT RESPONSE

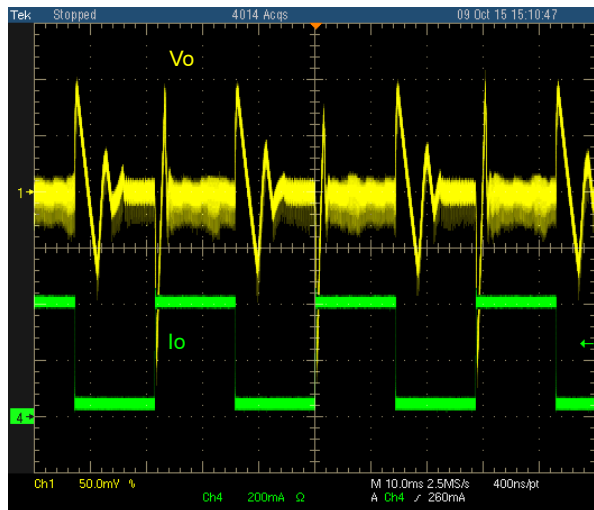

Figure 11. Test Condition: 30–400 mA, 28 ms Cycle, 110 Vac

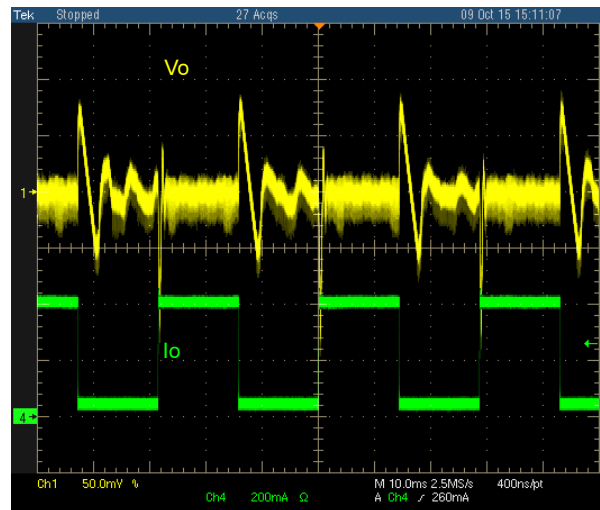

Figure 12. Test Condition: 30–400 mA, 28 ms Cycle, 230 Vac

# NCP1060FLBKGEVB

## STARTUP TIME

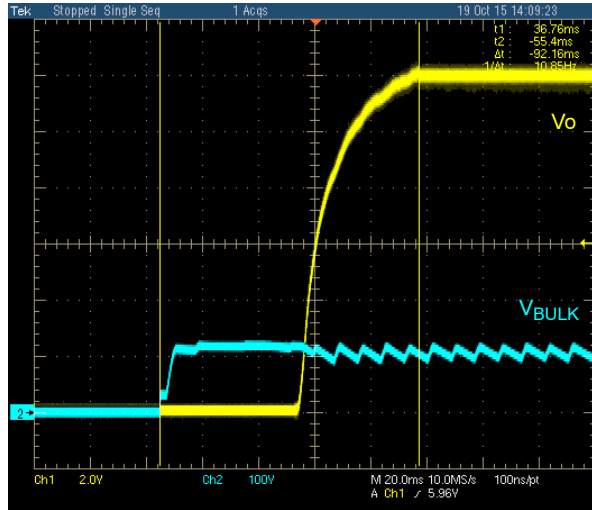

Figure 13. Input Voltage 85 Vac and 0.4 A Load

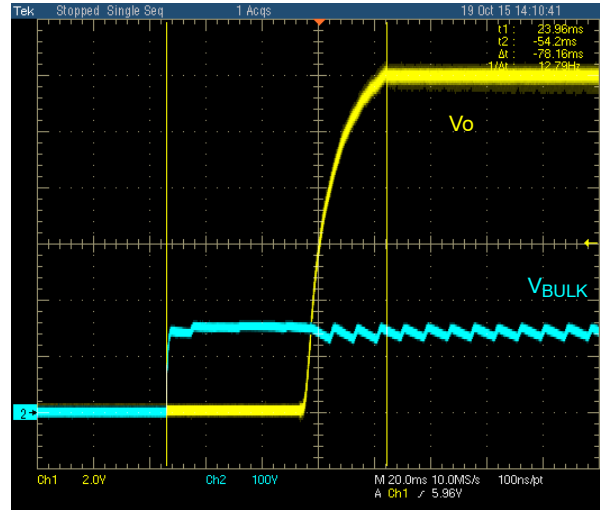

Figure 14. Input Voltage 110 Vac and 0.4 A Load

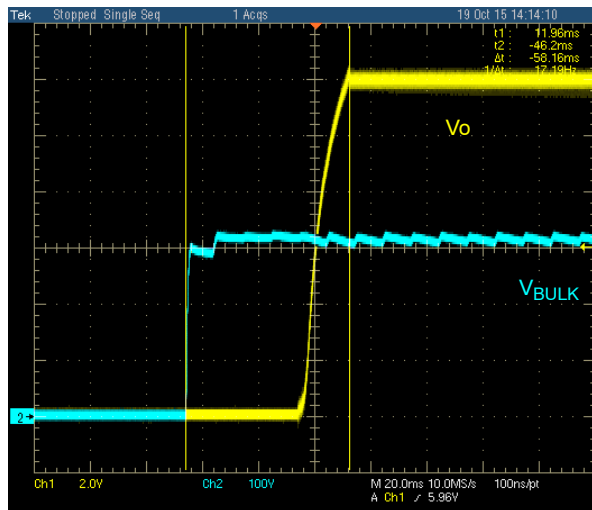

Figure 15. Input Voltage 230 Vac and 0.4 A Load

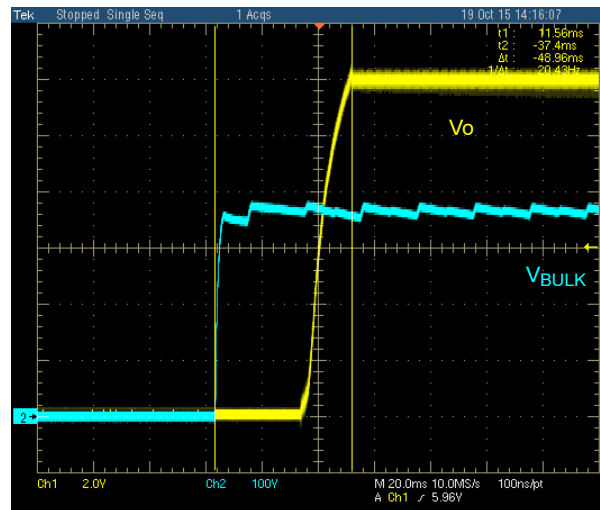

Figure 16. Input Voltage 265 Vac and 0.4 A Load

# NCP1060FLBKGEVB

## POWER OFF

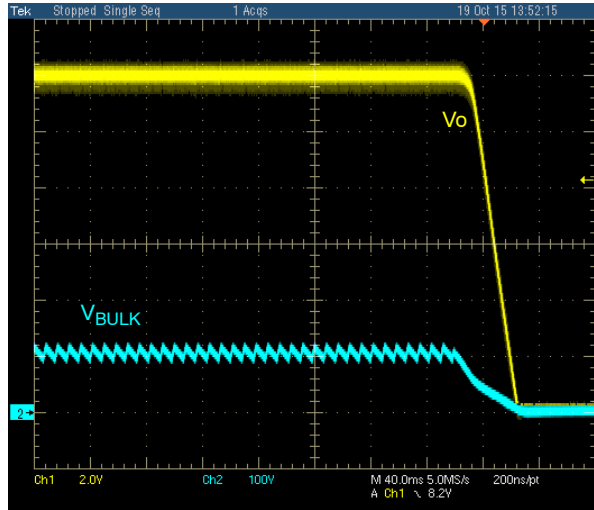

Figure 17. Input Voltage 85 Vac and 0.4 A Load

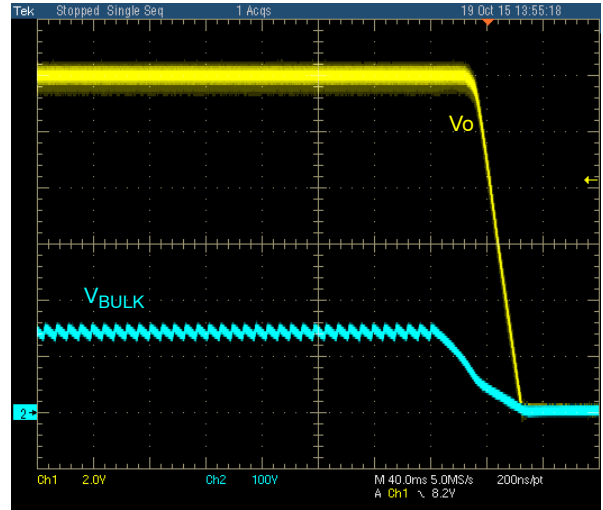

Figure 18. Input Voltage 110 Vac and 0.4 A Load

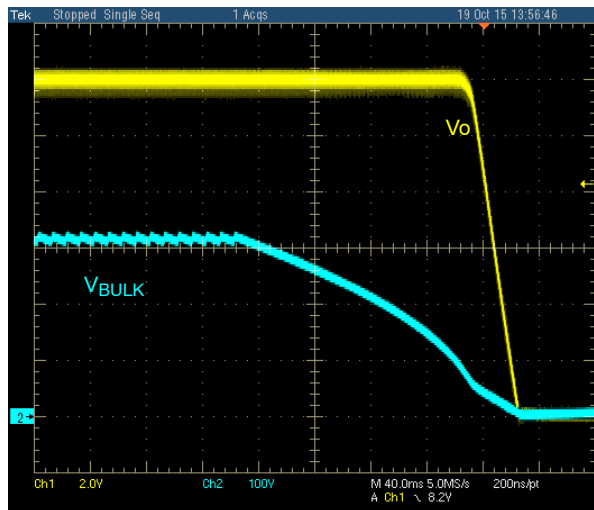

Figure 19. Input Voltage 230 Vac and 0.4 A Load

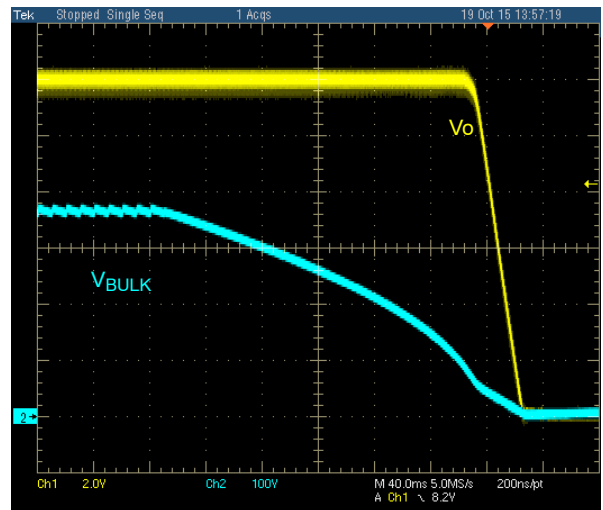

Figure 20. Input Voltage 265 Vac and 0.4 A Load

# NCP1060FLBKGEVB

**Table 3. BILL OF MATERIALS**

Designator	Qty	Description	Value	Tolerance	Footprint	Manufacturer	Manufacturer Part Number	Substitution Allowed
C1	1	Capacitor	10 nF	10%	Through hole	Vishay BC Components	BFC237261103	Yes
C2	1	Ceramic Capacitor	1.0 nF	10%	805	Kemet	C0805C102K5RACTU	Yes
C3, C4	2	Electrolytic Capacitor	10 $\mu$ F / 400 V	20%	Through hole	Würth Elektronik	860011375006	Yes
C5	1	Electrolytic Capacitor	NU		Through hole			
C6	1	Electrolytic Capacitor	470 $\mu$ F / 16 V	20%	Through hole	Würth Elektronik	870235375008	Yes
C7	1	Electrolytic Capacitor	470 $\mu$ F / 16 V	20%	Through hole	Würth Elektronik	870235375008	Yes
C8, C11	2	Ceramic Capacitor	100 nF	10%	805	Kemet	C0805C104K5RAC	Yes
C9	1	Ceramic Capacitor	NU		805			
C10	1	Electrolytic Capacitor	10 $\mu$ F / 35 V	20%	Through hole	Würth Elektronik	870055673001	Yes
C12	1	Ceramic Capacitor	2.2 nF	10%	805	Kemet	C0805C222K5RACTU	Yes
C13	1	Ceramic Capacitor	12 nF	10%	805	Kemet	C0805C123K5RACTU	Yes
C14	1	Electrolytic Capacitor	4.7 $\mu$ F / 35 V	20%	Through hole	Würth Elektronik	860010572001	Yes
CX1	1	Capacitor X2	68 nF	10%	Through hole	Würth Elektronik	890334025013CS	Yes
CX2	1	Capacitor X2	150 nF	10%	Through hole	Würth Elektronik	890334025022	Yes
CY	1	Capacitor X1Y1	1.0 nF	20%	Through hole	Murata	DE1E3KX102MA5BA01	Yes
D1, D4, D5, D6	4	Diode	MRA4007		SMA	ON Semiconductor	MRA4007T3G	No
D2	1	Diode	MURA160		SMA	ON Semiconductor	MURA160T3G	No
D3	1	Diode	MBRS1100		SMC	ON Semiconductor	MBRS1100T3G	No
D7	1	Diode	MMSD4148		SOD123	ON Semiconductor	MMSD4148T3G	No
IC1	1	Switcher	NCP1060		PDIP-7	ON Semiconductor	NCP1060AP060G	No
L1	1	Inductor	2.2 $\mu$ H		WE-TPC_2828	Würth Elektronik	744025002	No
L2	1	Inductor	1.0 mH		RFB0807	Würth Elektronik	768772102	No
L3	1	Inductor	NU		RFB0807			
L4	1	Common Mode Filter Choke	12 mH		WE-TFC	Würth Elektronik	744862120	No
OK1	1	Optocoupler	FOD817		SMD-4	Fairchild Semiconductor	FOD817CS	No
R1	1	Resistor	15 $\Omega$	1%	805	Rohm Semiconductor	MCR10ERTF15R0	Yes
R2	1	Resistor	270 k $\Omega$	1%	0207/10	Vishay Dale	CMF55270K00FKEB	Yes
R3	1	Resistor	20 $\Omega$	5%	613	Vishay BC Components	AC03000002009JAC00	Yes
R4	1	Varistor	820572711		Through hole	Würth Elektronik	820572711	No
R5	1	Resistor	4.7 k $\Omega$	1%	805	Rohm Semiconductor	MCR10ERTF4701	Yes
R6	1	Resistor	560 k $\Omega$	1%	805	Rohm Semiconductor	MCR10ERTF5603	Yes
R7	1	Resistor	1.0 k $\Omega$	1%	805	Rohm Semiconductor	MCR10ERTF1001	Yes



# NCP1060FLBKGEVB

**Table 3. BILL OF MATERIALS**

Designator	Qty	Description	Value	Tolerance	Footprint	Manufacturer	Manufacturer Part Number	Substitution Allowed
R8	1	Resistor	33 kΩ	1%	805	Rohm Semiconductor	MCR10ERTF3302	Yes
R9	1	Resistor	NU		805			Yes
R10	1	Resistor	0.0 Ω		805	Vishay Dale	CRCW08050000Z0EA	Yes
R11	1	Resistor	4.7 MΩ	5%	Axial Lead	Welwyn	VRW37-4M7JI	Yes
R12	1	Resistor	9.1 kΩ	1%	805	Rohm Semiconductor	MCR10ERTF9101	Yes
R13	1	Resistor	200 kΩ	1%	805	Rohm Semiconductor	MCR10ERTF2003	Yes
R14	1	Resistor	10 Ω	1%	805	Rohm Semiconductor	MCR10ERTF10R0	Yes
TR1	1	Transformer	750370026		Through hole	Würth Elektronik	750370026	No
VR1	1	Voltage Regulator	NCP431	1%	TO-92	ON Semiconductor	NCP431ACLPRAG	No
X1, X2	2	Wago Screw Clamp 237-102 unknown 70K9898	69110171000 2		Through hole	Würth Elektronik	691101710002	No
-	2	Wire Strap (insulated)	-		Wire strap	Various		Yes
Board Standoff	4	Hex Standoff M3 Nylon	8.0 mm			Harwin	R30-1610800	Yes

NOTE All components are lead free.

## REFERENCES

- [1] ON Semiconductor datasheet for [NCP1060](#) monolithic switcher
- [2] ON Semiconductor design notes [DN05012](#), [DN05017](#), [DN05018](#), [DN05028](#), [DN05029](#)
- [3] Würth Elektronik <http://www.we-online.com/>

## Disclaimer

ON Semiconductor is providing this Evaluation Board Manual “AS IS” and does not assume any liability arising from its use; nor does ON Semiconductor convey any license to its or any third party’s intellectual property rights. This document is provided only to assist customers in

evaluation of the referenced circuit implementation and the recipient assumes all liability and risk associated with its use, including, but not limited to, compliance with all regulatory standards. ON Semiconductor may change any of its products at any time, without notice.