

NTC Thermistors





EU RoHS Compliant

- All the products in this catalog comply with EU RoHS.
- EU RoHS is "the European Directive 2011/65/EU on the Restriction of the Use of Certain Hazardous Substances in Electrical and Electronic Equipment."
- For more details, please refer to our web page, "Murata's Approach for EU RoHS" (<https://www.murata.com/en-eu/support/compliance/rohs>).

Contents

Product specifications are as of February 2020.

| | |
|---|-----|
| Part Numbering | p2 |
| Basic Characteristics | p5 |
| <hr/> | |
| 1 Temperature Sensor and Compensation 0201 (0603) Size | p6 |
| <hr/> | |
| 2 Temperature Sensor and Compensation 0402 (1005) Size/NCP Series | p7 |
| Temperature Sensor and Compensation 0402 (1005) Size/NCU Series | p9 |
| <hr/> | |
| 3 Temperature Sensor and Compensation 0603 (1608) Size/NCP Series | p10 |
| Temperature Sensor and Compensation 0603 (1608) Size/NCU Series | p12 |
| <hr/> | |
| Temperature Sensor and Compensation Chip Type Standard Land Pattern Dimensions | p13 |
| Temperature Sensor and Compensation Chip Type Temperature Characteristics (Center Value) | p14 |
| Temperature Sensor and Compensation Chip Type ⚠Caution/Notice | p17 |
| Temperature Sensor and Compensation Chip Type Package | p21 |
| <hr/> | |
| 4 Temperature Sensor Thermo String Cooper Wire Type | p23 |
| Temperature Sensor Thermo String Nickel Copper Wire Type | p24 |
| Temperature Sensor Thermo String Type Specifications and Test Methods | p25 |
| <hr/> | |
| 5 Temperature Sensor Lead Type | p27 |
| Temperature Sensor Lead Type Specifications and Test Methods | p28 |
| <hr/> | |
| 6 Temperature Sensor Lead Insulation Type ... | p29 |
| Temperature Sensor Lead Insulation Type Specifications and Test Methods | p30 |
| <hr/> | |
| Temperature Sensor Thermo String/Lead Type Temperature Characteristics (Center Value) | p31 |
| Temperature Sensor Thermo String/Lead Type ⚠Caution/Notice | p32 |
| Temperature Sensor Thermo String/Lead Type Package | p34 |

Please check the MURATA website (<https://www.murata.com/>) if you cannot find a part number in this catalog.

● Part Numbering

NTC Thermistors for Temp. Sensor and Compensation Chip Type

(Part Number)

| | | | | | | | |
|----|---|----|----|-----|---|----|----|
| NC | P | 18 | XH | 103 | J | 03 | RB |
| ① | ② | ③ | ④ | ⑤ | ⑥ | ⑦ | ⑧ |

① Product ID

| Product ID | |
|------------|---------------------------|
| NC | NTC Thermistors Chip Type |

② Series

| Code | Series |
|------|---------------------------|
| P | Plated Termination Series |
| U | High Reliability Series |

③ Dimensions (L x W)

| Code | Dimensions (L x W) | EIA |
|------|--------------------|------|
| 03 | 0.60 x 0.30mm | 0201 |
| 15 | 1.00 x 0.50mm | 0402 |
| 18 | 1.60 x 0.80mm | 0603 |
| 21 | 2.00 x 1.25mm | 0805 |

④ Temperature Characteristics

| Code | Temperature Characteristics |
|------|-------------------------------|
| XC | Nominal B-Constant 3100–3149K |
| XF | Nominal B-Constant 3250–3299K |
| XH | Nominal B-Constant 3350–3399K |
| XM | Nominal B-Constant 3500–3549K |
| XQ | Nominal B-Constant 3650–3699K |
| XV | Nominal B-Constant 3900–3949K |
| XW | Nominal B-Constant 3950–3999K |
| WB | Nominal B-Constant 4050–4099K |
| WD | Nominal B-Constant 4150–4199K |
| WF | Nominal B-Constant 4250–4299K |
| WL | Nominal B-Constant 4450–4499K |
| WM | Nominal B-Constant 4500–4549K |

⑤ Resistance

Expressed by three-digit alphanumerics. The unit is ohm (Ω). The first and second figures are significant digits, and the third figure expresses the number of zeros that follow the two figures.

Ex.

| Code | Resistance |
|------|---------------|
| 102 | 1k Ω |
| 103 | 10k Ω |
| 104 | 100k Ω |

⑥ Resistance Tolerance

| Code | Resistance Tolerance |
|------|----------------------|
| D | $\pm 0.5\%$ |
| F | $\pm 1\%$ |
| E | $\pm 3\%$ |
| J | $\pm 5\%$ |

⑦ Individual Specifications

Structures and other specifications are expressed by two figures.

Ex.

| Code | Individual Specifications |
|----------------------------|---------------------------|
| 03/05/10/12/60 | Standard Type |
| <input type="checkbox"/> S | Automotive Type |

⑧ Packaging

| Code | Packaging |
|------|--------------------------------------|
| RA | Plastic Taping 4mm Pitch (4000 pcs.) |
| RB | Paper Taping 4mm Pitch (4000 pcs.) |
| RC | Paper Taping 2mm Pitch (10000 pcs.) |
| RL | Paper Taping 2mm Pitch (15000 pcs.) |

NTC Thermistor for Temperature Sensor Thermo String Type

(Part Number)

| | | | | | | | | | |
|------------|----------|-----------|-----------|------------|----------|----------|----------|----------|------------|
| NXF | T | 15 | XH | 103 | F | A | 2 | B | 025 |
| ① | ② | ③ | ④ | ⑤ | ⑥ | ⑦ | ⑧ | ⑨ | ⑩ |

① Product ID

| Product ID | |
|------------|---|
| NXF | NTC Thermistors Sensor Thermo String Type |

② Individual Specifications

| Code | Individual Specifications |
|----------|---------------------------|
| T | Commercial Type |

③ Chip Dimensions

| Code | Dimensions (L x T) | EIA |
|-----------|--------------------|------|
| 15 | 1.00 x 0.50mm | 0402 |

④ Temperature Characteristics

| Code | Temperature Characteristics |
|-----------|-------------------------------|
| XH | Nominal B-Constant 3350–3399K |
| XM | Nominal B-Constant 3500–3549K |
| XV | Nominal B-Constant 3900–3949K |
| WB | Nominal B-Constant 4050–4099K |
| WF | Nominal B-Constant 4250–4299K |

⑤ Resistance

Expressed by three figures. The unit is (Ω). The first and second figures are significant digits, and the third figure expresses the number of zeros that follow the two figures.

Ex.

| Code | Resistance |
|------------|------------|
| 103 | 10kΩ |
| 473 | 47kΩ |
| 104 | 100kΩ |

⑥ Resistance Tolerance

| Code | Resistance Tolerance |
|----------|----------------------|
| F | ±1% |
| E | ±3% |

⑦ Lead Wire Type

| Code | Lead Wire Type |
|----------|---|
| A | ∅0.3mm Copper Lead Wire with Polyurethane Coat |
| E | ∅0.3mm Nickel Copper Lead Wire with Modified Polyester Coat |

⑧ Shape of the Lead Wire Kink

| Code | Shape of the Lead Wire Kink |
|----------|---|
| 1 | Twisted Lead Wire Type |
| 2 | Standard Type (Cooper Wire Type) |
| A | Standard Type (Nickel Copper Wire Type) |

⑨ Packaging

| Code | Packaging |
|----------|-----------|
| B | Bulk |

⑩ Dimensions (Full Length)

| Code | Dimensions (Full Length) |
|------------|--------------------------|
| 021 | 21mm |
| 025 | 25mm |
| 030 | 30mm |
| 035 | 35mm |
| 040 | 40mm |
| 045 | 45mm |
| 050 | 50mm |
| 060 | 60mm |
| 070 | 70mm |
| 080 | 80mm |
| 090 | 90mm |
| 100 | 100mm |
| 110 | 110mm |
| 120 | 120mm |
| 130 | 130mm |
| 140 | 140mm |
| 150 | 150mm |

NTC Thermistor for Temperature Sensor/Lead Type

(Part Number)

| | | | | | | | | | |
|-----|---|----|----|-----|---|---|---|---|-----|
| NXR | T | 15 | XH | 103 | F | A | 1 | B | 040 |
| ① | ② | ③ | ④ | ⑤ | ⑥ | ⑦ | ⑧ | ⑨ | ⑩ |

① Product ID

| Product ID | |
|------------|---------------------------------|
| NXR | NTC Thermistor Sensor/Lead Type |

② Individual Specifications

| Code | Individual Specifications |
|------|---------------------------|
| T | Commercial Type |

③ Chip Dimensions

| Code | Dimensions (L x T) |
|------|--------------------|
| 15 | 1.00 x 0.50mm |

④ Temperature Characteristics

| Code | Temperature Characteristics |
|------|-------------------------------|
| XH | Nominal B-Constant 3350–3399K |
| XM | Nominal B-Constant 3500–3549K |
| XV | Nominal B-Constant 3900–3949K |
| WB | Nominal B-Constant 4050–4099K |
| WF | Nominal B-Constant 4250–4299K |

⑤ Resistance

Expressed by three figures. The unit is (Ω). The first and second figures are significant digits, and the third figure expresses the number of zeros that follow the two figures.

Ex.

| Code | Resistance |
|------|------------|
| 202 | 2.0kΩ |
| 103 | 10kΩ |
| 104 | 100kΩ |

⑥ Resistance Tolerance

| Code | Resistance Tolerance |
|------|----------------------|
| F | ±1% |
| E | ±3% |
| J | ±5% |

⑦ Lead Wire Type

| Code | Lead Wire Type |
|------|--|
| A | Lead Type: ø0.4mm Copper-clad Fe Wire, Tinned Lead Insulation Type: ø0.46mm Cu Wire with Coat |

⑧ Shape of the Lead Wire

| Code | Shape of the Lead Wire |
|------|--------------------------------------|
| 1 | Lead Spacing 2.5mm |
| 3 | Lead Spacing 5.0mm |
| 5 | Lead Spacing 2.5mm (Insulation Type) |

⑨ Packaging

| Code | Packaging |
|------|------------------|
| A | Ammo Pack Taping |
| B | Bulk |

⑩ Dimensions (Full Length)

| Code | Lead Type | Lead Insulation Type |
|------|--------------------|----------------------|
| 010 | 10mm | – |
| 020 | 20mm | – |
| 025 | – | 25mm |
| 030 | 30mm | 30mm |
| 035 | – | 35mm |
| 040 | 40mm | 40mm |
| 045 | – | 45mm |
| 050 | 50mm | 50mm |
| 016 | 16mm (Taping Type) | – |

Basic Characteristics

Basic Characteristics

1. Zero-power Resistance of Thermistor: R

$$R = R_0 \exp B (1/T - 1/T_0) \dots\dots\dots (1)$$

R: Resistance in ambient temperature T (K)
 (K: absolute temperature)

R₀: Resistance in ambient temperature T₀ (K)

B: B-Constant of Thermistor

2. B-Constant

as (1) formula

$$B = \ln (R/R_0) / (1/T - 1/T_0)$$

3. Thermal Dissipation Constant

When electric power P (mW) is spent in ambient temperature T₁ and thermistor temperature rises T₂, the formula is as follows

$$P = C (T_2 - T_1)$$

C: Thermal dissipation constant (mW/°C)

Thermal dissipation constant is varied with dimensions, measurement conditions, etc.



4. Thermal Time Constant

Period in which the thermistor's temperature will change 63.2% of its temperature difference from ambient temperature T₀ (°C) to T₁ (°C).



Performance

| Item | Condition |
|------------------------------|--|
| Resistance | Measured by zero-power in specified ambient temperature. |
| B-Constant | Calculated between two specified ambient temperatures by the next formula. T and T ₀ is absolute temperature (K). $B = \frac{\ln (R/R_0)}{1/T - 1/T_0}$ |
| Thermal Dissipation Constant | Shows necessary electric power that Thermistor's temperature rises 1°C by self-heating. It is calculated by the next formula (mW/°C). $C = \frac{P}{T - T_0}$ |
| Maximum Operating Current | It is possible to keep the thermistor's temperature rising max. 0.1°C. |

Please inquire about test conditions and ratings.

NTC Thermistors

Temperature Sensor and Compensation 0201 (0603) Size

Chip NTC Thermistors' Ni barrier termination provides excellent solderability and their unique construction offers high stability in the application's environment.

Features

1. Excellent solderability and high stability in the application's environment
2. Excellent long-term stability
3. High accuracy in resistance and B-Constant
4. Reflow soldering possible
5. NCP series are recognized by UL/cUL.
 (UL1434, File No.E137188)



Detailed are accessible from the following URL.
<https://www.murata.com/en-global/products/thermistor/ntc/ncp>

Applications

1. Temperature compensation for transistors, ICs, and crystal oscillators in mobile communications
2. Temperature sensor for rechargeable batteries

| Part Number | Resistance (25°C) (ohm) | B-Constant (25-50°C) (K) | B-Constant (25-80°C) (Reference Value) (K) | B-Constant (25-85°C) (Reference Value) (K) | B-Constant (25-100°C) (Reference Value) (K) | Maximum Operating Current (25°C) (mA) | Maximum Voltage (V) | Typical Dissipation Constant (25°C) (mW/°C) |
|-----------------|-------------------------|--------------------------|--|--|---|---------------------------------------|---------------------|---|
| NCP03XM102□05RL | 1.0k | 3500 ±1% | 3539 | 3545 | 3560 | 0.316 | 5 | 1 |
| NCP03XM152□05RL | 1.5k | 3500 ±1% | 3539 | 3545 | 3560 | 0.258 | 5 | 1 |
| NCP03XM222□05RL | 2.2k | 3500 ±1% | 3539 | 3545 | 3560 | 0.213 | 5 | 1 |
| NCP03XM332□05RL | 3.3k | 3500 ±1% | 3539 | 3545 | 3560 | 0.174 | 5 | 1 |
| NCP03XM472□05RL | 4.7k | 3500 ±1% | 3539 | 3545 | 3560 | 0.146 | 5 | 1 |
| NCP03XH682□05RL | 6.8k | 3380 ±1% | 3428 | 3434 | 3455 | 0.121 | 5 | 1 |
| NCP03XH103F05RL | 10k ±1% | 3380 ±1% | 3428 | 3434 | 3455 | 0.100 | 5 | 1 |
| NCP03XH103□05RL | 10k | 3380 ±1% | 3428 | 3434 | 3455 | 0.100 | 5 | 1 |
| NCP03XV103□05RL | 10k | 3900 ±1% | 3930 | 3934 | 3944 | 0.100 | 5 | 1 |
| NCP03XH153□05RL | 15k | 3380 ±1% | 3428 | 3434 | 3455 | 0.082 | 5 | 1 |
| NCP03XH223F05RL | 22k ±1% | 3380 ±1% | 3428 | 3434 | 3455 | 0.067 | 5 | 1 |
| NCP03XH223□05RL | 22k | 3380 ±1% | 3428 | 3434 | 3455 | 0.067 | 5 | 1 |
| NCP03WF333□05RL | 33k | 4250 ±1% | 4303 | 4311 | 4334 | 0.055 | 5 | 1 |
| NCP03WB473F05RL | 47k ±1% | 4050 ±1% | 4101 | 4108 | 4131 | 0.046 | 5 | 1 |
| NCP03WB473□05RL | 47k | 4050 ±3% | 4101 | 4108 | 4131 | 0.046 | 5 | 1 |
| NCP03WL473□05RL | 47k | 4485 ±1% | 4537 | 4543 | 4557 | 0.046 | 5 | 1 |
| NCP03WF683F05RL | 68k ±1% | 4250 ±1% | 4303 | 4311 | 4334 | 0.038 | 5 | 1 |
| NCP03WF683□05RL | 68k | 4250 ±1% | 4303 | 4311 | 4334 | 0.038 | 5 | 1 |
| NCP03WL683□05RL | 68k | 4485 ±1% | 4537 | 4543 | 4557 | 0.038 | 5 | 1 |
| NCP03WF104F05RL | 100k ±1% | 4250 ±1% | 4303 | 4311 | 4334 | 0.032 | 5 | 1 |
| NCP03WF104□05RL | 100k | 4250 ±1% | 4303 | 4311 | 4334 | 0.032 | 5 | 1 |
| NCP03WL104□05RL | 100k | 4485 ±1% | 4537 | 4543 | 4557 | 0.032 | 5 | 1 |
| NCP03WL154□05RL | 150k | 4485 ±1% | 4537 | 4543 | 4557 | 0.026 | 5 | 1 |
| NCP03WL224□05RL | 220k | 4485 ±1% | 4537 | 4543 | 4557 | 0.021 | 5 | 1 |
| NCP03WF474F05RL | 470k ±1% | 4250 ±1% | 4303 | 4311 | 4334 | 0.015 | 5 | 1 |

□ is filled with resistance tolerance codes (E: ±3%, J: ±5%).
 Operating Temperature Range: -40°C to +125°C

NTC Thermistors

Temperature Sensor and Compensation 0402 (1005) Size/NCP Series

Chip NTC Thermistors' Ni barrier termination provides excellent solderability and their unique construction offers high stability in the application's environment.

Features

1. Excellent solderability and high stability in the application's environment
2. Excellent long-term stability
3. High accuracy in resistance and B-Constant
4. Reflow soldering possible
5. Same B-constant in the same resistance in the two sizes (0603 size/0402 size)
Downsize is easy for design.
6. NCP series are recognized by UL/cUL.
(UL1434, File No.E137188)

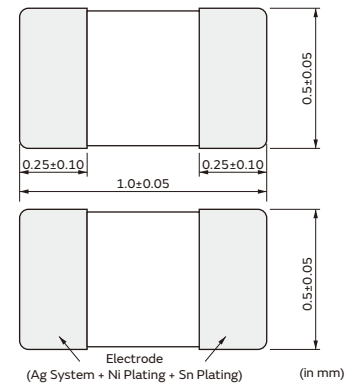

Detailed are accessible from the following URL.
<https://www.murata.com/en-global/products/thermistor/ntc/ncp>

Applications

1. Temperature compensation for transistors, ICs, and crystal oscillators in mobile communications
2. Temperature sensor for rechargeable batteries
3. Temperature compensation of LCD
4. Temperature compensation in general use of electric circuits

| Part Number | Resistance (25°C) (ohm) | B-Constant (25-50°C) (K) | B-Constant (25-80°C) (Reference Value) (K) | B-Constant (25-85°C) (Reference Value) (K) | B-Constant (25-100°C) (Reference Value) (K) | Maximum Operating Current (25°C) (mA) | Maximum Voltage (V) | Typical Dissipation Constant (25°C) (mW/°C) |
|-----------------|-------------------------|--------------------------|--|--|---|---------------------------------------|---------------------|---|
| NCP15XM221□03RC | 220 | 3500 ±3% | 3539 | 3545 | 3560 | 0.674 | 5 | 1 |
| NCP15XM331□03RC | 330 | 3500 ±3% | 3539 | 3545 | 3560 | 0.550 | 5 | 1 |
| NCP15XQ471□03RC | 470 | 3650 ±2% | 3688 | 3693 | 3706 | 0.609 | 5 | 1 |
| NCP15XQ681□03RC | 680 | 3650 ±3% | 3688 | 3693 | 3706 | 0.383 | 5 | 1 |
| NCP15XQ102□03RC | 1.0k | 3650 ±2% | 3688 | 3693 | 3706 | 0.316 | 5 | 1 |
| NCP15XW152□03RC | 1.5k | 3950 ±3% | 3982 | 3987 | 3998 | 0.258 | 5 | 1 |
| NCP15XW222□03RC | 2.2k | 3950 ±3% | 3982 | 3987 | 3998 | 0.213 | 5 | 1 |
| NCP15XW332□03RC | 3.3k | 3950 ±3% | 3982 | 3987 | 3998 | 0.174 | 5 | 1 |
| NCP15XM472□03RC | 4.7k | 3500 ±2% | 3539 | 3545 | 3560 | 0.146 | 5 | 1 |
| NCP15XW472□03RC | 4.7k | 3950 ±3% | 3982 | 3987 | 3998 | 0.146 | 5 | 1 |
| NCP15XW682□03RC | 6.8k | 3950 ±3% | 3982 | 3987 | 3998 | 0.121 | 5 | 1 |
| NCP15XH103D03RC | 10k ±0.5% | 3380 ±0.7% | 3428 | 3434 | 3455 | 0.100 | 5 | 1 |
| NCP15XH103F03RC | 10k ±1% | 3380 ±1% | 3428 | 3434 | 3455 | 0.100 | 5 | 1 |
| NCP15XH103□03RC | 10k | 3380 ±1% | 3428 | 3434 | 3455 | 0.100 | 5 | 1 |
| NCP15XV103□03RC | 10k | 3900 ±3% | 3930 | 3934 | 3944 | 0.100 | 5 | 1 |
| NCP15XW153□03RC | 15k | 3950 ±3% | 3982 | 3987 | 3998 | 0.082 | 5 | 1 |
| NCP15XW223□03RC | 22k | 3950 ±3% | 3982 | 3987 | 3998 | 0.067 | 5 | 1 |
| NCP15WL223□03RC | 22k | 4485 ±1% | 4537 | 4543 | 4557 | 0.067 | 5 | 1 |
| NCP15WB333□03RC | 33k | 4050 ±3% | 4101 | 4108 | 4131 | 0.055 | 5 | 1 |
| NCP15WL333□03RC | 33k | 4485 ±1% | 4537 | 4543 | 4557 | 0.055 | 5 | 1 |
| NCP15WB473D03RC | 47k ±0.5% | 4050 ±0.5% | 4101 | 4108 | 4131 | 0.046 | 5 | 1 |
| NCP15WB473F03RC | 47k ±1% | 4050 ±1% | 4101 | 4108 | 4131 | 0.046 | 5 | 1 |
| NCP15WB473□03RC | 47k | 4050 ±1% | 4101 | 4108 | 4131 | 0.046 | 5 | 1 |
| NCP15WL473□03RC | 47k | 4485 ±1% | 4537 | 4543 | 4557 | 0.046 | 5 | 1 |

□ is filled with resistance tolerance codes (E: ±3%, J: ±5%).
 Operating Temperature Range: -40°C to +125°C

Continued on the following page. ↗

Continued from the preceding page. ↘

| Part Number | Resistance (25°C) (ohm) | B-Constant (25-50°C) (K) | B-Constant (25-80°C) (Reference Value) (K) | B-Constant (25-85°C) (Reference Value) (K) | B-Constant (25-100°C) (Reference Value) (K) | Maximum Operating Current (25°C) (mA) | Maximum Voltage (V) | Typical Dissipation Constant (25°C) (mW/°C) |
|------------------------|-------------------------|--------------------------|--|--|---|---------------------------------------|---------------------|---|
| NCP15WD683□03RC | 68k | 4150 ±3% | 4201 | 4209 | 4232 | 0.038 | 5 | 1 |
| NCP15WL683□03RC | 68k | 4485 ±1% | 4537 | 4543 | 4557 | 0.038 | 5 | 1 |
| NCP15WF104D03RC | 100k ±0.5% | 4250 ±0.5% | 4303 | 4311 | 4334 | 0.032 | 5 | 1 |
| NCP15WF104F03RC | 100k ±1% | 4250 ±1% | 4303 | 4311 | 4334 | 0.032 | 5 | 1 |
| NCP15WF104□03RC | 100k | 4250 ±1% | 4303 | 4311 | 4334 | 0.032 | 5 | 1 |
| NCP15WL104□03RC | 100k | 4485 ±1% | 4537 | 4543 | 4557 | 0.032 | 5 | 1 |
| NCP15WL154□03RC | 150k | 4485 ±1% | 4537 | 4543 | 4557 | 0.026 | 5 | 1 |
| NCP15WM154□03RC | 150k | 4500 ±3% | 4571 | 4582 | 4614 | 0.026 | 5 | 1 |
| NCP15WM224□03RC | 220k | 4500 ±3% | 4571 | 4582 | 4614 | 0.021 | 5 | 1 |
| NCP15WM474□03RC | 470k | 4500 ±3% | 4571 | 4582 | 4614 | 0.015 | 5 | 1 |

□ is filled with resistance tolerance codes (E: ±3%, J: ±5%).
 Operating Temperature Range: -40°C to +125°C

2

NTC Thermistors

Temperature Sensor and Compensation 0402 (1005) Size/NCU Series

Chip NTC Thermistors have Ni barrier termination, provide excellent solderability and offer high stability in environment due to unique inner construction.

This is new series, available market where request the high reliability for wide temperature sensing and compensation.



Features

1. Excellent solderability and high stability in the application's environment
2. Excellent long-term stability
3. High accuracy in resistance and B-Constant
4. Reflow soldering possible
5. Same B-constant in the same resistance in the two sizes (0603 size/0402 size)
Downsize is easy for design.
6. NCU series are recognized by UL/cUL.
(UL1434, File No.E137188)

Detailed are accessible from the following URL.
<https://www.murata.com/en-global/products/thermistor/ntc/ncu>

Applications

1. Temperature compensation for transistors, ICs, and crystal oscillators in mobile communications
2. Temperature sensor for rechargeable batteries
3. Temperature compensation of LCD
4. Temperature compensation in general use of electric circuits

| Part Number | Resistance (25°C) (ohm) | B-Constant (25-50°C) (K) | B-Constant (25-80°C) (Reference Value) (K) | B-Constant (25-85°C) (Reference Value) (K) | B-Constant (25-100°C) (Reference Value) (K) | Maximum Operating Current (25°C) (mA) | Maximum Voltage (V) | Typical Dissipation Constant (25°C) (mW/°C) |
|-----------------|-------------------------|--------------------------|--|--|---|---------------------------------------|---------------------|---|
| NCU15XH103D60RC | 10k ±0.5% | 3380 ±0.7% | 3428 | 3434 | 3455 | 0.100 | 5 | 1 |
| NCU15XH103F60RC | 10k ±1% | 3380 ±1% | 3428 | 3434 | 3455 | 0.100 | 5 | 1 |
| NCU15XH103□60RC | 10k | 3380 ±1% | 3428 | 3434 | 3455 | 0.100 | 5 | 1 |
| NCU15WB473D60RC | 47k ±0.5% | 4050 ±0.5% | 4101 | 4108 | 4131 | 0.046 | 5 | 1 |
| NCU15WB473F60RC | 47k ±1% | 4050 ±1% | 4101 | 4108 | 4131 | 0.046 | 5 | 1 |
| NCU15WB473□60RC | 47k | 4050 ±1% | 4101 | 4108 | 4131 | 0.046 | 5 | 1 |
| NCU15WF104D60RC | 100k ±0.5% | 4250 ±0.5% | 4303 | 4311 | 4334 | 0.032 | 5 | 1 |
| NCU15WF104F60RC | 100k ±1% | 4250 ±1% | 4303 | 4311 | 4334 | 0.032 | 5 | 1 |
| NCU15WF104□60RC | 100k | 4250 ±1% | 4303 | 4311 | 4334 | 0.032 | 5 | 1 |

□ is filled with resistance tolerance codes (E: ±3%, J: ±5%).

Operating Temperature Range: -40°C to +125°C

If there is any additionally electrical characteristics, please contact from close sales office or website.

NTC Thermistors

Temperature Sensor and Compensation 0603 (1608) Size/NCP Series

Chip NTC Thermistors' Ni barrier termination provides excellent solderability and their unique construction offers high stability in the application's environment.

Features

1. Excellent solderability and high stability in the application's environment
2. Excellent long-term stability
3. High accuracy in resistance and B-constant
4. Flow/Reflow soldering possible
5. Same B-Constant in the same resistance in the two sizes (0603 size/0402 size)
Downsize is easy for design.
6. NCP series are recognized by UL/cUL.
(UL1434, File No.E137188)

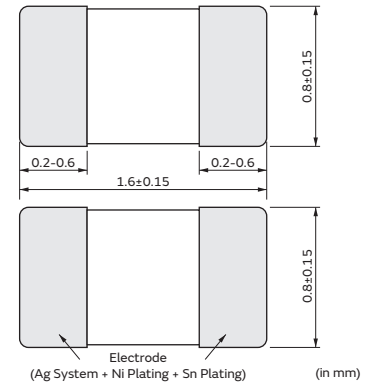

Detailed are accessible from the following URL.
<https://www.murata.com/en-global/products/thermistor/ntc/ncp>

Applications

1. Temperature compensation for transistors, ICs, and crystal oscillators in mobile communications
2. Temperature sensor for rechargeable batteries
3. Temperature compensation of LCD
4. Temperature compensation in general use of electric circuits

| Part Number | Resistance (25°C) (ohm) | B-Constant (25-50°C) (K) | B-Constant (25-80°C) (Reference Value) (K) | B-Constant (25-85°C) (Reference Value) (K) | B-Constant (25-100°C) (Reference Value) (K) | Maximum Operating Current (25°C) (mA) | Maximum Voltage (V) | Typical Dissipation Constant (25°C) (mW/°C) |
|-----------------|-------------------------|--------------------------|--|--|---|---------------------------------------|---------------------|---|
| NCP18XM221□03RB | 220 | 3500 ±3% | 3539 | 3545 | 3560 | 0.674 | 5 | 1 |
| NCP18XM331□03RB | 330 | 3500 ±3% | 3539 | 3545 | 3560 | 0.550 | 5 | 1 |
| NCP18XQ471□03RB | 470 | 3650 ±2% | 3688 | 3693 | 3706 | 0.609 | 5 | 1 |
| NCP18XQ681□03RB | 680 | 3650 ±3% | 3688 | 3693 | 3706 | 0.383 | 5 | 1 |
| NCP18XQ102□03RB | 1.0k | 3650 ±2% | 3688 | 3693 | 3706 | 0.316 | 5 | 1 |
| NCP18XW152□03RB | 1.5k | 3950 ±3% | 3982 | 3987 | 3998 | 0.258 | 5 | 1 |
| NCP18XW222□03RB | 2.2k | 3950 ±3% | 3982 | 3987 | 3998 | 0.213 | 5 | 1 |
| NCP18XW332□03RB | 3.3k | 3950 ±3% | 3982 | 3987 | 3998 | 0.174 | 5 | 1 |
| NCP18XM472□03RB | 4.7k | 3500 ±2% | 3539 | 3545 | 3560 | 0.146 | 5 | 1 |
| NCP18XW472□03RB | 4.7k | 3950 ±3% | 3982 | 3987 | 3998 | 0.146 | 5 | 1 |
| NCP18XW682□03RB | 6.8k | 3950 ±3% | 3982 | 3987 | 3998 | 0.121 | 5 | 1 |
| NCP18XH103D03RB | 10k ±0.5% | 3380 ±0.7% | 3428 | 3434 | 3455 | 0.100 | 5 | 1 |
| NCP18XH103F03RB | 10k ±1% | 3380 ±1% | 3428 | 3434 | 3455 | 0.100 | 5 | 1 |
| NCP18XH103□03RB | 10k | 3380 ±1% | 3428 | 3434 | 3455 | 0.100 | 5 | 1 |
| NCP18XV103□03RB | 10k | 3900 ±3% | 3930 | 3934 | 3944 | 0.100 | 5 | 1 |
| NCP18XW153□03RB | 15k | 3950 ±3% | 3982 | 3987 | 3998 | 0.082 | 5 | 1 |
| NCP18XW223□03RB | 22k | 3950 ±3% | 3982 | 3987 | 3998 | 0.067 | 5 | 1 |
| NCP18WB333□03RB | 33k | 4050 ±3% | 4101 | 4108 | 4131 | 0.055 | 5 | 1 |
| NCP18WB473D03RB | 47k ±0.5% | 4050 ±0.5% | 4101 | 4108 | 4131 | 0.046 | 5 | 1 |
| NCP18WB473F10RB | 47k ±1% | 4050 ±1.5% | 4101 | 4108 | 4131 | 0.046 | 5 | 1 |
| NCP18WB473□03RB | 47k | 4050 ±1% | 4101 | 4108 | 4131 | 0.046 | 5 | 1 |
| NCP18WD683□03RB | 68k | 4150 ±3% | 4201 | 4209 | 4232 | 0.038 | 5 | 1 |
| NCP18WF104D03RB | 100k ±0.5% | 4200 ±0.5% | 4303 | 4311 | 4334 | 0.032 | 5 | 1 |

□ is filled with resistance tolerance codes (E: ±3%, J: ±5%).
 Operating Temperature Range: -40°C to +125°C

Continued on the following page. ↗

Continued from the preceding page. ↘

| Part Number | Resistance (25°C) (ohm) | B-Constant (25-50°C) (K) | B-Constant (25-80°C) (Reference Value) (K) | B-Constant (25-85°C) (Reference Value) (K) | B-Constant (25-100°C) (Reference Value) (K) | Maximum Operating Current (25°C) (mA) | Maximum Voltage (V) | Typical Dissipation Constant (25°C) (mW/°C) |
|------------------------|-------------------------------|--------------------------------|--|--|---|---|---------------------------|---|
| NCP18WF104F12RB | 100k ±1% | 4200 ±1% | 4303 | 4311 | 4334 | 0.032 | 5 | 1 |
| NCP18WF104□03RB | 100k | 4250 ±2% | 4303 | 4311 | 4334 | 0.032 | 5 | 1 |
| NCP18WM154□03RB | 150k | 4500 ±3% | 4571 | 4582 | 4614 | 0.026 | 5 | 1 |
| NCP18WM224□03RB | 220k | 4500 ±3% | 4571 | 4582 | 4614 | 0.021 | 5 | 1 |
| NCP18WM474□03RB | 470k | 4500 ±3% | 4571 | 4582 | 4614 | 0.015 | 5 | 1 |

□ is filled with resistance tolerance codes (E: ±3%, J: ±5%).

Operating Temperature Range: -40°C to +125°C

NTC Thermistors

Temperature Sensor and Compensation 0603 (1608) Size/NCU Series

Chip NTC Thermistors have Ni barrier termination, provide excellent solderability and offer high stability in environment due to unique inner construction.

This is new series, available market where request the high reliability for wide temperature sensing and compensation.

Features

1. Excellent solderability and high stability in the application's environment
2. Excellent long-term stability
3. High accuracy in resistance and B-constant
4. Flow/Reflow soldering possible
5. Same B-Constant in the same resistance in the two sizes (0603 size/0402 size)
Downsize is easy for design.
6. NCU series are recognized by UL/cUL.
(UL1434, File No.E137188)



Detailed are accessible from the following URL.
<https://www.murata.com/en-global/products/thermistor/ntc/ncu>

Applications

1. Temperature compensation for transistors, ICs, and crystal oscillators in mobile communications
2. Temperature sensor for rechargeable batteries
3. Temperature compensation of LCD
4. Temperature compensation in general use of electric circuits

| Part Number | Resistance (25°C) (ohm) | B-Constant (25-50°C) (K) | B-Constant (25-80°C) (Reference Value) (K) | B-Constant (25-85°C) (Reference Value) (K) | B-Constant (25-100°C) (Reference Value) (K) | Maximum Operating Current (25°C) (mA) | Maximum Voltage (V) | Typical Dissipation Constant (25°C) (mW/°C) |
|-----------------|-------------------------|--------------------------|--|--|---|---------------------------------------|---------------------|---|
| NCU18XH103D60RB | 10k ±0.5% | 3380 ±0.7% | 3428 | 3434 | 3455 | 0.100 | 5 | 1 |
| NCU18XH103F60RB | 10k ±1% | 3380 ±1% | 3428 | 3434 | 3455 | 0.100 | 5 | 1 |
| NCU18XH103□60RB | 10k | 3380 ±1% | 3428 | 3434 | 3455 | 0.100 | 5 | 1 |
| NCU18WB473D60RB | 47k ±0.5% | 4050 ±0.5% | 4101 | 4108 | 4131 | 0.046 | 5 | 1 |
| NCU18WB473F60RB | 47k ±1% | 4050 ±1% | 4101 | 4108 | 4131 | 0.046 | 5 | 1 |
| NCU18WB473□60RB | 47k | 4050 ±1% | 4101 | 4108 | 4131 | 0.046 | 5 | 1 |
| NCU18WF104D60RB | 100k ±0.5% | 4250 ±0.5% | 4303 | 4311 | 4334 | 0.032 | 5 | 1 |
| NCU18WF104F60RB | 100k ±1% | 4250 ±1% | 4303 | 4311 | 4334 | 0.032 | 5 | 1 |
| NCU18WF104□60RB | 100k | 4250 ±2% | 4303 | 4311 | 4334 | 0.032 | 5 | 1 |
| NCU18WM154□60RB | 150k | 4500 ±3% | 4571 | 4582 | 4614 | 0.026 | 5 | 1 |
| NCU18WM224□60RB | 220k | 4500 ±3% | 4571 | 4582 | 4614 | 0.021 | 5 | 1 |
| NCU18WM474□60RB | 470k | 4500 ±3% | 4571 | 4582 | 4614 | 0.015 | 5 | 1 |

□ is filled with resistance tolerance codes (E: ±3%, J: ±5%).

Operating Temperature Range: -40°C to +125°C

If there is any additionally electrical characteristics, please contact from close sales office or website.

Temperature Sensor and Compensation Chip Type Standard Land Pattern Dimensions

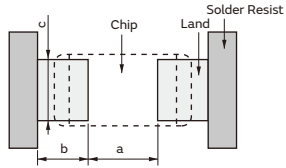

| Part Number | Soldering Methods | Dimensions (mm) | | | |
|--------------|-------------------|-----------------|---------|---------|---------|
| | | Chip (LxW) | a | b | c |
| NCP03 | Reflow Soldering | 0.6x0.3 | 0.25 | 0.3 | 0.3 |
| NCP15 | Reflow Soldering | 1.0x0.5 | 0.4 | 0.4-0.5 | 0.5 |
| NCU15 | Reflow Soldering | 1.0x0.5 | 0.6 | 0.4-0.5 | 0.5 |
| NCP18 | Flow Soldering | 1.6x0.8 | 0.6-1.0 | 0.8-0.9 | 0.6-0.8 |
| | Reflow Soldering | | 0.6-0.8 | 0.6-0.7 | 0.6-0.8 |
| NCU18 | Flow Soldering | 1.6x0.8 | 0.6-1.2 | 0.8-0.9 | 0.6-0.8 |
| | Reflow Soldering | | 0.6-1.2 | 0.6-0.7 | 0.6-0.8 |

Temperature Sensor and Compensation Chip Type Temperature Characteristics (Center Value)

| Part Number | NCP□□XM221 | NCP□□XM331 | NCP□□XQ471 | NCP□□XQ681 | NCP□□XM102 | NCP□□XQ102 | NCP□□XM152 | NCP□□XW152 |
|-------------|----------------|----------------|----------------|----------------|-----------------|-----------------|-----------------|-----------------|
| Resistance | 220Ω | 330Ω | 470Ω | 680Ω | 1.0kΩ | 1.0kΩ | 1.5kΩ | 1.5kΩ |
| B-Constant | 3500K | 3500K | 3650K | 3650K | 3500K | 3650K | 3500K | 3950K |
| Temp. (°C) | Resistance (Ω) | Resistance (Ω) | Resistance (Ω) | Resistance (Ω) | Resistance (kΩ) | Resistance (kΩ) | Resistance (kΩ) | Resistance (kΩ) |
| -40 | 4947.904 | 7421.856 | 11822.473 | 17104.854 | 21.266 | 25.154 | 31.899 | 51.791 |
| -35 | 3703.755 | 5555.632 | 8767.745 | 12685.248 | 16.150 | 18.655 | 24.225 | 37.172 |
| -30 | 2798.873 | 4198.309 | 6570.224 | 9505.855 | 12.347 | 13.979 | 18.520 | 27.005 |
| -25 | 2135.887 | 3203.831 | 4971.784 | 7193.219 | 9.503 | 10.578 | 14.255 | 19.843 |
| -20 | 1645.037 | 2467.555 | 3796.933 | 5493.436 | 7.365 | 8.079 | 11.047 | 14.728 |
| -15 | 1278.034 | 1917.051 | 2923.400 | 4229.599 | 5.747 | 6.220 | 8.621 | 11.044 |
| -10 | 1000.620 | 1500.930 | 2269.599 | 3283.675 | 4.516 | 4.829 | 6.773 | 8.362 |
| -5 | 789.612 | 1184.418 | 1775.225 | 2568.411 | 3.572 | 3.777 | 5.358 | 6.389 |
| 0 | 627.752 | 941.628 | 1399.050 | 2024.158 | 2.844 | 2.977 | 4.266 | 4.922 |
| 5 | 502.474 | 753.711 | 1110.220 | 1606.275 | 2.280 | 2.362 | 3.419 | 3.825 |
| 10 | 405.010 | 607.514 | 887.257 | 1283.691 | 1.839 | 1.888 | 2.758 | 2.994 |
| 15 | 328.480 | 492.720 | 713.463 | 1032.245 | 1.492 | 1.518 | 2.238 | 2.361 |
| 20 | 268.044 | 402.066 | 577.375 | 835.351 | 1.218 | 1.229 | 1.827 | 1.876 |
| 25 | 220.000 | 330.000 | 470.000 | 680.000 | 1.000 | 1.000 | 1.500 | 1.500 |
| 30 | 181.576 | 272.365 | 384.800 | 556.733 | 0.825 | 0.819 | 1.238 | 1.207 |
| 35 | 150.668 | 226.002 | 316.757 | 458.287 | 0.685 | 0.674 | 1.027 | 0.978 |
| 40 | 125.681 | 188.521 | 262.177 | 379.320 | 0.571 | 0.558 | 0.857 | 0.797 |
| 45 | 105.336 | 158.004 | 218.069 | 315.504 | 0.479 | 0.464 | 0.718 | 0.653 |
| 50 | 88.717 | 133.076 | 182.297 | 263.749 | 0.403 | 0.388 | 0.605 | 0.538 |
| 55 | 75.059 | 112.588 | 153.150 | 221.579 | 0.341 | 0.326 | 0.512 | 0.446 |
| 60 | 63.777 | 95.666 | 129.249 | 186.998 | 0.290 | 0.275 | 0.435 | 0.371 |
| 65 | 54.415 | 81.622 | 109.551 | 158.499 | 0.247 | 0.233 | 0.371 | 0.317 |
| 70 | 46.631 | 69.946 | 93.281 | 134.960 | 0.212 | 0.199 | 0.318 | 0.261 |
| 75 | 40.115 | 60.172 | 79.750 | 115.383 | 0.182 | 0.170 | 0.274 | 0.221 |
| 80 | 34.637 | 51.955 | 68.446 | 99.029 | 0.157 | 0.146 | 0.236 | 0.187 |
| 85 | 30.013 | 45.019 | 58.996 | 85.356 | 0.136 | 0.126 | 0.205 | 0.160 |
| 90 | 26.110 | 39.165 | 51.036 | 73.839 | 0.119 | 0.109 | 0.178 | 0.137 |
| 95 | 22.790 | 34.186 | 44.332 | 64.140 | 0.104 | 0.094 | 0.155 | 0.117 |
| 100 | 19.957 | 29.935 | 38.640 | 55.905 | 0.091 | 0.082 | 0.136 | 0.101 |
| 105 | 17.541 | 26.312 | 33.790 | 48.888 | 0.080 | 0.072 | 0.120 | 0.088 |
| 110 | 15.453 | 23.180 | 29.664 | 42.918 | 0.070 | 0.063 | 0.105 | 0.076 |
| 115 | 13.663 | 20.494 | 26.123 | 37.795 | 0.062 | 0.056 | 0.093 | 0.067 |
| 120 | 12.114 | 18.171 | 23.091 | 33.409 | 0.055 | 0.049 | 0.083 | 0.058 |
| 125 | 10.778 | 16.168 | 20.472 | 29.618 | 0.049 | 0.044 | 0.074 | 0.051 |

| Part Number | NCP□□XM222 | NCP□□XW222 | NCP□□XM332 | NCP□□XW332 | NCP□□XM472 | NCP□□XW472 | NCP□□XH682 | NCP□□XW682 |
|-------------|-----------------|-----------------|-----------------|-----------------|-----------------|-----------------|-----------------|-----------------|
| Resistance | 2.2kΩ | 2.2kΩ | 3.3kΩ | 3.3kΩ | 4.7kΩ | 4.7kΩ | 6.8kΩ | 6.8kΩ |
| B-Constant | 3500K | 3950K | 3500K | 3950K | 3500K | 3950K | 3380K | 3950K |
| Temp. (°C) | Resistance (kΩ) | Resistance (kΩ) | Resistance (kΩ) | Resistance (kΩ) | Resistance (kΩ) | Resistance (kΩ) | Resistance (kΩ) | Resistance (kΩ) |
| -40 | 46.786 | 75.961 | 70.179 | 113.941 | 105.705 | 162.279 | 133.043 | 234.787 |
| -35 | 35.530 | 54.520 | 53.295 | 81.779 | 79.126 | 116.474 | 100.756 | 168.515 |
| -30 | 27.162 | 39.607 | 40.743 | 59.411 | 59.794 | 84.615 | 77.076 | 122.422 |
| -25 | 20.907 | 29.103 | 31.360 | 43.654 | 45.630 | 62.173 | 59.540 | 89.953 |
| -20 | 16.203 | 21.601 | 24.304 | 32.401 | 35.144 | 46.147 | 46.401 | 66.766 |
| -15 | 12.644 | 16.198 | 18.966 | 24.297 | 27.303 | 34.604 | 36.482 | 50.066 |
| -10 | 9.934 | 12.264 | 14.901 | 18.396 | 21.377 | 26.200 | 28.904 | 37.906 |
| -5 | 7.858 | 9.370 | 11.787 | 14.055 | 16.869 | 20.018 | 23.047 | 28.963 |
| 0 | 6.257 | 7.219 | 9.386 | 10.829 | 13.411 | 15.423 | 18.509 | 22.313 |
| 5 | 5.015 | 5.609 | 7.523 | 8.414 | 10.735 | 11.984 | 14.974 | 17.338 |
| 10 | 4.045 | 4.391 | 6.067 | 6.586 | 8.653 | 9.380 | 12.189 | 13.571 |
| 15 | 3.283 | 3.463 | 4.924 | 5.195 | 7.018 | 7.399 | 9.978 | 10.705 |
| 20 | 2.680 | 2.751 | 4.019 | 4.126 | 5.726 | 5.877 | 8.215 | 8.503 |
| 25 | 2.200 | 2.200 | 3.300 | 3.300 | 4.700 | 4.700 | 6.800 | 6.800 |
| 30 | 1.816 | 1.771 | 2.724 | 2.656 | 3.879 | 3.783 | 5.654 | 5.474 |
| 35 | 1.507 | 1.434 | 2.260 | 2.152 | 3.219 | 3.064 | 4.725 | 4.434 |
| 40 | 1.257 | 1.169 | 1.885 | 1.753 | 2.685 | 2.497 | 3.967 | 3.613 |
| 45 | 1.053 | 0.958 | 1.580 | 1.437 | 2.250 | 2.046 | 3.344 | 2.961 |
| 50 | 0.887 | 0.789 | 1.331 | 1.184 | 1.895 | 1.686 | 2.829 | 2.440 |
| 55 | 0.751 | 0.654 | 1.126 | 0.981 | 1.604 | 1.397 | 2.404 | 2.022 |
| 60 | 0.638 | 0.545 | 0.957 | 0.817 | 1.363 | 1.164 | 2.050 | 1.683 |
| 65 | 0.544 | 0.456 | 0.816 | 0.684 | 1.163 | 0.974 | 1.759 | 1.409 |
| 70 | 0.466 | 0.383 | 0.700 | 0.575 | 0.996 | 0.819 | 1.515 | 1.185 |
| 75 | 0.401 | 0.324 | 0.602 | 0.486 | 0.857 | 0.692 | 1.309 | 1.001 |
| 80 | 0.346 | 0.275 | 0.520 | 0.412 | 0.740 | 0.587 | 1.135 | 0.849 |
| 85 | 0.300 | 0.234 | 0.450 | 0.351 | 0.641 | 0.500 | 0.988 | 0.724 |
| 90 | 0.261 | 0.200 | 0.392 | 0.301 | 0.558 | 0.428 | 0.862 | 0.620 |
| 95 | 0.228 | 0.172 | 0.342 | 0.258 | 0.487 | 0.368 | 0.755 | 0.532 |
| 100 | 0.200 | 0.149 | 0.299 | 0.223 | 0.426 | 0.318 | 0.662 | 0.459 |
| 105 | 0.175 | 0.129 | 0.263 | 0.193 | 0.375 | 0.275 | 0.583 | 0.398 |
| 110 | 0.155 | 0.112 | 0.232 | 0.168 | 0.330 | 0.239 | 0.515 | 0.346 |
| 115 | 0.137 | 0.098 | 0.205 | 0.146 | 0.292 | 0.208 | 0.457 | 0.302 |
| 120 | 0.121 | 0.085 | 0.182 | 0.128 | 0.259 | 0.182 | 0.406 | 0.264 |
| 125 | 0.108 | 0.075 | 0.162 | 0.113 | 0.230 | 0.160 | 0.361 | 0.232 |

Continued on the following page. ↗

Temperature Sensor and Compensation Chip Type Temperature Characteristics (Center Value)

Continued from the preceding page. ↘

| Part Number | NC□□XH103D | NC□□XH103 | NCP□□XV103 | NCP□□XH153 | NCP□□XW153 | NCP□□XH223 | NCP□□XW223 | NCP□□WL223 |
|-------------|-----------------|-----------------|-----------------|-----------------|-----------------|-----------------|-----------------|-----------------|
| Resistance | 10kΩ±0.5% | 10kΩ | 10kΩ | 15kΩ | 15kΩ | 22kΩ | 22kΩ | 22kΩ |
| B-Constant | 3380K | 3380K | 3900K | 3380K | 3950K | 3380K | 3950K | 4485K |
| Temp. (°C) | Resistance (kΩ) | Resistance (kΩ) | Resistance (kΩ) | Resistance (kΩ) | Resistance (kΩ) | Resistance (kΩ) | Resistance (kΩ) | Resistance (kΩ) |
| -40 | 197.390 | 195.652 | 328.996 | 293.478 | 517.912 | 430.434 | 759.605 | 1073.436 |
| -35 | 149.390 | 148.171 | 237.387 | 222.256 | 371.724 | 325.976 | 545.196 | 753.900 |
| -30 | 114.340 | 113.347 | 173.185 | 170.021 | 270.048 | 249.364 | 396.070 | 535.073 |
| -25 | 88.381 | 87.559 | 127.773 | 131.338 | 198.426 | 192.629 | 291.025 | 383.590 |
| -20 | 68.915 | 68.237 | 95.327 | 102.355 | 147.278 | 150.121 | 216.008 | 277.643 |
| -15 | 54.166 | 53.650 | 71.746 | 80.474 | 110.439 | 118.029 | 161.977 | 202.813 |
| -10 | 42.889 | 42.506 | 54.564 | 63.759 | 83.617 | 93.514 | 122.638 | 149.462 |
| -5 | 34.196 | 33.892 | 41.813 | 50.838 | 63.888 | 74.563 | 93.702 | 111.082 |
| 0 | 27.445 | 27.219 | 32.330 | 40.828 | 49.221 | 59.881 | 72.191 | 83.233 |
| 5 | 22.165 | 22.021 | 25.194 | 33.032 | 38.245 | 48.446 | 56.093 | 62.858 |
| 10 | 18.010 | 17.926 | 19.785 | 26.888 | 29.936 | 39.436 | 43.907 | 47.831 |
| 15 | 14.720 | 14.674 | 15.651 | 22.010 | 23.613 | 32.282 | 34.633 | 36.664 |
| 20 | 12.099 | 12.081 | 12.468 | 18.121 | 18.756 | 26.577 | 27.509 | 28.304 |
| 25 | 10.000 | 10.000 | 10.000 | 15.000 | 15.000 | 22.000 | 22.000 | 22.000 |
| 30 | 8.309 | 8.315 | 8.072 | 12.472 | 12.074 | 18.292 | 17.709 | 17.214 |
| 35 | 6.939 | 6.948 | 6.556 | 10.422 | 9.780 | 15.285 | 14.344 | 13.557 |
| 40 | 5.824 | 5.834 | 5.356 | 8.751 | 7.969 | 12.834 | 11.688 | 10.744 |
| 45 | 4.911 | 4.917 | 4.401 | 7.375 | 6.531 | 10.817 | 9.578 | 8.566 |
| 50 | 4.160 | 4.161 | 3.635 | 6.241 | 5.382 | 9.154 | 7.894 | 6.871 |
| 55 | 3.539 | 3.535 | 3.019 | 5.302 | 4.459 | 7.777 | 6.540 | 5.544 |
| 60 | 3.024 | 3.014 | 2.521 | 4.521 | 3.713 | 6.631 | 5.446 | 4.498 |
| 65 | 2.593 | 2.586 | 2.115 | 3.879 | 3.108 | 5.690 | 4.559 | 3.669 |
| 70 | 2.233 | 2.228 | 1.781 | 3.341 | 2.613 | 4.901 | 3.832 | 3.009 |
| 75 | 1.929 | 1.925 | 1.509 | 2.887 | 2.208 | 4.234 | 3.239 | 2.479 |
| 80 | 1.673 | 1.669 | 1.284 | 2.503 | 1.873 | 3.671 | 2.748 | 2.052 |
| 85 | 1.455 | 1.452 | 1.097 | 2.178 | 1.597 | 3.195 | 2.342 | 1.707 |
| 90 | 1.270 | 1.268 | 0.941 | 1.902 | 1.367 | 2.790 | 2.004 | 1.426 |
| 95 | 1.112 | 1.110 | 0.810 | 1.664 | 1.174 | 2.441 | 1.722 | 1.196 |
| 100 | 0.976 | 0.974 | 0.701 | 1.461 | 1.013 | 2.142 | 1.486 | 1.008 |
| 105 | 0.860 | 0.858 | 0.608 | 1.287 | 0.878 | 1.888 | 1.287 | 0.852 |
| 110 | 0.759 | 0.758 | 0.530 | 1.137 | 0.763 | 1.668 | 1.119 | 0.724 |
| 115 | 0.673 | 0.672 | 0.463 | 1.007 | 0.665 | 1.477 | 0.975 | 0.617 |
| 120 | 0.598 | 0.596 | 0.406 | 0.895 | 0.582 | 1.312 | 0.854 | 0.528 |
| 125 | 0.532 | 0.531 | 0.358 | 0.797 | 0.511 | 1.169 | 0.750 | 0.454 |

| Part Number | NCP□□WB333 | NCP□□WF333 | NCP□□WL333 | NC□□WB473D | NC□□WB473 | NCP□□WL473 | NCP□□WD683 | NCP□□WF683 |
|-------------|-----------------|-----------------|-----------------|-----------------|-----------------|-----------------|-----------------|-----------------|
| Resistance | 33kΩ | 33kΩ | 33kΩ | 47kΩ±0.5% | 47kΩ | 47kΩ | 68kΩ | 68kΩ |
| B-Constant | 4050K | 4250K | 4485K | 4050K | 4050K | 4485K | 4150K | 4250K |
| Temp. (°C) | Resistance (kΩ) | Resistance (kΩ) | Resistance (kΩ) | Resistance (kΩ) | Resistance (kΩ) | Resistance (kΩ) | Resistance (kΩ) | Resistance (kΩ) |
| -40 | 1227.263 | 1451.049 | 1610.154 | 1690.586 | 1747.920 | 2293.249 | 2735.359 | 2990.041 |
| -35 | 874.449 | 1019.238 | 1130.850 | 1215.318 | 1245.428 | 1610.605 | 1937.391 | 2100.247 |
| -30 | 630.851 | 725.084 | 802.609 | 882.908 | 898.485 | 1143.110 | 1389.345 | 1494.113 |
| -25 | 460.457 | 522.021 | 575.385 | 647.911 | 655.802 | 819.487 | 1008.014 | 1075.679 |
| -20 | 339.797 | 379.842 | 416.464 | 480.069 | 483.954 | 593.146 | 738.978 | 782.705 |
| -15 | 253.363 | 279.371 | 304.219 | 359.009 | 360.850 | 433.281 | 547.456 | 575.674 |
| -10 | 190.766 | 207.566 | 224.193 | 270.868 | 271.697 | 319.305 | 409.600 | 427.712 |
| -5 | 144.964 | 155.639 | 166.623 | 206.113 | 206.463 | 237.312 | 309.217 | 320.710 |
| 0 | 111.087 | 117.814 | 124.850 | 158.126 | 158.214 | 177.816 | 235.606 | 242.768 |
| 5 | 85.842 | 89.925 | 94.287 | 122.267 | 122.259 | 134.287 | 180.980 | 185.300 |
| 10 | 66.861 | 69.204 | 71.747 | 95.256 | 95.227 | 102.184 | 140.139 | 142.603 |
| 15 | 52.470 | 53.675 | 54.996 | 74.754 | 74.730 | 78.327 | 109.344 | 110.602 |
| 20 | 41.471 | 41.937 | 42.455 | 59.075 | 59.065 | 60.467 | 85.929 | 86.415 |
| 25 | 33.000 | 33.000 | 33.000 | 47.000 | 47.000 | 47.000 | 68.000 | 68.000 |
| 30 | 26.430 | 26.143 | 25.822 | 37.636 | 37.643 | 36.776 | 54.167 | 53.871 |
| 35 | 21.298 | 20.845 | 20.335 | 30.326 | 30.334 | 28.962 | 43.421 | 42.954 |
| 40 | 17.266 | 16.723 | 16.115 | 24.583 | 24.591 | 22.952 | 35.016 | 34.460 |
| 45 | 14.076 | 13.498 | 12.849 | 20.043 | 20.048 | 18.301 | 28.406 | 27.814 |
| 50 | 11.538 | 10.954 | 10.306 | 16.433 | 16.433 | 14.679 | 23.166 | 22.572 |
| 55 | 9.506 | 8.940 | 8.317 | 13.545 | 13.539 | 11.845 | 18.997 | 18.422 |
| 60 | 7.870 | 7.334 | 6.748 | 11.223 | 11.209 | 9.610 | 15.657 | 15.113 |
| 65 | 6.549 | 6.046 | 5.504 | 9.345 | 9.328 | 7.839 | 12.967 | 12.459 |
| 70 | 5.475 | 5.011 | 4.513 | 7.818 | 7.798 | 6.427 | 10.794 | 10.325 |
| 75 | 4.595 | 4.170 | 3.718 | 6.571 | 6.544 | 5.296 | 9.021 | 8.592 |
| 80 | 3.874 | 3.487 | 3.078 | 5.548 | 5.518 | 4.384 | 7.575 | 7.185 |
| 85 | 3.282 | 2.928 | 2.560 | 4.704 | 4.674 | 3.646 | 6.387 | 6.033 |
| 90 | 2.789 | 2.469 | 2.139 | 4.004 | 3.972 | 3.046 | 5.407 | 5.087 |
| 95 | 2.379 | 2.091 | 1.794 | 3.422 | 3.388 | 2.555 | 4.598 | 4.309 |
| 100 | 2.038 | 1.777 | 1.511 | 2.936 | 2.902 | 2.152 | 3.922 | 3.661 |
| 105 | 1.751 | 1.516 | 1.278 | 2.528 | 2.494 | 1.820 | 3.359 | 3.124 |
| 110 | 1.509 | 1.298 | 1.085 | 2.184 | 2.150 | 1.546 | 2.887 | 2.675 |
| 115 | 1.306 | 1.116 | 0.925 | 1.893 | 1.860 | 1.318 | 2.489 | 2.299 |
| 120 | 1.134 | 0.962 | 0.792 | 1.646 | 1.615 | 1.128 | 2.155 | 1.983 |
| 125 | 0.987 | 0.832 | 0.681 | 1.436 | 1.406 | 0.970 | 1.870 | 1.715 |

Continued on the following page. ↗

Temperature Sensor and Compensation Chip Type Temperature Characteristics (Center Value)

Continued from the preceding page. ↘

| Part Number | NCP□□WL683 | NC□□WF104D | NC□□WF104 | NCP□□WL104 | NCP□□WL154 | NC□□WM154 | NCP□□WL224 | NC□□WM224 |
|-------------|-----------------|-----------------|-----------------|-----------------|-----------------|-----------------|-----------------|-----------------|
| Resistance | 68kΩ | 100kΩ±0.5% | 100kΩ | 100kΩ | 150kΩ | 150kΩ | 220kΩ | 220kΩ |
| B-Constant | 4485K | 4250K | 4250K | 4485K | 4485K | 4500K | 4485K | 4500K |
| Temp. (°C) | Resistance (kΩ) | Resistance (kΩ) | Resistance (kΩ) | Resistance (kΩ) | Resistance (kΩ) | Resistance (kΩ) | Resistance (kΩ) | Resistance (kΩ) |
| -40 | 3317.893 | 4221.283 | 4397.119 | 4879.254 | 7318.881 | 7899.466 | 10734.358 | 11585.884 |
| -35 | 2330.237 | 2995.044 | 3088.599 | 3426.818 | 5140.228 | 5466.118 | 7539.001 | 8016.973 |
| -30 | 1653.862 | 2146.996 | 2197.225 | 2432.149 | 3648.224 | 3834.499 | 5350.729 | 5623.931 |
| -25 | 1185.641 | 1554.599 | 1581.881 | 1743.590 | 2615.385 | 2720.523 | 3835.898 | 3990.100 |
| -20 | 858.168 | 1136.690 | 1151.037 | 1262.012 | 1893.018 | 1951.216 | 2776.427 | 2861.784 |
| -15 | 626.875 | 839.019 | 846.579 | 921.875 | 1382.813 | 1415.565 | 2028.126 | 2076.162 |
| -10 | 461.974 | 624.987 | 628.988 | 679.373 | 1019.059 | 1036.984 | 1494.620 | 1520.909 |
| -5 | 343.345 | 469.678 | 471.632 | 504.919 | 757.379 | 767.079 | 1110.822 | 1125.049 |
| 0 | 257.266 | 355.975 | 357.012 | 378.333 | 567.499 | 572.667 | 832.332 | 839.912 |
| 5 | 194.287 | 272.011 | 272.500 | 285.717 | 428.575 | 431.264 | 628.577 | 632.521 |
| 10 | 147.841 | 209.489 | 209.710 | 217.414 | 326.121 | 327.405 | 478.310 | 480.194 |
| 15 | 113.325 | 162.559 | 162.651 | 166.654 | 249.981 | 250.538 | 366.639 | 367.455 |
| 20 | 87.484 | 127.057 | 127.080 | 128.653 | 192.979 | 193.166 | 283.036 | 283.310 |
| 25 | 68.000 | 100.000 | 100.000 | 100.000 | 150.000 | 150.000 | 220.000 | 220.000 |
| 30 | 53.208 | 79.222 | 79.222 | 78.247 | 117.370 | 117.281 | 172.143 | 172.012 |
| 35 | 41.903 | 63.167 | 63.167 | 61.622 | 92.433 | 92.293 | 135.569 | 135.364 |
| 40 | 33.208 | 50.677 | 50.677 | 48.835 | 73.252 | 73.090 | 107.436 | 107.198 |
| 45 | 26.477 | 40.904 | 40.904 | 38.937 | 58.406 | 58.240 | 85.662 | 85.419 |
| 50 | 21.237 | 33.195 | 33.195 | 31.231 | 46.846 | 46.665 | 68.708 | 68.441 |
| 55 | 17.137 | 27.091 | 27.091 | 25.202 | 37.803 | 37.605 | 55.444 | 55.153 |
| 60 | 13.904 | 22.224 | 22.224 | 20.448 | 30.671 | 30.453 | 44.984 | 44.665 |
| 65 | 11.342 | 18.323 | 18.323 | 16.679 | 25.018 | 24.804 | 36.694 | 36.379 |
| 70 | 9.299 | 15.184 | 15.184 | 13.675 | 20.513 | 20.293 | 30.085 | 29.763 |
| 75 | 7.662 | 12.635 | 12.635 | 11.268 | 16.902 | 16.679 | 24.789 | 24.462 |
| 80 | 6.343 | 10.566 | 10.566 | 9.329 | 13.993 | 13.776 | 20.523 | 20.205 |
| 85 | 5.276 | 8.873 | 8.873 | 7.758 | 11.638 | 11.428 | 17.068 | 16.761 |
| 90 | 4.407 | 7.481 | 7.481 | 6.481 | 9.721 | 9.520 | 14.258 | 13.962 |
| 95 | 3.697 | 6.337 | 6.337 | 5.437 | 8.155 | 7.966 | 11.961 | 11.684 |
| 100 | 3.114 | 5.384 | 5.384 | 4.580 | 6.869 | 6.688 | 10.075 | 9.809 |
| 105 | 2.634 | 4.594 | 4.594 | 3.873 | 5.810 | 5.639 | 8.521 | 8.270 |
| 110 | 2.236 | 3.934 | 3.934 | 3.289 | 4.933 | 4.772 | 7.236 | 6.998 |
| 115 | 1.907 | 3.380 | 3.380 | 2.804 | 4.206 | 4.052 | 6.169 | 5.942 |
| 120 | 1.632 | 2.916 | 2.916 | 2.400 | 3.601 | 3.454 | 5.281 | 5.067 |
| 125 | 1.403 | 2.522 | 2.522 | 2.064 | 3.096 | 2.955 | 4.540 | 4.334 |

| Part Number | NCP□□WF474 | NC□□WM474 |
|-------------|-----------------|-----------------|
| Resistance | 470kΩ±1% | 470kΩ |
| B-Constant | 4250K | 4500K |
| Temp. (°C) | Resistance (kΩ) | Resistance (kΩ) |
| -40 | 18632.4186 | 24751.661 |
| -35 | 13322.1161 | 17127.169 |
| -30 | 9596.7223 | 12014.762 |
| -25 | 7012.1677 | 8524.305 |
| -20 | 5148.6454 | 6113.811 |
| -15 | 3837.2457 | 4435.437 |
| -10 | 2870.6987 | 3249.216 |
| -5 | 2177.2734 | 2403.515 |
| 0 | 1657.5649 | 1794.358 |
| 5 | 1271.5627 | 1351.294 |
| 10 | 980.9354 | 1025.870 |
| 15 | 762.8640 | 785.018 |
| 20 | 596.7998 | 605.252 |
| 25 | 470.0000 | 470.000 |
| 30 | 372.5499 | 367.480 |
| 35 | 297.1820 | 289.186 |
| 40 | 238.3762 | 229.014 |
| 45 | 192.4150 | 182.485 |
| 50 | 156.0147 | 146.215 |
| 55 | 127.2622 | 117.828 |
| 60 | 104.1000 | 95.420 |
| 65 | 85.7325 | 77.718 |
| 70 | 70.8958 | 63.584 |
| 75 | 58.9516 | 52.260 |
| 80 | 49.1468 | 43.166 |
| 85 | 41.1989 | 35.808 |
| 90 | 34.6905 | 29.828 |
| 95 | 29.3049 | 24.961 |
| 100 | 24.8835 | 20.955 |
| 105 | 21.2079 | 17.668 |
| 110 | 18.1119 | 14.951 |
| 115 | 15.5330 | 12.695 |
| 120 | 13.3419 | 10.824 |
| 125 | 11.5013 | 9.259 |

Temperature Sensor and Compensation Chip Type ⚠Caution/Notice

⚠Caution (Storage and Operating Conditions)

This product is designed for application in an ordinary environment (normal room temperature, humidity and atmospheric pressure).

Do not use under the following conditions because all of these factors can deteriorate the product characteristics or cause failures and burn-out.

1. Corrosive gas or deoxidizing gas
(Chlorine gas, Hydrogen sulfide gas, Ammonia gas, Sulfuric acid gas, Nitric oxide gas, etc.)

2. Volatile or flammable gas
3. Dusty conditions
4. Under vacuum, or under high or low pressure
5. Wet or humid locations
6. Places with salt water, oils, chemical liquids or organic solvents
7. Strong vibrations
8. Other places where similar hazardous conditions exist

⚠Caution (Others)

Be sure to provide an appropriate fail-safe function on your product to prevent secondary damage that may be caused by the abnormal function or the failure of our product.

Notice (Storage and Operating Conditions)

To keep the solderability of the product from degrading, the following storage conditions are recommended.

1. Storage condition:
Temperature -10 to +40°C
Humidity less than 75%RH (not dewing condition)
2. Storage term:
Use this product within 6 months after delivery by first-in and first-out stocking system.
3. Storage place:
Do not store this product in corrosive gas (Sulfuric acid gas, Chlorine gas, etc.) or in direct sunlight.

Notice (Rating)

Use this product within the specified temperature range.

Higher temperature may cause deterioration of the characteristics or the material quality of this product.

Notice (Handling)

The ceramic of this product is fragile, and care must be taken not to load an excessive press-force or to cause a shock at handling.

Such forces may cause cracking or chipping.

Temperature Sensor and Compensation Chip Type ⚠️Caution/Notice

Notice (Soldering and Mounting)

1. Mounting Position

Choose a mounting position that minimizes the stress imposed on the chip during flexing or bending of the board.

Component Direction

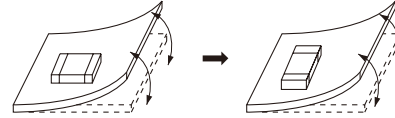

Locate this product horizontal to the direction in which stress acts.

Mounting Close to Board Separation Line



Keep this product on the PC Board away from the Separation Line.
 Worst ← A-C-B-D → Better

2. Allowable Soldering Temperature and Time

- Solder within the temperature and time combinations indicated by the slanted lines in the following graphs.
- Excessive soldering conditions may cause dissolution of metallization or deterioration of solder-wetting on the external electrode.
- In case of repeated soldering, the accumulated soldering time should be within the range shown in the figure below. (For example, Reflow peak temperature: 260°C, twice -> The total accumulated soldering time at 260°C is within 30sec.)

NCP03/15 Series, NCU15 Series

Allowable Reflow Soldering Temp. and Time

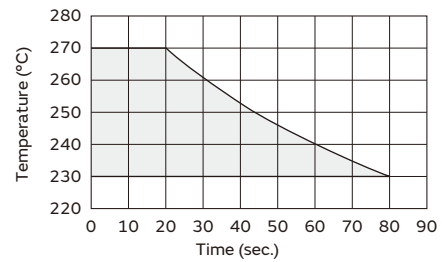

NCP18 Series, NCU18 Series

Allowable Flow Soldering Temp. and Time



Allowable Reflow Soldering Temp. and Time

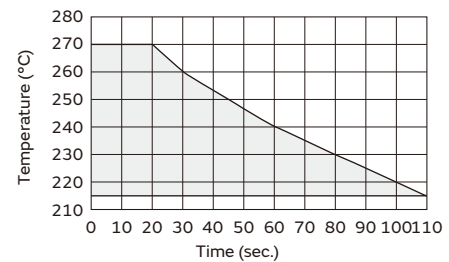

Continued on the following page. ↗

Temperature Sensor and Compensation Chip Type ⚠️Caution/Notice

Continued from the preceding page. ↘

3. Recommended Temperature Profile for Soldering

- (a) Insufficient preheating may cause a crack on the ceramic body. The difference between preheating temperature and maximum temperature in the profile shall be 100 °C.
 (b) Rapid cooling by dipping in solvent or by other means is not recommended.

* In case of repeated soldering, the accumulated soldering time should be within the range shown in the figure of section 2.

NCP03/15 Series, NCU15 Series

Reflow Soldering Conditions



NCP18 Series, NCU18 Series

Flow Soldering Conditions



Reflow Soldering Conditions



4. Solder and Flux

(1) Solder and Paste

(a) Reflow Soldering: NCP03/15/18 Series, NCU15/18 Series

For your reference, we use the solder paste below for any internal tests of this product.

● M705-GRM360-K2-V (Sn:Ag:Cu=96.5wt%:3.0wt%:0.5wt%)
 (Manufactured by Senju Metal Industry Co., Ltd.)

(b) Flow Soldering: NCP18 Series, NCU18 Series

We use the solder paste below for any internal tests of this product.

● Sn:Ag:Cu=96.5wt%:3.0wt%:0.5wt%

(2) Flux

Use rosin type flux in the soldering process.

If the flux listed below is used, some problems might be caused in the product characteristics and reliability.

Please do not use the following flux.

- Strong acidic flux (with halide content exceeding 0.1wt%).
- Water-soluble flux
 (*Water-soluble flux can be defined as non-rosin type flux including wash-type flux and non-wash-type flux.)

5. Cleaning Conditions

For removing the flux after soldering, observe the following points in order to avoid deterioration of the characteristics or any change of the external electrodes' quality.

- Please keep mounted parts and a substrate from an occurrence of resonance in ultrasonic cleaning.
- Please do not clean the products in the case of using a non-wash-type flux.

| | NCP03/15, NCU15 | NCP18, NCU18 |
|---------------------|---|---|
| Solvent | Isopropyl Alcohol | Isopropyl Alcohol |
| Dipping Cleaning | Less than 5min. at room temp. or less than 2min. at 40°C max. | Less than 5min. at room temp. or less than 2min. at 40°C max. |
| Ultrasonic Cleaning | Less than 5min. and 20W/ℓ Frequency of 28kHz to 40kHz | Less than 1min. and 20W/ℓ Frequency of several 10kHz to 100kHz |

6. Drying

After cleaning, promptly dry this product.

Continued on the following page. ↗

Temperature Sensor and Compensation Chip Type ⚠️Caution/Notice

Continued from the preceding page. ↘

7. Printing Conditions of Solder Paste

- The amount of solder is critical. Standard height of fillet is shown in the table below.
- Too much solder may cause mechanical stress, resulting in cracking, mechanical and/or electronic damage.



| Part Number | Solder Paste Thickness | T |
|--------------|------------------------|------------------------------|
| NCP03 | 100μm | $1/3E \leq T \leq E$ |
| NCP15, NCU15 | 150μm | $1/3E \leq T \leq E$ |
| NCP18, NCU18 | 200μm | $0.2\text{mm} \leq T \leq E$ |

8. Adhesive Application and Curing

- Thin or insufficient adhesive may result in loose component contact with land during flow soldering.
- Low viscosity adhesive causes chips to slip after mounting.

Temperature Sensor and Compensation Chip Type Package

Minimum Quantity Guide

| Part Number | Quantity (pcs.) | |
|--------------|-----------------|---------------|
| | Paper Tape | Embossed Tape |
| NCP03 | 15,000 | - |
| NCP15, NCU15 | 10,000 | |
| NCP18, NCU18 | 4,000 | |

Tape Carrier Packaging

1. Dimensions of Reel

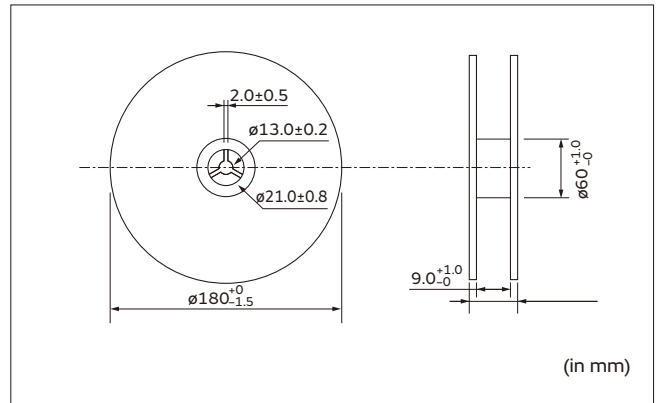

2. Taping Method

- (1) A tape in a reel contains Leader unit and Trailer unit where products are not packed. (Please refer to the figure at the right.)
- (2) The top and base tapes or plastic and cover tape are not stuck at the first five pitches minimum.
- (3) A label should be attached on the reel. (MURATA's part number, inspection number and quantity should be marked on the label.)
- (4) Taping reels are packed in a package.

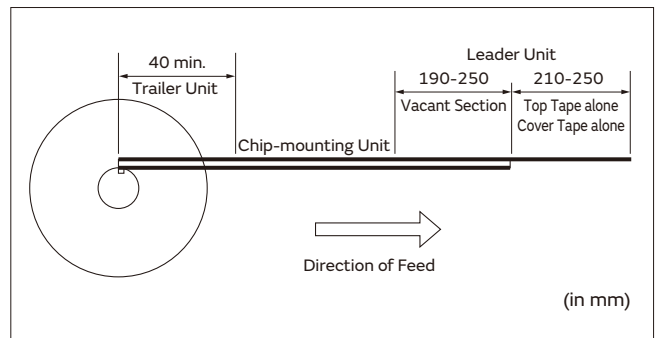

Continued on the following page. ↗

Temperature Sensor and Compensation Chip Type Package

Continued from the preceding page. ↘

3. Paper Tape (NCP03/15/18 Series, NCU15/18 Series)



(in mm)

(1) Other Conditions

(a) Packaging

Products are packaged in the cavity of the base tape and sealed by a top tape and bottom tape.

(b) Tape

The top tape and bottom tape have no joints and products are packaged and sealed in the cavity of the base tape, continuously.

(2) Peeling Force of Top Tape

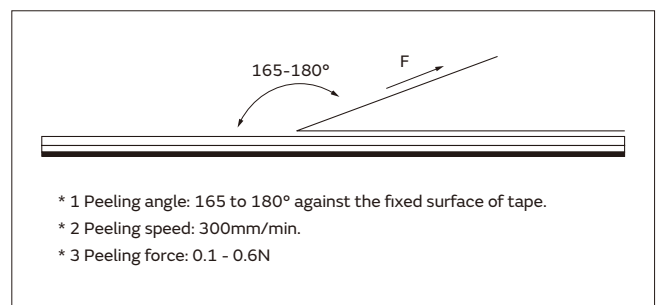

(3) Pull Strength

Pull strength of top tape is specified at 10N minimum.

Pull strength of bottom tape should be specified 5N minimum.

NTC Thermistors

Temperature Sensor Thermo String Cooper Wire Type

This product is a small flexible lead type NTC Thermistor with a small head and a thin lead wire.

Features

1. This small and highly accurate NTC Thermistor provides extremely precise temperature sensing.
2. The small sensing head and thin lead wire deliver temperature sensing in a narrow space.
3. Flexibility and a wide variety of lengths (60mm to 150mm) enable the design of flexible temperature sensing architectures.
4. This product is compatible with our 0402 (EIA) size chip Thermistor.
5. Excellent long-term stability
6. This is a halogen free product. *
 * Cl= max.900ppm, Br=max.900ppm and Cl+Br=max.1500ppm
7. NXFT series are recognized by UL/cUL. (UL1434, File No.E137188).

Applications

1. Temperature compensation for transistors, ICs, and crystal oscillators in mobile communications
2. Temperature sensor for rechargeable batteries
3. Temperature compensation of LCD
4. Temperature compensation in general use of electric circuits



NXFT15_1B Type (twist)



NXFT15_2B Type (without twist)

Detailed are accessible from the following URL.
<https://www.murata.com/en-global/products/thermistor/ntc/nxf>

| Part Number | Resistance (25°C) (ohm) | B-Constant (25-50°C) (K) | B-Constant (25-80°C) (Reference Value) (K) | B-Constant (25-85°C) (Reference Value) (K) | B-Constant (25-100°C) (Reference Value) (K) | Maximum Operating Current (25°C) (mA) | Rated Electric Power (25°C) (mW) | Typical Dissipation Constant (25°C) (mW/°C) | Thermal Time Constant (25°C) (s) |
|--------------------|-------------------------|--------------------------|--|--|---|---------------------------------------|----------------------------------|---|----------------------------------|
| NXFT15XM202EA□B□□□ | 2k±3% | 3500±1% | 3539 | 3545 | 3560 | 0.27 | 7.5 | 1.5 | 4 |
| NXFT15XV302FA□B□□□ | 3k±1% | 3936±1% | 3971 | 3977 | 3989 | 0.22 | 7.5 | 1.5 | 4 |
| NXFT15XH103FA□B□□□ | 10k±1% | 3380±1% | 3428 | 3434 | 3455 | 0.12 | 7.5 | 1.5 | 4 |
| NXFT15XV103FA□B□□□ | 10k±1% | 3936±1% | 3971 | 3977 | 3989 | 0.12 | 7.5 | 1.5 | 4 |
| NXFT15WB473FA□B□□□ | 47k±1% | 4050±1% | 4101 | 4108 | 4131 | 0.06 | 7.5 | 1.5 | 4 |
| NXFT15WF104FA□B□□□ | 100k±1% | 4250±1% | 4303 | 4311 | 4334 | 0.04 | 7.5 | 1.5 | 4 |

□ is filled with lead shape (1: twist, 2: without twist).

□□□ is filled with Total-length codes. (60 to 150mm interval 10mm, ex. 060=60mm)

Maximum Operating Current rises Thermistor's temperature by 0.1°C

Rated Electric Power shows the required electric power that the thermistor's temperature rise to 30°C by self-heating, at ambient temperature of 25 °C.

Operating Temperature Range: -40°C to +125°C

NTC Thermistors

Temperature Sensor Thermo String Nickel Copper Wire Type

This product is a small flexible lead type NTC Thermistor with a small head and a thin lead wire.

Features

1. This small and highly accurate NTC Thermistor provides extremely precise temperature sensing. Nickel Copper Wire Type has high thermal response than the Cooper Wire Type.
2. The small sensing head and thin lead wire deliver temperature sensing in a narrow space.
3. Flexibility and a wide variety of lengths (21mm to 50mm) enable the design of flexible temperature sensing architectures.
4. This product is compatible with our 0402 (EIA) size chip Thermistor.
5. Excellent long-term stability
6. This is a halogen free product. *
 * Cl= max.900ppm, Br=max.900ppm and
 Cl+Br=max.1500ppm
7. NXFT series are recognized by UL/cUL.
 (UL1434, File No.E137188).



Detailed are accessible from the following URL.
<https://www.murata.com/en-global/products/thermistor/ntc/nxf>

Applications

1. Temperature compensation for transistors, ICs, and crystal oscillators in mobile communications
2. Temperature sensor for rechargeable batteries
3. Temperature compensation of LCD
4. Temperature compensation in general use of electric circuits

| Part Number | Resistance (25°C) (ohm) | B-Constant (25-50°C) (K) | B-Constant (25-80°C) (Reference Value) (K) | B-Constant (25-85°C) (Reference Value) (K) | B-Constant (25-100°C) (Reference Value) (K) | Maximum Operating Current (25°C) (mA) | Rated Electric Power (25°C) (mW) | Typical Dissipation Constant (25°C) (mW/°C) | Thermal Time Constant (25°C) (s) |
|--------------------|-------------------------|--------------------------|--|--|---|---------------------------------------|----------------------------------|---|----------------------------------|
| NXFT15XV302FEAB□□□ | 3k±1% | 3936±1% | 3971 | 3977 | 3989 | 0.14 | 3 | 0.6 | 3 |
| NXFT15XV502FEAB□□□ | 5k±1% | 3936±1% | 3971 | 3977 | 3989 | 0.11 | 3 | 0.6 | 3 |
| NXFT15XH103FEAB□□□ | 10k±1% | 3380±1% | 3428 | 3434 | 3455 | 0.077 | 3 | 0.6 | 3 |
| NXFT15XV103FEAB□□□ | 10k±1% | 3936±1% | 3971 | 3977 | 3989 | 0.077 | 3 | 0.6 | 3 |
| NXFT15WB473FEAB□□□ | 47k±1% | 4050±1% | 4101 | 4108 | 4131 | 0.036 | 3 | 0.6 | 3 |
| NXFT15WF104FEAB□□□ | 100k±1% | 4250±1% | 4303 | 4311 | 4334 | 0.024 | 3 | 0.6 | 3 |

□□□ is filled with Total-length codes. (21mm, 25 to 50mm interval 5mm, ex. 050=50mm)

Maximum Operating Current rises Thermistor's temperature by 0.1°C

Rated Electric Power shows the required electric power that the thermistor's temperature rise to 30°C by self-heating, at ambient temperature of 25 °C.

Operating Temperature Range: -40°C to +125°C

Temperature Sensor Thermo String Type Specifications and Test Methods

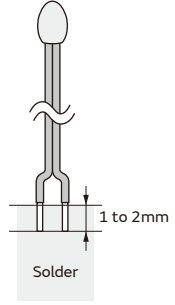
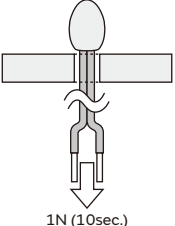
| No. | Item | Specifications | | Test Methods |
|-----|---------------------------------|---|---|--|
| | | Except XM202&XV302 | XM202&XV302 | |
| 1 | High Temperature Storage Test | · Resistance (R25°C) fluctuation rate: less than ±1%. · B-Constant (B25/50°C) fluctuation rate: less than ±1%. | · Resistance (R25°C) fluctuation rate: less than ±3%. · B-Constant (B25/50°C) fluctuation rate: less than ±2%. | 125±2°C in air, for 1000 +48/-0hrs. without loading. |
| 2 | Low Temperature Storage Test | | · Resistance (R25°C) fluctuation rate: less than ±1%. · B-Constant (B25/50°C) fluctuation rate: less than ±1%. | -40 +0/-3°C in air, for 1000 +48/-0hrs. without loading. |
| 3 | Humidity Storage Test | · Resistance (R25°C) fluctuation rate: less than ±2%. · B-Constant (B25/50°C) fluctuation rate: less than ±1%. | · Resistance (R25°C) fluctuation rate: less than ±2%. · B-Constant (B25/50°C) fluctuation rate: less than ±1%. | 60±2°C, 90 to 95%RH in air, for 1000 +48/-0hrs. without loading. |
| 4 | Temperature Cycle | | · Resistance (R25°C) fluctuation rate: less than ±3%. · B-Constant (B25/50°C) fluctuation rate: less than ±2%. | -40 +0/-3°C, 30min. in air +25±2°C, 10 to 15min. in air +125±2°C, 30min. in air +25 +2/-0°C, 10 to 15min. in air (1 cycle) Continuous 100 cycles, without loading. |
| 5 | High Temperature Load | | · Resistance (R25°C) fluctuation rate: less than ±3%. · B-Constant (B25/50°C) fluctuation rate: less than ±2%. | 85±2°C in air, with 'Operating Current for Sensor' for 1000 +48/-0hrs. |
| 6 | Insulation Break - down Voltage | · No damage electrical characteristics at DC100 V, 1min. | | 2mm length of coating resin from the top of Thermistor is to be dipped into beads of lead (Pb), and DC100V 1min. is applied to circuit between beads of lead (Pb) and lead wire. |
| 7 | Resistance to Soldering Heat | · Resistance (R25°C) fluctuation rate: less than ±1%. · B-Constant (B25/50°C) fluctuation rate: less than ±1%. | | Both lead wires are dipped into 350±10°C solder for 3.5±0.5sec., or 260±5°C solder for 10±1sec. according to Fig-1 (solder <JIS Z 3282 SnAgCu>).  <p style="text-align: center;">Fig-1</p> |
| 8 | Solderability | More than 90% of lead wire surface shall be covered by solder. | | Both lead wires are dipped into flux (25wt% colophony <JIS K 5902> isopropyl alcohol <JIS K 8839>) for 5 to 10sec. Then both lead wires are dipped into 245±5°C solder <JIS Z 3282 SnAgCu> for 2±0.5sec. according to Fig-1. |
| 9 | Lead Wire Pull Strength | · Resistance (R25°C) fluctuation rate: less than ±1%. · B-Constant (B25/50°C) fluctuation rate: less than ±1%. | | The lead wire shall be inserted in a ø1.0mm hole until resin part contacts with a substrate as shown in Fig.-2, and 1N force for 10sec. shall be applied to the lead wire.  <p style="text-align: center;">Fig-2</p> |

* · R25 is zero-power resistance at 25°C.
 · B25/50 is calculated by zero-power resistance of Thermistor in 25°C-50°C.
 · After each test, NTC Thermistor should be kept for 1hr. at room temperature (normal humidity and normal atmospheric pressure).

Continued on the following page. ↗

Temperature Sensor Thermo String Type Specifications and Test Methods

Continued from the preceding page. ↘

| No. | Item | Specifications | Test Methods |
|-----|----------------------------|---|---|
| 10 | Lead Wire Bending Strength | <ul style="list-style-type: none"> Lead wire does not break. | <p>Hold the lead wires as in Fig-3. Bend by 90 degrees and again bend back to the initial position. Then bend to the other side by 90 degrees and again bend back to the initial position. After bending process, 10N force for 3sec. shall be applied to the lead wire.</p>  <p>Fig-3</p> |
| 11 | Free Fall | | <p>NTC Thermistor shall be dropped without any force onto concrete floor from 1 meter height one time.</p> |
| 12 | Vibration | <ul style="list-style-type: none"> Resistance (R25°C) fluctuation rate: less than ±1%. B-Constant (B25/50°C) fluctuation rate: less than ±1%. No visible damage at resin part. | <p>NTC Thermistor shall be fixed to the vibration test equipment. Vibration of total 1.5 mm amplitude, Frequency sequence of 10Hz - 55Hz - 10Hz in 1min. shall be applied for right angled 3 directions for 2hrs. duration each.</p>  |

- * · R25 is zero-power resistance at 25°C.
- B25/50 is calculated by zero-power resistance of Thermistor in 25°C-50°C.
- After each test, NTC Thermistor should be kept for 1hr. at room temperature (normal humidity and normal atmospheric pressure).

4

NTC Thermistors

Temperature Sensor Lead Type

This thermistor is for normal temperature level sensors having self-subsistence due to strong lead strength based on chip NTC.

Features

1. This highly accurate NTC Thermistor provides extremely precise temperature sensing.
2. This product is compatible with 1005 (1.0mm x 0.5mm) size NTC Thermistor.
3. The variation per hour of this product is highly stable.
4. This product is produced with an automation line that was consistent from lead to packaging so that a product of uniform quality may be obtained at low cost in large quantities.
5. Since this product has strong lead intensity with original lead mounting technique, it is bent at the time of use and can withstand processing, etc., readily.
Taping package can be supported.



Detailed are accessible from the following URL.
<https://www.murata.com/en-global/products/thermistor/ntc/nxr>

Applications

1. For temperature detection of a rechargeable battery pack
2. For temperature detection of a charge circuit
3. For temperature detection of a printer head
4. For temperature detection of a DC fan motor
5. For temperature detection of home electronics

| Part Number | Resistance (25°C) (ohm) | B-Constant (25-50°C) (K) | B-Constant (25-80°C) (Reference Value) (K) | B-Constant (25-85°C) (Reference Value) (K) | B-Constant (25-100°C) (Reference Value) (K) | Maximum Operating Current (25°C) (mA) | Rated Electric Power (25°C) (mW) | Typical Dissipation Constant (25°C) (mW/°C) | Thermal Time Constant (25°C) (s) |
|--------------------|-------------------------|--------------------------|--|--|---|---------------------------------------|----------------------------------|---|----------------------------------|
| NXRT15XM202EA1B□□□ | 2k ±3% | 3500 ±1% | 3539 | 3545 | 3560 | 0.27 | 7.5 | 1.5 | 4 |
| NXRT15XV302FA1B□□□ | 3k ±1% | 3936 ±1% | 3971 | 3977 | 3989 | 0.22 | 7.5 | 1.5 | 4 |
| NXRT15XV502FA1B□□□ | 5k ±1% | 3936 ±1% | 3971 | 3977 | 3989 | 0.17 | 7.5 | 1.5 | 4 |
| NXRT15XH103FA1B□□□ | 10k ±1% | 3380 ±1% | 3428 | 3434 | 3455 | 0.12 | 7.5 | 1.5 | 4 |
| NXRT15XV103FA1B□□□ | 10k ±1% | 3936 ±1% | 3971 | 3977 | 3989 | 0.12 | 7.5 | 1.5 | 4 |
| NXRT15WB333JA1B□□□ | 33k ±5% | 4050 ±3% | 4101 | 4108 | 4131 | 0.07 | 7.5 | 1.5 | 4 |
| NXRT15WB473FA1B□□□ | 47k ±1% | 4050 ±1% | 4101 | 4108 | 4131 | 0.06 | 7.5 | 1.5 | 4 |
| NXRT15WF104FA1B□□□ | 100k ±1% | 4250 ±1% | 4303 | 4311 | 4334 | 0.04 | 7.5 | 1.5 | 4 |

□□□ is filled with Total-length codes. (10 to 50mm interval 10mm, ex. 040=40mm)

Maximum Operating Current rises Thermistor's temperature by 0.1°C.

Rated Electric Power is necessary electric power that thermistor's temperature rises 5°C by self-heating at 25°C in still air.

Taping type of part numbers with "3A016" is available (Lead Spacing=5mm).

Operating Temperature Range: -40°C to +125°C

Temperature Sensor Lead Type Specifications and Test Methods

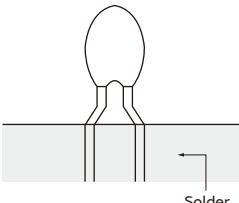
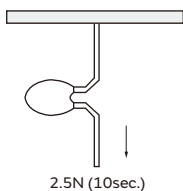
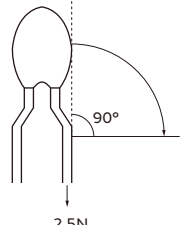
| No. | Item | Specifications | Test Methods |
|-----|---------------------------------|---|--|
| 1 | Low Temperature Storage Test | <ul style="list-style-type: none"> Resistance (R25°C) fluctuation rate: less than ±1%. B-Constant (B25/50°C) fluctuation rate: less than ±1%. | -40 +0/-3°C in air, for 1000 +48/-0hrs. without loading. |
| 2 | High Temperature Storage Test | | 125±2°C in air, for 1000 +48/-0hrs. without loading. |
| 3 | High Temperature Load | <ul style="list-style-type: none"> Resistance (R25°C) fluctuation rate: less than ±2%. B-Constant (B25/50°C) fluctuation rate: less than ±1%. | 85±2°C in air, with 'Operating Current for Sensor' for 1000 +48/-0hrs. |
| 4 | Humidity Storage Test | | 60±2°C, 90 to 95%RH in air, for 1000 +48/-0hrs. without loading. |
| 5 | Temperature Cycle | <ul style="list-style-type: none"> Resistance (R25°C) fluctuation rate: less than ±1%. B-Constant (B25/50°C) fluctuation rate: less than ±1%. | -40°C +0/-3°C, 30min. in air +25°C±2°C, 10 to 15min. in air +125°C +3/-0°C, 30min. in air +25°C +2/-0°C, 10 to 15min. in air (1 cycle) Continuous 100 cycles, without loading. |
| 6 | Insulation Break - down Voltage | | <ul style="list-style-type: none"> No damage electrical characteristics on D.C.100 V, 1min. 2mm length of coating resin from the top of thermistor is to be dipped into beads of lead (Pb), and DC100V 1min. is applied to circuit between beads of lead (Pb) and lead wire. |
| 7 | Resistance to Soldering Heat | <ul style="list-style-type: none"> Resistance (R25°C) fluctuation rate: less than ±1%. B-Constant (B25/50°C) fluctuation rate: less than ±1%. | Both lead wires are dipped into 350±10°C solder for 3.5±0.5sec., or 260±5°C solder for 10±1sec. according to Fig-1.  <p style="text-align: center;">Fig-1</p> |
| 8 | Solderability | <ul style="list-style-type: none"> More than 90% of lead wire surface shall be covered by solder. | Both lead wires are dipped into flux (25wt% colophony <JIS K 5902> isopropyl alcohol <JIS K 8839>) for 5 to 10 sec. Then both lead wires are dipped into 245±5°C solder <Sn-3Ag-0.5Cu> for 2±0.5sec. according to Fig-1. |
| 9 | Lead Wire Pull Strength | <ul style="list-style-type: none"> Resistance(R25°C) fluctuation rate: less than ±1%. B-Constant(B25/50°C) fluctuation rate: less than ±1%. No visible damage at resin part. | One end of a lead wire shall be fixed and 2.5N force for 10sec. shall be applied to the other lead wire as shown in Fig-2.  <p style="text-align: center;">Fig-2</p> |
| 10 | Lead Wire Bending Strength | <ul style="list-style-type: none"> Lead wire does not break. | One lead wire is held and 2.5N force is applied. Then the body of NTC thermistor is bent by 90° and again bent back to the initial position. This sequence shall be completed twice. See Fig-3.  <p style="text-align: center;">Fig-3</p> |
| 11 | Free Fall | <ul style="list-style-type: none"> Resistance (R25°C) fluctuation rate: less than ±1%. B-Constant (B25/50°C) fluctuation rate: less than ±1%. No visible damage at resin part. | NTC thermistor shall be dropped without any force onto concrete floor from 1 meter height one time. |
| 12 | Vibration | | NTC thermistor shall be fixed to the vibration test Equipment. Vibration of total 1.5mm amplitude, Frequency sequence of 10Hz – 55Hz – 10Hz in 1min., shall be applied for right angled 3 directions for 2hrs. duration each. |

* · R25 is zero-power resistance at 25°C.
 · B25/50 is calculated by zero-power resistance of Thermistor in 25°C-50°C.
 · After each test, NTC Thermistor should be kept for 1hr. at room temperature (normal humidity and normal atmospheric pressure).

5

NTC Thermistors

Temperature Sensor Lead Insulation Type

This thermistor is for normal temperature level sensors having self-subsistence due to strong lead strength based on chip NTC.

Features

1. NXR series can accurately detect temperature with NCP15 series on the head of parts.
2. The insulation coat with polyurethane on the surface of lead wire : 100VDC.
3. You can choose NTC characteristics from NCP15 series.
4. The resistance drift is low in the reliability test.
5. The production capacity is bigger and NXR is produced almost entirely in an automation line.
6. Adopt to Sb regulation



Detailed are accessible from the following URL.
<https://www.murata.com/en-global/products/thermistor/ntc/nxr>

Applications

1. Secondary battery
2. Temperature detection for charging
3. Temperature detection for DC fan motor
4. Temperature sensing for appliance
5. Self-standing temperature sensing for fire detector

| Part Number | Resistance (25°C) (ohm) | B-Constant (25-50°C) (K) | B-Constant (25-80°C) (Reference Value) (K) | B-Constant (25-85°C) (Reference Value) (K) | B-Constant (25-100°C) (Reference Value) (K) | Maximum Operating Current (25°C) (mA) | Rated Electric Power (25°C) (mW) | Typical Dissipation Constant (25°C) (mW/°C) | Thermal Time Constant (25°C) (s) |
|--------------------|-------------------------|--------------------------|--|--|---|---------------------------------------|----------------------------------|---|----------------------------------|
| NXRT15XM202EA5B□□□ | 2k ±3% | 3500 ±1% | 3539 | 3545 | 3560 | 0.36 | 13 | 2.6 | 4 |
| NXRT15XV302FA5B□□□ | 3k ±1% | 3936 ±1% | 3971 | 3977 | 3989 | 0.29 | 13 | 2.6 | 4 |
| NXRT15XV502FA5B□□□ | 5k ±1% | 3936 ±1% | 3971 | 3977 | 3989 | 0.23 | 13 | 2.6 | 4 |
| NXRT15XH103FA5B□□□ | 10k ±1% | 3380 ±1% | 3428 | 3434 | 3455 | 0.16 | 13 | 2.6 | 4 |
| NXRT15XV103FA5B□□□ | 10k ±1% | 3936 ±1% | 3971 | 3977 | 3989 | 0.16 | 13 | 2.6 | 4 |
| NXRT15WB333JA5B□□□ | 33k ±5% | 4050 ±3% | 4101 | 4108 | 4131 | 0.08 | 13 | 2.6 | 4 |
| NXRT15WB473FA5B□□□ | 47k ±1% | 4050 ±1% | 4101 | 4108 | 4131 | 0.07 | 13 | 2.6 | 4 |
| NXRT15WF104FA5B□□□ | 100k ±1% | 4250 ±1% | 4303 | 4311 | 4334 | 0.05 | 13 | 2.6 | 4 |

□□□ is filled with Total-length codes. (25 to 50mm interval 5mm, ex. 030=30mm)

Maximum Operating Current rises Thermistor's temperature by 0.1°C.

Rated Electric Power is necessary electric power that thermistor's temperature rises 5°C by self-heating at 25°C in still air.

Operating Temperature Range: -40°C to +125°C

Temperature Sensor Lead Insulation Type Specifications and Test Methods

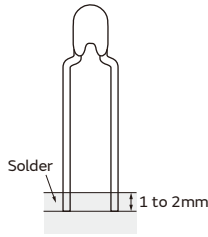
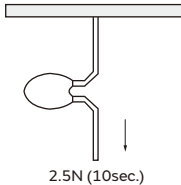
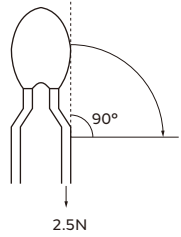
| No. | Item | Specifications | Test Methods |
|-----|---------------------------------------|---|---|
| 1 | Resistance to Soldering Heat (Flow) | <ul style="list-style-type: none"> Resistance (R25°C) fluctuation rate: less than ±1%. B-Constant (B25/50°C) fluctuation rate: less than ±1%. | <p>Both lead wires are dipped into 350±10°C solder for 3.5±0.5sec., or 260 ±5°C solder for 10±1sec. according to Fig-1. (solder <SnAgCu>)</p>  <p>Fig-1</p> |
| 2 | Solderability (Flow) | <ul style="list-style-type: none"> More than 90% of lead wire surface shall be covered by solder. | <p>Both lead wires are dipped into flux (25wt% colophony <JIS K 5902> isopropyl alcohol <JIS K 8839>) for 5 to 10sec. Then both lead wire are dipped into 245±5°C solder <SnAgCu> for 2±0.5sec. according to Fig-1.</p> |
| 3 | Lead Wire Breaking Strength | <ul style="list-style-type: none"> Resistance (R25°C) fluctuation rate: less than ±1%. B-Constant (B25/50°C) fluctuation rate: less than ±1%. | <p>One end of a lead wire shall be fixed and 2.5N force for 10sec. shall be applied to the other lead wire as shown in Fig-2.</p>  <p>Fig-2</p> |
| 4 | Lead Wire Bending Strength | <ul style="list-style-type: none"> Lead wire does not break. | <p>One lead wire is held and 2.5N force is applied. Then the body of NTC thermistor is bent by 90° and again bent back to the initial position. This sequence shall be completed twice. See Fig-3.</p>  <p>Fig-3</p> |
| 5 | Free Fall | | <p>NTC thermistor shall be dropped without any force onto concrete floor from 1 meter height one time.</p> |
| 6 | Vibration | <ul style="list-style-type: none"> Resistance (R25°C) fluctuation rate: less than ±1%. B-Constant (B25/50°C) fluctuation rate: less than ±1%. No visible damage at resin part. | <p>NTC thermistor shall be fixed to the vibration test equipment. Vibration of total 1.5 mm amplitude, frequency sequence of 10Hz - 55Hz - 10Hz in 1min., shall be applied for right angled 3 directions for 2hrs. duration each.</p> |
| 7 | Cold | <ul style="list-style-type: none"> Resistance (R25°C) fluctuation rate: less than ±1%. | <p>-40 +0/-3°C in air, for 1000 +48/-0hrs. without loading.</p> |
| 8 | Dry Heat | <ul style="list-style-type: none"> B-Constant (B25/50°C) fluctuation rate: less than ±1%. | <p>125±2°C in air, for 1000 +48/-0hrs. without loading.</p> |
| 9 | High Temperature with Continuous Load | | <p>85±2°C in air, with 'Operating Current for Sensor' for 1000 +48/-0hrs.</p> |
| 10 | Damp Heat | <ul style="list-style-type: none"> Resistance (R25°C) fluctuation rate: less than ±2%. B-Constant (B25/50°C) fluctuation rate: less than ±1%. | <p>60±2°C, 90 to 95%RH in air, for 1000 +48/-0hrs. without loading.</p> |
| 11 | Change of Temperature | | <p>-40°C +0/-3°C, 30min. in air +25°C±2°C, 10 to 15min. in air +125°C +3/-0°C, 30min. in air +25°C +2/-0°C, 10 to 15min. in air (1 cycle) Continuous 100 +4/-0 cycles, without loading.</p> |
| 12 | Dielectric Breakdown Voltage | <ul style="list-style-type: none"> No damage electrical characteristics on D.C.100V, 1min. | <p>2mm length of coating resin from the top of thermistor is to be dipped into beads of lead (Pb), and DC100V 1min. is applied to circuit between beads of lead (Pb) and lead wire.</p> |

Temperature Sensor Thermo String/Lead Type Temperature Characteristics (Center Value)

| Part Number | NXFT15XM202 | NXFT15XV302 | NXFT15XV502 | NXFT15XH103 | NXFT15XV103 | NXFT15WB473 | NXFT15WF104 |
|-------------|-----------------|-----------------|-----------------|-----------------|-----------------|-----------------|-----------------|
| Resistance | 2kΩ | 3kΩ | 5kΩ | 10kΩ | 10kΩ | 47kΩ | 100kΩ |
| B-Constant | 3500K | 3936K | 3936K | 3380K | 3936K | 4050K | 4250K |
| Temp. (°C) | Resistance (kΩ) | Resistance (kΩ) | Resistance (kΩ) | Resistance (kΩ) | Resistance (kΩ) | Resistance (kΩ) | Resistance (kΩ) |
| -40 | 44.981 | 101.251 | 168.752 | 195.652 | 337.503 | 1747.920 | 4397.119 |
| -35 | 33.671 | 73.000 | 121.666 | 148.171 | 243.332 | 1245.428 | 3088.599 |
| -30 | 25.444 | 53.249 | 88.748 | 113.347 | 177.496 | 898.485 | 2197.225 |
| -25 | 19.417 | 39.258 | 65.430 | 87.559 | 130.859 | 655.802 | 1581.881 |
| -20 | 14.955 | 29.228 | 48.714 | 68.237 | 97.428 | 483.954 | 1151.037 |
| -15 | 11.619 | 21.969 | 36.615 | 53.650 | 73.230 | 360.850 | 846.579 |
| -10 | 9.097 | 16.659 | 27.764 | 42.506 | 55.529 | 271.697 | 628.988 |
| -5 | 7.178 | 12.740 | 21.233 | 33.892 | 42.467 | 206.463 | 471.632 |
| 0 | 5.707 | 9.824 | 16.374 | 27.219 | 32.747 | 158.214 | 357.012 |
| 5 | 4.568 | 7.635 | 12.725 | 22.021 | 25.450 | 122.259 | 272.500 |
| 10 | 3.682 | 5.980 | 9.966 | 17.926 | 19.932 | 95.227 | 209.710 |
| 15 | 2.986 | 4.718 | 7.864 | 14.674 | 15.727 | 74.730 | 162.651 |
| 20 | 2.437 | 3.749 | 6.249 | 12.081 | 12.498 | 59.065 | 127.080 |
| 25 | 2.000 | 3.000 | 5.000 | 10.000 | 10.000 | 47.000 | 100.000 |
| 30 | 1.651 | 2.416 | 4.027 | 8.315 | 8.054 | 37.643 | 79.222 |
| 35 | 1.370 | 1.959 | 3.264 | 6.948 | 6.529 | 30.334 | 63.167 |
| 40 | 1.143 | 1.597 | 2.662 | 5.834 | 5.324 | 24.591 | 50.677 |
| 45 | 0.958 | 1.310 | 2.183 | 4.917 | 4.366 | 20.048 | 40.904 |
| 50 | 0.807 | 1.080 | 1.801 | 4.161 | 3.601 | 16.433 | 33.195 |
| 55 | 0.682 | 0.896 | 1.493 | 3.535 | 2.985 | 13.539 | 27.091 |
| 60 | 0.580 | 0.746 | 1.244 | 3.014 | 2.488 | 11.209 | 22.224 |
| 65 | 0.495 | 0.625 | 1.041 | 2.586 | 2.083 | 9.328 | 18.323 |
| 70 | 0.424 | 0.526 | 0.876 | 2.228 | 1.752 | 7.798 | 15.184 |
| 75 | 0.365 | 0.444 | 0.740 | 1.925 | 1.480 | 6.544 | 12.635 |
| 80 | 0.315 | 0.377 | 0.628 | 1.669 | 1.256 | 5.518 | 10.566 |
| 85 | 0.273 | 0.321 | 0.535 | 1.452 | 1.070 | 4.674 | 8.873 |
| 90 | 0.237 | 0.275 | 0.458 | 1.268 | 0.916 | 3.972 | 7.481 |
| 95 | 0.207 | 0.236 | 0.394 | 1.110 | 0.787 | 3.388 | 6.337 |
| 100 | 0.181 | 0.204 | 0.340 | 0.974 | 0.679 | 2.902 | 5.384 |
| 105 | 0.160 | 0.177 | 0.294 | 0.858 | 0.588 | 2.494 | 4.594 |
| 110 | 0.141 | 0.154 | 0.256 | 0.758 | 0.512 | 2.150 | 3.934 |
| 115 | 0.124 | 0.134 | 0.223 | 0.672 | 0.446 | 1.860 | 3.380 |
| 120 | 0.110 | 0.117 | 0.195 | 0.596 | 0.391 | 1.615 | 2.916 |
| 125 | 0.098 | 0.103 | 0.172 | 0.531 | 0.343 | 1.406 | 2.522 |

| Part Number | NXRT15XM202 | NXRT15XV302 | NXRT15XV502 | NXRT15XH103 | NXRT15XV103 | NXRT15WB333 | NXRT15WB473 | NXRT15WF104 |
|-------------|-----------------|-----------------|-----------------|-----------------|-----------------|-----------------|-----------------|-----------------|
| Resistance | 2.0kΩ | 3.0kΩ | 5.0kΩ | 10kΩ | 10kΩ | 33kΩ | 47kΩ | 100kΩ |
| B-Constant | 3500K | 3936K | 3936K | 3380K | 3936K | 4050K | 4050K | 4250K |
| Temp. (°C) | Resistance (kΩ) | Resistance (kΩ) | Resistance (kΩ) | Resistance (kΩ) | Resistance (kΩ) | Resistance (kΩ) | Resistance (kΩ) | Resistance (kΩ) |
| -40 | 44.981 | 101.251 | 168.752 | 195.652 | 337.503 | 1227.263 | 1747.920 | 4397.119 |
| -35 | 33.671 | 73.000 | 121.666 | 148.171 | 243.332 | 874.449 | 1245.428 | 3088.599 |
| -30 | 25.444 | 53.249 | 88.748 | 113.347 | 177.496 | 630.851 | 898.485 | 2197.225 |
| -25 | 19.417 | 39.258 | 65.430 | 87.559 | 130.859 | 460.457 | 655.802 | 1581.881 |
| -20 | 14.955 | 29.228 | 48.714 | 68.237 | 97.428 | 339.797 | 483.954 | 1151.037 |
| -15 | 11.619 | 21.969 | 36.615 | 53.650 | 73.230 | 253.363 | 360.850 | 846.579 |
| -10 | 9.097 | 16.659 | 27.764 | 42.506 | 55.529 | 190.766 | 271.697 | 628.988 |
| -5 | 7.178 | 12.740 | 21.233 | 33.892 | 42.467 | 144.964 | 206.463 | 471.632 |
| 0 | 5.707 | 9.824 | 16.374 | 27.219 | 32.747 | 111.087 | 158.214 | 357.012 |
| 5 | 4.568 | 7.635 | 12.725 | 22.021 | 25.450 | 85.842 | 122.259 | 272.500 |
| 10 | 3.682 | 5.980 | 9.966 | 17.926 | 19.932 | 66.861 | 95.227 | 209.710 |
| 15 | 2.986 | 4.718 | 7.864 | 14.674 | 15.727 | 52.470 | 74.730 | 162.651 |
| 20 | 2.437 | 3.749 | 6.249 | 12.081 | 12.498 | 41.471 | 59.065 | 127.080 |
| 25 | 2.000 | 3.000 | 5.000 | 10.000 | 10.000 | 33.000 | 47.000 | 100.000 |
| 30 | 1.651 | 2.416 | 4.027 | 8.315 | 8.054 | 26.430 | 37.643 | 79.222 |
| 35 | 1.370 | 1.959 | 3.264 | 6.948 | 6.529 | 21.298 | 30.334 | 63.167 |
| 40 | 1.143 | 1.597 | 2.662 | 5.834 | 5.324 | 17.266 | 24.591 | 50.677 |
| 45 | 0.958 | 1.310 | 2.183 | 4.917 | 4.366 | 14.076 | 20.048 | 40.904 |
| 50 | 0.807 | 1.080 | 1.801 | 4.161 | 3.601 | 11.538 | 16.433 | 33.195 |
| 55 | 0.682 | 0.896 | 1.493 | 3.535 | 2.985 | 9.506 | 13.539 | 27.091 |
| 60 | 0.580 | 0.746 | 1.244 | 3.014 | 2.488 | 7.870 | 11.209 | 22.224 |
| 65 | 0.495 | 0.625 | 1.041 | 2.586 | 2.083 | 6.549 | 9.328 | 18.323 |
| 70 | 0.424 | 0.526 | 0.876 | 2.228 | 1.752 | 5.475 | 7.798 | 15.184 |
| 75 | 0.365 | 0.444 | 0.740 | 1.925 | 1.480 | 4.595 | 6.544 | 12.635 |
| 80 | 0.315 | 0.377 | 0.628 | 1.669 | 1.256 | 3.874 | 5.518 | 10.566 |
| 85 | 0.273 | 0.321 | 0.535 | 1.452 | 1.070 | 3.282 | 4.674 | 8.873 |
| 90 | 0.237 | 0.275 | 0.458 | 1.268 | 0.916 | 2.789 | 3.972 | 7.481 |
| 95 | 0.207 | 0.236 | 0.394 | 1.110 | 0.787 | 2.379 | 3.388 | 6.337 |
| 100 | 0.181 | 0.204 | 0.340 | 0.974 | 0.679 | 2.038 | 2.902 | 5.384 |
| 105 | 0.160 | 0.177 | 0.294 | 0.858 | 0.588 | 1.751 | 2.494 | 4.594 |
| 110 | 0.141 | 0.154 | 0.256 | 0.758 | 0.512 | 1.509 | 2.150 | 3.934 |
| 115 | 0.124 | 0.134 | 0.223 | 0.672 | 0.446 | 1.306 | 1.860 | 3.380 |
| 120 | 0.110 | 0.117 | 0.195 | 0.596 | 0.391 | 1.134 | 1.615 | 2.916 |
| 125 | 0.098 | 0.103 | 0.172 | 0.531 | 0.343 | 0.987 | 1.406 | 2.522 |

Temperature Sensor Thermo String/Lead Type ⚠Caution/Notice

⚠Caution (Storage and Operating Conditions)

This product is designed for application in an ordinary environment (normal room temperature, humidity and atmospheric pressure).

Do not use under the following conditions because all of these factors can deteriorate the product characteristics or cause failures and burn-out.

1. Corrosive gas or deoxidizing gas
(Chlorine gas, Hydrogen sulfide gas, Ammonia gas, Sulfuric acid gas, Nitric oxide gas, etc.)

2. Volatile or flammable gas
3. Dusty conditions
4. Under vacuum, or under high or low pressure
5. Wet or humid locations
6. Places with salt water, oils, chemical liquids or organic solvents
7. Strong vibrations
8. Other places where similar hazardous conditions exist

⚠Caution (Others)

Be sure to provide an appropriate fail-safe function on your product to prevent secondary damage that may be caused by the abnormal function or the failure of our product.

Notice (Storage and Operating Conditions)

To keep the solderability of the product from degrading, the following storage condition is recommended.

1. Storage condition:
Temperature -10 to +40°C
Humidity less than 75%RH (not dewing condition)
2. Storage term:
Use this product within 6 months after delivery by first-in and first-out stocking system.

3. Handling after unpacking:
After unpacking, reseal product promptly or store it in a sealed container with a drying agent.
4. Storage place:
Do not store this product in corrosive gas (Sulfuric acid gas, Chlorine gas, etc.) or in direct sunlight.

Notice (Rating)

Use this product within the specified temperature range.

Higher temperature may cause deterioration of the characteristics or the material quality of this product.

Notice (Soldering and Mounting) NXF Series

Please note as shown below when you mount this product.

1. Do not melt the solder in the resin head when you solder this product. If you do so, there is a possibility of wire breakage, electric short mode failure and wire coating breakage. If you cut the lead wire of this product less than 20mm from the resin head, the heat of the melted solder at the lead wire edge is propagated easily to the resin head along the lead wire.
2. Do not touch the resin head directly with the soldering iron. It may cause the melting of solder in the resin head.
3. Do not separate the parallel lead wires 10mm or less from the resin.
4. If you mold this product with resin, please evaluate the quality of this product before you use it.
5. Do not bend the lead wire radius 1mm or more.

Continued on the following page. ↗

Temperature Sensor Thermo String/Lead Type ⚠️Caution/Notice

Continued from the preceding page. ↘

Notice (Soldering and Mounting) NXR Series

Please note as shown below when you mount this product.

1. Do not melt the solder in the resin head, when you solder this product. If you melt the solder in resin the head, the wire could break and short.

If you cut the lead wire of this product less than 8mm from the resin head, the heat of the melted solder at the lead wire edge is propagated easily to the resin head along the lead wire. Please do not cut this product below 9mm.

2. Do not touch the resin head directly with the solder iron. It may cause the melting of solder in the resin head.
3. If you mold this product with resin, please evaluate the quality of this product before you use it.

Notice (Soldering and Mounting) NXR Series (Insulation Type)

Please note as shown below when you mount this product.

1. Do not melt the solder in the resin head when you solder this product. (more than 25mm in full length of the product).

If you melt the solder in the resin head, it has possibility that the wire could break and short.

2. Do not touch the resin head directly with the solder iron. It may cause the melting of solder in the resin head.
3. When additional processing is carried out on this product (such as bonding, resin molding, and resin coating, etc.), please perform an audit of quality level on an automated machine and only use the product after confirming its reliability.

Please talk to us if you have concern matter, like process it under the high temperature and the high pressure.

(For example, exposed to high-temperature and high-pressure environment as mold sealing with injection molding.)

Notice (Handling) NXF/NXR Series

1. The ceramic element of this product is fragile, and care must be taken not to load an excessive press-force or not to cause a shock at handling. Such forces may cause cracking or chipping.
2. Do not apply excessive force to the lead. Otherwise, it may cause the junction between lead and element to break or crack. Holding the element by the side lead wire is recommended when lead wire is bent or cut.

Notice (Handling) NXR Series (Insulation Type)

1. The ceramic element of this product is fragile, and care must be taken not to load an excessive press-force or not to cause a shock at handling. Such forces may cause cracking or chipping. Especially under high-temperature environment, there is a possibility that epoxy resin will become soft. When you set up the processing environment, please examine the processing method after evaluating the quality of this product.

2. Do not apply excessive force to the lead. Otherwise, it may cause the junction between lead and element to break or crack. Holding the element by the side lead wire is recommended when lead wire is bent or cut. Handle the lead with care; there is a possibility that a crack may go into the polyurethane insulated coat when bending the lead.

Temperature Sensor Thermo String/Lead Type Package

Minimum Order Quantity

| Bulk | | Ammo Pack Taping | |
|-------------|-------------------------|------------------|-------------------------|
| Part Number | Minimum Quantity (pcs.) | Part Number | Minimum Quantity (pcs.) |
| NXF | 1,000 | - | - |
| NXR | 500 | NXRT_3A016 | 2,500 |

Taping Dimensions (NXRT_3A016 Series)



| Item | Code | Dimensions (mm) |
|---|----------|------------------------------------|
| Pitch of Component | P | 12.7±1.0 |
| Pitch of Sprocket Hole | P0 | 12.7±0.3 |
| Lead Spacing | F | 5.0±1.0 |
| Length from Hole Center to Component Center | P2 | 6.35±1.3 |
| Length from Hole Center to Lead | P1 | 3.85±0.7 |
| Body Diameter | D | 4.0 max. |
| Deviation Along Tape, Left or Right | ΔS | 0±2.0 |
| Carrier Tape Width | W3 | 18.0±0.5 |
| Position of Sprocket Hole | W1 | 9.0±0.5 |
| Lead Distance between Reference and Bottom Planes | H0 | 16.0±1.0 |
| Height of Component | H3 | 7.5±1.0 |
| Protrusion Length | I | +0.5 to -1.0 |
| Diameter of Sprocket Hole | øD0 | 4.0±0.1 |
| Lead Diameter | ød | 0.40±0.05 |
| Total Tape Thickness | t1 | 0.6±0.3 |
| Total Thickness, Tape and Lead Wire | t2 | 1.6 max. |
| Deviation Across Tape | Δh1, Δh2 | 1.0 max. |
| Portion to Cut in Case of Defect | L3 | 11.0 ⁺⁰ _{-2.0} |
| Hold down Tape Width | W0 | 9.5 min. |
| Hold down Tape Position | W2 | 1.5±1.5 |
| Thickness | T | 2.0 max. |