

NTC Thermistors





EU RoHS Compliant

- All the products in this catalog comply with EU RoHS.
- EU RoHS is "the European Directive 2011/65/EU on the Restriction of the Use of Certain Hazardous Substances in Electrical and Electronic Equipment."
- For more details, please refer to our web page, "Murata's Approach for EU RoHS" (<https://www.murata.com/en-eu/support/compliance/rohs>).

Contents

Product specifications are as of February 2020.

Part Numbering	p2
Basic Characteristics	p5
<hr/>	
1 Temperature Sensor and Compensation 0201 (0603) Size	p6
<hr/>	
2 Temperature Sensor and Compensation 0402 (1005) Size/NCP Series	p7
Temperature Sensor and Compensation 0402 (1005) Size/NCU Series	p9
<hr/>	
3 Temperature Sensor and Compensation 0603 (1608) Size/NCP Series	p10
Temperature Sensor and Compensation 0603 (1608) Size/NCU Series	p12
<hr/>	
Temperature Sensor and Compensation Chip Type Standard Land Pattern Dimensions	p13
Temperature Sensor and Compensation Chip Type Temperature Characteristics (Center Value)	p14
Temperature Sensor and Compensation Chip Type ⚠Caution/Notice	p17
Temperature Sensor and Compensation Chip Type Package	p21
<hr/>	
4 Temperature Sensor Thermo String Cooper Wire Type	p23
Temperature Sensor Thermo String Nickel Copper Wire Type	p24
Temperature Sensor Thermo String Type Specifications and Test Methods	p25
<hr/>	
5 Temperature Sensor Lead Type	p27
Temperature Sensor Lead Type Specifications and Test Methods	p28
<hr/>	
6 Temperature Sensor Lead Insulation Type ...	p29
Temperature Sensor Lead Insulation Type Specifications and Test Methods	p30
<hr/>	
Temperature Sensor Thermo String/Lead Type Temperature Characteristics (Center Value)	p31
Temperature Sensor Thermo String/Lead Type ⚠Caution/Notice	p32
Temperature Sensor Thermo String/Lead Type Package	p34

Please check the MURATA website (<https://www.murata.com/>) if you cannot find a part number in this catalog.

● Part Numbering

NTC Thermistors for Temp. Sensor and Compensation Chip Type

(Part Number)

NC	P	18	XH	103	J	03	RB
①	②	③	④	⑤	⑥	⑦	⑧

① Product ID

Product ID	
NC	NTC Thermistors Chip Type

② Series

Code	Series
P	Plated Termination Series
U	High Reliability Series

③ Dimensions (L x W)

Code	Dimensions (L x W)	EIA
03	0.60 x 0.30mm	0201
15	1.00 x 0.50mm	0402
18	1.60 x 0.80mm	0603
21	2.00 x 1.25mm	0805

④ Temperature Characteristics

Code	Temperature Characteristics
XC	Nominal B-Constant 3100–3149K
XF	Nominal B-Constant 3250–3299K
XH	Nominal B-Constant 3350–3399K
XM	Nominal B-Constant 3500–3549K
XQ	Nominal B-Constant 3650–3699K
XV	Nominal B-Constant 3900–3949K
XW	Nominal B-Constant 3950–3999K
WB	Nominal B-Constant 4050–4099K
WD	Nominal B-Constant 4150–4199K
WF	Nominal B-Constant 4250–4299K
WL	Nominal B-Constant 4450–4499K
WM	Nominal B-Constant 4500–4549K

⑤ Resistance

Expressed by three-digit alphanumerics. The unit is ohm (Ω). The first and second figures are significant digits, and the third figure expresses the number of zeros that follow the two figures.

Ex.

Code	Resistance
102	1k Ω
103	10k Ω
104	100k Ω

⑥ Resistance Tolerance

Code	Resistance Tolerance
D	$\pm 0.5\%$
F	$\pm 1\%$
E	$\pm 3\%$
J	$\pm 5\%$

⑦ Individual Specifications

Structures and other specifications are expressed by two figures.

Ex.

Code	Individual Specifications
03/05/10/12/60	Standard Type
<input type="checkbox"/> S	Automotive Type

⑧ Packaging

Code	Packaging
RA	Plastic Taping 4mm Pitch (4000 pcs.)
RB	Paper Taping 4mm Pitch (4000 pcs.)
RC	Paper Taping 2mm Pitch (10000 pcs.)
RL	Paper Taping 2mm Pitch (15000 pcs.)

NTC Thermistor for Temperature Sensor Thermo String Type

(Part Number)

NXF	T	15	XH	103	F	A	2	B	025
①	②	③	④	⑤	⑥	⑦	⑧	⑨	⑩

① Product ID

Product ID	
NXF	NTC Thermistors Sensor Thermo String Type

② Individual Specifications

Code	Individual Specifications
T	Commercial Type

③ Chip Dimensions

Code	Dimensions (L x T)	EIA
15	1.00 x 0.50mm	0402

④ Temperature Characteristics

Code	Temperature Characteristics
XH	Nominal B-Constant 3350–3399K
XM	Nominal B-Constant 3500–3549K
XV	Nominal B-Constant 3900–3949K
WB	Nominal B-Constant 4050–4099K
WF	Nominal B-Constant 4250–4299K

⑤ Resistance

Expressed by three figures. The unit is (Ω). The first and second figures are significant digits, and the third figure expresses the number of zeros that follow the two figures.

Ex.

Code	Resistance
103	10kΩ
473	47kΩ
104	100kΩ

⑥ Resistance Tolerance

Code	Resistance Tolerance
F	±1%
E	±3%

⑦ Lead Wire Type

Code	Lead Wire Type
A	∅0.3mm Copper Lead Wire with Polyurethane Coat
E	∅0.3mm Nickel Copper Lead Wire with Modified Polyester Coat

⑧ Shape of the Lead Wire Kink

Code	Shape of the Lead Wire Kink
1	Twisted Lead Wire Type
2	Standard Type (Cooper Wire Type)
A	Standard Type (Nickel Copper Wire Type)

⑨ Packaging

Code	Packaging
B	Bulk

⑩ Dimensions (Full Length)

Code	Dimensions (Full Length)
021	21mm
025	25mm
030	30mm
035	35mm
040	40mm
045	45mm
050	50mm
060	60mm
070	70mm
080	80mm
090	90mm
100	100mm
110	110mm
120	120mm
130	130mm
140	140mm
150	150mm

NTC Thermistor for Temperature Sensor/Lead Type

(Part Number)

NXR	T	15	XH	103	F	A	1	B	040
①	②	③	④	⑤	⑥	⑦	⑧	⑨	⑩

① Product ID

Product ID	
NXR	NTC Thermistor Sensor/Lead Type

② Individual Specifications

Code	Individual Specifications
T	Commercial Type

③ Chip Dimensions

Code	Dimensions (L x T)
15	1.00 x 0.50mm

④ Temperature Characteristics

Code	Temperature Characteristics
XH	Nominal B-Constant 3350–3399K
XM	Nominal B-Constant 3500–3549K
XV	Nominal B-Constant 3900–3949K
WB	Nominal B-Constant 4050–4099K
WF	Nominal B-Constant 4250–4299K

⑤ Resistance

Expressed by three figures. The unit is (Ω). The first and second figures are significant digits, and the third figure expresses the number of zeros that follow the two figures.

Ex.

Code	Resistance
202	2.0kΩ
103	10kΩ
104	100kΩ

⑥ Resistance Tolerance

Code	Resistance Tolerance
F	±1%
E	±3%
J	±5%

⑦ Lead Wire Type

Code	Lead Wire Type
A	Lead Type: ø0.4mm Copper-clad Fe Wire, Tinned Lead Insulation Type: ø0.46mm Cu Wire with Coat

⑧ Shape of the Lead Wire

Code	Shape of the Lead Wire
1	Lead Spacing 2.5mm
3	Lead Spacing 5.0mm
5	Lead Spacing 2.5mm (Insulation Type)

⑨ Packaging

Code	Packaging
A	Ammo Pack Taping
B	Bulk

⑩ Dimensions (Full Length)

Code	Lead Type	Lead Insulation Type
010	10mm	–
020	20mm	–
025	–	25mm
030	30mm	30mm
035	–	35mm
040	40mm	40mm
045	–	45mm
050	50mm	50mm
016	16mm (Taping Type)	–

Basic Characteristics

Basic Characteristics

1. Zero-power Resistance of Thermistor: R

$$R=R_0 \exp B (1/T-1/T_0) \dots\dots\dots (1)$$

R: Resistance in ambient temperature T (K)
 (K: absolute temperature)

R₀: Resistance in ambient temperature T₀ (K)

B: B-Constant of Thermistor

2. B-Constant

as (1) formula

$$B = \ln (R/R_0) / (1/T-1/T_0)$$

3. Thermal Dissipation Constant

When electric power P (mW) is spent in ambient temperature T₁ and thermistor temperature rises T₂, the formula is as follows

$$P=C (T_2-T_1)$$

C: Thermal dissipation constant (mW/°C)

Thermal dissipation constant is varied with dimensions, measurement conditions, etc.

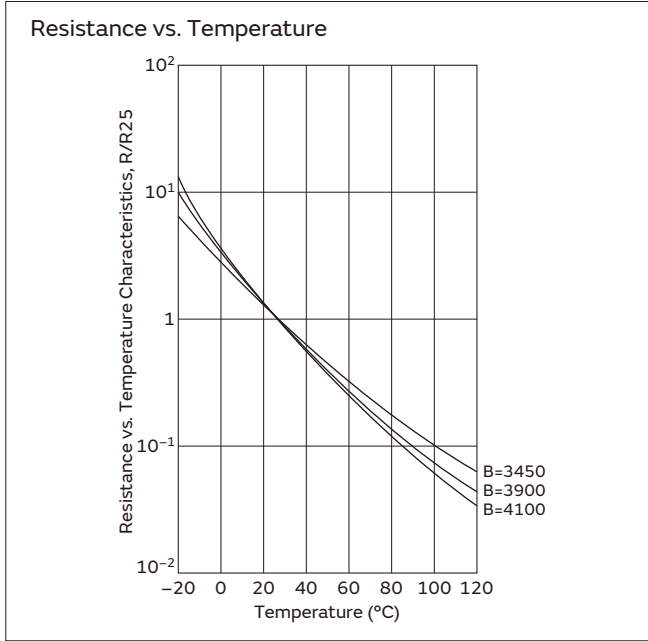

4. Thermal Time Constant

Period in which the thermistor's temperature will change 63.2% of its temperature difference from ambient temperature T₀ (°C) to T₁ (°C).

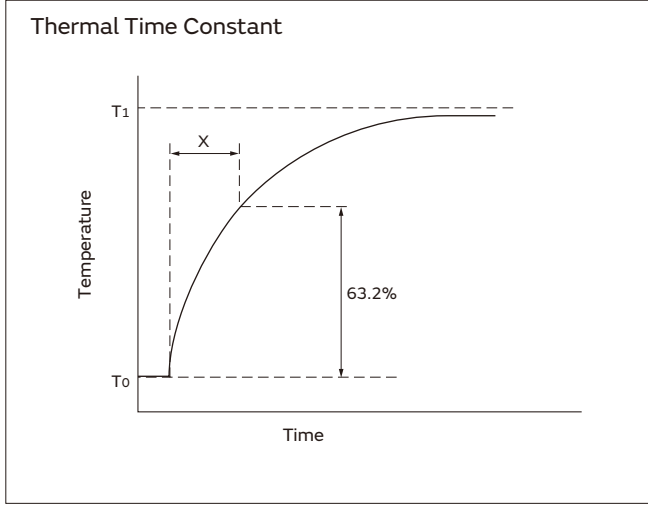

Performance

Item	Condition
Resistance	Measured by zero-power in specified ambient temperature.
B-Constant	Calculated between two specified ambient temperatures by the next formula. T and T ₀ is absolute temperature (K). $B = \frac{\ln (R/R_0)}{1/T-1/T_0}$
Thermal Dissipation Constant	Shows necessary electric power that Thermistor's temperature rises 1°C by self-heating. It is calculated by the next formula (mW/°C). $C = \frac{P}{T-T_0}$
Maximum Operating Current	It is possible to keep the thermistor's temperature rising max. 0.1°C.

Please inquire about test conditions and ratings.

NTC Thermistors

Temperature Sensor and Compensation 0201 (0603) Size

Chip NTC Thermistors' Ni barrier termination provides excellent solderability and their unique construction offers high stability in the application's environment.

Features

1. Excellent solderability and high stability in the application's environment
2. Excellent long-term stability
3. High accuracy in resistance and B-Constant
4. Reflow soldering possible
5. NCP series are recognized by UL/cUL.
 (UL1434, File No.E137188)



Detailed are accessible from the following URL.
<https://www.murata.com/en-global/products/thermistor/ntc/ncp>

Applications

1. Temperature compensation for transistors, ICs, and crystal oscillators in mobile communications
2. Temperature sensor for rechargeable batteries

Part Number	Resistance (25°C) (ohm)	B-Constant (25-50°C) (K)	B-Constant (25-80°C) (Reference Value) (K)	B-Constant (25-85°C) (Reference Value) (K)	B-Constant (25-100°C) (Reference Value) (K)	Maximum Operating Current (25°C) (mA)	Maximum Voltage (V)	Typical Dissipation Constant (25°C) (mW/°C)
NCP03XM102□05RL	1.0k	3500 ±1%	3539	3545	3560	0.316	5	1
NCP03XM152□05RL	1.5k	3500 ±1%	3539	3545	3560	0.258	5	1
NCP03XM222□05RL	2.2k	3500 ±1%	3539	3545	3560	0.213	5	1
NCP03XM332□05RL	3.3k	3500 ±1%	3539	3545	3560	0.174	5	1
NCP03XM472□05RL	4.7k	3500 ±1%	3539	3545	3560	0.146	5	1
NCP03XH682□05RL	6.8k	3380 ±1%	3428	3434	3455	0.121	5	1
NCP03XH103F05RL	10k ±1%	3380 ±1%	3428	3434	3455	0.100	5	1
NCP03XH103□05RL	10k	3380 ±1%	3428	3434	3455	0.100	5	1
NCP03XV103□05RL	10k	3900 ±1%	3930	3934	3944	0.100	5	1
NCP03XH153□05RL	15k	3380 ±1%	3428	3434	3455	0.082	5	1
NCP03XH223F05RL	22k ±1%	3380 ±1%	3428	3434	3455	0.067	5	1
NCP03XH223□05RL	22k	3380 ±1%	3428	3434	3455	0.067	5	1
NCP03WF333□05RL	33k	4250 ±1%	4303	4311	4334	0.055	5	1
NCP03WB473F05RL	47k ±1%	4050 ±1%	4101	4108	4131	0.046	5	1
NCP03WB473□05RL	47k	4050 ±3%	4101	4108	4131	0.046	5	1
NCP03WL473□05RL	47k	4485 ±1%	4537	4543	4557	0.046	5	1
NCP03WF683F05RL	68k ±1%	4250 ±1%	4303	4311	4334	0.038	5	1
NCP03WF683□05RL	68k	4250 ±1%	4303	4311	4334	0.038	5	1
NCP03WL683□05RL	68k	4485 ±1%	4537	4543	4557	0.038	5	1
NCP03WF104F05RL	100k ±1%	4250 ±1%	4303	4311	4334	0.032	5	1
NCP03WF104□05RL	100k	4250 ±1%	4303	4311	4334	0.032	5	1
NCP03WL104□05RL	100k	4485 ±1%	4537	4543	4557	0.032	5	1
NCP03WL154□05RL	150k	4485 ±1%	4537	4543	4557	0.026	5	1
NCP03WL224□05RL	220k	4485 ±1%	4537	4543	4557	0.021	5	1
NCP03WF474F05RL	470k ±1%	4250 ±1%	4303	4311	4334	0.015	5	1

□ is filled with resistance tolerance codes (E: ±3%, J: ±5%).
 Operating Temperature Range: -40°C to +125°C

NTC Thermistors

Temperature Sensor and Compensation 0402 (1005) Size/NCP Series

Chip NTC Thermistors' Ni barrier termination provides excellent solderability and their unique construction offers high stability in the application's environment.

Features

1. Excellent solderability and high stability in the application's environment
2. Excellent long-term stability
3. High accuracy in resistance and B-Constant
4. Reflow soldering possible
5. Same B-constant in the same resistance in the two sizes (0603 size/0402 size)
Downsize is easy for design.
6. NCP series are recognized by UL/cUL.
(UL1434, File No.E137188)



Detailed are accessible from the following URL.
<https://www.murata.com/en-global/products/thermistor/ntc/ncp>

Applications

1. Temperature compensation for transistors, ICs, and crystal oscillators in mobile communications
2. Temperature sensor for rechargeable batteries
3. Temperature compensation of LCD
4. Temperature compensation in general use of electric circuits

Part Number	Resistance (25°C) (ohm)	B-Constant (25-50°C) (K)	B-Constant (25-80°C) (Reference Value) (K)	B-Constant (25-85°C) (Reference Value) (K)	B-Constant (25-100°C) (Reference Value) (K)	Maximum Operating Current (25°C) (mA)	Maximum Voltage (V)	Typical Dissipation Constant (25°C) (mW/°C)
NCP15XM221□03RC	220	3500 ±3%	3539	3545	3560	0.674	5	1
NCP15XM331□03RC	330	3500 ±3%	3539	3545	3560	0.550	5	1
NCP15XQ471□03RC	470	3650 ±2%	3688	3693	3706	0.609	5	1
NCP15XQ681□03RC	680	3650 ±3%	3688	3693	3706	0.383	5	1
NCP15XQ102□03RC	1.0k	3650 ±2%	3688	3693	3706	0.316	5	1
NCP15XW152□03RC	1.5k	3950 ±3%	3982	3987	3998	0.258	5	1
NCP15XW222□03RC	2.2k	3950 ±3%	3982	3987	3998	0.213	5	1
NCP15XW332□03RC	3.3k	3950 ±3%	3982	3987	3998	0.174	5	1
NCP15XM472□03RC	4.7k	3500 ±2%	3539	3545	3560	0.146	5	1
NCP15XW472□03RC	4.7k	3950 ±3%	3982	3987	3998	0.146	5	1
NCP15XW682□03RC	6.8k	3950 ±3%	3982	3987	3998	0.121	5	1
NCP15XH103D03RC	10k ±0.5%	3380 ±0.7%	3428	3434	3455	0.100	5	1
NCP15XH103F03RC	10k ±1%	3380 ±1%	3428	3434	3455	0.100	5	1
NCP15XH103□03RC	10k	3380 ±1%	3428	3434	3455	0.100	5	1
NCP15XV103□03RC	10k	3900 ±3%	3930	3934	3944	0.100	5	1
NCP15XW153□03RC	15k	3950 ±3%	3982	3987	3998	0.082	5	1
NCP15XW223□03RC	22k	3950 ±3%	3982	3987	3998	0.067	5	1
NCP15WL223□03RC	22k	4485 ±1%	4537	4543	4557	0.067	5	1
NCP15WB333□03RC	33k	4050 ±3%	4101	4108	4131	0.055	5	1
NCP15WL333□03RC	33k	4485 ±1%	4537	4543	4557	0.055	5	1
NCP15WB473D03RC	47k ±0.5%	4050 ±0.5%	4101	4108	4131	0.046	5	1
NCP15WB473F03RC	47k ±1%	4050 ±1%	4101	4108	4131	0.046	5	1
NCP15WB473□03RC	47k	4050 ±1%	4101	4108	4131	0.046	5	1
NCP15WL473□03RC	47k	4485 ±1%	4537	4543	4557	0.046	5	1

□ is filled with resistance tolerance codes (E: ±3%, J: ±5%).
 Operating Temperature Range: -40°C to +125°C

Continued on the following page. ↗

Continued from the preceding page. ↘

Part Number	Resistance (25°C) (ohm)	B-Constant (25-50°C) (K)	B-Constant (25-80°C) (Reference Value) (K)	B-Constant (25-85°C) (Reference Value) (K)	B-Constant (25-100°C) (Reference Value) (K)	Maximum Operating Current (25°C) (mA)	Maximum Voltage (V)	Typical Dissipation Constant (25°C) (mW/°C)
NCP15WD683□03RC	68k	4150 ±3%	4201	4209	4232	0.038	5	1
NCP15WL683□03RC	68k	4485 ±1%	4537	4543	4557	0.038	5	1
NCP15WF104D03RC	100k ±0.5%	4250 ±0.5%	4303	4311	4334	0.032	5	1
NCP15WF104F03RC	100k ±1%	4250 ±1%	4303	4311	4334	0.032	5	1
NCP15WF104□03RC	100k	4250 ±1%	4303	4311	4334	0.032	5	1
NCP15WL104□03RC	100k	4485 ±1%	4537	4543	4557	0.032	5	1
NCP15WL154□03RC	150k	4485 ±1%	4537	4543	4557	0.026	5	1
NCP15WM154□03RC	150k	4500 ±3%	4571	4582	4614	0.026	5	1
NCP15WM224□03RC	220k	4500 ±3%	4571	4582	4614	0.021	5	1
NCP15WM474□03RC	470k	4500 ±3%	4571	4582	4614	0.015	5	1

□ is filled with resistance tolerance codes (E: ±3%, J: ±5%).
 Operating Temperature Range: -40°C to +125°C

NTC Thermistors

Temperature Sensor and Compensation 0402 (1005) Size/NCU Series

Chip NTC Thermistors have Ni barrier termination, provide excellent solderability and offer high stability in environment due to unique inner construction.

This is new series, available market where request the high reliability for wide temperature sensing and compensation.

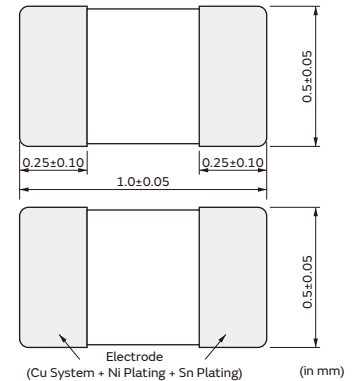

Features

1. Excellent solderability and high stability in the application's environment
2. Excellent long-term stability
3. High accuracy in resistance and B-Constant
4. Reflow soldering possible
5. Same B-constant in the same resistance in the two sizes (0603 size/0402 size)
Downsize is easy for design.
6. NCU series are recognized by UL/cUL.
(UL1434, File No.E137188)

Detailed are accessible from the following URL.
<https://www.murata.com/en-global/products/thermistor/ntc/ncu>

Applications

1. Temperature compensation for transistors, ICs, and crystal oscillators in mobile communications
2. Temperature sensor for rechargeable batteries
3. Temperature compensation of LCD
4. Temperature compensation in general use of electric circuits

Part Number	Resistance (25°C) (ohm)	B-Constant (25-50°C) (K)	B-Constant (25-80°C) (Reference Value) (K)	B-Constant (25-85°C) (Reference Value) (K)	B-Constant (25-100°C) (Reference Value) (K)	Maximum Operating Current (25°C) (mA)	Maximum Voltage (V)	Typical Dissipation Constant (25°C) (mW/°C)
NCU15XH103D60RC	10k ±0.5%	3380 ±0.7%	3428	3434	3455	0.100	5	1
NCU15XH103F60RC	10k ±1%	3380 ±1%	3428	3434	3455	0.100	5	1
NCU15XH103□60RC	10k	3380 ±1%	3428	3434	3455	0.100	5	1
NCU15WB473D60RC	47k ±0.5%	4050 ±0.5%	4101	4108	4131	0.046	5	1
NCU15WB473F60RC	47k ±1%	4050 ±1%	4101	4108	4131	0.046	5	1
NCU15WB473□60RC	47k	4050 ±1%	4101	4108	4131	0.046	5	1
NCU15WF104D60RC	100k ±0.5%	4250 ±0.5%	4303	4311	4334	0.032	5	1
NCU15WF104F60RC	100k ±1%	4250 ±1%	4303	4311	4334	0.032	5	1
NCU15WF104□60RC	100k	4250 ±1%	4303	4311	4334	0.032	5	1

□ is filled with resistance tolerance codes (E: ±3%, J: ±5%).

Operating Temperature Range: -40°C to +125°C

If there is any additionally electrical characteristics, please contact from close sales office or website.

NTC Thermistors

Temperature Sensor and Compensation 0603 (1608) Size/NCP Series

Chip NTC Thermistors' Ni barrier termination provides excellent solderability and their unique construction offers high stability in the application's environment.

Features

1. Excellent solderability and high stability in the application's environment
2. Excellent long-term stability
3. High accuracy in resistance and B-constant
4. Flow/Reflow soldering possible
5. Same B-Constant in the same resistance in the two sizes (0603 size/0402 size)
Downsize is easy for design.
6. NCP series are recognized by UL/cUL.
(UL1434, File No.E137188)



Detailed are accessible from the following URL.
<https://www.murata.com/en-global/products/thermistor/ntc/ncp>

Applications

1. Temperature compensation for transistors, ICs, and crystal oscillators in mobile communications
2. Temperature sensor for rechargeable batteries
3. Temperature compensation of LCD
4. Temperature compensation in general use of electric circuits

Part Number	Resistance (25°C) (ohm)	B-Constant (25-50°C) (K)	B-Constant (25-80°C) (Reference Value) (K)	B-Constant (25-85°C) (Reference Value) (K)	B-Constant (25-100°C) (Reference Value) (K)	Maximum Operating Current (25°C) (mA)	Maximum Voltage (V)	Typical Dissipation Constant (25°C) (mW/°C)
NCP18XM221□03RB	220	3500 ±3%	3539	3545	3560	0.674	5	1
NCP18XM331□03RB	330	3500 ±3%	3539	3545	3560	0.550	5	1
NCP18XQ471□03RB	470	3650 ±2%	3688	3693	3706	0.609	5	1
NCP18XQ681□03RB	680	3650 ±3%	3688	3693	3706	0.383	5	1
NCP18XQ102□03RB	1.0k	3650 ±2%	3688	3693	3706	0.316	5	1
NCP18XW152□03RB	1.5k	3950 ±3%	3982	3987	3998	0.258	5	1
NCP18XW222□03RB	2.2k	3950 ±3%	3982	3987	3998	0.213	5	1
NCP18XW332□03RB	3.3k	3950 ±3%	3982	3987	3998	0.174	5	1
NCP18XM472□03RB	4.7k	3500 ±2%	3539	3545	3560	0.146	5	1
NCP18XW472□03RB	4.7k	3950 ±3%	3982	3987	3998	0.146	5	1
NCP18XW682□03RB	6.8k	3950 ±3%	3982	3987	3998	0.121	5	1
NCP18XH103D03RB	10k ±0.5%	3380 ±0.7%	3428	3434	3455	0.100	5	1
NCP18XH103F03RB	10k ±1%	3380 ±1%	3428	3434	3455	0.100	5	1
NCP18XH103□03RB	10k	3380 ±1%	3428	3434	3455	0.100	5	1
NCP18XV103□03RB	10k	3900 ±3%	3930	3934	3944	0.100	5	1
NCP18XW153□03RB	15k	3950 ±3%	3982	3987	3998	0.082	5	1
NCP18XW223□03RB	22k	3950 ±3%	3982	3987	3998	0.067	5	1
NCP18WB333□03RB	33k	4050 ±3%	4101	4108	4131	0.055	5	1
NCP18WB473D03RB	47k ±0.5%	4050 ±0.5%	4101	4108	4131	0.046	5	1
NCP18WB473F10RB	47k ±1%	4050 ±1.5%	4101	4108	4131	0.046	5	1
NCP18WB473□03RB	47k	4050 ±1%	4101	4108	4131	0.046	5	1
NCP18WD683□03RB	68k	4150 ±3%	4201	4209	4232	0.038	5	1
NCP18WF104D03RB	100k ±0.5%	4200 ±0.5%	4303	4311	4334	0.032	5	1

□ is filled with resistance tolerance codes (E: ±3%, J: ±5%).
 Operating Temperature Range: -40°C to +125°C

Continued on the following page. ↗

Continued from the preceding page. ↘

Part Number	Resistance (25°C) (ohm)	B-Constant (25-50°C) (K)	B-Constant (25-80°C) (Reference Value) (K)	B-Constant (25-85°C) (Reference Value) (K)	B-Constant (25-100°C) (Reference Value) (K)	Maximum Operating Current (25°C) (mA)	Maximum Voltage (V)	Typical Dissipation Constant (25°C) (mW/°C)
NCP18WF104F12RB	100k ±1%	4200 ±1%	4303	4311	4334	0.032	5	1
NCP18WF104□03RB	100k	4250 ±2%	4303	4311	4334	0.032	5	1
NCP18WM154□03RB	150k	4500 ±3%	4571	4582	4614	0.026	5	1
NCP18WM224□03RB	220k	4500 ±3%	4571	4582	4614	0.021	5	1
NCP18WM474□03RB	470k	4500 ±3%	4571	4582	4614	0.015	5	1

□ is filled with resistance tolerance codes (E: ±3%, J: ±5%).

Operating Temperature Range: -40°C to +125°C

NTC Thermistors

Temperature Sensor and Compensation 0603 (1608) Size/NCU Series

Chip NTC Thermistors have Ni barrier termination, provide excellent solderability and offer high stability in environment due to unique inner construction.

This is new series, available market where request the high reliability for wide temperature sensing and compensation.

Features

1. Excellent solderability and high stability in the application's environment
2. Excellent long-term stability
3. High accuracy in resistance and B-constant
4. Flow/Reflow soldering possible
5. Same B-Constant in the same resistance in the two sizes (0603 size/0402 size)
Downsize is easy for design.
6. NCU series are recognized by UL/cUL.
(UL1434, File No.E137188)



Detailed are accessible from the following URL.
<https://www.murata.com/en-global/products/thermistor/ntc/ncu>

Applications

1. Temperature compensation for transistors, ICs, and crystal oscillators in mobile communications
2. Temperature sensor for rechargeable batteries
3. Temperature compensation of LCD
4. Temperature compensation in general use of electric circuits

Part Number	Resistance (25°C) (ohm)	B-Constant (25-50°C) (K)	B-Constant (25-80°C) (Reference Value) (K)	B-Constant (25-85°C) (Reference Value) (K)	B-Constant (25-100°C) (Reference Value) (K)	Maximum Operating Current (25°C) (mA)	Maximum Voltage (V)	Typical Dissipation Constant (25°C) (mW/°C)
NCU18XH103D60RB	10k ±0.5%	3380 ±0.7%	3428	3434	3455	0.100	5	1
NCU18XH103F60RB	10k ±1%	3380 ±1%	3428	3434	3455	0.100	5	1
NCU18XH103□60RB	10k	3380 ±1%	3428	3434	3455	0.100	5	1
NCU18WB473D60RB	47k ±0.5%	4050 ±0.5%	4101	4108	4131	0.046	5	1
NCU18WB473F60RB	47k ±1%	4050 ±1%	4101	4108	4131	0.046	5	1
NCU18WB473□60RB	47k	4050 ±1%	4101	4108	4131	0.046	5	1
NCU18WF104D60RB	100k ±0.5%	4250 ±0.5%	4303	4311	4334	0.032	5	1
NCU18WF104F60RB	100k ±1%	4250 ±1%	4303	4311	4334	0.032	5	1
NCU18WF104□60RB	100k	4250 ±2%	4303	4311	4334	0.032	5	1
NCU18WM154□60RB	150k	4500 ±3%	4571	4582	4614	0.026	5	1
NCU18WM224□60RB	220k	4500 ±3%	4571	4582	4614	0.021	5	1
NCU18WM474□60RB	470k	4500 ±3%	4571	4582	4614	0.015	5	1

□ is filled with resistance tolerance codes (E: ±3%, J: ±5%).

Operating Temperature Range: -40°C to +125°C

If there is any additionally electrical characteristics, please contact from close sales office or website.

Temperature Sensor and Compensation Chip Type Standard Land Pattern Dimensions



Part Number	Soldering Methods	Dimensions (mm)			
		Chip (LxW)	a	b	c
NCP03	Reflow Soldering	0.6x0.3	0.25	0.3	0.3
NCP15	Reflow Soldering	1.0x0.5	0.4	0.4-0.5	0.5
NCU15	Reflow Soldering	1.0x0.5	0.6	0.4-0.5	0.5
NCP18	Flow Soldering	1.6x0.8	0.6-1.0	0.8-0.9	0.6-0.8
	Reflow Soldering		0.6-0.8	0.6-0.7	0.6-0.8
NCU18	Flow Soldering	1.6x0.8	0.6-1.2	0.8-0.9	0.6-0.8
	Reflow Soldering		0.6-1.2	0.6-0.7	0.6-0.8

Temperature Sensor and Compensation Chip Type Temperature Characteristics (Center Value)

Part Number	NCP□□XM221	NCP□□XM331	NCP□□XQ471	NCP□□XQ681	NCP□□XM102	NCP□□XQ102	NCP□□XM152	NCP□□XW152
Resistance	220Ω	330Ω	470Ω	680Ω	1.0kΩ	1.0kΩ	1.5kΩ	1.5kΩ
B-Constant	3500K	3500K	3650K	3650K	3500K	3650K	3500K	3950K
Temp. (°C)	Resistance (Ω)	Resistance (Ω)	Resistance (Ω)	Resistance (Ω)	Resistance (kΩ)	Resistance (kΩ)	Resistance (kΩ)	Resistance (kΩ)
-40	4947.904	7421.856	11822.473	17104.854	21.266	25.154	31.899	51.791
-35	3703.755	5555.632	8767.745	12685.248	16.150	18.655	24.225	37.172
-30	2798.873	4198.309	6570.224	9505.855	12.347	13.979	18.520	27.005
-25	2135.887	3203.831	4971.784	7193.219	9.503	10.578	14.255	19.843
-20	1645.037	2467.555	3796.933	5493.436	7.365	8.079	11.047	14.728
-15	1278.034	1917.051	2923.400	4229.599	5.747	6.220	8.621	11.044
-10	1000.620	1500.930	2269.599	3283.675	4.516	4.829	6.773	8.362
-5	789.612	1184.418	1775.225	2568.411	3.572	3.777	5.358	6.389
0	627.752	941.628	1399.050	2024.158	2.844	2.977	4.266	4.922
5	502.474	753.711	1110.220	1606.275	2.280	2.362	3.419	3.825
10	405.010	607.514	887.257	1283.691	1.839	1.888	2.758	2.994
15	328.480	492.720	713.463	1032.245	1.492	1.518	2.238	2.361
20	268.044	402.066	577.375	835.351	1.218	1.229	1.827	1.876
25	220.000	330.000	470.000	680.000	1.000	1.000	1.500	1.500
30	181.576	272.365	384.800	556.733	0.825	0.819	1.238	1.207
35	150.668	226.002	316.757	458.287	0.685	0.674	1.027	0.978
40	125.681	188.521	262.177	379.320	0.571	0.558	0.857	0.797
45	105.336	158.004	218.069	315.504	0.479	0.464	0.718	0.653
50	88.717	133.076	182.297	263.749	0.403	0.388	0.605	0.538
55	75.059	112.588	153.150	221.579	0.341	0.326	0.512	0.446
60	63.777	95.666	129.249	186.998	0.290	0.275	0.435	0.371
65	54.415	81.622	109.551	158.499	0.247	0.233	0.371	0.317
70	46.631	69.946	93.281	134.960	0.212	0.199	0.318	0.261
75	40.115	60.172	79.750	115.383	0.182	0.170	0.274	0.221
80	34.637	51.955	68.446	99.029	0.157	0.146	0.236	0.187
85	30.013	45.019	58.996	85.356	0.136	0.126	0.205	0.160
90	26.110	39.165	51.036	73.839	0.119	0.109	0.178	0.137
95	22.790	34.186	44.332	64.140	0.104	0.094	0.155	0.117
100	19.957	29.935	38.640	55.905	0.091	0.082	0.136	0.101
105	17.541	26.312	33.790	48.888	0.080	0.072	0.120	0.088
110	15.453	23.180	29.664	42.918	0.070	0.063	0.105	0.076
115	13.663	20.494	26.123	37.795	0.062	0.056	0.093	0.067
120	12.114	18.171	23.091	33.409	0.055	0.049	0.083	0.058
125	10.778	16.168	20.472	29.618	0.049	0.044	0.074	0.051

Part Number	NCP□□XM222	NCP□□XW222	NCP□□XM332	NCP□□XW332	NCP□□XM472	NCP□□XW472	NCP□□XH682	NCP□□XW682
Resistance	2.2kΩ	2.2kΩ	3.3kΩ	3.3kΩ	4.7kΩ	4.7kΩ	6.8kΩ	6.8kΩ
B-Constant	3500K	3950K	3500K	3950K	3500K	3950K	3380K	3950K
Temp. (°C)	Resistance (kΩ)	Resistance (kΩ)	Resistance (kΩ)	Resistance (kΩ)	Resistance (kΩ)	Resistance (kΩ)	Resistance (kΩ)	Resistance (kΩ)
-40	46.786	75.961	70.179	113.941	105.705	162.279	133.043	234.787
-35	35.530	54.520	53.295	81.779	79.126	116.474	100.756	168.515
-30	27.162	39.607	40.743	59.411	59.794	84.615	77.076	122.422
-25	20.907	29.103	31.360	43.654	45.630	62.173	59.540	89.953
-20	16.203	21.601	24.304	32.401	35.144	46.147	46.401	66.766
-15	12.644	16.198	18.966	24.297	27.303	34.604	36.482	50.066
-10	9.934	12.264	14.901	18.396	21.377	26.200	28.904	37.906
-5	7.858	9.370	11.787	14.055	16.869	20.018	23.047	28.963
0	6.257	7.219	9.386	10.829	13.411	15.423	18.509	22.313
5	5.015	5.609	7.523	8.414	10.735	11.984	14.974	17.338
10	4.045	4.391	6.067	6.586	8.653	9.380	12.189	13.571
15	3.283	3.463	4.924	5.195	7.018	7.399	9.978	10.705
20	2.680	2.751	4.019	4.126	5.726	5.877	8.215	8.503
25	2.200	2.200	3.300	3.300	4.700	4.700	6.800	6.800
30	1.816	1.771	2.724	2.656	3.879	3.783	5.654	5.474
35	1.507	1.434	2.260	2.152	3.219	3.064	4.725	4.434
40	1.257	1.169	1.885	1.753	2.685	2.497	3.967	3.613
45	1.053	0.958	1.580	1.437	2.250	2.046	3.344	2.961
50	0.887	0.789	1.331	1.184	1.895	1.686	2.829	2.440
55	0.751	0.654	1.126	0.981	1.604	1.397	2.404	2.022
60	0.638	0.545	0.957	0.817	1.363	1.164	2.050	1.683
65	0.544	0.456	0.816	0.684	1.163	0.974	1.759	1.409
70	0.466	0.383	0.700	0.575	0.996	0.819	1.515	1.185
75	0.401	0.324	0.602	0.486	0.857	0.692	1.309	1.001
80	0.346	0.275	0.520	0.412	0.740	0.587	1.135	0.849
85	0.300	0.234	0.450	0.351	0.641	0.500	0.988	0.724
90	0.261	0.200	0.392	0.301	0.558	0.428	0.862	0.620
95	0.228	0.172	0.342	0.258	0.487	0.368	0.755	0.532
100	0.200	0.149	0.299	0.223	0.426	0.318	0.662	0.459
105	0.175	0.129	0.263	0.193	0.375	0.275	0.583	0.398
110	0.155	0.112	0.232	0.168	0.330	0.239	0.515	0.346
115	0.137	0.098	0.205	0.146	0.292	0.208	0.457	0.302
120	0.121	0.085	0.182	0.128	0.259	0.182	0.406	0.264
125	0.108	0.075	0.162	0.113	0.230	0.160	0.361	0.232

Continued on the following page. ↗

Temperature Sensor and Compensation Chip Type Temperature Characteristics (Center Value)

Continued from the preceding page. ↘

Part Number	NC□□XH103D	NC□□XH103	NCP□□XV103	NCP□□XH153	NCP□□XW153	NCP□□XH223	NCP□□XW223	NCP□□WL223
Resistance	10kΩ±0.5%	10kΩ	10kΩ	15kΩ	15kΩ	22kΩ	22kΩ	22kΩ
B-Constant	3380K	3380K	3900K	3380K	3950K	3380K	3950K	4485K
Temp. (°C)	Resistance (kΩ)	Resistance (kΩ)	Resistance (kΩ)	Resistance (kΩ)	Resistance (kΩ)	Resistance (kΩ)	Resistance (kΩ)	Resistance (kΩ)
-40	197.390	195.652	328.996	293.478	517.912	430.434	759.605	1073.436
-35	149.390	148.171	237.387	222.256	371.724	325.976	545.196	753.900
-30	114.340	113.347	173.185	170.021	270.048	249.364	396.070	535.073
-25	88.381	87.559	127.773	131.338	198.426	192.629	291.025	383.590
-20	68.915	68.237	95.327	102.355	147.278	150.121	216.008	277.643
-15	54.166	53.650	71.746	80.474	110.439	118.029	161.977	202.813
-10	42.889	42.506	54.564	63.759	83.617	93.514	122.638	149.462
-5	34.196	33.892	41.813	50.838	63.888	74.563	93.702	111.082
0	27.445	27.219	32.330	40.828	49.221	59.881	72.191	83.233
5	22.165	22.021	25.194	33.032	38.245	48.446	56.093	62.858
10	18.010	17.926	19.785	26.888	29.936	39.436	43.907	47.831
15	14.720	14.674	15.651	22.010	23.613	32.282	34.633	36.664
20	12.099	12.081	12.468	18.121	18.756	26.577	27.509	28.304
25	10.000	10.000	10.000	15.000	15.000	22.000	22.000	22.000
30	8.309	8.315	8.072	12.472	12.074	18.292	17.709	17.214
35	6.939	6.948	6.556	10.422	9.780	15.285	14.344	13.557
40	5.824	5.834	5.356	8.751	7.969	12.834	11.688	10.744
45	4.911	4.917	4.401	7.375	6.531	10.817	9.578	8.566
50	4.160	4.161	3.635	6.241	5.382	9.154	7.894	6.871
55	3.539	3.535	3.019	5.302	4.459	7.777	6.540	5.544
60	3.024	3.014	2.521	4.521	3.713	6.631	5.446	4.498
65	2.593	2.586	2.115	3.879	3.108	5.690	4.559	3.669
70	2.233	2.228	1.781	3.341	2.613	4.901	3.832	3.009
75	1.929	1.925	1.509	2.887	2.208	4.234	3.239	2.479
80	1.673	1.669	1.284	2.503	1.873	3.671	2.748	2.052
85	1.455	1.452	1.097	2.178	1.597	3.195	2.342	1.707
90	1.270	1.268	0.941	1.902	1.367	2.790	2.004	1.426
95	1.112	1.110	0.810	1.664	1.174	2.441	1.722	1.196
100	0.976	0.974	0.701	1.461	1.013	2.142	1.486	1.008
105	0.860	0.858	0.608	1.287	0.878	1.888	1.287	0.852
110	0.759	0.758	0.530	1.137	0.763	1.668	1.119	0.724
115	0.673	0.672	0.463	1.007	0.665	1.477	0.975	0.617
120	0.598	0.596	0.406	0.895	0.582	1.312	0.854	0.528
125	0.532	0.531	0.358	0.797	0.511	1.169	0.750	0.454

Part Number	NCP□□WB333	NCP□□WF333	NCP□□WL333	NC□□WB473D	NC□□WB473	NCP□□WL473	NCP□□WD683	NCP□□WF683
Resistance	33kΩ	33kΩ	33kΩ	47kΩ±0.5%	47kΩ	47kΩ	68kΩ	68kΩ
B-Constant	4050K	4250K	4485K	4050K	4050K	4485K	4150K	4250K
Temp. (°C)	Resistance (kΩ)	Resistance (kΩ)	Resistance (kΩ)	Resistance (kΩ)	Resistance (kΩ)	Resistance (kΩ)	Resistance (kΩ)	Resistance (kΩ)
-40	1227.263	1451.049	1610.154	1690.586	1747.920	2293.249	2735.359	2990.041
-35	874.449	1019.238	1130.850	1215.318	1245.428	1610.605	1937.391	2100.247
-30	630.851	725.084	802.609	882.908	898.485	1143.110	1389.345	1494.113
-25	460.457	522.021	575.385	647.911	655.802	819.487	1008.014	1075.679
-20	339.797	379.842	416.464	480.069	483.954	593.146	738.978	782.705
-15	253.363	279.371	304.219	359.009	360.850	433.281	547.456	575.674
-10	190.766	207.566	224.193	270.868	271.697	319.305	409.600	427.712
-5	144.964	155.639	166.623	206.113	206.463	237.312	309.217	320.710
0	111.087	117.814	124.850	158.126	158.214	177.816	235.606	242.768
5	85.842	89.925	94.287	122.267	122.259	134.287	180.980	185.300
10	66.861	69.204	71.747	95.256	95.227	102.184	140.139	142.603
15	52.470	53.675	54.996	74.754	74.730	78.327	109.344	110.602
20	41.471	41.937	42.455	59.075	59.065	60.467	85.929	86.415
25	33.000	33.000	33.000	47.000	47.000	47.000	68.000	68.000
30	26.430	26.143	25.822	37.636	37.643	36.776	54.167	53.871
35	21.298	20.845	20.335	30.326	30.334	28.962	43.421	42.954
40	17.266	16.723	16.115	24.583	24.591	22.952	35.016	34.460
45	14.076	13.498	12.849	20.043	20.048	18.301	28.406	27.814
50	11.538	10.954	10.306	16.433	16.433	14.679	23.166	22.572
55	9.506	8.940	8.317	13.545	13.539	11.845	18.997	18.422
60	7.870	7.334	6.748	11.223	11.209	9.610	15.657	15.113
65	6.549	6.046	5.504	9.345	9.328	7.839	12.967	12.459
70	5.475	5.011	4.513	7.818	7.798	6.427	10.794	10.325
75	4.595	4.170	3.718	6.571	6.544	5.296	9.021	8.592
80	3.874	3.487	3.078	5.548	5.518	4.384	7.575	7.185
85	3.282	2.928	2.560	4.704	4.674	3.646	6.387	6.033
90	2.789	2.469	2.139	4.004	3.972	3.046	5.407	5.087
95	2.379	2.091	1.794	3.422	3.388	2.555	4.598	4.309
100	2.038	1.777	1.511	2.936	2.902	2.152	3.922	3.661
105	1.751	1.516	1.278	2.528	2.494	1.820	3.359	3.124
110	1.509	1.298	1.085	2.184	2.150	1.546	2.887	2.675
115	1.306	1.116	0.925	1.893	1.860	1.318	2.489	2.299
120	1.134	0.962	0.792	1.646	1.615	1.128	2.155	1.983
125	0.987	0.832	0.681	1.436	1.406	0.970	1.870	1.715

Continued on the following page. ↗

Temperature Sensor and Compensation Chip Type Temperature Characteristics (Center Value)

Continued from the preceding page. ↘

Part Number	NCP□□WL683	NC□□WF104D	NC□□WF104	NCP□□WL104	NCP□□WL154	NC□□WM154	NCP□□WL224	NC□□WM224
Resistance	68kΩ	100kΩ±0.5%	100kΩ	100kΩ	150kΩ	150kΩ	220kΩ	220kΩ
B-Constant	4485K	4250K	4250K	4485K	4485K	4500K	4485K	4500K
Temp. (°C)	Resistance (kΩ)	Resistance (kΩ)	Resistance (kΩ)	Resistance (kΩ)	Resistance (kΩ)	Resistance (kΩ)	Resistance (kΩ)	Resistance (kΩ)
-40	3317.893	4221.283	4397.119	4879.254	7318.881	7899.466	10734.358	11585.884
-35	2330.237	2995.044	3088.599	3426.818	5140.228	5466.118	7539.001	8016.973
-30	1653.862	2146.996	2197.225	2432.149	3648.224	3834.499	5350.729	5623.931
-25	1185.641	1554.599	1581.881	1743.590	2615.385	2720.523	3835.898	3990.100
-20	858.168	1136.690	1151.037	1262.012	1893.018	1951.216	2776.427	2861.784
-15	626.875	839.019	846.579	921.875	1382.813	1415.565	2028.126	2076.162
-10	461.974	624.987	628.988	679.373	1019.059	1036.984	1494.620	1520.909
-5	343.345	469.678	471.632	504.919	757.379	767.079	1110.822	1125.049
0	257.266	355.975	357.012	378.333	567.499	572.667	832.332	839.912
5	194.287	272.011	272.500	285.717	428.575	431.264	628.577	632.521
10	147.841	209.489	209.710	217.414	326.121	327.405	478.310	480.194
15	113.325	162.559	162.651	166.654	249.981	250.538	366.639	367.455
20	87.484	127.057	127.080	128.653	192.979	193.166	283.036	283.310
25	68.000	100.000	100.000	100.000	150.000	150.000	220.000	220.000
30	53.208	79.222	79.222	78.247	117.370	117.281	172.143	172.012
35	41.903	63.167	63.167	61.622	92.433	92.293	135.569	135.364
40	33.208	50.677	50.677	48.835	73.252	73.090	107.436	107.198
45	26.477	40.904	40.904	38.937	58.406	58.240	85.662	85.419
50	21.237	33.195	33.195	31.231	46.846	46.665	68.708	68.441
55	17.137	27.091	27.091	25.202	37.803	37.605	55.444	55.153
60	13.904	22.224	22.224	20.448	30.671	30.453	44.984	44.665
65	11.342	18.323	18.323	16.679	25.018	24.804	36.694	36.379
70	9.299	15.184	15.184	13.675	20.513	20.293	30.085	29.763
75	7.662	12.635	12.635	11.268	16.902	16.679	24.789	24.462
80	6.343	10.566	10.566	9.329	13.993	13.776	20.523	20.205
85	5.276	8.873	8.873	7.758	11.638	11.428	17.068	16.761
90	4.407	7.481	7.481	6.481	9.721	9.520	14.258	13.962
95	3.697	6.337	6.337	5.437	8.155	7.966	11.961	11.684
100	3.114	5.384	5.384	4.580	6.869	6.688	10.075	9.809
105	2.634	4.594	4.594	3.873	5.810	5.639	8.521	8.270
110	2.236	3.934	3.934	3.289	4.933	4.772	7.236	6.998
115	1.907	3.380	3.380	2.804	4.206	4.052	6.169	5.942
120	1.632	2.916	2.916	2.400	3.601	3.454	5.281	5.067
125	1.403	2.522	2.522	2.064	3.096	2.955	4.540	4.334

Part Number	NCP□□WF474	NC□□WM474
Resistance	470kΩ±1%	470kΩ
B-Constant	4250K	4500K
Temp. (°C)	Resistance (kΩ)	Resistance (kΩ)
-40	18632.4186	24751.661
-35	13322.1161	17127.169
-30	9596.7223	12014.762
-25	7012.1677	8524.305
-20	5148.6454	6113.811
-15	3837.2457	4435.437
-10	2870.6987	3249.216
-5	2177.2734	2403.515
0	1657.5649	1794.358
5	1271.5627	1351.294
10	980.9354	1025.870
15	762.8640	785.018
20	596.7998	605.252
25	470.0000	470.000
30	372.5499	367.480
35	297.1820	289.186
40	238.3762	229.014
45	192.4150	182.485
50	156.0147	146.215
55	127.2622	117.828
60	104.1000	95.420
65	85.7325	77.718
70	70.8958	63.584
75	58.9516	52.260
80	49.1468	43.166
85	41.1989	35.808
90	34.6905	29.828
95	29.3049	24.961
100	24.8835	20.955
105	21.2079	17.668
110	18.1119	14.951
115	15.5330	12.695
120	13.3419	10.824
125	11.5013	9.259

Temperature Sensor and Compensation Chip Type ⚠Caution/Notice

⚠Caution (Storage and Operating Conditions)

This product is designed for application in an ordinary environment (normal room temperature, humidity and atmospheric pressure).

Do not use under the following conditions because all of these factors can deteriorate the product characteristics or cause failures and burn-out.

1. Corrosive gas or deoxidizing gas
(Chlorine gas, Hydrogen sulfide gas, Ammonia gas, Sulfuric acid gas, Nitric oxide gas, etc.)

2. Volatile or flammable gas
3. Dusty conditions
4. Under vacuum, or under high or low pressure
5. Wet or humid locations
6. Places with salt water, oils, chemical liquids or organic solvents
7. Strong vibrations
8. Other places where similar hazardous conditions exist

⚠Caution (Others)

Be sure to provide an appropriate fail-safe function on your product to prevent secondary damage that may be caused by the abnormal function or the failure of our product.

Notice (Storage and Operating Conditions)

To keep the solderability of the product from degrading, the following storage conditions are recommended.

1. Storage condition:
Temperature -10 to +40°C
Humidity less than 75%RH (not dewing condition)
2. Storage term:
Use this product within 6 months after delivery by first-in and first-out stocking system.
3. Storage place:
Do not store this product in corrosive gas (Sulfuric acid gas, Chlorine gas, etc.) or in direct sunlight.

Notice (Rating)

Use this product within the specified temperature range.

Higher temperature may cause deterioration of the characteristics or the material quality of this product.

Notice (Handling)

The ceramic of this product is fragile, and care must be taken not to load an excessive press-force or to cause a shock at handling.

Such forces may cause cracking or chipping.

Temperature Sensor and Compensation Chip Type ⚠️Caution/Notice

Notice (Soldering and Mounting)

1. Mounting Position

Choose a mounting position that minimizes the stress imposed on the chip during flexing or bending of the board.

Component Direction

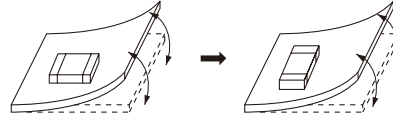

Locate this product horizontal to the direction in which stress acts.

Mounting Close to Board Separation Line

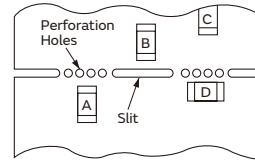

Keep this product on the PC Board away from the Separation Line.
 Worst ← A-C-B-D → Better

2. Allowable Soldering Temperature and Time

- Solder within the temperature and time combinations indicated by the slanted lines in the following graphs.
- Excessive soldering conditions may cause dissolution of metallization or deterioration of solder-wetting on the external electrode.
- In case of repeated soldering, the accumulated soldering time should be within the range shown in the figure below. (For example, Reflow peak temperature: 260°C, twice → The total accumulated soldering time at 260°C is within 30sec.)

NCP03/15 Series, NCU15 Series

Allowable Reflow Soldering Temp. and Time



NCP18 Series, NCU18 Series

Allowable Flow Soldering Temp. and Time



Allowable Reflow Soldering Temp. and Time



Continued on the following page. ↗

Temperature Sensor and Compensation Chip Type ⚠️Caution/Notice

Continued from the preceding page. ↘

3. Recommended Temperature Profile for Soldering

- (a) Insufficient preheating may cause a crack on the ceramic body. The difference between preheating temperature and maximum temperature in the profile shall be 100 °C.
 (b) Rapid cooling by dipping in solvent or by other means is not recommended.

* In case of repeated soldering, the accumulated soldering time should be within the range shown in the figure of section 2.

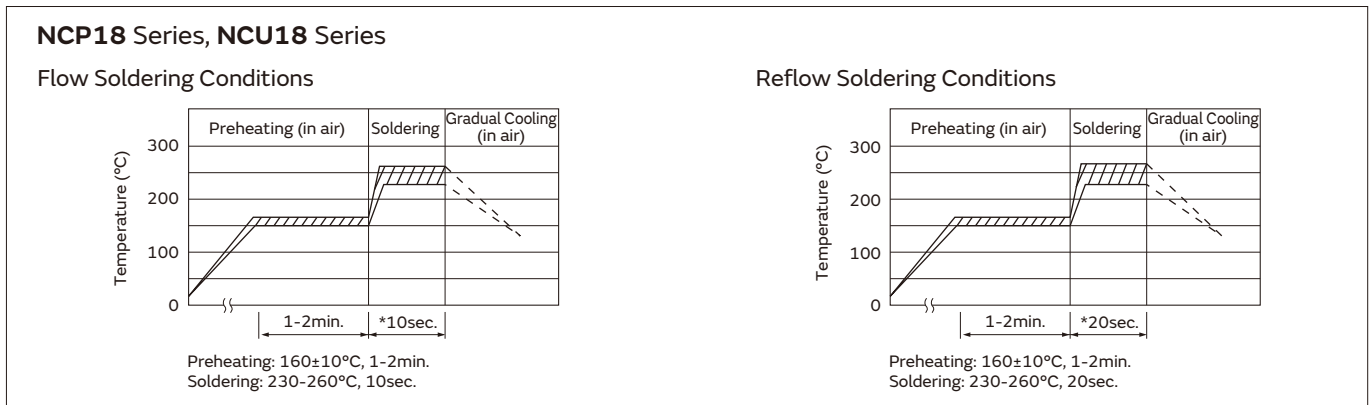
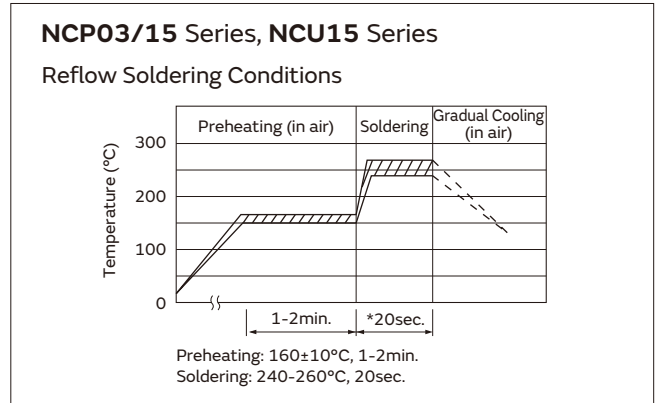

4. Solder and Flux

(1) Solder and Paste

(a) Reflow Soldering: NCP03/15/18 Series, NCU15/18 Series

For your reference, we use the solder paste below for any internal tests of this product.

- M705-GRM360-K2-V (Sn:Ag:Cu=96.5wt%:3.0wt%:0.5wt%)
 (Manufactured by Senju Metal Industry Co., Ltd.)

(b) Flow Soldering: NCP18 Series, NCU18 Series

We use the solder paste below for any internal tests of this product.

- Sn:Ag:Cu=96.5wt%:3.0wt%:0.5wt%

(2) Flux

Use rosin type flux in the soldering process.

If the flux listed below is used, some problems might be caused in the product characteristics and reliability.

Please do not use the following flux.

- Strong acidic flux (with halide content exceeding 0.1wt%).
- Water-soluble flux
 (*Water-soluble flux can be defined as non-rosin type flux including wash-type flux and non-wash-type flux.)

5. Cleaning Conditions

For removing the flux after soldering, observe the following points in order to avoid deterioration of the characteristics or any change of the external electrodes' quality.

- Please keep mounted parts and a substrate from an occurrence of resonance in ultrasonic cleaning.
- Please do not clean the products in the case of using a non-wash-type flux.

	NCP03/15, NCU15	NCP18, NCU18
Solvent	Isopropyl Alcohol	Isopropyl Alcohol
Dipping Cleaning	Less than 5min. at room temp. or less than 2min. at 40°C max.	Less than 5min. at room temp. or less than 2min. at 40°C max.
Ultrasonic Cleaning	Less than 5min. and 20W/ℓ Frequency of 28kHz to 40kHz	Less than 1min. and 20W/ℓ Frequency of several 10kHz to 100kHz

6. Drying

After cleaning, promptly dry this product.

Continued on the following page. ↗

Temperature Sensor and Compensation Chip Type ⚠️Caution/Notice

Continued from the preceding page. ↘

7. Printing Conditions of Solder Paste

- The amount of solder is critical. Standard height of fillet is shown in the table below.
- Too much solder may cause mechanical stress, resulting in cracking, mechanical and/or electronic damage.

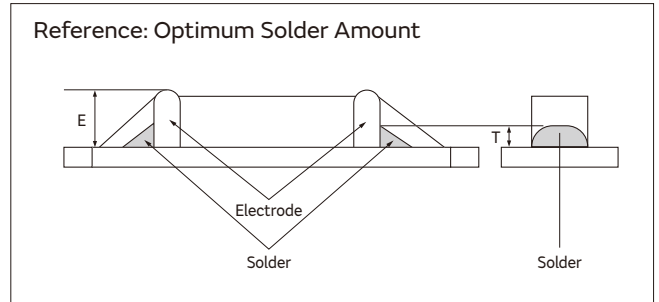

Part Number	Solder Paste Thickness	T
NCP03	100μm	$1/3E \leq T \leq E$
NCP15, NCU15	150μm	$1/3E \leq T \leq E$
NCP18, NCU18	200μm	$0.2\text{mm} \leq T \leq E$

8. Adhesive Application and Curing

- Thin or insufficient adhesive may result in loose component contact with land during flow soldering.
- Low viscosity adhesive causes chips to slip after mounting.

Temperature Sensor and Compensation Chip Type Package

Minimum Quantity Guide

Part Number	Quantity (pcs.)	
	Paper Tape	Embossed Tape
NCP03	15,000	-
NCP15, NCU15	10,000	
NCP18, NCU18	4,000	

Tape Carrier Packaging

1. Dimensions of Reel



2. Taping Method

- (1) A tape in a reel contains Leader unit and Trailer unit where products are not packed. (Please refer to the figure at the right.)
- (2) The top and base tapes or plastic and cover tape are not stuck at the first five pitches minimum.
- (3) A label should be attached on the reel. (MURATA's part number, inspection number and quantity should be marked on the label.)
- (4) Taping reels are packed in a package.

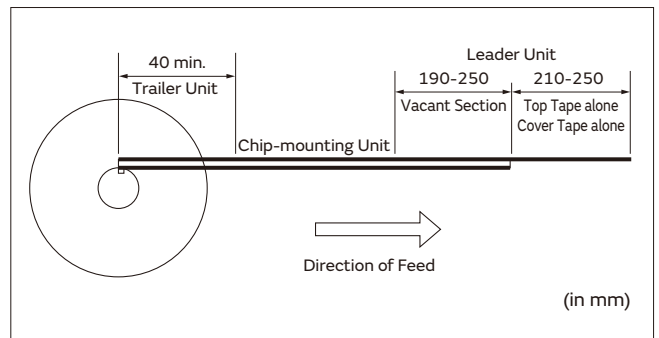

Continued on the following page. ↗

Temperature Sensor and Compensation Chip Type Package

Continued from the preceding page. ↘

3. Paper Tape (NCP03/15/18 Series, NCU15/18 Series)



(in mm)

(1) Other Conditions

(a) Packaging

Products are packaged in the cavity of the base tape and sealed by a top tape and bottom tape.

(b) Tape

The top tape and bottom tape have no joints and products are packaged and sealed in the cavity of the base tape, continuously.

(2) Peeling Force of Top Tape

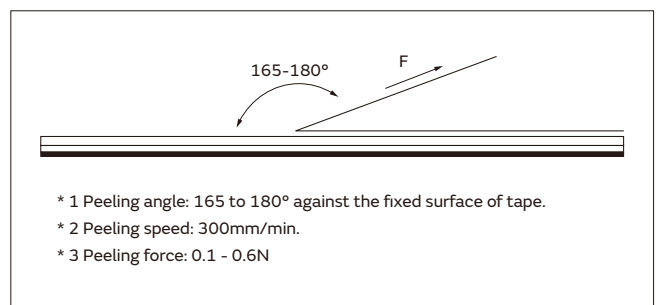

(3) Pull Strength

Pull strength of top tape is specified at 10N minimum.

Pull strength of bottom tape should be specified 5N minimum.

NTC Thermistors

Temperature Sensor Thermo String Cooper Wire Type

This product is a small flexible lead type NTC Thermistor with a small head and a thin lead wire.

Features

1. This small and highly accurate NTC Thermistor provides extremely precise temperature sensing.
2. The small sensing head and thin lead wire deliver temperature sensing in a narrow space.
3. Flexibility and a wide variety of lengths (60mm to 150mm) enable the design of flexible temperature sensing architectures.
4. This product is compatible with our 0402 (EIA) size chip Thermistor.
5. Excellent long-term stability
6. This is a halogen free product. *
 * Cl= max.900ppm, Br=max.900ppm and Cl+Br=max.1500ppm
7. NXFT series are recognized by UL/cUL. (UL1434, File No.E137188).

Applications

1. Temperature compensation for transistors, ICs, and crystal oscillators in mobile communications
2. Temperature sensor for rechargeable batteries
3. Temperature compensation of LCD
4. Temperature compensation in general use of electric circuits



NXFT15_1B Type (twist)



NXFT15_2B Type (without twist)

Detailed are accessible from the following URL.
<https://www.murata.com/en-global/products/thermistor/ntc/nxf>

Part Number	Resistance (25°C) (ohm)	B-Constant (25-50°C) (K)	B-Constant (25-80°C) (Reference Value) (K)	B-Constant (25-85°C) (Reference Value) (K)	B-Constant (25-100°C) (Reference Value) (K)	Maximum Operating Current (25°C) (mA)	Rated Electric Power (25°C) (mW)	Typical Dissipation Constant (25°C) (mW/°C)	Thermal Time Constant (25°C) (s)
NXFT15XM202EA□B□□□	2k±3%	3500±1%	3539	3545	3560	0.27	7.5	1.5	4
NXFT15XV302FA□B□□□	3k±1%	3936±1%	3971	3977	3989	0.22	7.5	1.5	4
NXFT15XH103FA□B□□□	10k±1%	3380±1%	3428	3434	3455	0.12	7.5	1.5	4
NXFT15XV103FA□B□□□	10k±1%	3936±1%	3971	3977	3989	0.12	7.5	1.5	4
NXFT15WB473FA□B□□□	47k±1%	4050±1%	4101	4108	4131	0.06	7.5	1.5	4
NXFT15WF104FA□B□□□	100k±1%	4250±1%	4303	4311	4334	0.04	7.5	1.5	4

□ is filled with lead shape (1: twist, 2: without twist).

□□□ is filled with Total-length codes. (60 to 150mm interval 10mm, ex. 060=60mm)

Maximum Operating Current rises Thermistor's temperature by 0.1°C

Rated Electric Power shows the required electric power that the thermistor's temperature rise to 30°C by self-heating, at ambient temperature of 25 °C.

Operating Temperature Range: -40°C to +125°C

NTC Thermistors

Temperature Sensor Thermo String Nickel Copper Wire Type

This product is a small flexible lead type NTC Thermistor with a small head and a thin lead wire.

Features

1. This small and highly accurate NTC Thermistor provides extremely precise temperature sensing. Nickel Copper Wire Type has high thermal response than the Cooper Wire Type.
2. The small sensing head and thin lead wire deliver temperature sensing in a narrow space.
3. Flexibility and a wide variety of lengths (21mm to 50mm) enable the design of flexible temperature sensing architectures.
4. This product is compatible with our 0402 (EIA) size chip Thermistor.
5. Excellent long-term stability
6. This is a halogen free product. *
 * Cl= max.900ppm, Br=max.900ppm and
 Cl+Br=max.1500ppm
7. NXFT series are recognized by UL/cUL.
 (UL1434, File No.E137188).



Detailed are accessible from the following URL.
<https://www.murata.com/en-global/products/thermistor/ntc/nxf>

Applications

1. Temperature compensation for transistors, ICs, and crystal oscillators in mobile communications
2. Temperature sensor for rechargeable batteries
3. Temperature compensation of LCD
4. Temperature compensation in general use of electric circuits

Part Number	Resistance (25°C) (ohm)	B-Constant (25-50°C) (K)	B-Constant (25-80°C) (Reference Value) (K)	B-Constant (25-85°C) (Reference Value) (K)	B-Constant (25-100°C) (Reference Value) (K)	Maximum Operating Current (25°C) (mA)	Rated Electric Power (25°C) (mW)	Typical Dissipation Constant (25°C) (mW/°C)	Thermal Time Constant (25°C) (s)
NXFT15XV302FEAB□□□	3k±1%	3936±1%	3971	3977	3989	0.14	3	0.6	3
NXFT15XV502FEAB□□□	5k±1%	3936±1%	3971	3977	3989	0.11	3	0.6	3
NXFT15XH103FEAB□□□	10k±1%	3380±1%	3428	3434	3455	0.077	3	0.6	3
NXFT15XV103FEAB□□□	10k±1%	3936±1%	3971	3977	3989	0.077	3	0.6	3
NXFT15WB473FEAB□□□	47k±1%	4050±1%	4101	4108	4131	0.036	3	0.6	3
NXFT15WF104FEAB□□□	100k±1%	4250±1%	4303	4311	4334	0.024	3	0.6	3

□□□ is filled with Total-length codes. (21mm, 25 to 50mm interval 5mm, ex. 050=50mm)

Maximum Operating Current rises Thermistor's temperature by 0.1°C

Rated Electric Power shows the required electric power that the thermistor's temperature rise to 30°C by self-heating, at ambient temperature of 25 °C.

Operating Temperature Range: -40°C to +125°C

Temperature Sensor Thermo String Type Specifications and Test Methods

No.	Item	Specifications		Test Methods
		Except XM202&XV302	XM202&XV302	
1	High Temperature Storage Test	· Resistance (R25°C) fluctuation rate: less than ±1%. · B-Constant (B25/50°C) fluctuation rate: less than ±1%.	· Resistance (R25°C) fluctuation rate: less than ±3%. · B-Constant (B25/50°C) fluctuation rate: less than ±2%.	125±2°C in air, for 1000 +48/-0hrs. without loading.
2	Low Temperature Storage Test		· Resistance (R25°C) fluctuation rate: less than ±1%. · B-Constant (B25/50°C) fluctuation rate: less than ±1%.	-40 +0/-3°C in air, for 1000 +48/-0hrs. without loading.
3	Humidity Storage Test	· Resistance (R25°C) fluctuation rate: less than ±2%. · B-Constant (B25/50°C) fluctuation rate: less than ±1%.	· Resistance (R25°C) fluctuation rate: less than ±2%. · B-Constant (B25/50°C) fluctuation rate: less than ±1%.	60±2°C, 90 to 95%RH in air, for 1000 +48/-0hrs. without loading.
4	Temperature Cycle		· Resistance (R25°C) fluctuation rate: less than ±3%. · B-Constant (B25/50°C) fluctuation rate: less than ±2%.	-40 +0/-3°C, 30min. in air +25±2°C, 10 to 15min. in air +125±2°C, 30min. in air +25 +2/-0°C, 10 to 15min. in air (1 cycle) Continuous 100 cycles, without loading.
5	High Temperature Load		· Resistance (R25°C) fluctuation rate: less than ±3%. · B-Constant (B25/50°C) fluctuation rate: less than ±2%.	85±2°C in air, with 'Operating Current for Sensor' for 1000 +48/-0hrs.
6	Insulation Break - down Voltage	· No damage electrical characteristics at DC100 V, 1min.		2mm length of coating resin from the top of Thermistor is to be dipped into beads of lead (Pb), and DC100V 1min. is applied to circuit between beads of lead (Pb) and lead wire.
7	Resistance to Soldering Heat	· Resistance (R25°C) fluctuation rate: less than ±1%. · B-Constant (B25/50°C) fluctuation rate: less than ±1%.		Both lead wires are dipped into 350±10°C solder for 3.5±0.5sec., or 260±5°C solder for 10±1sec. according to Fig-1 (solder <JIS Z 3282 SnAgCu>).  Fig-1
8	Solderability	More than 90% of lead wire surface shall be covered by solder.		Both lead wires are dipped into flux (25wt% colophony <JIS K 5902> isopropyl alcohol <JIS K 8839>) for 5 to 10sec. Then both lead wires are dipped into 245±5°C solder <JIS Z 3282 SnAgCu> for 2±0.5sec. according to Fig-1.
9	Lead Wire Pull Strength	· Resistance (R25°C) fluctuation rate: less than ±1%. · B-Constant (B25/50°C) fluctuation rate: less than ±1%.		The lead wire shall be inserted in a ø1.0mm hole until resin part contacts with a substrate as shown in Fig.-2, and 1N force for 10sec. shall be applied to the lead wire.  Fig-2

* · R25 is zero-power resistance at 25°C.

· B25/50 is calculated by zero-power resistance of Thermistor in 25°C-50°C.

· After each test, NTC Thermistor should be kept for 1hr. at room temperature (normal humidity and normal atmospheric pressure).

Continued on the following page. ↗

Temperature Sensor Thermo String Type Specifications and Test Methods

Continued from the preceding page. ↘

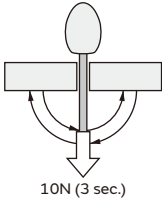
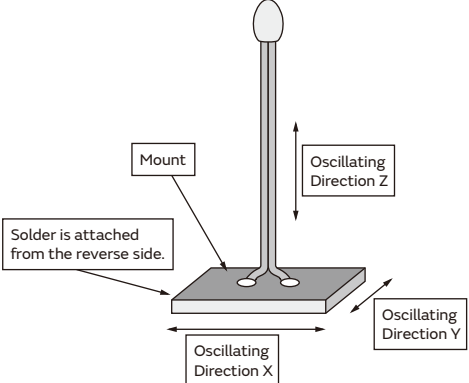
No.	Item	Specifications	Test Methods
10	Lead Wire Bending Strength	<ul style="list-style-type: none"> Lead wire does not break. 	<p>Hold the lead wires as in Fig-3. Bend by 90 degrees and again bend back to the initial position. Then bend to the other side by 90 degrees and again bend back to the initial position. After bending process, 10N force for 3sec. shall be applied to the lead wire.</p>  <p>Fig-3</p>
11	Free Fall		<p>NTC Thermistor shall be dropped without any force onto concrete floor from 1 meter height one time.</p>
12	Vibration	<ul style="list-style-type: none"> Resistance (R25°C) fluctuation rate: less than ±1%. B-Constant (B25/50°C) fluctuation rate: less than ±1%. No visible damage at resin part. 	<p>NTC Thermistor shall be fixed to the vibration test equipment. Vibration of total 1.5 mm amplitude, Frequency sequence of 10Hz - 55Hz - 10Hz in 1min. shall be applied for right angled 3 directions for 2hrs. duration each.</p> 

* · R25 is zero-power resistance at 25°C.

· B25/50 is calculated by zero-power resistance of Thermistor in 25°C-50°C.

· After each test, NTC Thermistor should be kept for 1hr. at room temperature (normal humidity and normal atmospheric pressure).

NTC Thermistors

Temperature Sensor Lead Type

This thermistor is for normal temperature level sensors having self-subsistence due to strong lead strength based on chip NTC.

Features

1. This highly accurate NTC Thermistor provides extremely precise temperature sensing.
2. This product is compatible with 1005 (1.0mm x 0.5mm) size NTC Thermistor.
3. The variation per hour of this product is highly stable.
4. This product is produced with an automation line that was consistent from lead to packaging so that a product of uniform quality may be obtained at low cost in large quantities.
5. Since this product has strong lead intensity with original lead mounting technique, it is bent at the time of use and can withstand processing, etc., readily.
Taping package can be supported.



Detailed are accessible from the following URL.
<https://www.murata.com/en-global/products/thermistor/ntc/nxr>

Applications

1. For temperature detection of a rechargeable battery pack
2. For temperature detection of a charge circuit
3. For temperature detection of a printer head
4. For temperature detection of a DC fan motor
5. For temperature detection of home electronics

Part Number	Resistance (25°C) (ohm)	B-Constant (25-50°C) (K)	B-Constant (25-80°C) (Reference Value) (K)	B-Constant (25-85°C) (Reference Value) (K)	B-Constant (25-100°C) (Reference Value) (K)	Maximum Operating Current (25°C) (mA)	Rated Electric Power (25°C) (mW)	Typical Dissipation Constant (25°C) (mW/°C)	Thermal Time Constant (25°C) (s)
NXRT15XM202EA1B□□□	2k ±3%	3500 ±1%	3539	3545	3560	0.27	7.5	1.5	4
NXRT15XV302FA1B□□□	3k ±1%	3936 ±1%	3971	3977	3989	0.22	7.5	1.5	4
NXRT15XV502FA1B□□□	5k ±1%	3936 ±1%	3971	3977	3989	0.17	7.5	1.5	4
NXRT15XH103FA1B□□□	10k ±1%	3380 ±1%	3428	3434	3455	0.12	7.5	1.5	4
NXRT15XV103FA1B□□□	10k ±1%	3936 ±1%	3971	3977	3989	0.12	7.5	1.5	4
NXRT15WB333JA1B□□□	33k ±5%	4050 ±3%	4101	4108	4131	0.07	7.5	1.5	4
NXRT15WB473FA1B□□□	47k ±1%	4050 ±1%	4101	4108	4131	0.06	7.5	1.5	4
NXRT15WF104FA1B□□□	100k ±1%	4250 ±1%	4303	4311	4334	0.04	7.5	1.5	4

□□□ is filled with Total-length codes. (10 to 50mm interval 10mm, ex. 040=40mm)

Maximum Operating Current rises Thermistor's temperature by 0.1°C.

Rated Electric Power is necessary electric power that thermistor's temperature rises 5°C by self-heating at 25°C in still air.

Taping type of part numbers with "3A016" is available (Lead Spacing=5mm).

Operating Temperature Range: -40°C to +125°C

Temperature Sensor Lead Type Specifications and Test Methods

No.	Item	Specifications	Test Methods
1	Low Temperature Storage Test	<ul style="list-style-type: none"> Resistance (R25°C) fluctuation rate: less than ±1%. B-Constant (B25/50°C) fluctuation rate: less than ±1%. 	-40 +0/-3°C in air, for 1000 +48/-0hrs. without loading.
2	High Temperature Storage Test		125±2°C in air, for 1000 +48/-0hrs. without loading.
3	High Temperature Load	<ul style="list-style-type: none"> Resistance (R25°C) fluctuation rate: less than ±2%. B-Constant (B25/50°C) fluctuation rate: less than ±1%. 	85±2°C in air, with 'Operating Current for Sensor' for 1000 +48/-0hrs.
4	Humidity Storage Test		60±2°C, 90 to 95%RH in air, for 1000 +48/-0hrs. without loading.
5	Temperature Cycle	<ul style="list-style-type: none"> Resistance (R25°C) fluctuation rate: less than ±1%. B-Constant (B25/50°C) fluctuation rate: less than ±1%. 	-40°C +0/-3°C, 30min. in air +25°C±2°C, 10 to 15min. in air +125°C +3/-0°C, 30min. in air +25°C +2/-0°C, 10 to 15min. in air (1 cycle) Continuous 100 cycles, without loading.
6	Insulation Break - down Voltage		<ul style="list-style-type: none"> No damage electrical characteristics on D.C.100 V, 1min. 2mm length of coating resin from the top of thermistor is to be dipped into beads of lead (Pb), and DC100V 1min. is applied to circuit between beads of lead (Pb) and lead wire.
7	Resistance to Soldering Heat	<ul style="list-style-type: none"> Resistance (R25°C) fluctuation rate: less than ±1%. B-Constant (B25/50°C) fluctuation rate: less than ±1%. 	Both lead wires are dipped into 350±10°C solder for 3.5±0.5sec., or 260±5°C solder for 10±1sec. according to Fig-1.  <p style="text-align: center;">Solder</p> <p style="text-align: center;">Fig-1</p>
8	Solderability	<ul style="list-style-type: none"> More than 90% of lead wire surface shall be covered by solder. 	Both lead wires are dipped into flux (25wt% colophony <JIS K 5902> isopropyl alcohol <JIS K 8839>) for 5 to 10 sec. Then both lead wires are dipped into 245±5°C solder <Sn-3Ag-0.5Cu> for 2±0.5sec. according to Fig-1.
9	Lead Wire Pull Strength	<ul style="list-style-type: none"> Resistance(R25°C) fluctuation rate: less than ±1%. B-Constant(B25/50°C) fluctuation rate: less than ±1%. No visible damage at resin part. 	One end of a lead wire shall be fixed and 2.5N force for 10sec. shall be applied to the other lead wire as shown in Fig-2.  <p style="text-align: center;">2.5N (10sec.)</p> <p style="text-align: center;">Fig-2</p>
10	Lead Wire Bending Strength	<ul style="list-style-type: none"> Lead wire does not break. 	One lead wire is held and 2.5N force is applied. Then the body of NTC thermistor is bent by 90° and again bent back to the initial position. This sequence shall be completed twice. See Fig-3.  <p style="text-align: center;">90°</p> <p style="text-align: center;">2.5N</p> <p style="text-align: center;">Fig-3</p>
11	Free Fall	<ul style="list-style-type: none"> Resistance (R25°C) fluctuation rate: less than ±1%. B-Constant (B25/50°C) fluctuation rate: less than ±1%. No visible damage at resin part. 	NTC thermistor shall be dropped without any force onto concrete floor from 1 meter height one time.
12	Vibration		NTC thermistor shall be fixed to the vibration test Equipment. Vibration of total 1.5mm amplitude, Frequency sequence of 10Hz – 55Hz – 10Hz in 1min., shall be applied for right angled 3 directions for 2hrs. duration each.

* · R25 is zero-power resistance at 25°C.
 · B25/50 is calculated by zero-power resistance of Thermistor in 25°C-50°C.
 · After each test, NTC Thermistor should be kept for 1hr. at room temperature (normal humidity and normal atmospheric pressure).

NTC Thermistors

Temperature Sensor Lead Insulation Type

This thermistor is for normal temperature level sensors having self-subsistence due to strong lead strength based on chip NTC.

Features

1. NXR series can accurately detect temperature with NCP15 series on the head of parts.
2. The insulation coat with polyurethane on the surface of lead wire : 100VDC.
3. You can choose NTC characteristics from NCP15 series.
4. The resistance drift is low in the reliability test.
5. The production capacity is bigger and NXR is produced almost entirely in an automation line.
6. Adopt to Sb regulation



Detailed are accessible from the following URL.
<https://www.murata.com/en-global/products/thermistor/ntc/nxr>

Applications

1. Secondary battery
2. Temperature detection for charging
3. Temperature detection for DC fan motor
4. Temperature sensing for appliance
5. Self-standing temperature sensing for fire detector

Part Number	Resistance (25°C) (ohm)	B-Constant (25-50°C) (K)	B-Constant (25-80°C) (Reference Value) (K)	B-Constant (25-85°C) (Reference Value) (K)	B-Constant (25-100°C) (Reference Value) (K)	Maximum Operating Current (25°C) (mA)	Rated Electric Power (25°C) (mW)	Typical Dissipation Constant (25°C) (mW/°C)	Thermal Time Constant (25°C) (s)
NXRT15XM202EA5B□□□	2k ±3%	3500 ±1%	3539	3545	3560	0.36	13	2.6	4
NXRT15XV302FA5B□□□	3k ±1%	3936 ±1%	3971	3977	3989	0.29	13	2.6	4
NXRT15XV502FA5B□□□	5k ±1%	3936 ±1%	3971	3977	3989	0.23	13	2.6	4
NXRT15XH103FA5B□□□	10k ±1%	3380 ±1%	3428	3434	3455	0.16	13	2.6	4
NXRT15XV103FA5B□□□	10k ±1%	3936 ±1%	3971	3977	3989	0.16	13	2.6	4
NXRT15WB333JA5B□□□	33k ±5%	4050 ±3%	4101	4108	4131	0.08	13	2.6	4
NXRT15WB473FA5B□□□	47k ±1%	4050 ±1%	4101	4108	4131	0.07	13	2.6	4
NXRT15WF104FA5B□□□	100k ±1%	4250 ±1%	4303	4311	4334	0.05	13	2.6	4

□□□ is filled with Total-length codes. (25 to 50mm interval 5mm, ex. 030=30mm)

Maximum Operating Current rises Thermistor's temperature by 0.1°C.

Rated Electric Power is necessary electric power that thermistor's temperature rises 5°C by self-heating at 25°C in still air.

Operating Temperature Range: -40°C to +125°C

Temperature Sensor Lead Insulation Type Specifications and Test Methods

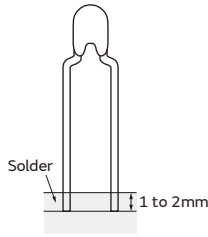
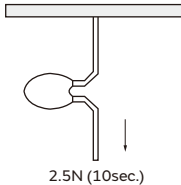
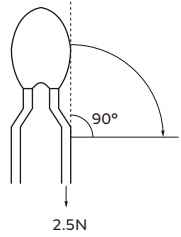
No.	Item	Specifications	Test Methods
1	Resistance to Soldering Heat (Flow)	<ul style="list-style-type: none"> Resistance (R25°C) fluctuation rate: less than ±1%. B-Constant (B25/50°C) fluctuation rate: less than ±1%. 	<p>Both lead wires are dipped into 350±10°C solder for 3.5±0.5sec., or 260 ±5°C solder for 10±1sec. according to Fig-1. (solder <SnAgCu>)</p>  <p>Fig-1</p>
2	Solderability (Flow)	<ul style="list-style-type: none"> More than 90% of lead wire surface shall be covered by solder. 	<p>Both lead wires are dipped into flux (25wt% colophony <JIS K 5902> isopropyl alcohol <JIS K 8839>) for 5 to 10sec. Then both lead wire are dipped into 245±5°C solder <SnAgCu> for 2±0.5sec. according to Fig-1.</p>
3	Lead Wire Breaking Strength	<ul style="list-style-type: none"> Resistance (R25°C) fluctuation rate: less than ±1%. B-Constant (B25/50°C) fluctuation rate: less than ±1%. 	<p>One end of a lead wire shall be fixed and 2.5N force for 10sec. shall be applied to the other lead wire as shown in Fig-2.</p>  <p>Fig-2</p>
4	Lead Wire Bending Strength	<ul style="list-style-type: none"> Lead wire does not break. 	<p>One lead wire is held and 2.5N force is applied. Then the body of NTC thermistor is bent by 90° and again bent back to the initial position. This sequence shall be completed twice. See Fig-3.</p>  <p>Fig-3</p>
5	Free Fall		<p>NTC thermistor shall be dropped without any force onto concrete floor from 1 meter height one time.</p>
6	Vibration	<ul style="list-style-type: none"> Resistance (R25°C) fluctuation rate: less than ±1%. B-Constant (B25/50°C) fluctuation rate: less than ±1%. No visible damage at resin part. 	<p>NTC thermistor shall be fixed to the vibration test equipment. Vibration of total 1.5 mm amplitude, frequency sequence of 10Hz - 55Hz - 10Hz in 1min., shall be applied for right angled 3 directions for 2hrs. duration each.</p>
7	Cold	<ul style="list-style-type: none"> Resistance (R25°C) fluctuation rate: less than ±1%. 	<p>-40 +0/-3°C in air, for 1000 +48/-0hrs. without loading.</p>
8	Dry Heat	<ul style="list-style-type: none"> B-Constant (B25/50°C) fluctuation rate: less than ±1%. 	<p>125±2°C in air, for 1000 +48/-0hrs. without loading.</p>
9	High Temperature with Continuous Load		<p>85±2°C in air, with 'Operating Current for Sensor' for 1000 +48/-0hrs.</p>
10	Damp Heat	<ul style="list-style-type: none"> Resistance (R25°C) fluctuation rate: less than ±2%. B-Constant (B25/50°C) fluctuation rate: less than ±1%. 	<p>60±2°C, 90 to 95%RH in air, for 1000 +48/-0hrs. without loading.</p>
11	Change of Temperature		<p>-40°C +0/-3°C, 30min. in air +25°C±2°C, 10 to 15min. in air +125°C +3/-0°C, 30min. in air +25°C +2/-0°C, 10 to 15min. in air (1 cycle) Continuous 100 +4/-0 cycles, without loading.</p>
12	Dielectric Breakdown Voltage	<ul style="list-style-type: none"> No damage electrical characteristics on D.C.100V, 1min. 	<p>2mm length of coating resin from the top of thermistor is to be dipped into beads of lead (Pb), and DC100V 1min. is applied to circuit between beads of lead (Pb) and lead wire.</p>

Temperature Sensor Thermo String/Lead Type Temperature Characteristics (Center Value)

Part Number	NXFT15XM202	NXFT15XV302	NXFT15XV502	NXFT15XH103	NXFT15XV103	NXFT15WB473	NXFT15WF104
Resistance	2kΩ	3kΩ	5kΩ	10kΩ	10kΩ	47kΩ	100kΩ
B-Constant	3500K	3936K	3936K	3380K	3936K	4050K	4250K
Temp. (°C)	Resistance (kΩ)	Resistance (kΩ)	Resistance (kΩ)	Resistance (kΩ)	Resistance (kΩ)	Resistance (kΩ)	Resistance (kΩ)
-40	44.981	101.251	168.752	195.652	337.503	1747.920	4397.119
-35	33.671	73.000	121.666	148.171	243.332	1245.428	3088.599
-30	25.444	53.249	88.748	113.347	177.496	898.485	2197.225
-25	19.417	39.258	65.430	87.559	130.859	655.802	1581.881
-20	14.955	29.228	48.714	68.237	97.428	483.954	1151.037
-15	11.619	21.969	36.615	53.650	73.230	360.850	846.579
-10	9.097	16.659	27.764	42.506	55.529	271.697	628.988
-5	7.178	12.740	21.233	33.892	42.467	206.463	471.632
0	5.707	9.824	16.374	27.219	32.747	158.214	357.012
5	4.568	7.635	12.725	22.021	25.450	122.259	272.500
10	3.682	5.980	9.966	17.926	19.932	95.227	209.710
15	2.986	4.718	7.864	14.674	15.727	74.730	162.651
20	2.437	3.749	6.249	12.081	12.498	59.065	127.080
25	2.000	3.000	5.000	10.000	10.000	47.000	100.000
30	1.651	2.416	4.027	8.315	8.054	37.643	79.222
35	1.370	1.959	3.264	6.948	6.529	30.334	63.167
40	1.143	1.597	2.662	5.834	5.324	24.591	50.677
45	0.958	1.310	2.183	4.917	4.366	20.048	40.904
50	0.807	1.080	1.801	4.161	3.601	16.433	33.195
55	0.682	0.896	1.493	3.535	2.985	13.539	27.091
60	0.580	0.746	1.244	3.014	2.488	11.209	22.224
65	0.495	0.625	1.041	2.586	2.083	9.328	18.323
70	0.424	0.526	0.876	2.228	1.752	7.798	15.184
75	0.365	0.444	0.740	1.925	1.480	6.544	12.635
80	0.315	0.377	0.628	1.669	1.256	5.518	10.566
85	0.273	0.321	0.535	1.452	1.070	4.674	8.873
90	0.237	0.275	0.458	1.268	0.916	3.972	7.481
95	0.207	0.236	0.394	1.110	0.787	3.388	6.337
100	0.181	0.204	0.340	0.974	0.679	2.902	5.384
105	0.160	0.177	0.294	0.858	0.588	2.494	4.594
110	0.141	0.154	0.256	0.758	0.512	2.150	3.934
115	0.124	0.134	0.223	0.672	0.446	1.860	3.380
120	0.110	0.117	0.195	0.596	0.391	1.615	2.916
125	0.098	0.103	0.172	0.531	0.343	1.406	2.522

Part Number	NXRT15XM202	NXRT15XV302	NXRT15XV502	NXRT15XH103	NXRT15XV103	NXRT15WB333	NXRT15WB473	NXRT15WF104
Resistance	2.0kΩ	3.0kΩ	5.0kΩ	10kΩ	10kΩ	33kΩ	47kΩ	100kΩ
B-Constant	3500K	3936K	3936K	3380K	3936K	4050K	4050K	4250K
Temp. (°C)	Resistance (kΩ)	Resistance (kΩ)	Resistance (kΩ)	Resistance (kΩ)	Resistance (kΩ)	Resistance (kΩ)	Resistance (kΩ)	Resistance (kΩ)
-40	44.981	101.251	168.752	195.652	337.503	1227.263	1747.920	4397.119
-35	33.671	73.000	121.666	148.171	243.332	874.449	1245.428	3088.599
-30	25.444	53.249	88.748	113.347	177.496	630.851	898.485	2197.225
-25	19.417	39.258	65.430	87.559	130.859	460.457	655.802	1581.881
-20	14.955	29.228	48.714	68.237	97.428	339.797	483.954	1151.037
-15	11.619	21.969	36.615	53.650	73.230	253.363	360.850	846.579
-10	9.097	16.659	27.764	42.506	55.529	190.766	271.697	628.988
-5	7.178	12.740	21.233	33.892	42.467	144.964	206.463	471.632
0	5.707	9.824	16.374	27.219	32.747	111.087	158.214	357.012
5	4.568	7.635	12.725	22.021	25.450	85.842	122.259	272.500
10	3.682	5.980	9.966	17.926	19.932	66.861	95.227	209.710
15	2.986	4.718	7.864	14.674	15.727	52.470	74.730	162.651
20	2.437	3.749	6.249	12.081	12.498	41.471	59.065	127.080
25	2.000	3.000	5.000	10.000	10.000	33.000	47.000	100.000
30	1.651	2.416	4.027	8.315	8.054	26.430	37.643	79.222
35	1.370	1.959	3.264	6.948	6.529	21.298	30.334	63.167
40	1.143	1.597	2.662	5.834	5.324	17.266	24.591	50.677
45	0.958	1.310	2.183	4.917	4.366	14.076	20.048	40.904
50	0.807	1.080	1.801	4.161	3.601	11.538	16.433	33.195
55	0.682	0.896	1.493	3.535	2.985	9.506	13.539	27.091
60	0.580	0.746	1.244	3.014	2.488	7.870	11.209	22.224
65	0.495	0.625	1.041	2.586	2.083	6.549	9.328	18.323
70	0.424	0.526	0.876	2.228	1.752	5.475	7.798	15.184
75	0.365	0.444	0.740	1.925	1.480	4.595	6.544	12.635
80	0.315	0.377	0.628	1.669	1.256	3.874	5.518	10.566
85	0.273	0.321	0.535	1.452	1.070	3.282	4.674	8.873
90	0.237	0.275	0.458	1.268	0.916	2.789	3.972	7.481
95	0.207	0.236	0.394	1.110	0.787	2.379	3.388	6.337
100	0.181	0.204	0.340	0.974	0.679	2.038	2.902	5.384
105	0.160	0.177	0.294	0.858	0.588	1.751	2.494	4.594
110	0.141	0.154	0.256	0.758	0.512	1.509	2.150	3.934
115	0.124	0.134	0.223	0.672	0.446	1.306	1.860	3.380
120	0.110	0.117	0.195	0.596	0.391	1.134	1.615	2.916
125	0.098	0.103	0.172	0.531	0.343	0.987	1.406	2.522

Temperature Sensor Thermo String/Lead Type ⚠Caution/Notice

⚠Caution (Storage and Operating Conditions)

This product is designed for application in an ordinary environment (normal room temperature, humidity and atmospheric pressure).

Do not use under the following conditions because all of these factors can deteriorate the product characteristics or cause failures and burn-out.

1. Corrosive gas or deoxidizing gas
(Chlorine gas, Hydrogen sulfide gas, Ammonia gas, Sulfuric acid gas, Nitric oxide gas, etc.)

2. Volatile or flammable gas
3. Dusty conditions
4. Under vacuum, or under high or low pressure
5. Wet or humid locations
6. Places with salt water, oils, chemical liquids or organic solvents
7. Strong vibrations
8. Other places where similar hazardous conditions exist

⚠Caution (Others)

Be sure to provide an appropriate fail-safe function on your product to prevent secondary damage that may be caused by the abnormal function or the failure of our product.

Notice (Storage and Operating Conditions)

To keep the solderability of the product from degrading, the following storage condition is recommended.

1. Storage condition:
Temperature -10 to +40°C
Humidity less than 75%RH (not dewing condition)
2. Storage term:
Use this product within 6 months after delivery by first-in and first-out stocking system.

3. Handling after unpacking:
After unpacking, reseal product promptly or store it in a sealed container with a drying agent.
4. Storage place:
Do not store this product in corrosive gas (Sulfuric acid gas, Chlorine gas, etc.) or in direct sunlight.

Notice (Rating)

Use this product within the specified temperature range.

Higher temperature may cause deterioration of the characteristics or the material quality of this product.

Notice (Soldering and Mounting) NXF Series

Please note as shown below when you mount this product.

1. Do not melt the solder in the resin head when you solder this product. If you do so, there is a possibility of wire breakage, electric short mode failure and wire coating breakage. If you cut the lead wire of this product less than 20mm from the resin head, the heat of the melted solder at the lead wire edge is propagated easily to the resin head along the lead wire.
2. Do not touch the resin head directly with the soldering iron. It may cause the melting of solder in the resin head.
3. Do not separate the parallel lead wires 10mm or less from the resin.
4. If you mold this product with resin, please evaluate the quality of this product before you use it.
5. Do not bend the lead wire radius 1mm or more.

Continued on the following page. ↗

Temperature Sensor Thermo String/Lead Type ⚠Caution/Notice

Continued from the preceding page. ↘

Notice (Soldering and Mounting) NXR Series

Please note as shown below when you mount this product.

1. Do not melt the solder in the resin head, when you solder this product. If you melt the solder in resin the head, the wire could break and short.

If you cut the lead wire of this product less than 8mm from the resin head, the heat of the melted solder at the lead wire edge is propagated easily to the resin head along the lead wire. Please do not cut this product below 9mm.

2. Do not touch the resin head directly with the solder iron. It may cause the melting of solder in the resin head.
3. If you mold this product with resin, please evaluate the quality of this product before you use it.

Notice (Soldering and Mounting) NXR Series (Insulation Type)

Please note as shown below when you mount this product.

1. Do not melt the solder in the resin head when you solder this product. (more than 25mm in full length of the product).

If you melt the solder in the resin head, it has possibility that the wire could break and short.

2. Do not touch the resin head directly with the solder iron. It may cause the melting of solder in the resin head.
3. When additional processing is carried out on this product (such as bonding, resin molding, and resin coating, etc.), please perform an audit of quality level on an automated machine and only use the product after confirming its reliability.

Please talk to us if you have concern matter, like process it under the high temperature and the high pressure.

(For example, exposed to high-temperature and high-pressure environment as mold sealing with injection molding.)

Notice (Handling) NXF/NXR Series

1. The ceramic element of this product is fragile, and care must be taken not to load an excessive press-force or not to cause a shock at handling. Such forces may cause cracking or chipping.
2. Do not apply excessive force to the lead. Otherwise, it may cause the junction between lead and element to break or crack. Holding the element by the side lead wire is recommended when lead wire is bent or cut.

Notice (Handling) NXR Series (Insulation Type)

1. The ceramic element of this product is fragile, and care must be taken not to load an excessive press-force or not to cause a shock at handling. Such forces may cause cracking or chipping. Especially under high-temperature environment, there is a possibility that epoxy resin will become soft. When you set up the processing environment, please examine the processing method after evaluating the quality of this product.

2. Do not apply excessive force to the lead. Otherwise, it may cause the junction between lead and element to break or crack. Holding the element by the side lead wire is recommended when lead wire is bent or cut. Handle the lead with care; there is a possibility that a crack may go into the polyurethane insulated coat when bending the lead.

Temperature Sensor Thermo String/Lead Type Package

Minimum Order Quantity

Bulk		Ammo Pack Taping	
Part Number	Minimum Quantity (pcs.)	Part Number	Minimum Quantity (pcs.)
NXF	1,000	-	-
NXR	500	NXRT_3A016	2,500

Taping Dimensions (NXRT_3A016 Series)



Item	Code	Dimensions (mm)
Pitch of Component	P	12.7±1.0
Pitch of Sprocket Hole	P0	12.7±0.3
Lead Spacing	F	5.0±1.0
Length from Hole Center to Component Center	P2	6.35±1.3
Length from Hole Center to Lead	P1	3.85±0.7
Body Diameter	D	4.0 max.
Deviation Along Tape, Left or Right	ΔS	0±2.0
Carrier Tape Width	W3	18.0±0.5
Position of Sprocket Hole	W1	9.0±0.5
Lead Distance between Reference and Bottom Planes	H0	16.0±1.0
Height of Component	H3	7.5±1.0
Protrusion Length	l	+0.5 to -1.0
Diameter of Sprocket Hole	øD0	4.0±0.1
Lead Diameter	ød	0.40±0.05
Total Tape Thickness	t1	0.6±0.3
Total Thickness, Tape and Lead Wire	t2	1.6 max.
Deviation Across Tape	Δh1, Δh2	1.0 max.
Portion to Cut in Case of Defect	L3	11.0 ⁺⁰ _{-2.0}
Hold down Tape Width	W0	9.5 min.
Hold down Tape Position	W2	1.5±1.5
Thickness	T	2.0 max.