

ON Semiconductor

Is Now

onsemi™

To learn more about onsemi™, please visit our website at
www.onsemi.com

onsemi and **onsemi** and other names, marks, and brands are registered and/or common law trademarks of Semiconductor Components Industries, LLC dba "**onsemi**" or its affiliates and/or subsidiaries in the United States and/or other countries. **onsemi** owns the rights to a number of patents, trademarks, copyrights, trade secrets, and other intellectual property. A listing of **onsemi** product/patent coverage may be accessed at www.onsemi.com/site/pdf/Patent-Marking.pdf. **onsemi** reserves the right to make changes at any time to any products or information herein, without notice. The information herein is provided "as-is" and **onsemi** makes no warranty, representation or guarantee regarding the accuracy of the information, product features, availability, functionality, or suitability of its products for any particular purpose, nor does **onsemi** assume any liability arising out of the application or use of any product or circuit, and specifically disclaims any and all liability, including without limitation special, consequential or incidental damages. Buyer is responsible for its products and applications using **onsemi** products, including compliance with all laws, regulations and safety requirements or standards, regardless of any support or applications information provided by **onsemi**. "Typical" parameters which may be provided in **onsemi** data sheets and/or specifications can and do vary in different applications and actual performance may vary over time. All operating parameters, including "Typicals" must be validated for each customer application by customer's technical experts. **onsemi** does not convey any license under any of its intellectual property rights nor the rights of others. **onsemi** products are not designed, intended, or authorized for use as a critical component in life support systems or any FDA Class 3 medical devices or medical devices with a same or similar classification in a foreign jurisdiction or any devices intended for implantation in the human body. Should Buyer purchase or use **onsemi** products for any such unintended or unauthorized application, Buyer shall indemnify and hold **onsemi** and its officers, employees, subsidiaries, affiliates, and distributors harmless against all claims, costs, damages, and expenses, and reasonable attorney fees arising out of, directly or indirectly, any claim of personal injury or death associated with such unintended or unauthorized use, even if such claim alleges that **onsemi** was negligent regarding the design or manufacture of the part. **onsemi** is an Equal Opportunity/Affirmative Action Employer. This literature is subject to all applicable copyright laws and is not for resale in any manner. Other names and brands may be claimed as the property of others.

Wide Input Voltage Low Dropout, Ultra-Low Iq Regulator

NCP716BC

The NCP716BC is 150 mA LDO Linear Voltage Regulator. It is a very stable and accurate device with ultra-low ground current consumption (4.7 μ A over the full output load range) and a wide input voltage range (up to 24 V). The regulator incorporates several protection features such as Thermal Shutdown and Current Limiting.

Features

- Operating Input Voltage Range: 2.5 V to 24 V
- Fixed Voltage Options Available: 3.0 V, 3.3 V, 3.45 V and 5.0 V
- Ultra Low Quiescent Current: Max. 4.7 μ A over Temperature
- $\pm 2\%$ Accuracy over Full Temperature Range
- Noise: 115 μ V_{RMS} from 200 Hz to 100 kHz
- Thermal Shutdown and Current Limit Protection
- Available in TSOP-5 Package
- This is a Pb-Free Device

Typical Applications

- Portable Equipment
- Communication Systems
- Industrial Measurement Systems
- Home Automation Devices

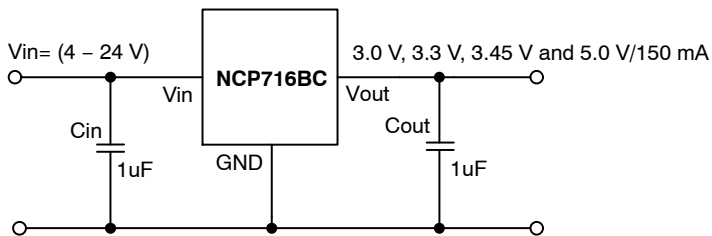
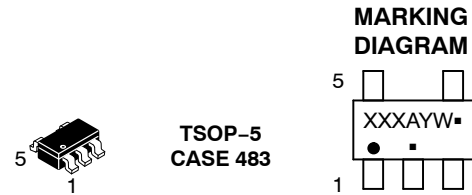

Figure 1. Typical Application Schematic



ON Semiconductor®

www.onsemi.com



XXX = Specific Device Code
 A = Assembly Location
 Y = Year
 W = Work Week
 ■ = Pb-Free Package

(Note: Microdot may be in either location)

PIN CONNECTIONS

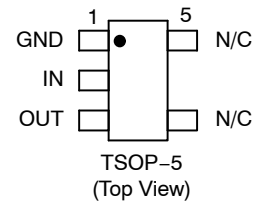

ORDERING INFORMATION

See detailed ordering, marking and shipping information in the package dimensions section on page 8 of this data sheet.

NCP716BC

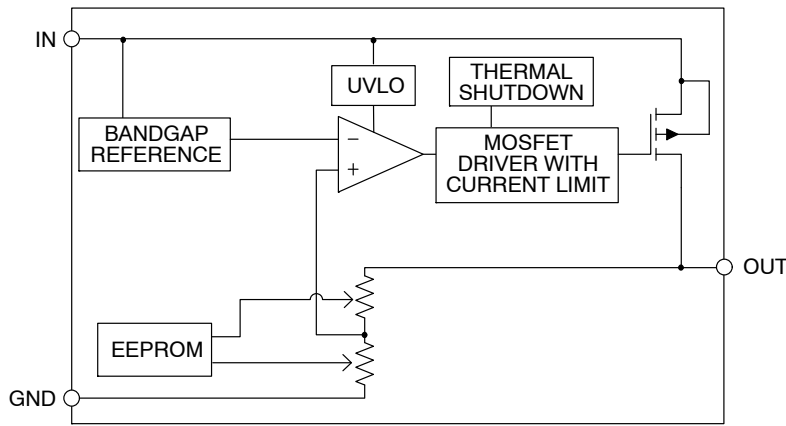

Figure 2. Simplified Block Diagram

Table 1. PIN FUNCTION DESCRIPTION

Pin No.	Pin Name	Description
3	OUT	Regulated output voltage pin. A small 1.0 μF ceramic capacitor is needed from this pin to ground to assure stability.
1	GND	Power supply ground.
2	IN	Input pin. A small 1.0 μF ceramic capacitor is needed from this pin to ground to assure stability.
4	N/C	This pin can be tied to ground to improve thermal dissipation or left disconnected.
5	N/C	This pin can be tied to ground to improve thermal dissipation or left disconnected.

Table 2. ABSOLUTE MAXIMUM RATINGS

Rating	Symbol	Value	Unit
Input Voltage (Note 1)	V_{IN}	-0.3 to 24	V
Output Voltage	V_{OUT}	-0.3 to 6	V
Output Short Circuit Duration	t_{SC}	Indefinite	s
Maximum Junction Temperature	$T_{\text{J(MAX)}}$	150	$^{\circ}\text{C}$
Storage Temperature	T_{STG}	-55 to 150	$^{\circ}\text{C}$
ESD Capability, Human Body Model (Note 2)	ESD_{HBM}	2000	V
ESD Capability, Machine Model (Note 2)	ESD_{MM}	200	V

Stresses exceeding those listed in the Maximum Ratings table may damage the device. If any of these limits are exceeded, device functionality should not be assumed, damage may occur and reliability may be affected.

1. Refer to ELECTRICAL CHARACTERISTICS and APPLICATION INFORMATION for Safe Operating Area.
2. This device series incorporates ESD protection and is tested by the following methods:
 - ESD Human Body Model tested per EIA/JESD22-A114
 - ESD Machine Model tested per EIA/JESD22-A115
 - ESD Charged Device Model tested per EIA/JESD22-C101E
 - Latchup Current Maximum Rating tested per JEDEC standard: JESD78.

Table 3. THERMAL CHARACTERISTICS

Rating	Symbol	Value	Unit
Thermal Characteristics, TSOP-5 Thermal Resistance, Junction-to-Air	$R_{\theta\text{JA}}$	250	$^{\circ}\text{C}/\text{W}$

NCP716BC

Table 4. ELECTRICAL CHARACTERISTICS Voltage version 3.0 V

$-40^{\circ}\text{C} \leq T_J \leq 125^{\circ}\text{C}$; $V_{IN} = 4.0\text{ V}$; $I_{OUT} = 1\text{ mA}$, $C_{IN} = C_{OUT} = 1.0\text{ }\mu\text{F}$, unless otherwise noted. Typical values are at $T_J = +25^{\circ}\text{C}$. (Note 5)

Parameter	Test Conditions	Symbol	Min	Typ	Max	Unit
Operating Input Voltage		V_{IN}	2.5		24	V
Output Voltage Accuracy	$-40^{\circ}\text{C} \leq T_J \leq 125^{\circ}\text{C}$	V_{OUT}	2.94	3.0	3.06	V
Line Regulation	$V_{OUT} + 1\text{ V} \leq V_{IN} \leq 24\text{ V}$, $I_{OUT} = 0.1\text{ mA}$	Reg_{LINE}		4	20	mV
Load Regulation	$I_{OUT} = 0.1\text{ mA}$ to 150 mA	Reg_{LOAD}		0.0013	0.008	%/mA
Dropout Voltage (Note 3)	$V_{OUT} = 0.97 V_{OUT(NOM)}$, $I_{OUT} = 150\text{ mA}$	V_{DO}		700	1100	mV
Maximum Output Current	(Note 6)	I_{OUT}	150			mA
Ground Current	$I_{OUT} = 0\text{ mA}$, $-40 < T_A < 125^{\circ}\text{C}$	I_{GND}		3.2	4.7	μA
Power Supply Rejection Ratio	$V_{IN} = 4.0\text{ V} + 200\text{ mVpp}$ modulation $I_{OUT} = 1\text{ mA}$, $C_{OUT} = 10\text{ }\mu\text{F}$	$f = 1\text{ kHz}$ PSRR		55		dB
Output Noise Voltage	$V_{OUT} = 3.0\text{ V}$, $I_{OUT} = 150\text{ mA}$ $f = 100\text{ Hz}$ to 100 kHz	V_{NOISE}		80		μV_{rms}
Thermal Shutdown Temperature (Note 4)	Temperature increasing from $T_J = +25^{\circ}\text{C}$	T_{SD}		180		$^{\circ}\text{C}$
Thermal Shutdown Hysteresis (Note 4)	Temperature falling from T_{SD}	T_{SDH}	-	10	-	$^{\circ}\text{C}$

3. Characterized when V_{OUT} falls 3% below the nominal $V_{OUT} = 3.0\text{ V}$

4. Guaranteed by design and characterization.

5. Performance guaranteed over the indicated operating temperature range by design and/or characterization production tested at $T_J = T_A = 25^{\circ}\text{C}$. Low duty cycle pulse techniques are used during testing to maintain the junction temperature as close to ambient as possible.

6. Please follow the Safe Operating Area.

Table 5. ELECTRICAL CHARACTERISTICS Voltage version 3.3 V

$-40^{\circ}\text{C} \leq T_J \leq 125^{\circ}\text{C}$; $V_{IN} = 4.3\text{ V}$; $I_{OUT} = 1\text{ mA}$, $C_{IN} = C_{OUT} = 1.0\text{ }\mu\text{F}$, unless otherwise noted. Typical values are at $T_J = +25^{\circ}\text{C}$. (Note 9)

Parameter	Test Conditions	Symbol	Min	Typ	Max	Unit
Operating Input Voltage		V_{IN}	2.5		24	V
Output Voltage Accuracy	$-40^{\circ}\text{C} \leq T_J \leq 125^{\circ}\text{C}$	V_{OUT}	3.234	3.30	3.366	V
Line Regulation	$V_{OUT} + 1\text{ V} \leq V_{IN} \leq 24\text{ V}$, $I_{OUT} = 0.1\text{ mA}$	Reg_{LINE}		4	20	mV
Load Regulation	$I_{OUT} = 0.1\text{ mA}$ to 150 mA	Reg_{LOAD}		0.0013	0.008	%/mA
Dropout Voltage (Note 7)	$V_{OUT} = 0.97 V_{OUT(NOM)}$, $I_{OUT} = 150\text{ mA}$	V_{DO}		685	1080	mV
Maximum Output Current	(Note 10)	I_{OUT}	150			mA
Ground Current	$I_{OUT} = 0\text{ mA}$, $-40 < T_A < 125^{\circ}\text{C}$	I_{GND}		3.2	4.7	μA
Power Supply Rejection Ratio	$V_{IN} = 4.3\text{ V} + 200\text{ mVpp}$ modulation $I_{OUT} = 1\text{ mA}$, $C_{OUT} = 10\text{ }\mu\text{F}$	$f = 1\text{ kHz}$ PSRR		54		dB
Output Noise Voltage	$V_{OUT} = 3.3\text{ V}$, $I_{OUT} = 150\text{ mA}$ $f = 100\text{ Hz}$ to 100 kHz	V_{NOISE}		86		μV_{rms}
Thermal Shutdown Temperature (Note 8)	Temperature increasing from $T_J = +25^{\circ}\text{C}$	T_{SD}		180		$^{\circ}\text{C}$
Thermal Shutdown Hysteresis (Note 8)	Temperature falling from T_{SD}	T_{SDH}	-	10	-	$^{\circ}\text{C}$

7. Characterized when V_{OUT} falls 3% below the nominal $V_{OUT} = 3.3\text{ V}$

8. Guaranteed by design and characterization.

9. Performance guaranteed over the indicated operating temperature range by design and/or characterization production tested at $T_J = T_A = 25^{\circ}\text{C}$. Low duty cycle pulse techniques are used during testing to maintain the junction temperature as close to ambient as possible.

10. Please follow the Safe Operating Area.

NCP716BC

Table 6. ELECTRICAL CHARACTERISTICS Voltage version 3.45 V

$-40^{\circ}\text{C} \leq T_J \leq 125^{\circ}\text{C}$; $V_{IN} = 4.45\text{ V}$; $I_{OUT} = 1\text{ mA}$, $C_{IN} = C_{OUT} = 1.0\text{ }\mu\text{F}$, unless otherwise noted. Typical values are at $T_J = +25^{\circ}\text{C}$. (Note 13)

Parameter	Test Conditions	Symbol	Min	Typ	Max	Unit
Operating Input Voltage		V_{IN}	2.5		24	V
Output Voltage Accuracy	$-40^{\circ}\text{C} \leq T_J \leq 125^{\circ}\text{C}$	V_{OUT}	3.381	3.45	3.519	V
Line Regulation	$V_{OUT} + 1\text{ V} \leq V_{IN} \leq 24\text{ V}$, $I_{OUT} = 0.1\text{ mA}$	Reg_{LINE}		4	20	mV
Load Regulation	$I_{OUT} = 0.1\text{ mA}$ to 150 mA	Reg_{LOAD}		0.0013	0.008	%/mA
Dropout Voltage (Note 11)	$V_{OUT} = 0.97 V_{OUT(NOM)}$, $I_{OUT} = 150\text{ mA}$	V_{DO}		680	1070	mV
Maximum Output Current	(Note 14)	I_{OUT}	150			mA
Ground Current	$I_{OUT} = 0\text{ mA}$, $-40 < T_A < 125^{\circ}\text{C}$	I_{GND}		3.2	4.7	μA
Power Supply Rejection Ratio	$V_{IN} = 4.45\text{ V} + 200\text{ mVpp}$ modulation $I_{OUT} = 1\text{ mA}$, $C_{OUT} = 10\text{ }\mu\text{F}$	$f = 1\text{ kHz}$ PSRR		54		dB
Output Noise Voltage	$V_{OUT} = 4.45\text{ V}$, $I_{OUT} = 150\text{ mA}$ $f = 100\text{ Hz}$ to 100 kHz	V_{NOISE}		88		μV_{rms}
Thermal Shutdown Temperature (Note 12)	Temperature increasing from $T_J = +25^{\circ}\text{C}$	T_{SD}		180		$^{\circ}\text{C}$
Thermal Shutdown Hysteresis (Note 12)	Temperature falling from T_{SD}	T_{SDH}	-	10	-	$^{\circ}\text{C}$

11. Characterized when V_{OUT} falls 3% below the nominal $V_{OUT} = 3.45\text{ V}$

12. Guaranteed by design and characterization.

13. Performance guaranteed over the indicated operating temperature range by design and/or characterization production tested at $T_J = T_A = 25^{\circ}\text{C}$. Low duty cycle pulse techniques are used during testing to maintain the junction temperature as close to ambient as possible.

14. Please follow the Safe Operating Area.

Table 7. ELECTRICAL CHARACTERISTICS Voltage version 5.0 V

$-40^{\circ}\text{C} \leq T_J \leq 125^{\circ}\text{C}$; $V_{IN} = 6.0\text{ V}$; $I_{OUT} = 1\text{ mA}$, $C_{IN} = C_{OUT} = 1.0\text{ }\mu\text{F}$, unless otherwise noted. Typical values are at $T_J = +25^{\circ}\text{C}$. (Note 17)

Parameter	Test Conditions	Symbol	Min	Typ	Max	Unit
Operating Input Voltage		V_{IN}	2.5		24	V
Output Voltage Accuracy	$-40^{\circ}\text{C} \leq T_J \leq 125^{\circ}\text{C}$	V_{OUT}	4.90	5.0	5.10	V
Line Regulation	$V_{OUT} + 1\text{ V} \leq V_{IN} \leq 24\text{ V}$, $I_{OUT} = 0.1\text{ mA}$	Reg_{LINE}		4	20	mV
Load Regulation	$I_{OUT} = 0.1\text{ mA}$ to 150 mA	Reg_{LOAD}		0.0013	0.008	%/mA
Dropout Voltage (Note 15)	$V_{OUT} = 0.97 V_{OUT(NOM)}$, $I_{OUT} = 150\text{ mA}$	V_{DO}		600	955	mV
Maximum Output Current	(Note 18)	I_{OUT}	150			mA
Ground Current	$I_{OUT} = 0\text{ mA}$, $-40 < T_A < 125^{\circ}\text{C}$	I_{GND}		3.2	4.7	μA
Power Supply Rejection Ratio	$V_{IN} = 6.0\text{ V} + 200\text{ mVpp}$ modulation $I_{OUT} = 1\text{ mA}$, $C_{OUT} = 10\text{ }\mu\text{F}$	$f = 1\text{ kHz}$ PSRR		53		dB
Output Noise Voltage	$V_{OUT} = 5.0\text{ V}$, $I_{OUT} = 150\text{ mA}$ $f = 100\text{ Hz}$ to 100 kHz	V_{NOISE}		115		μV_{rms}
Thermal Shutdown Temperature (Note 16)	Temperature increasing from $T_J = +25^{\circ}\text{C}$	T_{SD}		180		$^{\circ}\text{C}$
Thermal Shutdown Hysteresis (Note 16)	Temperature falling from T_{SD}	T_{SDH}	-	10	-	$^{\circ}\text{C}$

15. Characterized when V_{OUT} falls 3% below the nominal $V_{OUT} = 5.0\text{ V}$

16. Guaranteed by design and characterization.

17. Performance guaranteed over the indicated operating temperature range by design and/or characterization production tested at $T_J = T_A = 25^{\circ}\text{C}$. Low duty cycle pulse techniques are used during testing to maintain the junction temperature as close to ambient as possible.

18. Please follow the Safe Operating Area.

NCP716BC

TYPICAL CHARACTERISTICS

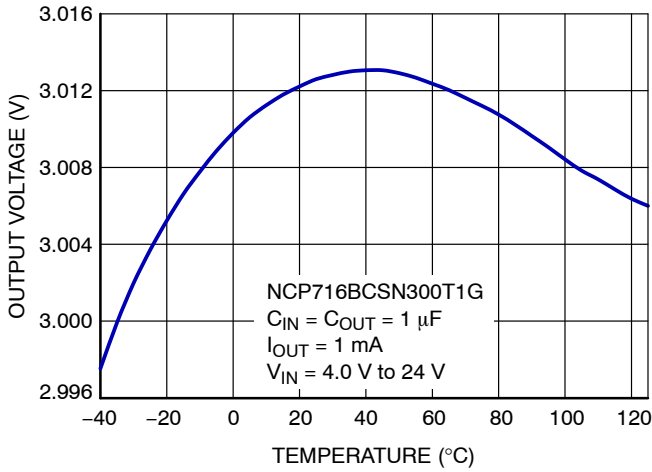

Figure 3. Output Voltage vs. Temperature

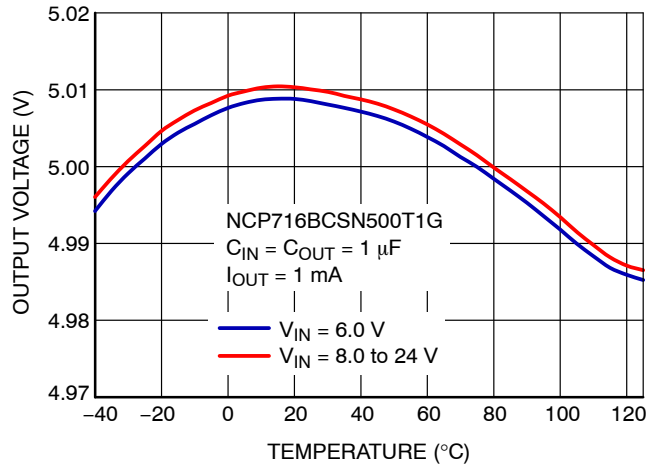

Figure 4. Output Voltage vs. Temperature

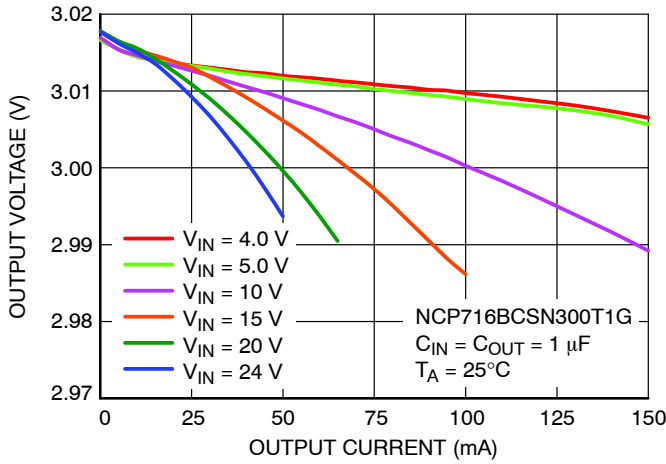

Figure 5. Output Voltage vs. Output Current

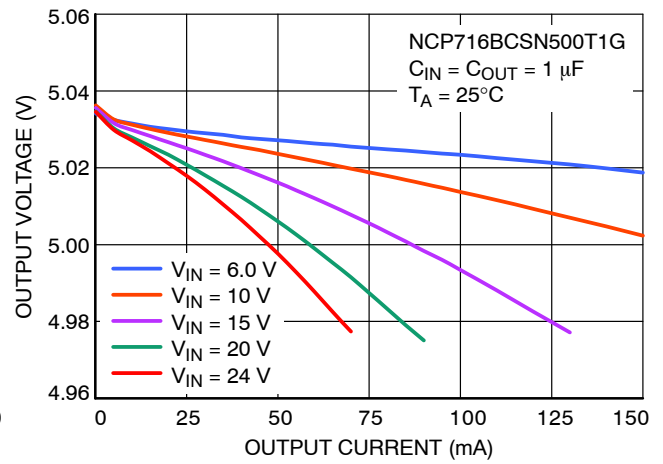

Figure 6. Output Voltage vs. Output Current

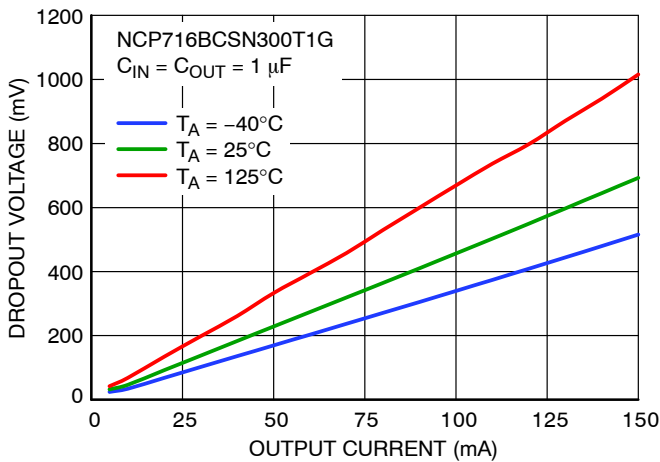

Figure 7. Dropout Voltage vs. Output Current

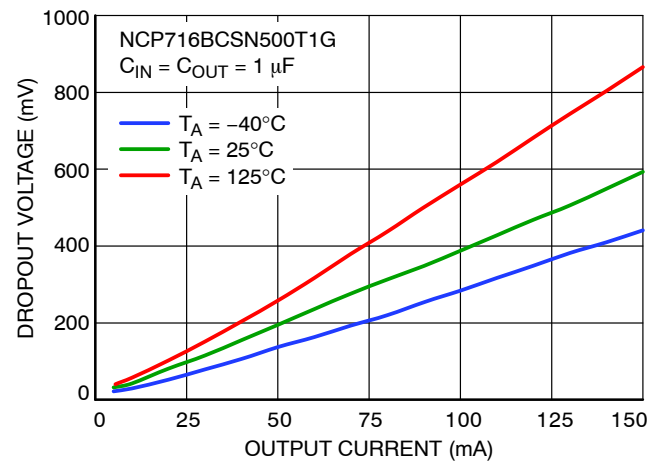

Figure 8. Dropout Voltage vs. Output Current

NCP716BC

TYPICAL CHARACTERISTICS

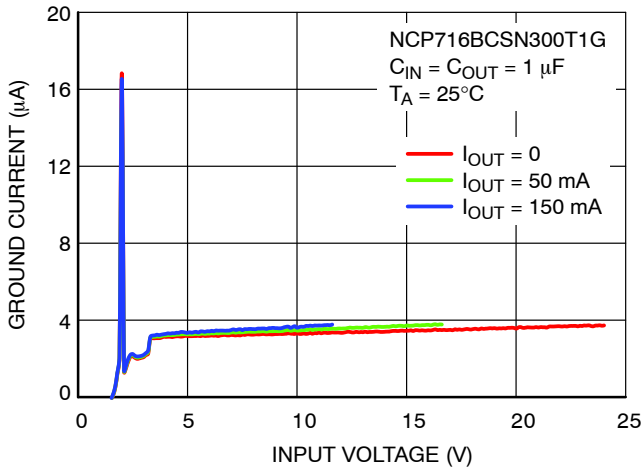

Figure 9. Ground Current vs. Input Voltage

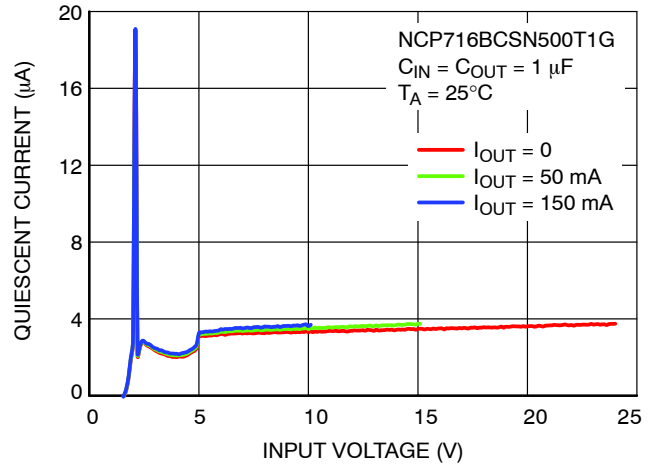

Figure 10. Ground Current vs. Input Voltage

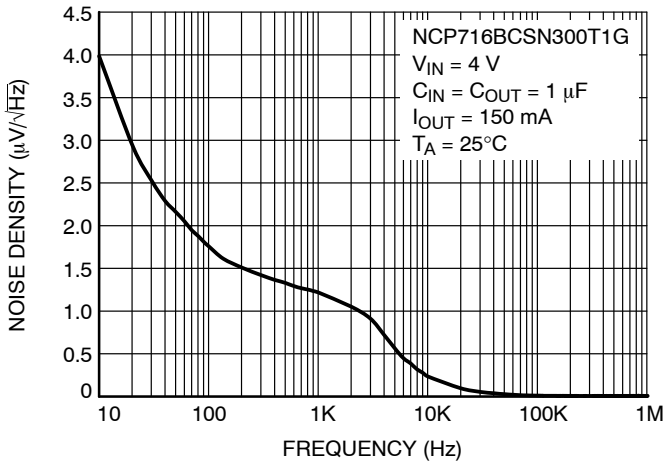

Figure 11. Spectral Noise Density vs. Frequency

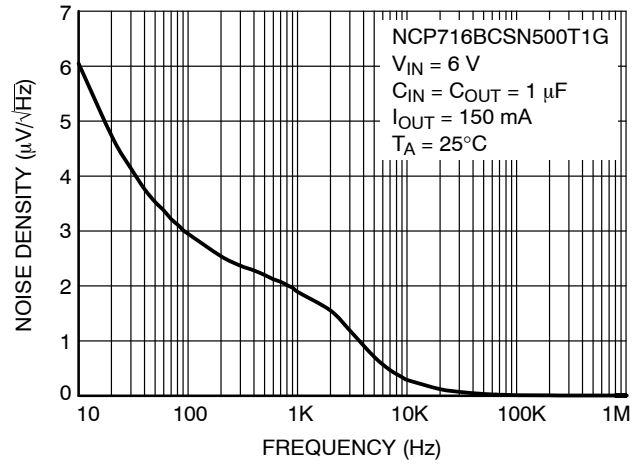

Figure 12. Spectral Noise Density vs. Frequency

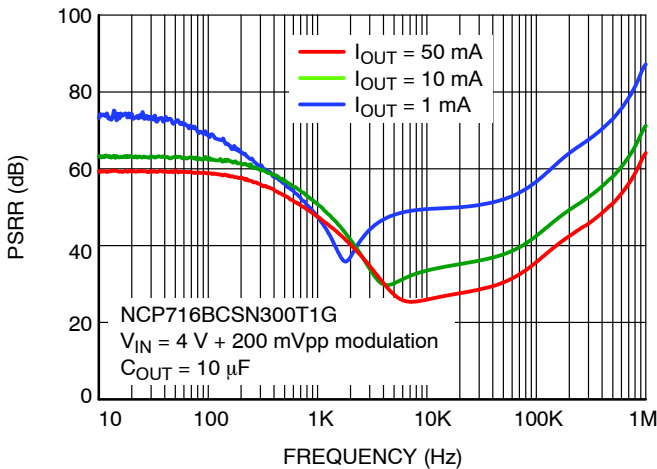

Figure 13. PSRR vs. Frequency

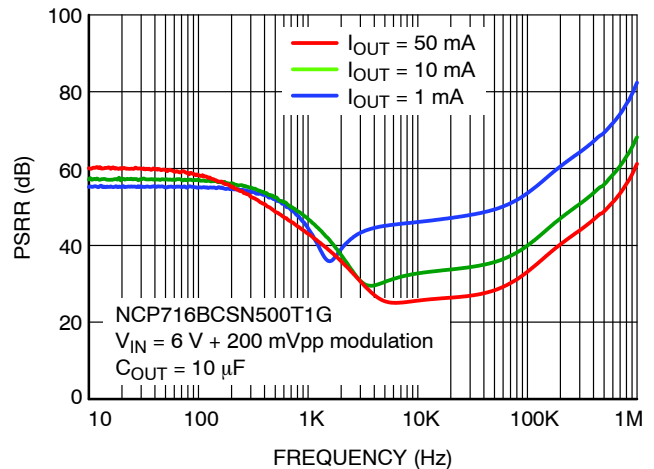

Figure 14. PSRR vs. Frequency

NCP716BC

TYPICAL CHARACTERISTICS

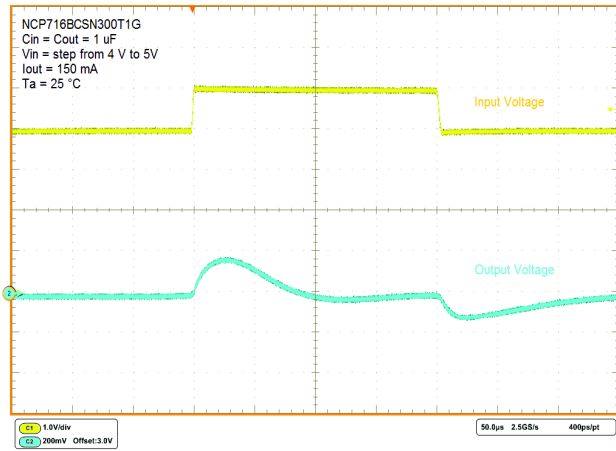

Figure 15. Line Transient Response

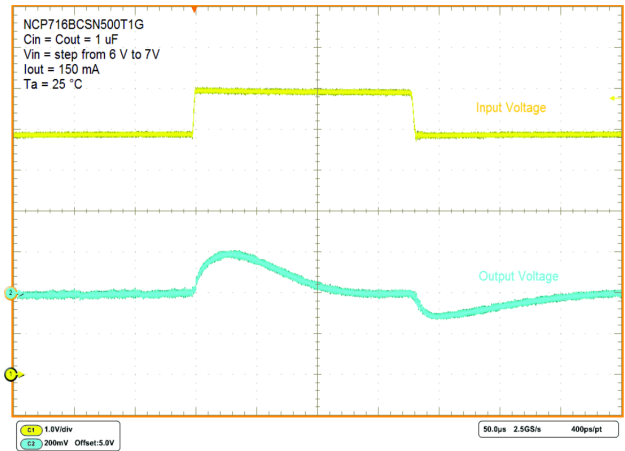

Figure 16. Line Transient Response



Figure 17. Load Transient Response

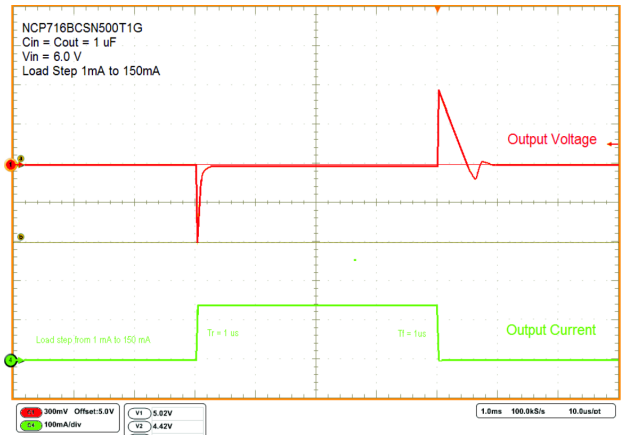

Figure 18. Load Transient Response

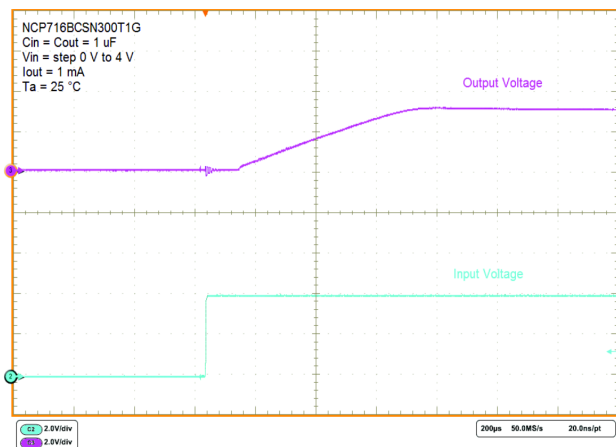

Figure 19. Turn-On Response

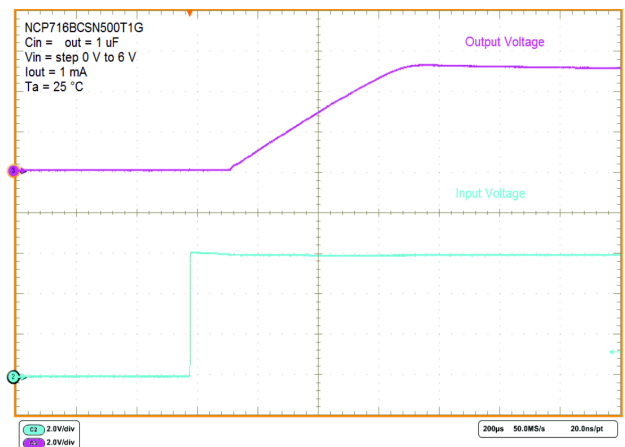

Figure 20. Turn-On Response

NCP716BC

APPLICATIONS INFORMATION

The NCP716BC is the member of new family of Wide Input Voltage Range Low Dropout Regulators which delivers Ultra Low Ground Current consumption, Good Noise and Power Supply Rejection Ratio Performance.

Input Decoupling (C_{IN})

It is recommended to connect at least 1.0 μ F Ceramic X5R or X7R capacitor between IN and GND pin of the device. This capacitor will provide a low impedance path for any unwanted AC signals or Noise superimposed onto constant Input Voltage. The good input capacitor will limit the influence of input trace inductances and source resistance during sudden load current changes.

Higher capacitance and lower ESR Capacitors will improve the overall line transient response.

Output Decoupling (C_{OUT})

The NCP716BC does not require a minimum Equivalent Series Resistance (ESR) for the output capacitor. The device is designed to be stable with standard ceramics capacitors with values of 1.0 μ F or greater up to 10 μ F. The X5R and X7R types have the lowest capacitance variations over temperature thus they are recommended.

Power Dissipation and Heat sinking

The maximum power dissipation supported by the device is dependent upon board design and layout. Mounting pad configuration on the PCB, the board material, and the ambient temperature affect the rate of junction temperature rise for the part. The maximum power dissipation the NCP716BC can handle is given by:

$$P_{D(MAX)} = \frac{[T_{J(MAX)} - T_A]}{R_{\theta JA}} \quad (\text{eq. 1})$$

The power dissipated by the NCP716BC for given application conditions can be calculated from the following equations:

$$P_D \approx V_{IN}(I_{GND}(I_{OUT})) + I_{OUT}(V_{IN} - V_{OUT}) \quad (\text{eq. 2})$$

or

$$V_{IN(MAX)} \approx \frac{P_{D(MAX)} + (V_{OUT} \times I_{OUT})}{I_{OUT} + I_{GND}} \quad (\text{eq. 3})$$

For reliable operation, junction temperature should be limited to +125°C maximum.

Hints

V_{IN} and GND printed circuit board traces should be as wide as possible. When the impedance of these traces is high, there is a chance to pick up noise or cause the regulator to malfunction. Place external components, especially the output capacitor, as close as possible to the NCP716BC, and make traces as short as possible.

ORDERING INFORMATION

Device	Voltage Option	Marking	Package	Shipping [†]
NCP716BCSN300T1G	3.0 V	7AA	TSOP-5 (Pb-Free)	3000 / Tape & Reel
NCP716BCSN330T1G	3.3 V	7AC	TSOP-5 (Pb-Free)	3000 / Tape & Reel
NCP716BCSN345T1G	3.45 V	7AM	TSOP-5 (Pb-Free)	3000 / Tape & Reel
NCP716BCSN500T1G	5.0 V	7AV	TSOP-5 (Pb-Free)	3000 / Tape & Reel

[†]For information on tape and reel specifications, including part orientation and tape sizes, please refer to our Tape and Reel Packaging Specifications Brochure, BRD8011/D.