

# ON Semiconductor

## Is Now

# onsemi™

To learn more about onsemi™, please visit our website at  
[www.onsemi.com](http://www.onsemi.com)

---

**onsemi** and **onsemi** and other names, marks, and brands are registered and/or common law trademarks of Semiconductor Components Industries, LLC dba "**onsemi**" or its affiliates and/or subsidiaries in the United States and/or other countries. **onsemi** owns the rights to a number of patents, trademarks, copyrights, trade secrets, and other intellectual property. A listing of **onsemi** product/patent coverage may be accessed at [www.onsemi.com/site/pdf/Patent-Marking.pdf](http://www.onsemi.com/site/pdf/Patent-Marking.pdf). **onsemi** reserves the right to make changes at any time to any products or information herein, without notice. The information herein is provided "as-is" and **onsemi** makes no warranty, representation or guarantee regarding the accuracy of the information, product features, availability, functionality, or suitability of its products for any particular purpose, nor does **onsemi** assume any liability arising out of the application or use of any product or circuit, and specifically disclaims any and all liability, including without limitation special, consequential or incidental damages. Buyer is responsible for its products and applications using **onsemi** products, including compliance with all laws, regulations and safety requirements or standards, regardless of any support or applications information provided by **onsemi**. "Typical" parameters which may be provided in **onsemi** data sheets and/or specifications can and do vary in different applications and actual performance may vary over time. All operating parameters, including "Typicals" must be validated for each customer application by customer's technical experts. **onsemi** does not convey any license under any of its intellectual property rights nor the rights of others. **onsemi** products are not designed, intended, or authorized for use as a critical component in life support systems or any FDA Class 3 medical devices or medical devices with a same or similar classification in a foreign jurisdiction or any devices intended for implantation in the human body. Should Buyer purchase or use **onsemi** products for any such unintended or unauthorized application, Buyer shall indemnify and hold **onsemi** and its officers, employees, subsidiaries, affiliates, and distributors harmless against all claims, costs, damages, and expenses, and reasonable attorney fees arising out of, directly or indirectly, any claim of personal injury or death associated with such unintended or unauthorized use, even if such claim alleges that **onsemi** was negligent regarding the design or manufacture of the part. **onsemi** is an Equal Opportunity/Affirmative Action Employer. This literature is subject to all applicable copyright laws and is not for resale in any manner. Other names and brands may be claimed as the property of others.

# NCV8518C

## Linear Regulator - Low Dropout, Watchdog, Wake Up, RESET, ENABLE

The NCV8518C device is a precision micropower voltage regulator. It has a fixed output voltage of 5.0 V and regulates within  $\pm 2\%$ . It is suitable for use in all automotive environments and contains all the required functions to control a microprocessor. This device has low dropout voltage and low quiescent current. It includes a watchdog timer, adjustable reset, wake up and enable function. Also encompassed in this device are safety features such as thermal shutdown and short circuit protection. It is capable of handling up to 45 V transients.

### Features

- Output Voltage Option: 5.0 V
- Output Voltage Accuracy:  $\pm 2\%$
- Output Current up to 250 mA
- Low Dropout Voltage
- Low Quiescent Current of 70  $\mu\text{A}$
- Low Sleep Mode Current less than 1.0  $\mu\text{A}$
- Micropower Compatible Control Functions:
  - ENABLE
  - Watchdog
  - RESET
  - Wake Up
- Protection Features:
  - Thermal Shutdown
  - Current Limitation
- NCV Prefix for Automotive and Other Applications Requiring Site and Change Control
- AEC-Q100 Grade 1 Qualified and PPAP Capable
- These Devices are Pb-Free and are RoHS Compliant

### Applications (for safety applications refer to Figure 22)

- Body and Chassis
- Instrument and Clusters
- Engine Control Unit



ON Semiconductor®

[www.onsemi.com](http://www.onsemi.com)

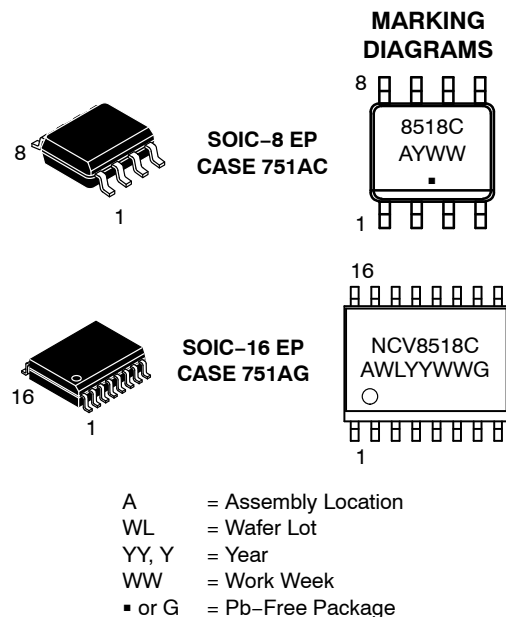

### ORDERING INFORMATION

Device	Package	Shipping†
NCV8518CPDR2G	SOIC-8 (Pb-Free)	2500 / Tape & Reel
NCV8518CPWR2G (In Development)	SOIC-16 (Pb-Free)	1000 / Tape & Reel

†For information on tape and reel specifications, including part orientation and tape sizes, please refer to our Tape and Reel Packaging Specifications Brochure, BRD8011/D.

# NCV8518C

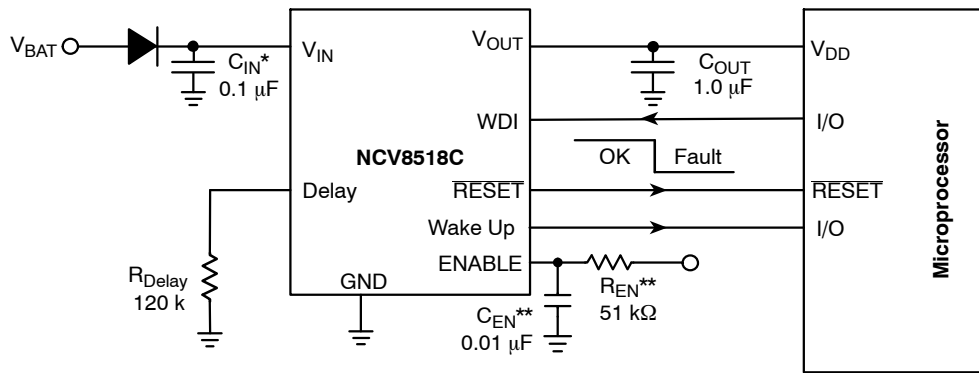

\* $C_{IN}$  required if regulator is located far from power supply filter. If extremely fast input voltage transients are expected then appropriate input filter must be used. The filter can be composed of several capacitors in parallel.

\*\*The RC filter is only required when transients with slew rate in excess of  $1 \text{ V}/\mu\text{s}$  may be present on the ENABLE voltage source during operation. The filter is not required when ENABLE is connected to a noise-free DC voltage.

**Figure 1. Application Circuit**

## PIN CONNECTIONS

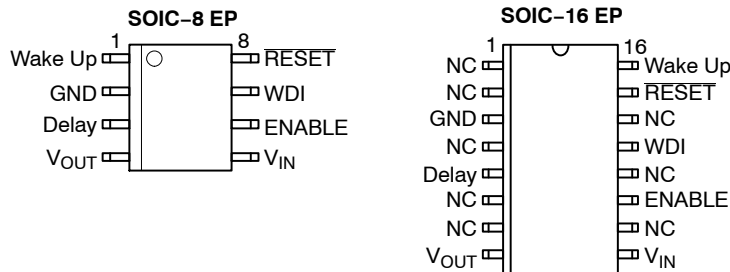

## PIN FUNCTION DESCRIPTION

Pin No.		Pin Name	Description
SOIC-8 EP	SOIC-16 EP		
4	8	$V_{OUT}$	Regulated Output Voltage.
5	9	$V_{IN}$	Positive Power Supply. Connect capacitor to ground.
7	13	WDI	CMOS compatible Watchdog Input. The watchdog function monitors the falling edge of the incoming signal.
2	3	GND	Power Supply Ground.
6	11	ENABLE	ENABLE Input. Low level disables the chip. Connect to $V_{IN}$ if this function is not needed.
8	15	$\overline{\text{RESET}}$	CMOS compatible output $\overline{\text{RESET}}$ goes low whenever $V_{OUT}$ drops by more than 7.0% from nominal, or during the absence of a correct watchdog signal.
3	5	Delay	Delay Timing. Buffered reference voltage used to create timing current for $\overline{\text{RESET}}$ and Watchdog threshold frequency from $R_{Delay}$ .
-	1, 2, 4, 6, 7, 10, 12, 14	NC	Not Connected. Not internally bonded.
1	16	Wake Up	Continuously generated signal that interrupts the microprocessor from sleep mode.
EPAD	EPAD	Exposed Pad	Connect to Ground potential or leave unconnected.

# NCV8518C

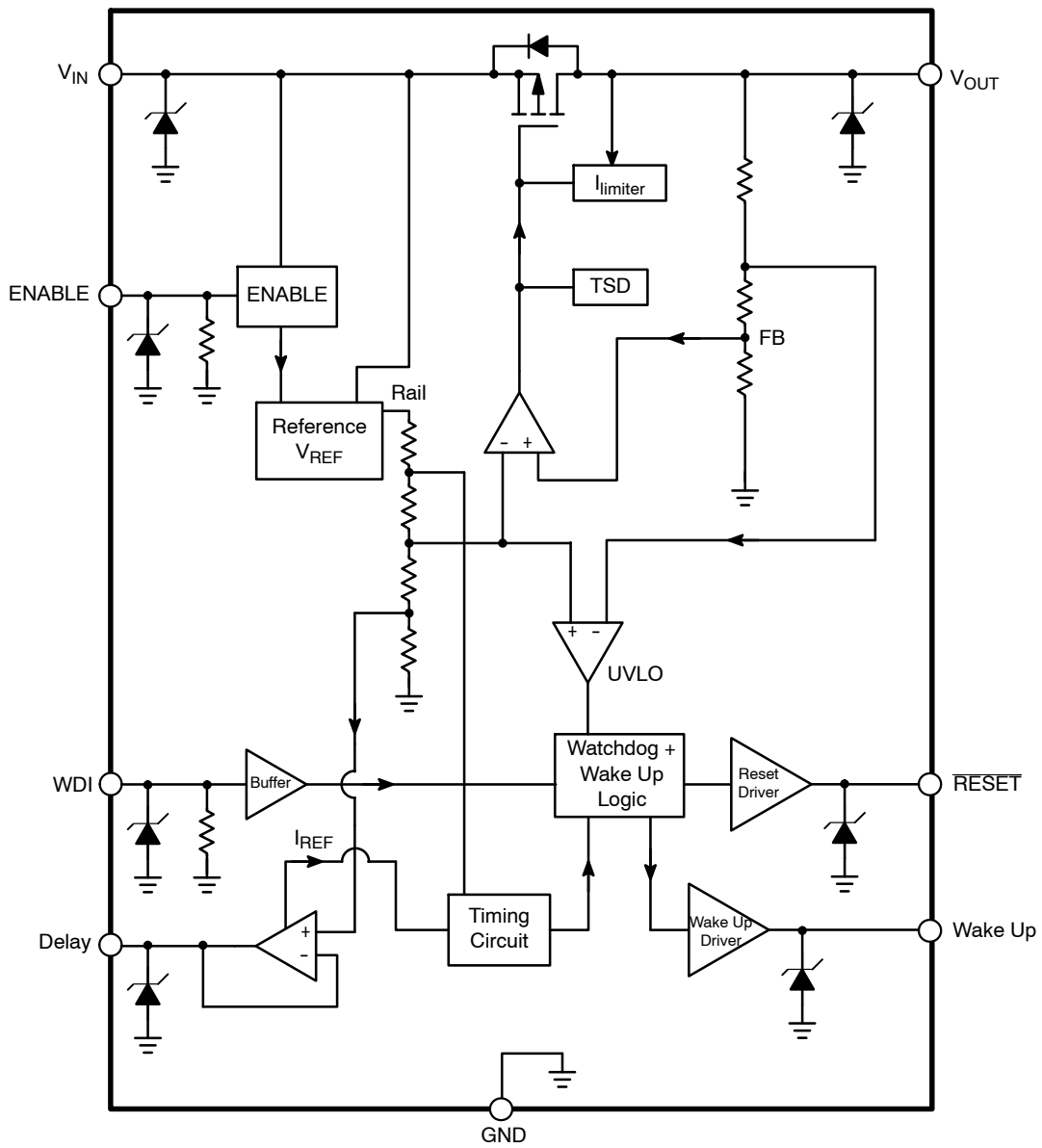

Figure 1. Block Diagram

# NCV8518C

## MAXIMUM RATINGS

Rating	Symbol	Min	Max	Unit
DC Voltage (Note 1) Input Voltage ENABLE Voltage	$V_{IN}$ $V_{ENABLE}$	-0.3	40	V
Peak Transient Voltage (Load Dump) (Note 2) Input Voltage ENABLE Voltage	$V_{IN}$ $V_{ENABLE}$		45	V
Output Voltage	$V_{OUT}$	-0.3	+7.0	V
RESET Output Voltage Powered chip or connected external components to chip Pin to Ground only, all other pins left disconnected	$V_{RESET}$	-0.3 -0.3	$V_{OUT}$ +7.0	V
RESET Output Current (RESET may be incidentally shorted either to $V_{OUT}$ or to GND without damage)	$I_{RESET}$	-	Internally Limited	mA
Wake Up Voltage Powered chip or connected external components to chip Pin to Ground only, all other pins left disconnected	$V_{Wake\_Up}$	-0.3 -0.3	$V_{OUT}$ +7.0	V
Watchdog Input Voltage	$V_{WDI}$	-0.3	+7.0	V
Delay Timing Voltage	$V_{Delay}$	-0.3	+3.6	V
Operating Junction Temperature	$T_J$	-40	+150	°C
Storage Temperature Range	$T_S$	-55	+150	°C

Stresses exceeding those listed in the Maximum Ratings table may damage the device. If any of these limits are exceeded, device functionality should not be assumed, damage may occur and reliability may be affected.

1. Refer to ELECTRICAL CHARACTERISTICS and APPLICATION INFORMATION for Safe Operating Area.
2. Load Dump Test B (with centralized load dump suppression) according to ISO16750-2 standard. Guaranteed by design. Not tested in production. Passed Class B according to ISO16750-1.

## ESD CAPABILITY (Note 3)

Rating	Symbol	Min	Max	Unit
ESD Capability, Human Body Model	$ESD_{HBM}$	-2	2	kV
ESD Capability, Charged Device Model	$ESD_{CDM}$	-1	1	kV

3. This device series incorporates ESD protection and is tested by the following methods:  
ESD Human Body Model tested per AEC-Q100-002 (JS-001-2010).  
Field Induced Charge Device Model ESD characterization is not performed on plastic molded packages with body sizes <50 mm<sup>2</sup> due to the inability of a small package body to acquire and retain enough charge to meet the minimum CDM discharge current waveform characteristic defined in JEDEC JS-002-2014.

## LEAD SOLDERING TEMPERATURE AND MSL (Note 4)

Rating	Symbol	Min	Max	Unit
Moisture Sensitivity Level SOIC-16 EP (Case 751AG) SOIC-8 EP (Case 751AC)	MSL		1 2	-
Lead Temperature Soldering: Reflow Leaded Part 60-150 sec above 183 °C, 30 sec max at peak Lead-Free Part 60-150 sec above 217 °C, 40 sec max at peak	$T_{SLD}$	- -	240 peak 265 peak	°C °C

4. For more information, please refer to our Soldering and Mounting Techniques Reference Manual, SOLDERRM/D.

# NCV8518C

## THERMAL CHARACTERISTICS (Note 6)

Parameter	Board/Mounting Conditions Typical Value		Unit
-----------	---	--	------

### SOIC-8 EP Package

	100 sq. mm spreader board	1 sq. inch spreader board	
Junction to case top ( $\Psi_{JT}$ )	35.3	26.2	°C/W
Junction to lead1 ( $\Psi_{JL1}$ )	66.3	44.8	°C/W
Junction to board ( $\Psi_{JB}$ ) (Notes 5)	27.9	24.6	°C/W
Junction to ambient ( $\theta_{JA}$ )	133.4	83.7	°C/W

### SOIC-16 EP Package

	100 sq. mm spreader board	1 sq. inch spreader board	
Junction to case top ( $\Psi_{JT}$ )	55.7	29.9	°C/W
Junction to lead1 ( $\Psi_{JL1}$ )	95.9	39.9	°C/W
Junction to board ( $\Psi_{JB}$ ) (Notes 5)	29	24.1	°C/W
Junction to ambient ( $\theta_{JA}$ )	152	71.5	°C/W

All boards are 0.062" thick FR4, 3" square, with varying amounts of copper heat spreader, in still air (free convection) conditions.

Numerical values are derived from an axisymmetric finite-element model where active die area, total die area, flag area, pad area, and board area are equated to the actual corresponding areas.

5. "board" is defined as center of exposed pad soldered to board; this is the recommended number to be used for thermal calculations, as it best represents the primary heat flow path and is least sensitive to board and ambient properties.
6. Values based on copper area of 645 mm<sup>2</sup> (or 1 in<sup>2</sup>) of 1 oz copper thickness and FR4 PCB substrate. Single layer – according to JEDEC51.3, 4 layers – according to JEDEC51.7.

# NCV8518C

**ELECTRICAL CHARACTERISTICS** ( $6.0\text{ V} \leq V_{IN} \leq 28\text{ V}$ ,  $V_{ENABLE} = 5\text{ V}$ ,  $100\text{ }\mu\text{A} \leq I_{OUT} \leq 150\text{ mA}$ ,  $C_{IN} = 100\text{ nF}$ ,  $C_{OUT} = 1.0\text{ }\mu\text{F}$  ceramic,  $R_{Delay} = 60\text{ k}\Omega$ . Min and Max values are valid for temperature range  $-40^\circ\text{C} \leq T_J \leq 150^\circ\text{C}$  unless otherwise noted and are guaranteed by test design or statistical correlation. Typical values are referenced to  $T_J = 25^\circ\text{C}$ .) (Notes 8 and 9)

Characteristic	Symbol	Min	Typ	Max	Unit
----------------	--------	-----	-----	-----	------

## Output

Output Voltage	$V_{OUT}$	4.9 -2%	5.00	5.10 +2%	V
Dropout Voltage ( $V_{IN} - V_{OUT}$ , $I_{OUT} = 150\text{ mA}$ ) (Note 7)	$V_{DO}$	-	356	750	mV
Load Regulation ( $V_{IN} = 13.5\text{ V}$ , $I_{OUT} = 100\text{ }\mu\text{A}$ to $150\text{ mA}$ )	$Reg_{load}$	-30	-	30	mV
Line Regulation ( $I_{OUT} = 5.0\text{ mA}$ , $V_{IN} = 6.0\text{ V}$ to $28\text{ V}$ )	$Reg_{line}$	-20	-	20	mV
Current Limit ( $V_{OUT} = 0.95 \times V_{OUT\_nom}$ , $V_{in} = 13.5\text{ V}$ )	$I_{LIM}$	255	510	-	mA
Thermal Shutdown (Guaranteed by Design)	$T_{Jmax}$	150	175	210	$^\circ\text{C}$
Quiescent Current ( $V_{IN} = 13.5\text{ V}$ , $I_{OUT} = 100\text{ }\mu\text{A}$ , $ENABLE = 2.0\text{ V}$ )	$I_q$	-	70	85	$\mu\text{A}$
Disable Current ( $ENABLE = 0\text{ V}$ , $T_A \leq +125^\circ\text{C}$ )	$I_{DIS}$	-	-	1.0	$\mu\text{A}$

## RESET

Threshold Voltage 	-	4.5	4.65	4.75	V
Output Low ( $R_{RESET} = 10\text{ k}\Omega$ to $V_{OUT}$ , $V_{OUT} = 1.0\text{ V}$ )	-	-	0.025	0.4	V
Output High ( $R_{RESET} = 10\text{ k}\Omega$ to GND)	-	4.5	4.86	-	V
Power On Reset Delay Time ( $V_{IN} = 13.5\text{ V}$ , $R_{Delay} = 60\text{ k}\Omega$ , $I_{OUT} = 5.0\text{ mA}$ ) ( $V_{IN} = 13.5\text{ V}$ , $R_{Delay} = 120\text{ k}\Omega$ , $I_{OUT} = 5.0\text{ mA}$ ) ( $V_{IN} = 13.5\text{ V}$ , $R_{Delay} = 500\text{ k}\Omega$ , $I_{OUT} = 5.0\text{ mA}$ )	POR	2.0 - -	3.1 6.2 26	4.0 - -	ms
Reset Reaction Time	$t_{RR}$	-	20	-	$\mu\text{s}$

## Watchdog Input

Threshold Voltage	$WDI_{high}$	30	50	70	% of $V_{OUT}$
Hysteresis (Guaranteed by design) 	$WDI_{hys}$	25	100	-	mV
Input Current ( $WDI = 6.0\text{ V}$ )	-	-	1.1	2.0	$\mu\text{A}$

## ENABLE

Threshold Voltage Logic Low ( $V_{OUT} \leq 0.1\text{ V}$ ) Logic High ( $V_{OUT} \geq 4.5\text{ V}$ )	$V_{th(ENABLE)}$	- 2.0	- -	0.8 -	V
Input Current ( $ENABLE = 2.0\text{ V}$ )	$I_{ENABLE}$	-	2.4	10	$\mu\text{A}$

7. Measured when the output voltage has dropped 100 mV from the nominal value obtained at nominal input voltage.
8. Refer to ABSOLUTE MAXIMUM RATINGS and OPERATION DESCRIPTION for Safe Operating Area.
9. Performance guaranteed over the indicated operating temperature range by design and/or characterization tested at  $T_A = T_J$ . Low duty cycle pulse techniques are used during testing to maintain the junction temperature as close to ambient as possible.

# NCV8518C

**ELECTRICAL CHARACTERISTICS (continued)** ( $6.0\text{ V} \leq V_{IN} \leq 28\text{ V}$ ,  $V_{ENABLE} = 5\text{ V}$ ,  $100\ \mu\text{A} \leq I_{OUT} \leq 150\text{ mA}$ ,  $C_{IN} = 100\text{ nF}$ ,  $C_{OUT} = 1.0\ \mu\text{F}$  ceramic,  $R_{Delay} = 60\text{ k}\Omega$ . Min and Max values are valid for temperature range  $-40^\circ\text{C} \leq T_J \leq 150^\circ\text{C}$  unless otherwise noted and are guaranteed by test design or statistical correlation. Typical values are referenced to  $T_J = 25^\circ\text{C}$ .)

Characteristic	Symbol	Min	Typ	Max	Unit
<b>Wake Up Output</b> ( $V_{IN} = 13.5\text{ V}$ , $I_{OUT} = 5.0\text{ mA}$ )					
Wake Up Period ( $R_{Delay} = 60\text{ k}\Omega$ ) ( $R_{Delay} = 120\text{ k}\Omega$ ) ( $R_{Delay} = 500\text{ k}\Omega$ )	–	18 – –	24 47 194	32 – –	ms
Wake Up Duty Cycle Nominal	–	45	50	55	%
RESET HIGH to Wake Up Rising Delay Time ( $R_{Delay} = 60\text{ k}\Omega$ ) ( $R_{Delay} = 120\text{ k}\Omega$ ) ( $R_{Delay} = 500\text{ k}\Omega$ ) 50% RESET Rising Edge to 50% Wake Up Edge	–	9.0 – –	12 23.5 97	16 – –	ms
Wake Up Response to Watchdog Input 50% WDI Falling Edge to 50% Wake Up Falling Edge	–	–	0.65	2.0	$\mu\text{s}$
Wake Up Response to RESET 50% RESET Falling Edge to 50% Wake Up Falling Edge ( $V_{OUT} = 5.0\text{ V} \rightarrow 4.5\text{ V}$ )	–	–	0.012	1.0	$\mu\text{s}$
Output Low ( $R_{WakeUp} = 10\text{ k}\Omega$ to $V_{OUT}$ )	–	–	0.085	0.4	V
Output High ( $R_{WakeUp} = 10\text{ k}\Omega$ to GND)	–	4.5	4.86	–	V
<b>Delay</b>					
Output Voltage ( $R_{Delay} = 60\text{ k}\Omega, 120\text{ k}\Omega, 500\text{ k}\Omega$ )	–	–	0.48	–	V

## DEFINITION OF TERMS

**Dropout Voltage:** The input-to-output voltage differential at which the circuit ceases to regulate against further reduction in input voltage. Measured when the output voltage has dropped 100 mV from the nominal value obtained at nominal input voltage, dropout voltage is dependent upon load current and junction temperature.

**Input Voltage:** The DC voltage applied to the input terminals with respect to ground.

**Line Regulation:** The change in output voltage for a change in the input voltage. The measurement is made under conditions of low dissipation or by using pulse techniques such that the average chip temperature is not significantly affected.

**Load Regulation:** The change in output voltage for a change in load current at constant chip temperature.

**Quiescent Current:** The part of the positive input current that does not contribute to the positive load current. The regulator ground lead current with no load.

**Current Limit:** Peak current that can be delivered to the output.



TIMING DIAGRAMS

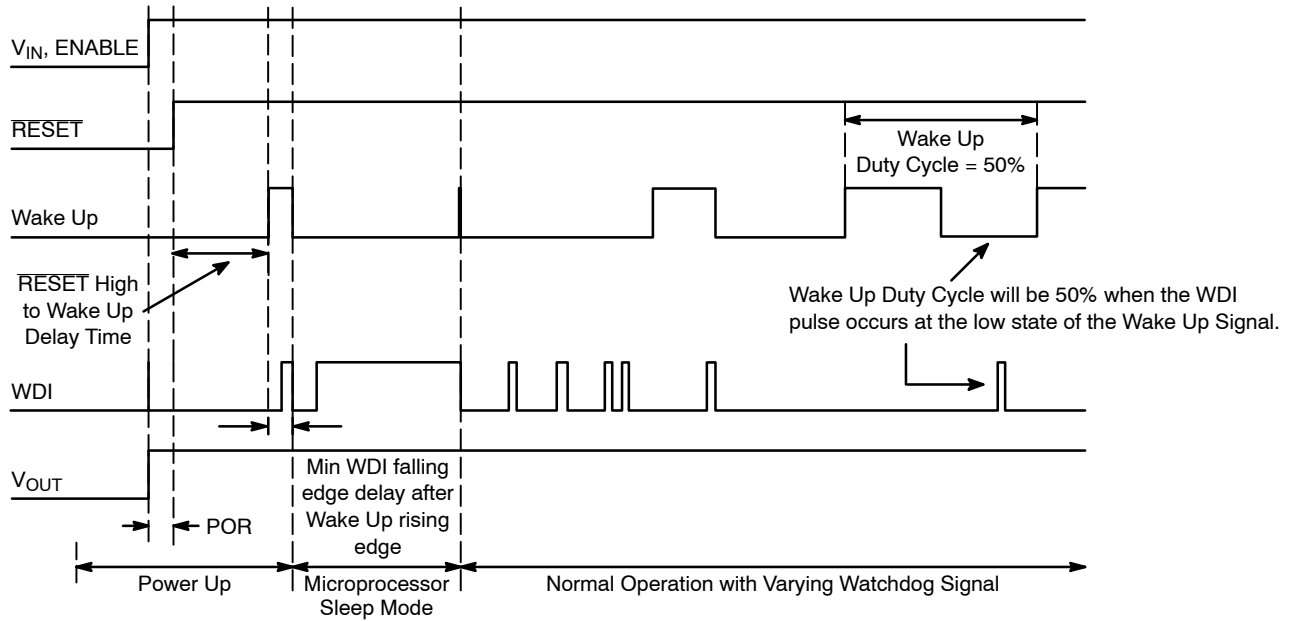

Figure 2. Power Up, Sleep Mode and Normal Operation

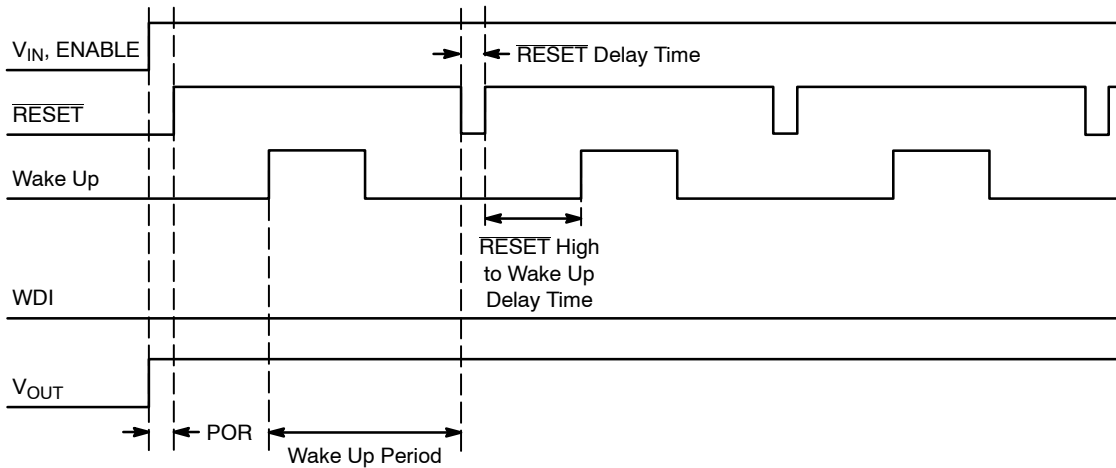

Figure 3. Error Condition: Watchdog Remains Low and a RESET is Issued

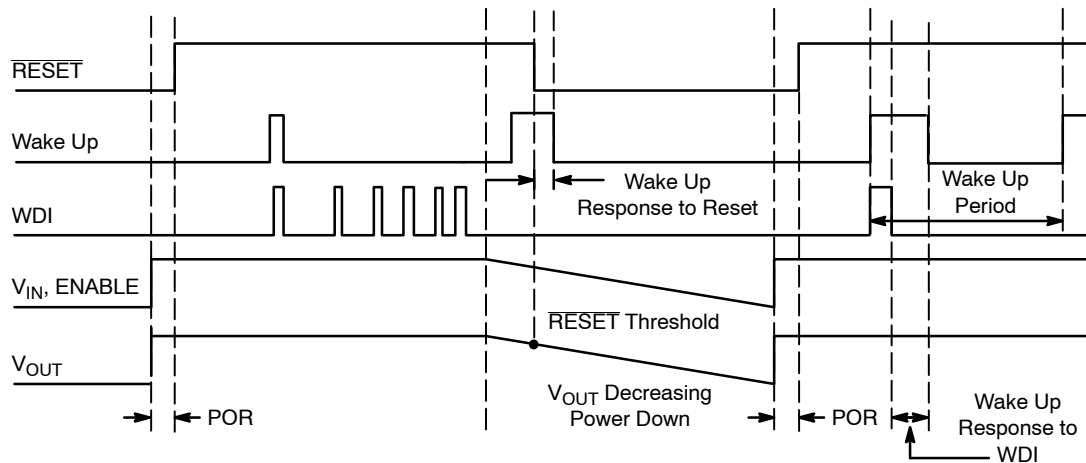

Figure 4. Power Down, Restart Sequence, and Wake Up Response to WDI

TYPICAL CHARACTERISTICS

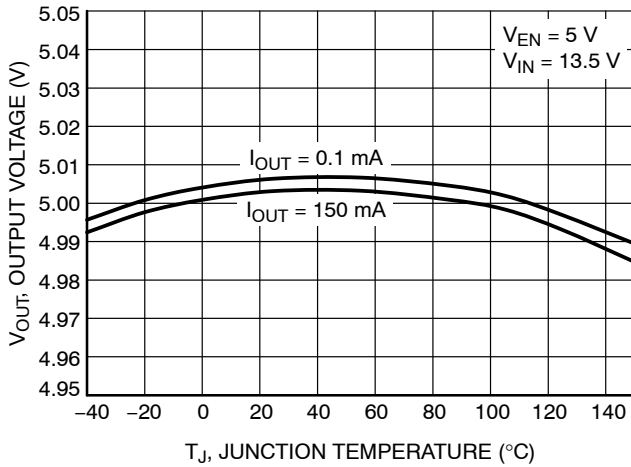

Figure 5. Output Voltage vs. Temperature

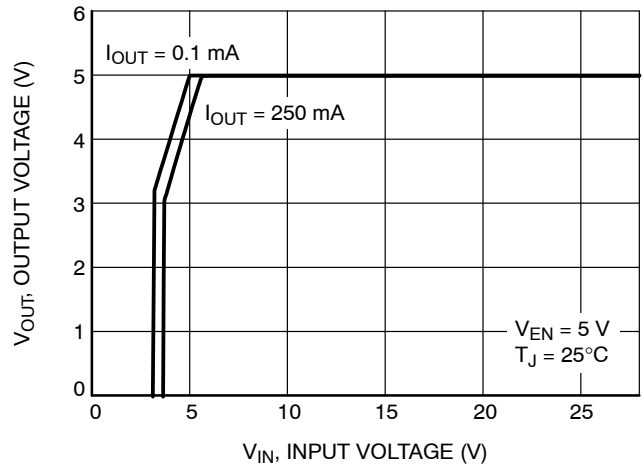

Figure 6. Output Voltage vs. Input Voltage

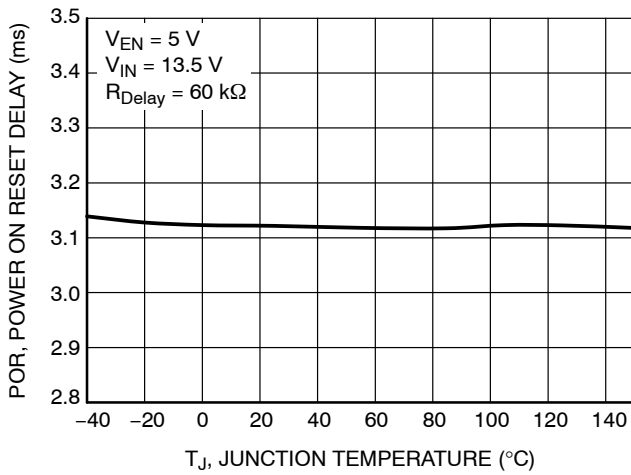

Figure 7. POR, Power On Reset Delay Time vs. Temperature,  $R_{Delay} = 60\text{ k}\Omega$

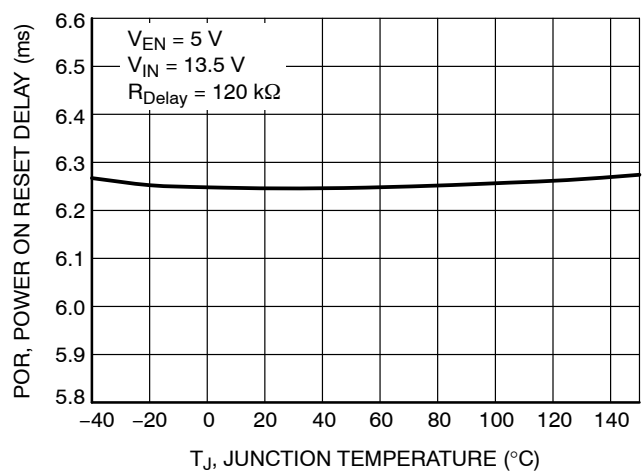

Figure 8. POR, Power On Reset Delay Time vs. Temperature,  $R_{Delay} = 120\text{ k}\Omega$

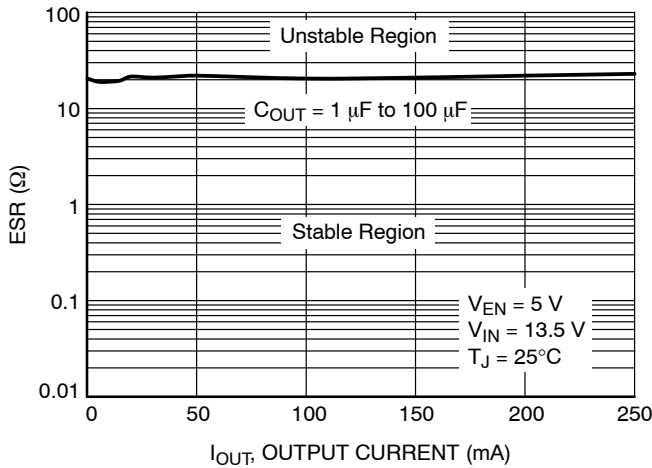

Figure 9. Stability Region of Capacitive ESR vs. Output Current

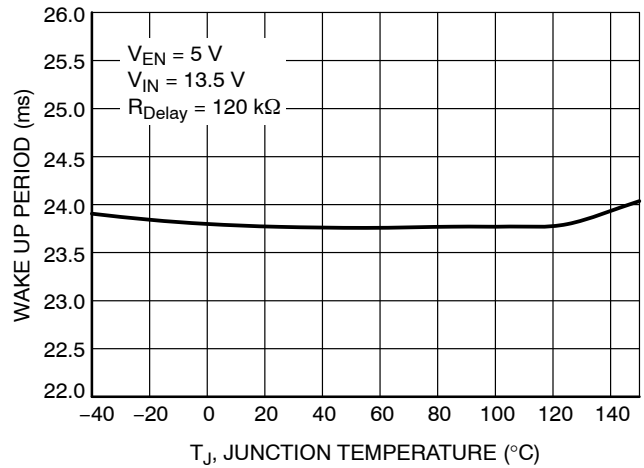

Figure 10. Wake Up Period vs. Temperature,  $R_{Delay} = 120\text{ k}\Omega$

TYPICAL CHARACTERISTICS

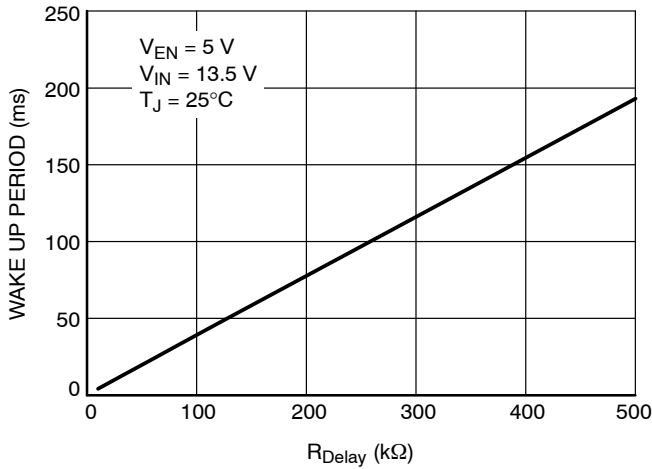

Figure 11. Wake Up Period vs.  $R_{Delay}$

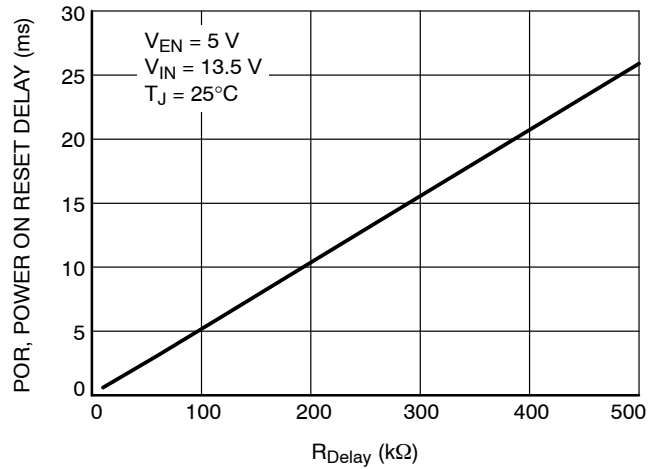

Figure 12. POR, Power On Reset Delay Time vs.  $R_{Delay}$

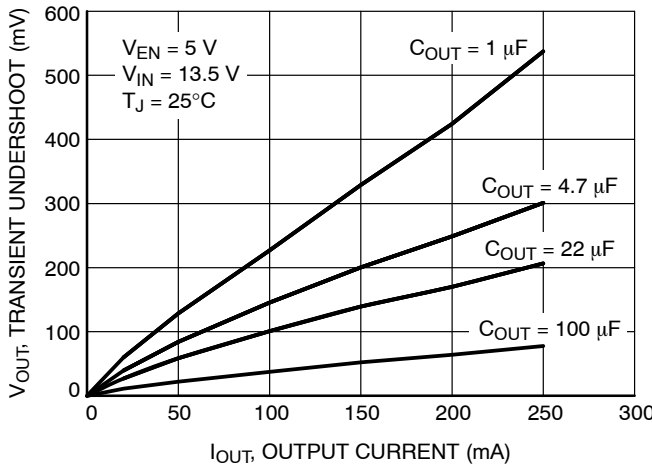

Figure 13. Load Transient Response

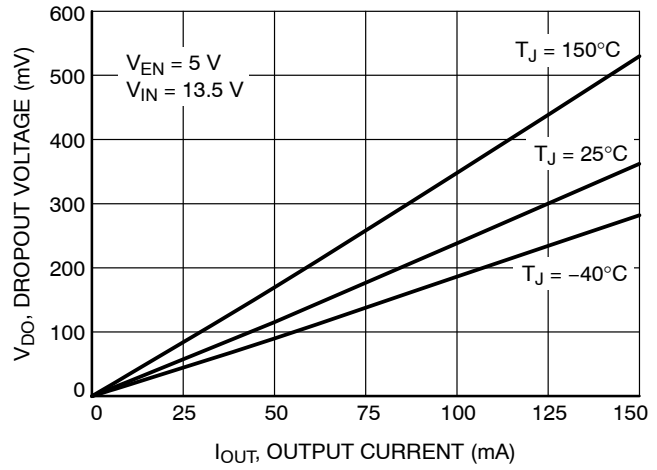

Figure 14. Dropout Voltage vs. Output Current

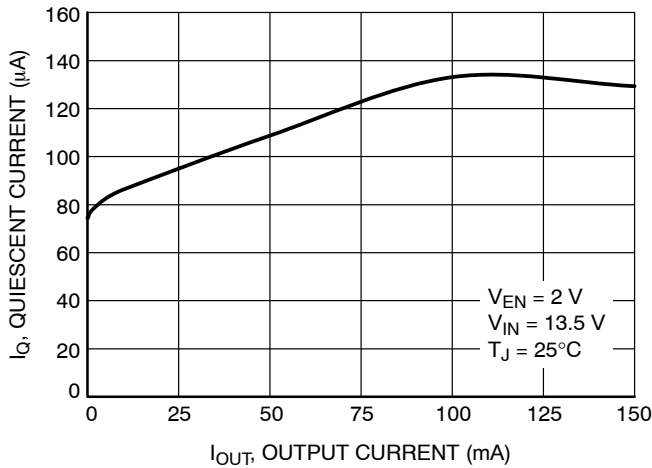

Figure 15. Quiescent Current vs. Output Current

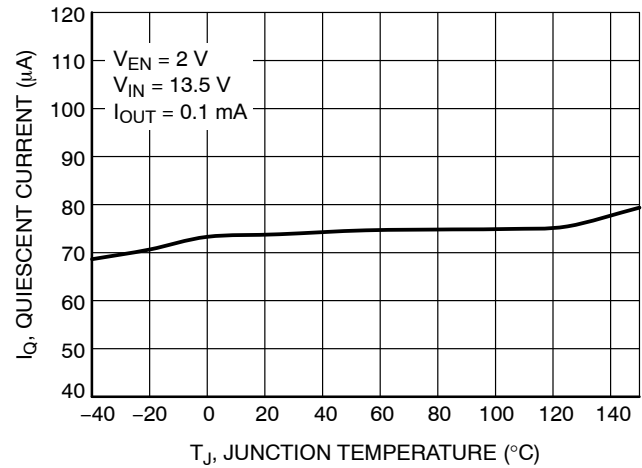

Figure 16. Quiescent Current vs. Junction Temperature

TYPICAL CHARACTERISTICS

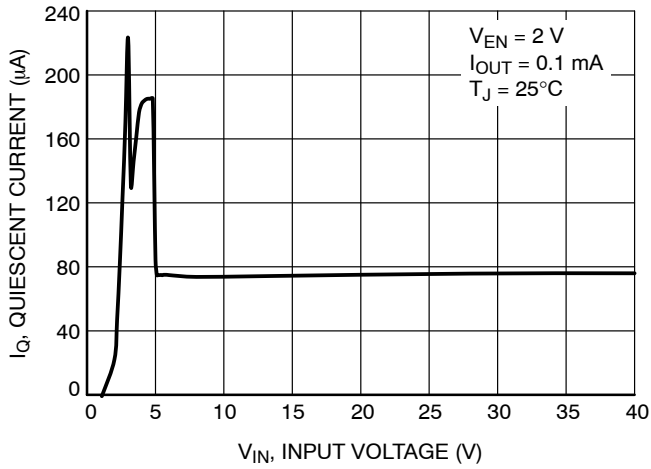

Figure 17. Quiescent Current vs. Input Voltage

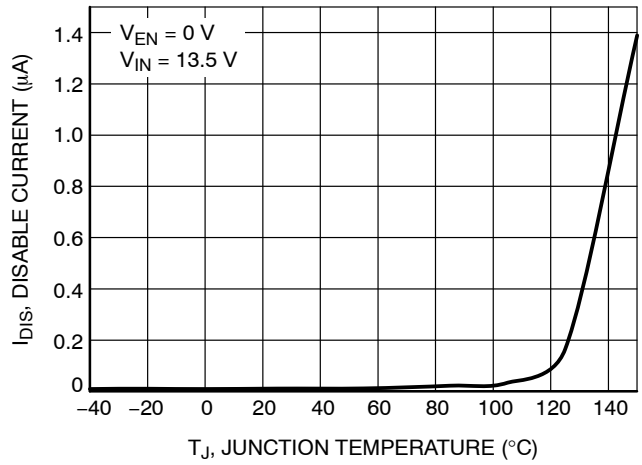

Figure 18. Disable Current vs. Junction Temperature

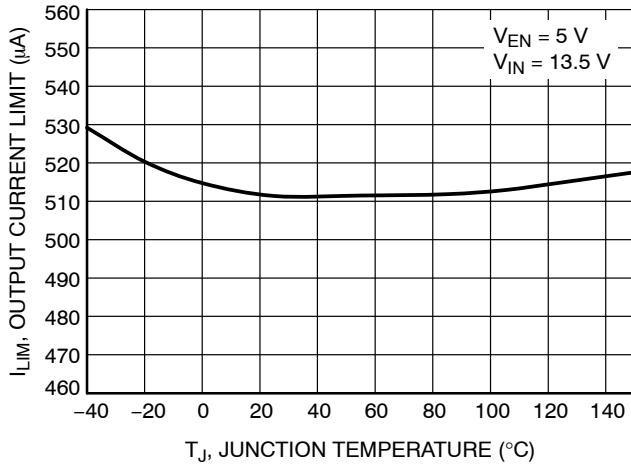

Figure 19. Output Current Limit vs. Junction Temperature

OPERATING DESCRIPTION

**General**

The NCV8518C is a precision micropower voltage regulator featuring low quiescent current (126  $\mu$ A typical at 150 mA load) and low dropout voltage (356 mV typical at 150 mA). Integrated microprocessor control functions include Watchdog, Wake Up and  $\overline{\text{RESET}}$ . An Enable input is provided for logic level control of the regulator state. The combination of low quiescent current and comprehensive microprocessor interface functions make the NCV8518C ideal for use in both battery operated and automotive applications.

The NCV8518C is internally protected against short circuit and thermal runaway conditions. No external components are required to engage these protective mechanisms. The device continues to operate through 45 volt input transients, an important consideration in automotive environments.

**Wake Up and Watchdog**

To reduce battery drain, a microprocessor or microcontroller can transition to a low current consumption (“sleep”) mode when code execution is suspended or complete. The NCV8518C Wake Up signal is generated and output periodically to interrupt sleep mode. The nominal Wake Up output is a 5 volt square wave (generated from  $V_{\text{OUT}}$ ) with a duty cycle of 50%, at a frequency determined by external timing resistor  $R_{\text{Delay}}$ . In response to the rising edge of the Wake Up signal, the microprocessor will subsequently output a Watchdog pulse and check its inputs to decide if it should resume normal operation or remain in sleep mode.

The NCV8518C responds to the falling edge of the Watchdog signal, which it expects at least once during each Wake Up period. Minimum WDI pulse width must be higher than 1  $\mu$ s and WDI falling edge must not occur during 5  $\mu$ s after Wake Up signal rising edge, otherwise WDI falling edge may not be accepted by watchdog logic. This provides higher robustness of watchdog logic against glitch pulses and disturbances in the application. When the correct Watchdog signal is received, the Wake Up output is forced low. Other Watchdog pulses received within the same cycle are ignored. The Watchdog circuitry continuously monitors the input Watchdog signal (WDI) from the microprocessor. The absence of a falling edge on the Watchdog input during one Wake Up cycle will cause a Reset pulse to be output at the end of the Wake Up cycle (see Figure 4).

**RESET**

As output voltage falls, the  $\overline{\text{RESET}}$  output will maintain its current state down to  $V_{\text{OUT}} = 1$  V. A Reset signal (active low) is asserted for any of four conditions:

1. During power up,  $\overline{\text{RESET}}$  is held low until the output voltage is in regulation.
2. During operation, if the output voltage falls below the Reset Threshold Voltage,  $\overline{\text{RESET}}$  switches low, and will remain low until both the output voltage

has recovered and the Reset delay timer cycle has completed following that recovery.

3.  $\overline{\text{RESET}}$  will switch low if the regulator does not receive a Watchdog input signal within a Wake Up period.
4. Regardless of output voltage,  $\overline{\text{RESET}}$  will switch low if the regulator input voltage  $V_{\text{IN}}$ , falls below a level required to sustain the internal control circuits. The specific voltage is temperature dependent, and is approximately 4.65 V at 20°C.

The Wake Up output is pulled low during a  $\overline{\text{RESET}}$  regardless of the cause of the  $\overline{\text{RESET}}$ . After the  $\overline{\text{RESET}}$  returns high, the Wake Up cycle begins again (see Figure 4).

The Reset Delay Time, Wake Up signal frequency and  $\overline{\text{RESET}}$  HIGH to Wake Up Rising Delay Time are all set by one external resistor,  $R_{\text{Delay}}$ , according to the following equations:

$$\text{Wake Up Period (seconds)} = (3.95 \times 10^{-7}) * R_{\text{Delay}} (\Omega)$$

$$\overline{\text{RESET}} \text{ Delay Time (seconds)} = (5.2 \times 10^{-8}) * R_{\text{Delay}} (\Omega)$$

$$\overline{\text{RESET}} \text{ HIGH to Wake Up Rising Delay Time (seconds)} = (1.96 \times 10^{-7}) * R_{\text{Delay}} (\Omega)$$

**ENABLE**

This is a standard TTL and CMOS logic compatible input that can be used to turn the regulator on or off. Logic high enables the regulator; logic low disables it (also called *shutdown*). In the disabled/shutdown state, the pass transistor is off and total quiescent current is less than 1  $\mu$ A.

**Thermal Considerations**

As power in the NCV8518C increases, it might become necessary to provide some thermal relief. The maximum power dissipation supported by the device is dependent upon board design and layout. Mounting pad configuration on the PCB, the board material and the ambient temperature affect the rate of junction temperature rise for the part. When the NCV8518C has good thermal conductivity through the PCB, the junction temperature will be relatively low with high power applications. The maximum dissipation the NCV8518C can handle is given by:

$$P_{\text{D(MAX)}} = \frac{(T_{\text{J(MAX)}} - T_{\text{A}})}{\theta_{\text{JA}}}$$

Since  $T_{\text{J}}$  is not recommended to exceed 150°C, then the NCV8518C (SOIC-8 EP) soldered on 645 mm<sup>2</sup>, 1 oz copper area, FR4 can dissipate up to 1.493 W when the ambient temperature ( $T_{\text{A}}$ ) is 25°C. See Figure 20 and 21 for  $\theta_{\text{JA}}$  versus PCB Cu area. The power dissipated by the NCV8518C can be calculated from the following equations:

$$P_{\text{D}} \approx V_{\text{in}}(I_{\text{q}}@I_{\text{out}}) + I_{\text{out}}(V_{\text{in}} - V_{\text{out}})$$

or

$$V_{\text{in(MAX)}} \approx \frac{P_{\text{D(MAX)}} + (V_{\text{out}} \times I_{\text{out}})}{I_{\text{out}} + I_{\text{q}}}$$

# NCV8518C

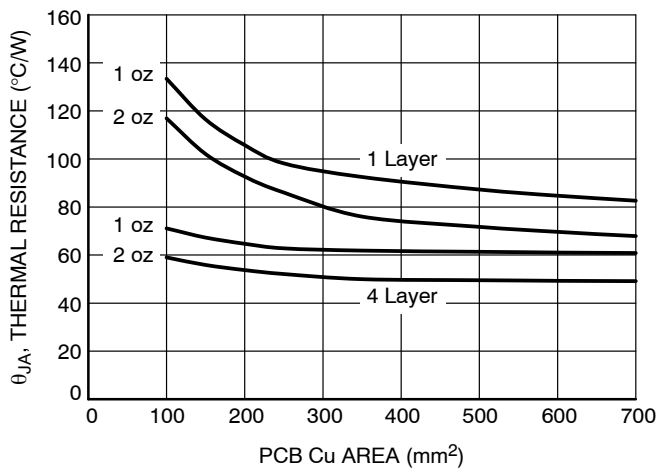

**Figure 20.  $\theta_{JA}$  vs PCB CU Area (SOIC-8 EP package)**

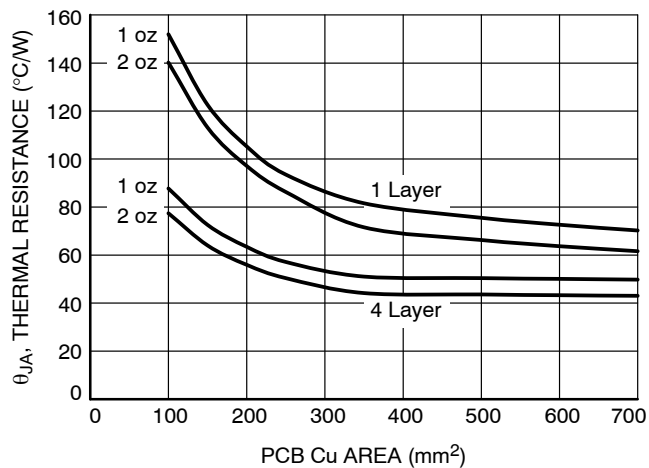
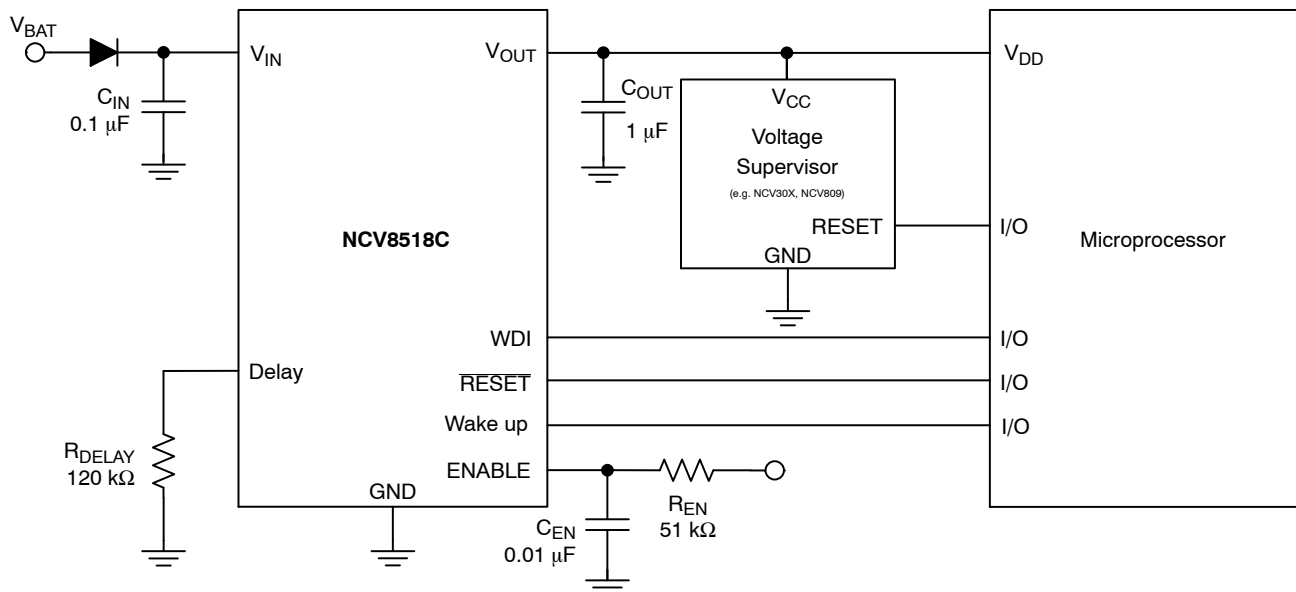

**Figure 21.  $\theta_{JA}$  vs PCB CU Area (SOIC-16 EP package)**

## Hints

$V_{in}$  and GND printed circuit board traces should be as wide as possible. When the impedance of these traces is high, there is a chance to pick up noise or cause the regulator to malfunction. Place external components, especially the output capacitor, as close as possible to the NCV8518C and make traces as short as possible.

The NCV8518C is not developed in compliance with ISO26262 standard. If application is safety critical then the below application example diagram shown in Figure 22 can be used.

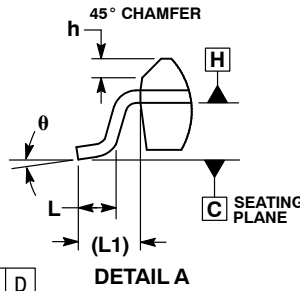
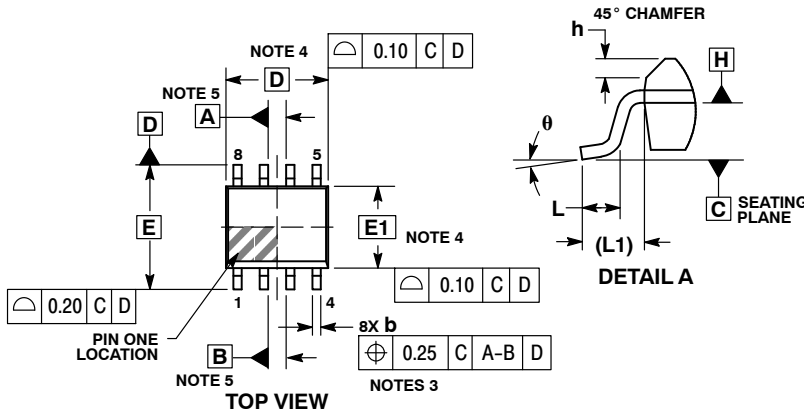

**Figure 22. Application Diagram**

# NCV8518C

## PACKAGE DIMENSIONS

### SOIC-8 EP CASE 751AC ISSUE C



**NOTES:**

1. DIMENSIONS AND TOLERANCING PER ASME Y14.5M, 1994.
2. CONTROLLING DIMENSION: MILLIMETERS
3. DIMENSION b DOES NOT INCLUDE DAMBAR PROTRUSION. ALLOWABLE DAMBAR PROTRUSION SHALL BE 0.004mm IN EXCESS OF MAXIMUM MATERIAL CONDITION.
4. DIMENSION D DOES NOT INCLUDE MOLD FLASH, PROTRUSIONS, OR GATE BURRS. MOLD FLASH, PROTRUSIONS, OR GATE BURRS SHALL NOT EXCEED 0.006mm PER SIDE. DIMENSION E1 DOES NOT INCLUDE INTERLEAD FLASH OR PROTRUSION. INTERLEAD FLASH OR PROTRUSION SHALL NOT EXCEED 0.010mm PER SIDE.
5. DATUMS A AND B TO BE DETERMINED AT DATUM PLANE H.

MILLIMETERS		
DIM	MIN	MAX
A	1.35	1.75
A1	---	0.10
A2	1.35	1.65
b	0.31	0.51
b1	0.28	0.48
c	0.17	0.25
c1	0.17	0.23
D	4.90 BSC	
E	6.00 BSC	
E1	3.90 BSC	
e	1.27 BSC	
F	2.24	3.20
G	1.55	2.51
h	0.25	0.50
L	0.40	1.27
L1	1.04 REF	
$\theta$	0°	8°

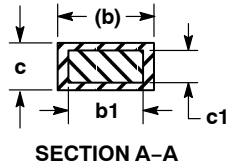
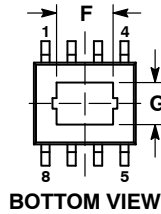
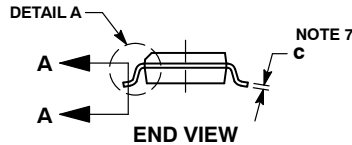
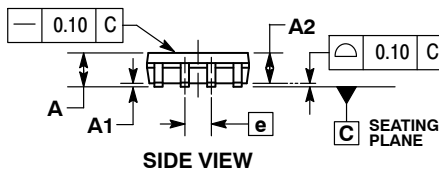

### RECOMMENDED SOLDERING FOOTPRINT\*

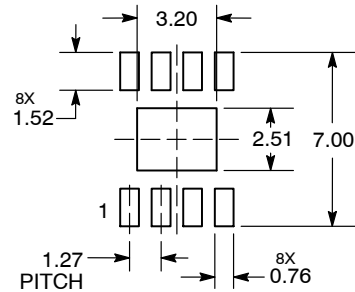

DIMENSIONS: MILLIMETERS

\*For additional information on our Pb-Free strategy and soldering details, please download the ON Semiconductor Soldering and Mounting Techniques Reference Manual, SOLDERRM/D.