

# NCV8535

## Voltage Regulator - Ultra High Accuracy, Low Iq, Low Dropout, Enable

### 500 mA

The NCV8535 is a high performance, low dropout regulator. With accuracy of  $\pm 0.9\%$  over line and load and ultra-low quiescent current and noise it encompasses all of the necessary features required by today's consumer electronics. This unique device is guaranteed to be stable without a minimum load current requirement and stable with any type of capacitor as small as 1.0  $\mu\text{F}$ . The NCV8535 also comes equipped with sense and noise reduction pins to increase the overall utility of the device. The NCV8535 offers reverse bias protection.

#### Features

- High Accuracy Over Line and Load ( $\pm 0.9\%$  at  $25^\circ\text{C}$ )
- Ultra-Low Dropout Voltage at Full Load (260 mV typ.)
- No Minimum Output Current Required for Stability
- Low Noise (31  $\mu\text{Vrms}$  w/10 nF  $C_{nr}$  and 51  $\mu\text{Vrms}$  w/out  $C_{nr}$ )
- Low Shutdown Current (0.07  $\mu\text{A}$ )
- Reverse Bias Protected
- 2.9 V to 12 V Supply Range
- Thermal Shutdown Protection
- Current Limitation
- Requires Only 1.0  $\mu\text{F}$  Output Capacitance for Stability
- Stable with Any Type of Capacitor (including MLCC)
- Available in 1.5 V, 1.8 V, 1.9 V, 2.5 V, 2.8 V, 2.85 V, 3.0 V, 3.3 V, 3.5 V, 5.0 V and Adjustable Output Voltages
- NCV Prefix for Automotive and Other Applications Requiring Unique Site and Control Change Requirements; AEC-Q100 Qualified and PPAP Capable
- These are Pb-Free Devices

#### Applications

- PCMCIA Card
- Cellular Phones
- Camcoders and Cameras
- Networking Systems, DSL/Cable Modems
- Cable Set-Top Box
- MP3/CD Players
- DSP Supply
- Displays and Monitors



ON Semiconductor®

[www.onsemi.com](http://www.onsemi.com)



DFN10  
CASE 485C



DFNW10  
CASE 507AM

#### PIN CONFIGURATION

| Fixed Version       | Adj Version         |
|---------------------|---------------------|
| Pin 1, 2. $V_{out}$ | Pin 1, 2. $V_{out}$ |
| 3. Sense            | 3. Adj              |
| 4. GND              | 4. GND              |
| 5, 6. NC            | 5, 6. NC            |
| 7. NR               | 7. NR               |
| 8. $\overline{SD}$  | 8. $\overline{SD}$  |
| 9, 10. $V_{in}$     | 9, 10. $V_{in}$     |

#### MARKING DIAGRAM

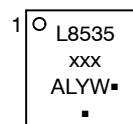
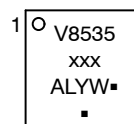

V8535 = Specific Device Code  
L8535 = Specific Device Code  
xxx = ADJ, 150, 180, 190, 250, 280, 285, 300, 330, 350, 500  
A = Assembly Location  
L = Wafer Lot  
Y = Year  
W = Work Week  
▪ = Pb-Free Package

(Note: Microdot may be in either location)

#### ORDERING INFORMATION

See detailed ordering, marking and shipping information in the package dimensions section on page 21 of this data sheet.

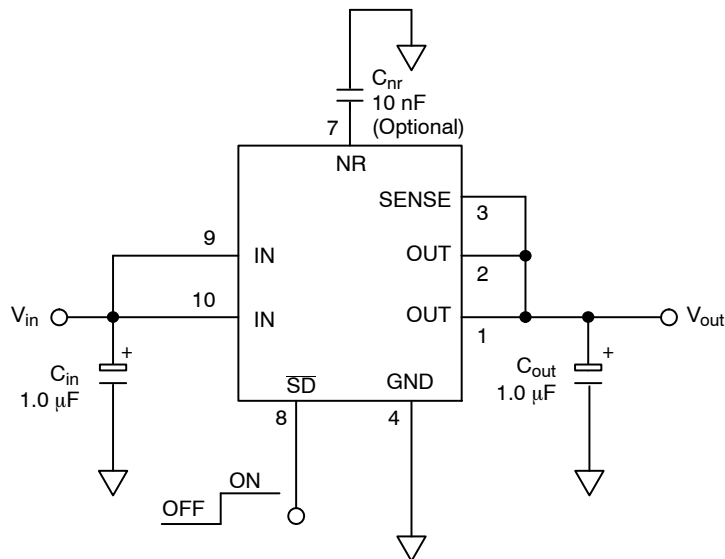

Figure 1. Typical Fixed Version Application Schematic

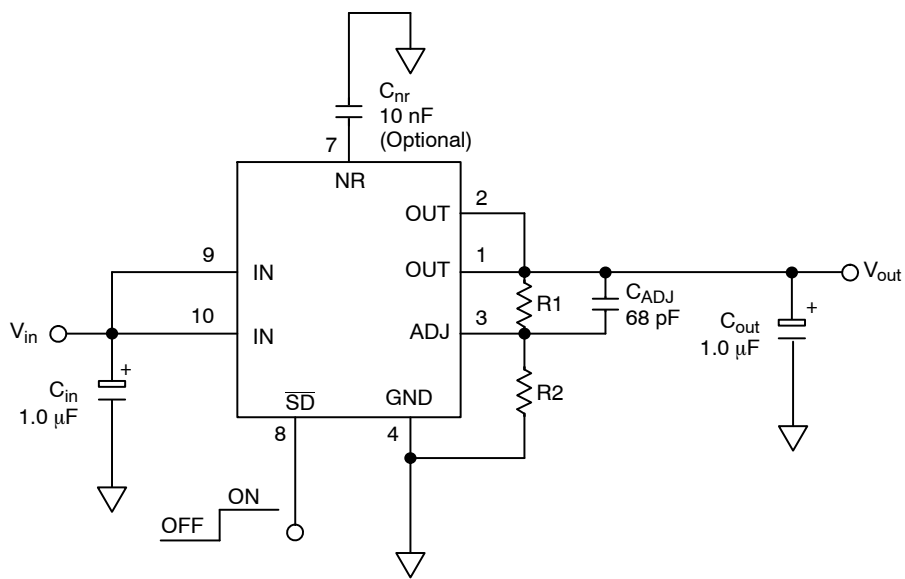

Figure 2. Typical Adjustable Version Application Schematic

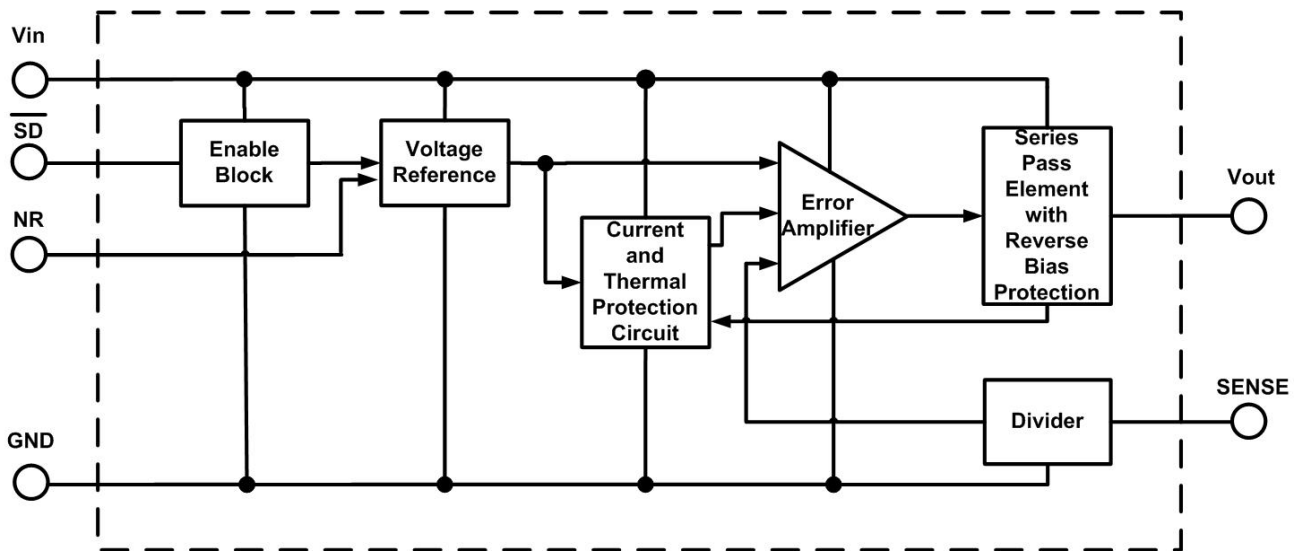

Figure 3. Block Diagram, Fixed Output Version



Figure 4. Block Diagram, Adjustable Output Version

# NCV8535

## PIN FUNCTION DESCRIPTION

| Pin No. | Pin Name | Description |
|---------|----------|-------------|
|---------|----------|-------------|

### FIXED VERSION

|       |                  |   |
|-------|------------------|---|
| 1, 2  | V <sub>out</sub> | Regulated output voltage. Bypass to ground with C <sub>out</sub> ≥ 1.0 μF.    |
| 3     | SENSE            | For output voltage sensing, connect to Pins 1 and 2.                          |
| 4     | GND              | Power Supply Ground   |
| 7     | NR               | Noise Reduction Pin. This is an optional pin used to further reduce noise.    |
| 8     | $\overline{SD}$  | Shutdown pin. When not in use, this pin should be connected to the input pin. |
| 9, 10 | V <sub>in</sub>  | Power Supply Input Voltage  |
| 5, 6  | NC               | Not Connected   |
| EPAD  | EPAD             | Exposed thermal pad should be connected to ground.                            |

### ADJUSTABLE VERSION

|       |                  |   |
|-------|------------------|---|
| 1, 2  | V <sub>out</sub> | Regulated output voltage. Bypass to ground with C <sub>out</sub> ≥ 1.0 μF.    |
| 3     | Adj              | Adjustable pin; reference voltage = 1.25 V.                                   |
| 4     | GND              | Power Supply Ground   |
| 7     | NR               | Noise Reduction Pin. This is an optional pin used to further reduce noise.    |
| 8     | $\overline{SD}$  | Shutdown pin. When not in use, this pin should be connected to the input pin. |
| 9, 10 | V <sub>in</sub>  | Power Supply Input Voltage  |
| 5, 6  | NC               | Not Connected   |
| EPAD  | EPAD             | Exposed thermal pad should be connected to ground.                            |

## MAXIMUM RATINGS

| Rating                     | Symbol           | Value                                 | Unit |
|----------------------------|------------------|---------------------------------------|------|
| Input Voltage              | V <sub>in</sub>  | -0.3 to +16                           | V    |
| Output Voltage             | V <sub>out</sub> | -0.3 to V <sub>in</sub> +0.3 or 10 V* | V    |
| Shutdown Pin Voltage       | V <sub>sh</sub>  | -0.3 to +16                           | V    |
| Junction Temperature Range | T <sub>J</sub>   | -40 to +150                           | °C   |
| Storage Temperature Range  | T <sub>stg</sub> | -55 to +150                           | °C   |

Stresses exceeding those listed in the Maximum Ratings table may damage the device. If any of these limits are exceeded, device functionality should not be assumed, damage may occur and reliability may be affected.

NOTE: This device series contains ESD protection and exceeds the following tests:

Human Body Model (HBM) tested per AEC-Q100-002 (EIA/JESD22-A114)

Machine Model (MM) tested per AEC-Q100-003 (EIA/JESD22-A115)

Charged Device Model (CDM) tested per EIA/JESD22-C101

\*Which ever is less. Reverse bias protection feature valid only if V<sub>out</sub> - V<sub>in</sub> ≤ 7 V.

## THERMAL CHARACTERISTICS

| Characteristic        | Test Conditions (Typical Value) |                       | Unit |
|-----------------------|---------------------------------|-----------------------|------|
|                       | Min Pad Board (Note 1)          | 1" Pad Board (Note 1) |      |
| Junction-to-Air, θJA  | 215                             | 66                    | °C/W |
| Junction-to-Pin, ψJL2 | 55                              | 17                    | °C/W |

1. As mounted on a 35 x 35 x 1.5 mm FR4 Substrate, with a single layer of a specified copper area of 2 oz (0.07 mm thick) copper traces and heat spreading area. JEDEC 51 specifications for a low and high conductivity test board recommend a 2 oz copper thickness. Test conditions are under natural convection or zero air flow.

# NCV8535

## ELECTRICAL CHARACTERISTICS – 5.0 V

( $V_{out} = 5.0$  V typical,  $V_{in} = 5.4$  V,  $T_A = -40^{\circ}\text{C}$  to  $+85^{\circ}\text{C}$ , unless otherwise noted, Note 2.)

| Characteristic  | Symbol   | Min            | Typ   | Max   | Unit  |
|---|--|----------------|---|---|---|
| Output Voltage (Accuracy)<br>$V_{in} = 5.4$ V to $9.0$ V, $I_{load} = 0.1$ mA to $500$ mA, $T_A = 25^{\circ}\text{C}$   | $V_{out}$  | -0.9%<br>4.955 | 5.0   | +0.9%<br>5.045                                | V   |
| Output Voltage (Accuracy)<br>$V_{in} = 5.4$ V to $9.0$ V, $I_{load} = 0.1$ mA to $500$ mA, $T_A = 0^{\circ}\text{C}$ to $+85^{\circ}\text{C}$   | $V_{out}$  | -1.4%<br>4.930 | 5.0   | +1.4%<br>5.070                                | V   |
| Output Voltage (Accuracy)<br>$V_{in} = 5.4$ V to $9.0$ V, $I_{load} = 0.1$ mA to $500$ mA, $T_A = -40^{\circ}\text{C}$ to $+125^{\circ}\text{C}$  | $V_{out}$  | -1.5%<br>4.925 | 5.0   | +1.5%<br>5.075                                | V   |
| Line Regulation<br>$V_{in} = 5.4$ V to $12$ V, $I_{load} = 0.1$ mA  | LineReg  |                | 0.04  |   | mV/V  |
| Load Regulation<br>$V_{in} = 5.4$ V, $I_{load} = 0.1$ mA to $500$ mA  | LoadReg  |                | 0.04  |   | mV/mA   |
| Dropout Voltage (See App Note)<br>$I_{load} = 500$ mA<br>$I_{load} = 300$ mA<br>$I_{load} = 50$ mA<br>$I_{load} = 0.1$ mA   | $V_{DO}$   |                |   | 340<br>230<br>110<br>10                       | mV  |
| Peak Output Current (See Figure 16)   | $I_{pk}$   | 500            | 700   | 830   | mA  |
| Short Output Current (See Figure 16)  | $I_{sc}$   |                |   | 930   | mA  |
| Thermal Shutdown  | $T_J$  |                | 160   |   | $^{\circ}\text{C}$                              |
| Ground Current<br>In Regulation<br>$I_{load} = 500$ mA (Note 3)<br>$I_{load} = 300$ mA (Note 3)<br>$I_{load} = 50$ mA<br>$I_{load} = 0.1$ mA<br><br>In Dropout<br>$V_{in} = 4.9$ V, $I_{load} = 0.1$ mA<br><br>In Shutdown<br>$S_D = 0$ V | $I_{GND}$<br><br><br><br><br><br><br><br>$I_{GNDsh}$ |                | 9.0<br>4.6<br>0.8<br>–<br><br>–<br><br>0.07 | 14<br>7.5<br>2.5<br>190<br><br>500<br><br>1.0 | mA<br><br><br><br><br><br><br><br>$\mu\text{A}$ |
| Output Noise<br>$C_{nr} = 0$ nF, $I_{load} = 500$ mA, $f = 10$ Hz to $100$ kHz, $C_{out} = 10$ $\mu\text{F}$<br>$C_{nr} = 10$ nF, $I_{load} = 500$ mA, $f = 10$ Hz to $100$ kHz, $C_{out} = 10$ $\mu\text{F}$                             | $V_{noise}$  |                | 93<br>58                                    |   | $\mu\text{Vrms}$<br>$\mu\text{Vrms}$            |
| Shutdown<br>Threshold Voltage ON<br>Threshold Voltage OFF   |  | 2.0            |   | 0.4   | V<br>V  |
| $S_D$ Input Current, $V_{SD} = 0$ V to $0.4$ V or $V_{SD} = 2.0$ V to $V_{in}$  | $I_{SD}$   |                | 0.07  | 1.0   | $\mu\text{A}$                                   |
| Output Current In Shutdown Mode, $V_{out} = 0$ V  | $I_{OSD}$  |                | 0.07  | 1.0   | $\mu\text{A}$                                   |
| Reverse Bias Protection, Current Flowing from the Output Pin to GND<br>( $V_{in} = 0$ V, $V_{out\_forced} = 5.0$ V)   | $I_{OUTR}$   |                | 10  |   | $\mu\text{A}$                                   |

- Performance guaranteed over the operating temperature range by design and/or characterization, production tested at  $T_J = T_A = 25^{\circ}\text{C}$ . Low duty cycle pulse techniques are used during testing to maintain the junction temperature as close to ambient as possible.
- $T_A$  must be greater than  $0^{\circ}\text{C}$ .

# NCV8535

## ELECTRICAL CHARACTERISTICS – 3.5 V

( $V_{out} = 3.5$  V typical,  $V_{in} = 3.9$  V,  $T_A = -40^{\circ}\text{C}$  to  $+85^{\circ}\text{C}$ , unless otherwise noted, Note 4.)

| Characteristic   | Symbol   | Min            | Typ   | Max   | Unit  |
|--|--|----------------|---|---|---|
| Output Voltage (Accuracy)<br>$V_{in} = 3.9$ V to $7.5$ V, $I_{load} = 0.1$ mA to $500$ mA, $T_A = 25^{\circ}\text{C}$  | $V_{out}$  | -0.9%<br>3.469 | 3.5   | +0.9%<br>3.532                                | V   |
| Output Voltage (Accuracy)<br>$V_{in} = 3.9$ V to $7.5$ V, $I_{load} = 0.1$ mA to $500$ mA, $T_A = 0^{\circ}\text{C}$ to $+85^{\circ}\text{C}$  | $V_{out}$  | -1.4%<br>3.451 | 3.5   | +1.4%<br>3.549                                | V   |
| Output Voltage (Accuracy)<br>$V_{in} = 3.9$ V to $7.5$ V, $I_{load} = 0.1$ mA to $500$ mA, $T_A = -40^{\circ}\text{C}$ to $+125^{\circ}\text{C}$   | $V_{out}$  | -1.5%<br>3.448 | 3.5   | +1.5%<br>3.553                                | V   |
| Line Regulation<br>$V_{in} = 3.9$ V to $12$ V, $I_{load} = 0.1$ mA   | LineReg  |                | 0.04  |   | mV/V  |
| Load Regulation<br>$V_{in} = 3.9$ V, $I_{load} = 0.1$ mA to $500$ mA   | LoadReg  |                | 0.04  |   | mV/mA   |
| Dropout Voltage (See App Note)<br>$I_{load} = 500$ mA<br>$I_{load} = 300$ mA<br>$I_{load} = 50$ mA<br>$I_{load} = 0.1$ mA  | $V_{DO}$   |                |   | 340<br>230<br>110<br>10                       | mV  |
| Peak Output Current (See Figure 16)  | $I_{pk}$   | 500            | 700   | 800   | mA  |
| Short Output Current (See Figure 16)   | $I_{sc}$   |                |   | 900   | mA  |
| Thermal Shutdown   | $T_J$  |                | 160   |   | $^{\circ}\text{C}$                              |
| Ground Current<br>In Regulation<br>$I_{load} = 500$ mA (Note 5)<br>$I_{load} = 300$ mA<br>$I_{load} = 50$ mA<br>$I_{load} = 0.1$ mA<br><br>In Dropout<br>$V_{in} = 3.4$ V, $I_{load} = 0.1$ mA<br><br>In Shutdown<br>$S_D = 0$ V | $I_{GND}$<br><br><br><br><br><br><br><br>$I_{GNDsh}$ |                | 9.0<br>4.6<br>0.8<br>–<br><br>–<br><br>0.07 | 14<br>7.5<br>2.5<br>190<br><br>500<br><br>1.0 | mA<br><br><br><br><br><br><br><br>$\mu\text{A}$ |
| Output Noise<br>$C_{nr} = 0$ nF, $I_{load} = 500$ mA, $f = 10$ Hz to $100$ kHz, $C_{out} = 10$ $\mu\text{F}$<br>$C_{nr} = 10$ nF, $I_{load} = 500$ mA, $f = 10$ Hz to $100$ kHz, $C_{out} = 10$ $\mu\text{F}$                    | $V_{noise}$  |                | 68<br>47                                    |   | $\mu\text{Vrms}$<br>$\mu\text{Vrms}$            |
| Shutdown<br>Threshold Voltage ON<br>Threshold Voltage OFF  |  | 2.0            |   | 0.4   | V<br>V  |
| $S_D$ Input Current, $V_{SD} = 0$ V to $0.4$ V or $V_{SD} = 2.0$ V to $V_{in}$   | $I_{SD}$   |                | 0.07  | 1.0   | $\mu\text{A}$                                   |
| Output Current In Shutdown Mode, $V_{out} = 0$ V   | $I_{OSD}$  |                | 0.07  | 1.0   | $\mu\text{A}$                                   |
| Reverse Bias Protection, Current Flowing from the Output Pin to GND<br>( $V_{in} = 0$ V, $V_{out\_forced} = 3.5$ V)  | $I_{OUTR}$   |                | 10  |   | $\mu\text{A}$                                   |

- Performance guaranteed over the operating temperature range by design and/or characterization, production tested at  $T_J = T_A = 25^{\circ}\text{C}$ . Low duty cycle pulse techniques are used during testing to maintain the junction temperature as close to ambient as possible.
- $T_A$  must be greater than  $0^{\circ}\text{C}$ .

# NCV8535

## ELECTRICAL CHARACTERISTICS – 3.3 V

( $V_{out} = 3.3$  V typical,  $V_{in} = 3.7$  V,  $T_A = -40^{\circ}\text{C}$  to  $+85^{\circ}\text{C}$ , unless otherwise noted, Note 6.)

| Characteristic   | Symbol      | Min            | Typ                    | Max                     | Unit                                 |
|--|-------------|----------------|------------------------|-------------------------|--------------------------------------|
| Output Voltage (Accuracy)<br>$V_{in} = 3.7$ V to $7.3$ V, $I_{load} = 0.1$ mA to $500$ mA, $T_A = 25^{\circ}\text{C}$  | $V_{out}$   | -0.9%<br>3.270 | 3.3                    | +0.9%<br>3.330          | V                                    |
| Output Voltage (Accuracy)<br>$V_{in} = 3.7$ V to $7.3$ V, $I_{load} = 0.1$ mA to $500$ mA, $T_A = 0^{\circ}\text{C}$ to $+85^{\circ}\text{C}$  | $V_{out}$   | -1.4%<br>3.254 | 3.3                    | +1.4%<br>3.346          | V                                    |
| Output Voltage (Accuracy)<br>$V_{in} = 3.7$ V to $7.3$ V, $I_{load} = 0.1$ mA to $500$ mA, $T_A = -40^{\circ}\text{C}$ to $+125^{\circ}\text{C}$   | $V_{out}$   | -1.5%<br>3.250 | 3.3                    | +1.5%<br>3.350          | V                                    |
| Line Regulation<br>$V_{in} = 3.7$ V to $12$ V, $I_{load} = 0.1$ mA   | LineReg     |                | 0.04                   |                         | mV/V                                 |
| Load Regulation<br>$V_{in} = 3.7$ V, $I_{load} = 0.1$ mA to $500$ mA   | LoadReg     |                | 0.04                   |                         | mV/mA                                |
| Dropout Voltage (See App Note)<br>$I_{load} = 500$ mA<br>$I_{load} = 300$ mA<br>$I_{load} = 50$ mA<br>$I_{load} = 0.1$ mA  | $V_{DO}$    |                |                        | 340<br>230<br>110<br>10 | mV                                   |
| Peak Output Current (See Figure 16)  | $I_{pk}$    | 500            | 700                    | 800                     | mA                                   |
| Short Output Current (See Figure 16)   | $I_{sc}$    |                |                        | 900                     | mA                                   |
| Thermal Shutdown   | $T_J$       |                | 160                    |                         | $^{\circ}\text{C}$                   |
| Ground Current<br>In Regulation<br>$I_{load} = 500$ mA (Note 7)<br>$I_{load} = 300$ mA<br>$I_{load} = 50$ mA<br>$I_{load} = 0.1$ mA<br><br>In Dropout<br>$V_{in} = 3.2$ V, $I_{load} = 0.1$ mA<br><br>In Shutdown<br>$S_D = 0$ V | $I_{GND}$   |                | 9.0<br>4.6<br>0.8<br>– | 14<br>7.5<br>2.5<br>190 | mA<br><br><br>$\mu\text{A}$          |
| Output Noise<br>$C_{nr} = 0$ nF, $I_{load} = 500$ mA, $f = 10$ Hz to $100$ kHz, $C_{out} = 10$ $\mu\text{F}$<br>$C_{nr} = 10$ nF, $I_{load} = 500$ mA, $f = 10$ Hz to $100$ kHz, $C_{out} = 10$ $\mu\text{F}$                    | $V_{noise}$ |                | 69<br>46               |                         | $\mu\text{Vrms}$<br>$\mu\text{Vrms}$ |
| Shutdown<br>Threshold Voltage ON<br>Threshold Voltage OFF  |             | 2.0            |                        | 0.4                     | V<br>V                               |
| $S_D$ Input Current, $V_{SD} = 0$ V to $0.4$ V or $V_{SD} = 2.0$ V to $V_{in}$   | $I_{SD}$    |                | 0.07                   | 1.0                     | $\mu\text{A}$                        |
| Output Current In Shutdown Mode, $V_{out} = 0$ V   | $I_{OSD}$   |                | 0.07                   | 1.0                     | $\mu\text{A}$                        |
| Reverse Bias Protection, Current Flowing from the Output Pin to GND<br>( $V_{in} = 0$ V, $V_{out\_forced} = 3.3$ V)  | $I_{OUTR}$  |                | 10                     |                         | $\mu\text{A}$                        |

6. Performance guaranteed over the operating temperature range by design and/or characterization, production tested at  $T_J = T_A = 25^{\circ}\text{C}$ . Low duty cycle pulse techniques are used during testing to maintain the junction temperature as close to ambient as possible.

7.  $T_A$  must be greater than  $0^{\circ}\text{C}$ .

**ELECTRICAL CHARACTERISTICS – 3.0 V**

( $V_{out} = 3.0\text{ V}$  typical,  $V_{in} = 3.4\text{ V}$ ,  $T_A = -40^\circ\text{C}$  to  $+85^\circ\text{C}$ , unless otherwise noted, Note 8.)

| Characteristic  | Symbol   | Min            | Typ   | Max   | Unit  |
|---|--|----------------|---|---|---|
| Output Voltage (Accuracy)<br>$V_{in} = 3.4\text{ V}$ to $7.0\text{ V}$ , $I_{load} = 0.1\text{ mA}$ to $500\text{ mA}$ , $T_A = 25^\circ\text{C}$   | $V_{out}$  | -0.9%<br>2.973 | 3.0   | +0.9%<br>3.027                                | V   |
| Output Voltage (Accuracy)<br>$V_{in} = 3.4\text{ V}$ to $7.0\text{ V}$ , $I_{load} = 0.1\text{ mA}$ to $500\text{ mA}$ , $T_A = 0^\circ\text{C}$ to $+85^\circ\text{C}$   | $V_{out}$  | -1.4%<br>2.958 | 3.0   | +1.4%<br>3.042                                | V   |
| Output Voltage (Accuracy)<br>$V_{in} = 3.4\text{ V}$ to $7.0\text{ V}$ , $I_{load} = 0.1\text{ mA}$ to $500\text{ mA}$ , $T_A = -40^\circ\text{C}$ to $+125^\circ\text{C}$  | $V_{out}$  | -1.5%<br>2.955 | 3.0   | +1.5%<br>3.045                                | V   |
| Line Regulation<br>$V_{in} = 3.4\text{ V}$ to $12\text{ V}$ , $I_{load} = 0.1\text{ mA}$  | LineReg  |                | 0.04  |   | mV/V  |
| Load Regulation<br>$V_{in} = 3.4\text{ V}$ , $I_{load} = 0.1\text{ mA}$ to $500\text{ mA}$  | LoadReg  |                | 0.04  |   | mV/mA   |
| Dropout Voltage (See App Note)<br>$I_{load} = 500\text{ mA}$<br>$I_{load} = 300\text{ mA}$<br>$I_{load} = 50\text{ mA}$<br>$I_{load} = 0.1\text{ mA}$   | $V_{DO}$   |                |   | 340<br>230<br>110<br>10                       | mV  |
| Peak Output Current (See Figure 16)   | $I_{pk}$   | 500            | 700   | 800   | mA  |
| Short Output Current (See Figure 16)  | $I_{sc}$   |                |   | 900   | mA  |
| Thermal Shutdown  | $T_J$  |                | 160   |   | $^\circ\text{C}$                                |
| Ground Current<br>In Regulation<br>$I_{load} = 500\text{ mA}$ (Note 9)<br>$I_{load} = 300\text{ mA}$<br>$I_{load} = 50\text{ mA}$<br>$I_{load} = 0.1\text{ mA}$<br><br>In Dropout<br>$V_{in} = 2.9\text{ V}$ , $I_{load} = 0.1\text{ mA}$<br><br>In Shutdown<br>$S_D = 0\text{ V}$    | $I_{GND}$<br><br><br><br><br><br><br><br>$I_{GNDsh}$ |                | 9.0<br>4.6<br>0.8<br>–<br><br>–<br><br>0.07 | 14<br>7.5<br>2.5<br>190<br><br>500<br><br>1.0 | mA<br><br><br><br><br><br><br><br>$\mu\text{A}$ |
| Output Noise<br>$C_{nr} = 0\text{ nF}$ , $I_{load} = 500\text{ mA}$ , $f = 10\text{ Hz}$ to $100\text{ kHz}$ , $C_{out} = 10\text{ }\mu\text{F}$<br>$C_{nr} = 10\text{ nF}$ , $I_{load} = 500\text{ mA}$ , $f = 10\text{ Hz}$ to $100\text{ kHz}$ , $C_{out} = 10\text{ }\mu\text{F}$ | $V_{noise}$  |                | 56<br>37                                    |   | $\mu\text{Vrms}$<br>$\mu\text{Vrms}$            |
| Shutdown<br>Threshold Voltage ON<br>Threshold Voltage OFF   |  | 2.0            |   | 0.4   | V<br>V  |
| $S_D$ Input Current, $V_{SD} = 0\text{ V}$ to $0.4\text{ V}$ or $V_{SD} = 2.0\text{ V}$ to $V_{in}$   | $I_{SD}$   |                | 0.07  | 1.0   | $\mu\text{A}$                                   |
| Output Current In Shutdown Mode, $V_{out} = 0\text{ V}$   | $I_{OSD}$  |                | 0.07  | 1.0   | $\mu\text{A}$                                   |
| Reverse Bias Protection, Current Flowing from the Output Pin to GND<br>( $V_{in} = 0\text{ V}$ , $V_{out\_forced} = 3.0\text{ V}$ )   | $I_{OUTR}$   |                | 10  |   | $\mu\text{A}$                                   |

8. Performance guaranteed over the operating temperature range by design and/or characterization, production tested at  $T_J = T_A = 25^\circ\text{C}$ . Low duty cycle pulse techniques are used during testing to maintain the junction temperature as close to ambient as possible.

9.  $T_A$  must be greater than  $0^\circ\text{C}$ .



# NCV8535

## ELECTRICAL CHARACTERISTICS – 2.85 V

( $V_{out} = 2.85$  V typical,  $V_{in} = 3.25$  V,  $T_A = -40^{\circ}\text{C}$  to  $+85^{\circ}\text{C}$ , unless otherwise noted, Note 10)

| Characteristic   | Symbol      | Min            | Typ                    | Max                     | Unit                                 |
|--|-------------|----------------|------------------------|-------------------------|--------------------------------------|
| Output Voltage (Accuracy)<br>$V_{in} = 3.25$ V to $6.85$ V, $I_{load} = 0.1$ mA to $500$ mA, $T_A = 25^{\circ}\text{C}$  | $V_{out}$   | -0.9%<br>2.824 | 2.85                   | +0.9%<br>2.876          | V                                    |
| Output Voltage (Accuracy)<br>$V_{in} = 3.25$ V to $6.85$ V, $I_{load} = 0.1$ mA to $500$ mA, $T_A = 0^{\circ}\text{C}$ to $+85^{\circ}\text{C}$  | $V_{out}$   | -1.4%<br>2.810 | 2.85                   | +1.4%<br>2.890          | V                                    |
| Output Voltage (Accuracy) (Note 11)<br>$V_{in} = 3.25$ V to $6.85$ V, $I_{load} = 0.1$ mA to $500$ mA, $T_A = -40^{\circ}\text{C}$ to $+125^{\circ}\text{C}$   | $V_{out}$   | -1.5%<br>2.807 | 2.85                   | +1.5%<br>2.893          | V                                    |
| Line Regulation<br>$V_{in} = 3.25$ V to $12$ V, $I_{load} = 0.1$ mA  | LineReg     |                | 0.04                   |                         | mV/V                                 |
| Load Regulation<br>$V_{in} = 3.25$ V, $I_{load} = 0.1$ mA to $500$ mA  | LoadReg     |                | 0.04                   |                         | mV/mA                                |
| Dropout Voltage (See App Note)<br>$I_{load} = 500$ mA<br>$I_{load} = 300$ mA<br>$I_{load} = 50$ mA<br>$I_{load} = 0.1$ mA  | $V_{DO}$    |                |                        | 340<br>230<br>110<br>10 | mV                                   |
| Peak Output Current (See Figure 16)  | $I_{pk}$    | 500            | 700                    | 800                     | mA                                   |
| Short Output Current (See Figure 16)   | $I_{sc}$    |                |                        | 900                     | mA                                   |
| Thermal Shutdown   | $T_J$       |                | 160                    |                         | $^{\circ}\text{C}$                   |
| Ground Current<br>In Regulation<br>$I_{load} = 500$ mA (Note 12)<br>$I_{load} = 300$ mA<br>$I_{load} = 50$ mA<br>$I_{load} = 0.1$ mA<br><br>In Dropout<br>$V_{in} = 2.75$ V, $I_{load} = 0.1$ mA<br><br>In Shutdown<br>$S_D = 0$ V | $I_{GND}$   |                | 9.0<br>4.6<br>0.8<br>– | 14<br>7.5<br>2.5<br>190 | mA<br><br><br>$\mu\text{A}$          |
| Output Noise<br>$C_{nr} = 0$ nF, $I_{load} = 500$ mA, $f = 10$ Hz to $100$ kHz, $C_{out} = 10$ $\mu\text{F}$<br>$C_{nr} = 10$ nF, $I_{load} = 500$ mA, $f = 10$ Hz to $100$ kHz, $C_{out} = 10$ $\mu\text{F}$                      | $V_{noise}$ |                | 61<br>40               |                         | $\mu\text{Vrms}$<br>$\mu\text{Vrms}$ |
| Shutdown<br>Threshold Voltage ON<br>Threshold Voltage OFF  |             | 2.0            |                        | 0.4                     | V<br>V                               |
| $S_D$ Input Current, $V_{SD} = 0$ V to $0.4$ V or $V_{SD} = 2.0$ V to $V_{in}$   | $I_{SD}$    |                | 0.07                   | 1.0                     | $\mu\text{A}$                        |
| Output Current In Shutdown Mode, $V_{out} = 0$ V   | $I_{OSD}$   |                | 0.07                   | 1.0                     | $\mu\text{A}$                        |
| Reverse Bias Protection, Current Flowing from the Output Pin to GND<br>( $V_{in} = 0$ V, $V_{out\_forced} = 2.85$ V)   | $I_{OUTR}$  |                | 10                     |                         | $\mu\text{A}$                        |

10. Performance guaranteed over the operating temperature range by design and/or characterization, production tested at  $T_J = T_A = 25^{\circ}\text{C}$ . Low duty cycle pulse techniques are used during testing to maintain the junction temperature as close to ambient as possible.

11. For output current capability for  $T_A < 0^{\circ}\text{C}$ , please refer to Figure 18.

12.  $T_A$  must be greater than  $0^{\circ}\text{C}$ .

**ELECTRICAL CHARACTERISTICS – 2.8 V**

( $V_{out} = 2.8\text{ V}$  typical,  $V_{in} = 3.2\text{ V}$ ,  $T_A = -40^\circ\text{C}$  to  $+85^\circ\text{C}$ , unless otherwise noted, Note 13.)

| Characteristic  | Symbol   | Min            | Typ   | Max   | Unit  |
|---|--|----------------|---|---|---|
| Output Voltage (Accuracy)<br>$V_{in} = 3.2\text{ V}$ to $6.8\text{ V}$ , $I_{load} = 0.1\text{ mA}$ to $500\text{ mA}$ , $T_A = 25^\circ\text{C}$   | $V_{out}$  | -0.9%<br>2.774 | 2.8   | +0.9%<br>2.826                                | V   |
| Output Voltage (Accuracy)<br>$V_{in} = 3.2\text{ V}$ to $6.8\text{ V}$ , $I_{load} = 0.1\text{ mA}$ to $500\text{ mA}$ , $T_A = 0^\circ\text{C}$ to $+85^\circ\text{C}$   | $V_{out}$  | -1.4%<br>2.760 | 2.8   | +1.4%<br>2.840                                | V   |
| Output Voltage (Accuracy) (Note 14)<br>$V_{in} = 3.2\text{ V}$ to $6.8\text{ V}$ , $I_{load} = 0.1\text{ mA}$ to $500\text{ mA}$ , $T_A = -40^\circ\text{C}$ to $+125^\circ\text{C}$  | $V_{out}$  | -1.5%<br>2.758 | 2.8   | +1.5%<br>2.842                                | V   |
| Line Regulation<br>$V_{in} = 3.2\text{ V}$ to $12\text{ V}$ , $I_{load} = 0.1\text{ mA}$  | LineReg  |                | 0.04  |   | mV/V  |
| Load Regulation<br>$V_{in} = 3.2\text{ V}$ , $I_{load} = 0.1\text{ mA}$ to $500\text{ mA}$  | LoadReg  |                | 0.04  |   | mV/mA   |
| Dropout Voltage (See App Note)<br>$I_{load} = 500\text{ mA}$<br>$I_{load} = 300\text{ mA}$<br>$I_{load} = 50\text{ mA}$<br>$I_{load} = 0.1\text{ mA}$   | $V_{DO}$   |                |   | 340<br>230<br>110<br>10                       | mV  |
| Peak Output Current (See Figure 16)   | $I_{pk}$   | 500            | 700   | 800   | mA  |
| Short Output Current (See Figure 16)  | $I_{sc}$   |                |   | 900   | mA  |
| Thermal Shutdown  | $T_J$  |                | 160   |   | $^\circ\text{C}$                                |
| Ground Current<br>In Regulation<br>$I_{load} = 500\text{ mA}$ (Note 15)<br>$I_{load} = 300\text{ mA}$ (Note 15)<br>$I_{load} = 50\text{ mA}$<br>$I_{load} = 0.1\text{ mA}$<br><br>In Dropout<br>$V_{in} = 2.7\text{ V}$ , $I_{load} = 0.1\text{ mA}$<br><br>In Shutdown<br>$S_D = 0\text{ V}$ | $I_{GND}$<br><br><br><br><br><br><br><br>$I_{GNDsh}$ |                | 9.0<br>4.6<br>0.8<br>–<br><br>–<br><br>0.07 | 14<br>7.5<br>2.5<br>190<br><br>500<br><br>1.0 | mA<br><br><br><br><br><br><br><br>$\mu\text{A}$ |
| Output Noise<br>$C_{nr} = 0\text{ nF}$ , $I_{load} = 500\text{ mA}$ , $f = 10\text{ Hz}$ to $100\text{ kHz}$ , $C_{out} = 10\text{ }\mu\text{F}$<br>$C_{nr} = 10\text{ nF}$ , $I_{load} = 500\text{ mA}$ , $f = 10\text{ Hz}$ to $100\text{ kHz}$ , $C_{out} = 10\text{ }\mu\text{F}$         | $V_{noise}$  |                | 52<br>36                                    |   | $\mu\text{Vrms}$<br>$\mu\text{Vrms}$            |
| Shutdown<br>Threshold Voltage ON<br>Threshold Voltage OFF   |  | 2.0            |   | 0.4   | V<br>V  |
| $S_D$ Input Current, $V_{SD} = 0\text{ V}$ to $0.4\text{ V}$ or $V_{SD} = 2.0\text{ V}$ to $V_{in}$   | $I_{SD}$   |                | 0.07  | 1.0   | $\mu\text{A}$                                   |
| Output Current In Shutdown Mode, $V_{out} = 0\text{ V}$   | $I_{OSD}$  |                | 0.07  | 1.0   | $\mu\text{A}$                                   |
| Reverse Bias Protection, Current Flowing from the Output Pin to GND<br>( $V_{in} = 0\text{ V}$ , $V_{out\_forced} = 2.8\text{ V}$ )   | $I_{OUTR}$   |                | 10  |   | $\mu\text{A}$                                   |

13. Performance guaranteed over the operating temperature range by design and/or characterization, production tested at  $T_J = T_A = 25^\circ\text{C}$ . Low duty cycle pulse techniques are used during testing to maintain the junction temperature as close to ambient as possible.

14. For output current capability for  $T_A < 0^\circ\text{C}$ , please refer to Figure 19.

15.  $T_A$  must be greater than  $0^\circ\text{C}$ .

**ELECTRICAL CHARACTERISTICS – 2.5 V**

( $V_{out} = 2.5$  V typical,  $V_{in} = 2.9$  V,  $T_A = -40^{\circ}\text{C}$  to  $+85^{\circ}\text{C}$ , unless otherwise noted, Note 16.)

| Characteristic  | Symbol   | Min            | Typ                    | Max                                | Unit  |
|---|--|----------------|------------------------|------------------------------------|---|
| Output Voltage (Accuracy)<br>$V_{in} = 2.9$ V to $6.5$ V, $I_{load} = 0.1$ mA to $500$ mA, $T_A = 25^{\circ}\text{C}$   | $V_{out}$  | -0.9%<br>2.477 | 2.5                    | +0.9%<br>2.523                     | V   |
| Output Voltage (Accuracy)<br>$V_{in} = 2.9$ V to $6.5$ V, $I_{load} = 0.1$ mA to $500$ mA, $T_A = 0^{\circ}\text{C}$ to $+85^{\circ}\text{C}$   | $V_{out}$  | -1.4%<br>2.465 | 2.5                    | +1.4%<br>2.535                     | V   |
| Output Voltage (Accuracy), (Note 17)<br>$V_{in} = 2.9$ V to $6.5$ V, $I_{load} = 0.1$ mA to $500$ mA, $T_A = -40^{\circ}\text{C}$ to $+125^{\circ}\text{C}$   | $V_{out}$  | -1.5%<br>2.462 | 2.5                    | +1.5%<br>2.538                     | V   |
| Line Regulation<br>$V_{in} = 2.9$ V to $12$ V, $I_{load} = 0.1$ mA  | LineReg  |                | 0.04                   |                                    | mV/V  |
| Load Regulation<br>$V_{in} = 2.9$ V, $I_{load} = 0.1$ mA to $500$ mA  | LoadReg  |                | 0.04                   |                                    | mV/mA   |
| Dropout Voltage (See App Note)<br>$I_{load} = 500$ mA (Note 18)<br>$I_{load} = 300$ mA (Note 18)<br>$I_{load} = 50$ mA<br>$I_{load} = 0.1$ mA   | $V_{DO}$   |                |                        | 340<br>230<br>110<br>10            | mV  |
| Peak Output Current (See Figure 16)   | $I_{pk}$   | 500            | 700                    | 800                                | mA  |
| Short Output Current (See Figure 16)  | $I_{sc}$   |                |                        | 900                                | mA  |
| Thermal Shutdown  | $T_J$  |                | 160                    |                                    | $^{\circ}\text{C}$                              |
| Ground Current<br>In Regulation<br>$I_{load} = 500$ mA (Note 18)<br>$I_{load} = 300$ mA (Note 18)<br>$I_{load} = 50$ mA<br>$I_{load} = 0.1$ mA<br><br>In Dropout<br>$V_{in} = 2.4$ V, $I_{load} = 0.1$ mA<br><br>In Shutdown<br>$S_D = 0$ V | $I_{GND}$<br><br><br><br><br><br><br><br>$I_{GNDsh}$ |                | 9.0<br>4.6<br>0.8<br>– | 14<br>7.5<br>2.5<br>190<br><br>500 | mA<br><br><br><br><br><br><br><br>$\mu\text{A}$ |
| Output Noise<br>$C_{nr} = 0$ nF, $I_{load} = 500$ mA, $f = 10$ Hz to $100$ kHz, $C_{out} = 10$ $\mu\text{F}$<br>$C_{nr} = 10$ nF, $I_{load} = 500$ mA, $f = 10$ Hz to $100$ kHz, $C_{out} = 10$ $\mu\text{F}$                               | $V_{noise}$  |                | 56<br>35               |                                    | $\mu\text{Vrms}$<br>$\mu\text{Vrms}$            |
| Shutdown<br>Threshold Voltage ON<br>Threshold Voltage OFF   |  | 2.0            |                        | 0.4                                | V<br>V  |
| $S_D$ Input Current, $V_{SD} = 0$ V to $0.4$ V or $V_{SD} = 2.0$ V to $V_{in}$  | $I_{SD}$   |                | 0.07                   | 1.0                                | $\mu\text{A}$                                   |
| Output Current In Shutdown Mode, $V_{out} = 0$ V  | $I_{OSD}$  |                | 0.07                   | 1.0                                | $\mu\text{A}$                                   |
| Reverse Bias Protection, Current Flowing from the Output Pin to GND<br>( $V_{in} = 0$ V, $V_{out\_forced} = 2.5$ V)   | $I_{OUTR}$   |                | 10                     |                                    | $\mu\text{A}$                                   |

16. Performance guaranteed over the operating temperature range by design and/or characterization, production tested at  $T_J = T_A = 25^{\circ}\text{C}$ . Low duty cycle pulse techniques are used during testing to maintain the junction temperature as close to ambient as possible.

17. For output current capability for  $T_A < 0^{\circ}\text{C}$ , please refer to Figure 20.

18.  $T_A$  must be greater than  $0^{\circ}\text{C}$ .

**ELECTRICAL CHARACTERISTICS – 1.9 V**

( $V_{out} = 1.9\text{ V}$  typical,  $V_{in} = 2.9\text{ V}$ ,  $T_A = -40^\circ\text{C}$  to  $+85^\circ\text{C}$ , unless otherwise noted, Note 19.)

| Characteristic  | Symbol   | Min            | Typ                    | Max                                | Unit  |
|---|--|----------------|------------------------|------------------------------------|---|
| Output Voltage (Accuracy)<br>$V_{in} = 2.9\text{ V}$ to $5.9\text{ V}$ , $I_{load} = 0.1\text{ mA}$ to $500\text{ mA}$ , $T_A = 25^\circ\text{C}$   | $V_{out}$  | -0.9%<br>1.883 | 1.9                    | +0.9%<br>1.917                     | V   |
| Output Voltage (Accuracy)<br>$V_{in} = 2.9\text{ V}$ to $5.9\text{ V}$ , $I_{load} = 0.1\text{ mA}$ to $500\text{ mA}$ , $T_A = 0^\circ\text{C}$ to $+85^\circ\text{C}$   | $V_{out}$  | -1.4%<br>1.873 | 1.9                    | +1.4%<br>1.927                     | V   |
| Output Voltage (Accuracy), (Note 20)<br>$V_{in} = 2.9\text{ V}$ to $5.9\text{ V}$ , $I_{load} = 0.1\text{ mA}$ to $500\text{ mA}$ , $T_A = -40^\circ\text{C}$ to $+125^\circ\text{C}$   | $V_{out}$  | -1.5%<br>1.872 | 1.9                    | +1.5%<br>1.929                     | V   |
| Line Regulation<br>$V_{in} = 2.9\text{ V}$ to $12\text{ V}$ , $I_{load} = 0.1\text{ mA}$  | LineReg  |                | 0.04                   |                                    | mV/V  |
| Load Regulation<br>$V_{in} = 2.9\text{ V}$ , $I_{load} = 0.1\text{ mA}$ to $500\text{ mA}$  | LoadReg  |                | 0.04                   |                                    | mV/mA   |
| Dropout Voltage (See App Note)<br>$I_{load} = 500\text{ mA}$ (Notes 21, 22)<br>$I_{load} = 300\text{ mA}$ (Notes 21, 22)<br>$I_{load} = 50\text{ mA}$ (Notes 21, 22)  | $V_{DO}$   |                | 367<br>156<br>90       | 1030<br>1030<br>1030               | mV  |
| Peak Output Current (See Figure 16)   | $I_{pk}$   | 500            | 700                    | 800                                | mA  |
| Short Output Current (See Figure 16)  | $I_{sc}$   |                |                        | 900                                | mA  |
| Thermal Shutdown  | $T_J$  |                | 160                    |                                    | $^\circ\text{C}$                                |
| Ground Current<br>In Regulation<br>$I_{load} = 500\text{ mA}$ (Note 21)<br>$I_{load} = 300\text{ mA}$ (Note 21)<br>$I_{load} = 50\text{ mA}$<br>$I_{load} = 0.1\text{ mA}$<br><br>In Dropout<br>$V_{in} = 2.2\text{ V}$ , $I_{load} = 0.1\text{ mA}$<br><br>In Shutdown<br>$S_D = 0\text{ V}$ | $I_{GND}$<br><br><br><br><br><br><br><br>$I_{GNDsh}$ |                | 9.0<br>4.6<br>0.8<br>– | 14<br>7.5<br>2.5<br>190<br><br>500 | mA<br><br><br><br><br><br><br><br>$\mu\text{A}$ |
| Output Noise<br>$C_{nr} = 0\text{ nF}$ , $I_{load} = 500\text{ mA}$ , $f = 10\text{ Hz}$ to $100\text{ kHz}$ , $C_{out} = 10\text{ }\mu\text{F}$<br>$C_{nr} = 10\text{ nF}$ , $I_{load} = 500\text{ mA}$ , $f = 10\text{ Hz}$ to $100\text{ kHz}$ , $C_{out} = 10\text{ }\mu\text{F}$         | $V_{noise}$  |                | 53<br>33               |                                    | $\mu\text{Vrms}$<br>$\mu\text{Vrms}$            |
| Shutdown<br>Threshold Voltage ON<br>Threshold Voltage OFF   |  | 2.0            |                        | 0.4                                | V<br>V  |
| $S_D$ Input Current, $V_{SD} = 0\text{ V}$ to $0.4\text{ V}$ or $V_{SD} = 2.0\text{ V}$ to $V_{in}$   | $I_{SD}$   |                | 0.07                   | 1.0                                | $\mu\text{A}$                                   |
| Output Current In Shutdown Mode, $V_{out} = 0\text{ V}$   | $I_{OSD}$  |                | 0.07                   | 1.0                                | $\mu\text{A}$                                   |
| Reverse Bias Protection, Current Flowing from the Output Pin to GND<br>( $V_{in} = 0\text{ V}$ , $V_{out\_forced} = 1.9\text{ V}$ )   | $I_{OUTR}$   |                | 10                     |                                    | $\mu\text{A}$                                   |

19. Performance guaranteed over the operating temperature range by design and/or characterization, production tested at  $T_J = T_A = 25^\circ\text{C}$ . Low duty cycle pulse techniques are used during testing to maintain the junction temperature as close to ambient as possible.

20. For output current capability for  $T_A < 0^\circ\text{C}$ , please refer to Figure 21.

21.  $T_A$  must be greater than  $0^\circ\text{C}$ .

22. Maximum dropout voltage is limited by minimum input voltage  $V_{in} = 2.9\text{ V}$  recommended for guaranteed operation.

# NCV8535

## ELECTRICAL CHARACTERISTICS – 1.8 V

( $V_{out} = 1.8\text{ V}$  typical,  $V_{in} = 2.9\text{ V}$ ,  $T_A = -40^\circ\text{C}$  to  $+85^\circ\text{C}$ , unless otherwise noted, Note 23.)

| Characteristic  | Symbol   | Min            | Typ                    | Max                                | Unit  |
|---|--|----------------|------------------------|------------------------------------|---|
| Output Voltage (Accuracy)<br>$V_{in} = 2.9\text{ V}$ to $5.8\text{ V}$ , $I_{load} = 0.1\text{ mA}$ to $500\text{ mA}$ , $T_A = 25^\circ\text{C}$   | $V_{out}$  | -0.9%<br>1.783 | 1.8                    | +0.9%<br>1.817                     | V   |
| Output Voltage (Accuracy)<br>$V_{in} = 2.9\text{ V}$ to $5.8\text{ V}$ , $I_{load} = 0.1\text{ mA}$ to $500\text{ mA}$ , $T_A = 0^\circ\text{C}$ to $+85^\circ\text{C}$   | $V_{out}$  | -1.4%<br>1.774 | 1.8                    | +1.4%<br>1.826                     | V   |
| Output Voltage (Accuracy), (Note 24)<br>$V_{in} = 2.9\text{ V}$ to $5.8\text{ V}$ , $I_{load} = 0.1\text{ mA}$ to $500\text{ mA}$ , $T_A = -40^\circ\text{C}$ to $+125^\circ\text{C}$   | $V_{out}$  | -1.5%<br>1.773 | 1.8                    | +1.5%<br>1.827                     | V   |
| Line Regulation<br>$V_{in} = 2.9\text{ V}$ to $12\text{ V}$ , $I_{load} = 0.1\text{ mA}$  | LineReg  |                | 0.04                   |                                    | mV/V  |
| Load Regulation<br>$V_{in} = 2.9\text{ V}$ , $I_{load} = 0.1\text{ mA}$ to $500\text{ mA}$  | LoadReg  |                | 0.04                   |                                    | mV/mA   |
| Dropout Voltage (See App Note)<br>$I_{load} = 500\text{ mA}$ (Notes 25, 26)<br>$I_{load} = 300\text{ mA}$ (Notes 25, 26)<br>$I_{load} = 50\text{ mA}$ (Notes 25, 26)  | $V_{DO}$   |                | 620<br>230<br>95       | 1130<br>1130<br>1130               | mV  |
| Peak Output Current (See Figure 16)   | $I_{pk}$   | 500            | 700                    | 830                                | mA  |
| Short Output Current (See Figure 16)  | $I_{sc}$   |                |                        | 900                                | mA  |
| Thermal Shutdown  | $T_J$  |                | 160                    |                                    | $^\circ\text{C}$                                |
| Ground Current<br>In Regulation<br>$I_{load} = 500\text{ mA}$ (Note 25)<br>$I_{load} = 300\text{ mA}$ (Note 25)<br>$I_{load} = 50\text{ mA}$<br>$I_{load} = 0.1\text{ mA}$<br><br>In Dropout<br>$V_{in} = 2.2\text{ V}$ , $I_{load} = 0.1\text{ mA}$<br><br>In Shutdown<br>$S_D = 0\text{ V}$ | $I_{GND}$<br><br><br><br><br><br><br><br>$I_{GNDsh}$ |                | 9.0<br>4.6<br>0.8<br>– | 14<br>7.5<br>2.5<br>190<br><br>500 | mA<br><br><br><br><br><br><br><br>$\mu\text{A}$ |
| Output Noise<br>$C_{nr} = 0\text{ nF}$ , $I_{load} = 500\text{ mA}$ , $f = 10\text{ Hz}$ to $100\text{ kHz}$ , $C_{out} = 10\text{ }\mu\text{F}$<br>$C_{nr} = 10\text{ nF}$ , $I_{load} = 500\text{ mA}$ , $f = 10\text{ Hz}$ to $100\text{ kHz}$ , $C_{out} = 10\text{ }\mu\text{F}$         | $V_{noise}$  |                | 52<br>33               |                                    | $\mu\text{Vrms}$<br>$\mu\text{Vrms}$            |
| Shutdown<br>Threshold Voltage ON<br>Threshold Voltage OFF   |  | 2.0            |                        | 0.4                                | V<br>V  |
| $S_D$ Input Current, $V_{SD} = 0\text{ V}$ to $0.4\text{ V}$ or $V_{SD} = 2.0\text{ V}$ to $V_{in}$   | $I_{SD}$   |                | 0.07                   | 1.0                                | $\mu\text{A}$                                   |
| Output Current In Shutdown Mode, $V_{out} = 0\text{ V}$   | $I_{OSD}$  |                | 0.07                   | 1.0                                | $\mu\text{A}$                                   |
| Reverse Bias Protection, Current Flowing from the Output Pin to GND<br>( $V_{in} = 0\text{ V}$ , $V_{out\_forced} = 1.8\text{ V}$ )   | $I_{OUTR}$   |                | 10                     |                                    | $\mu\text{A}$                                   |

23. Performance guaranteed over the operating temperature range by design and/or characterization, production tested at  $T_J = T_A = 25^\circ\text{C}$ . Low duty cycle pulse techniques are used during testing to maintain the junction temperature as close to ambient as possible.

24. For output current capability for  $T_A < 0^\circ\text{C}$ , please refer to Figure 21.

25.  $T_A$  must be greater than  $0^\circ\text{C}$ .

26. Maximum dropout voltage is limited by minimum input voltage  $V_{in} = 2.9\text{ V}$  recommended for guaranteed operation.

**ELECTRICAL CHARACTERISTICS – 1.5 V**

( $V_{out} = 1.5\text{ V}$  typical,  $V_{in} = 2.9\text{ V}$ ,  $T_A = -40^\circ\text{C}$  to  $+85^\circ\text{C}$ , unless otherwise noted, Note 27.)

| Characteristic  | Symbol   | Min            | Typ                    | Max                                | Unit  |
|---|--|----------------|------------------------|------------------------------------|---|
| Output Voltage (Accuracy)<br>$V_{in} = 2.9\text{ V}$ to $5.5\text{ V}$ , $I_{load} = 0.1\text{ mA}$ to $500\text{ mA}$ , $T_A = 25^\circ\text{C}$   | $V_{out}$  | -0.9%<br>1.486 | 1.5                    | +0.9%<br>1.514                     | V   |
| Output Voltage (Accuracy)<br>$V_{in} = 2.9\text{ V}$ to $5.5\text{ V}$ , $I_{load} = 0.1\text{ mA}$ to $500\text{ mA}$ , $T_A = 0^\circ\text{C}$ to $+85^\circ\text{C}$   | $V_{out}$  | -1.4%<br>1.479 | 1.5                    | +1.4%<br>1.521                     | V   |
| Output Voltage (Accuracy), (Note 28)<br>$V_{in} = 2.9\text{ V}$ to $5.5\text{ V}$ , $I_{load} = 0.1\text{ mA}$ to $500\text{ mA}$ , $T_A = -40^\circ\text{C}$ to $+125^\circ\text{C}$   | $V_{out}$  | -1.5%<br>1.477 | 1.5                    | +1.5%<br>1.523                     | V   |
| Line Regulation<br>$V_{in} = 2.9\text{ V}$ to $12\text{ V}$ , $I_{load} = 0.1\text{ mA}$  | LineReg  |                | 0.04                   |                                    | mV/V  |
| Load Regulation<br>$V_{in} = 2.9\text{ V}$ , $I_{load} = 0.1\text{ mA}$ to $500\text{ mA}$  | LoadReg  |                | 0.04                   |                                    | mV/mA   |
| Dropout Voltage (See App Note)<br>$I_{load} = 500\text{ mA}$ (Notes 29, 30)<br>$I_{load} = 300\text{ mA}$ (Notes 29, 30)<br>$I_{load} = 50\text{ mA}$ (Notes 29, 30)  | $V_{DO}$   |                | 940<br>500<br>350      | 1430<br>1430<br>1430               | mV  |
| Peak Output Current (See Figure 16)   | $I_{pk}$   | 500            | 700                    | 860                                | mA  |
| Short Output Current (See Figure 16)  | $I_{sc}$   |                |                        | 900                                | mA  |
| Thermal Shutdown  | $T_J$  |                | 160                    |                                    | $^\circ\text{C}$                                |
| Ground Current<br>In Regulation<br>$I_{load} = 500\text{ mA}$ (Note 29)<br>$I_{load} = 300\text{ mA}$ (Note 29)<br>$I_{load} = 50\text{ mA}$<br>$I_{load} = 0.1\text{ mA}$<br><br>In Dropout<br>$V_{in} = 2.2\text{ V}$ , $I_{load} = 0.1\text{ mA}$<br><br>In Shutdown<br>$S_D = 0\text{ V}$ | $I_{GND}$<br><br><br><br><br><br><br><br>$I_{GNDsh}$ |                | 9.0<br>4.6<br>0.8<br>– | 14<br>7.5<br>2.5<br>190<br><br>500 | mA<br><br><br><br><br><br><br><br>$\mu\text{A}$ |
| Output Noise<br>$C_{nr} = 0\text{ nF}$ , $I_{load} = 500\text{ mA}$ , $f = 10\text{ Hz}$ to $100\text{ kHz}$ , $C_{out} = 10\text{ }\mu\text{F}$<br>$C_{nr} = 10\text{ nF}$ , $I_{load} = 500\text{ mA}$ , $f = 10\text{ Hz}$ to $100\text{ kHz}$ , $C_{out} = 10\text{ }\mu\text{F}$         | $V_{noise}$  |                | 51<br>31               |                                    | $\mu\text{Vrms}$<br>$\mu\text{Vrms}$            |
| Shutdown<br>Threshold Voltage ON<br>Threshold Voltage OFF   |  | 2.0            |                        | 0.4                                | V<br>V  |
| $S_D$ Input Current, $V_{SD} = 0\text{ V}$ to $0.4\text{ V}$ or $V_{SD} = 2.0\text{ V}$ to $V_{in}$   | $I_{SD}$   |                | 0.07                   | 1.0                                | $\mu\text{A}$                                   |
| Output Current In Shutdown Mode, $V_{out} = 0\text{ V}$   | $I_{OSD}$  |                | 0.07                   | 1.0                                | $\mu\text{A}$                                   |
| Reverse Bias Protection, Current Flowing from the Output Pin to GND<br>( $V_{in} = 0\text{ V}$ , $V_{out\_forced} = 1.5\text{ V}$ )   | $I_{OUTR}$   |                | 10                     |                                    | $\mu\text{A}$                                   |

27. Performance guaranteed over the operating temperature range by design and/or characterization, production tested at  $T_J = T_A = 25^\circ\text{C}$ . Low duty cycle pulse techniques are used during testing to maintain the junction temperature as close to ambient as possible.

28. For output current capability for  $T_A < 0^\circ\text{C}$ , please refer to Figure 22.

29.  $T_A$  must be greater than  $0^\circ\text{C}$ .

30. Maximum dropout voltage is limited by minimum input voltage  $V_{in} = 2.9\text{ V}$  recommended for guaranteed operation.

**ELECTRICAL CHARACTERISTICS – Adjustable**

( $V_{out} = 1.25$  V typical,  $V_{in} = 2.9$  V,  $T_A = -40^{\circ}\text{C}$  to  $+85^{\circ}\text{C}$ , unless otherwise noted, Note 31)

| Characteristic   | Symbol   | Min            | Typ                                 | Max                                   | Unit  |
|--|--|----------------|-------------------------------------|---------------------------------------|---|
| Reference Voltage (Accuracy)<br>$V_{in} = 2.9$ V to $V_{out} + 4.0$ V, $I_{load} = 0.1$ mA to 500 mA, $T_A = 25^{\circ}\text{C}$   | $V_{ref}$  | -0.9%<br>1.239 | 1.25                                | +0.9%<br>1.261                        | V   |
| Reference Voltage (Accuracy)<br>$V_{in} = 2.9$ V to $V_{out} + 4.0$ V, $I_{load} = 0.1$ mA to 500 mA, $T_A = 0^{\circ}\text{C}$ to $+85^{\circ}\text{C}$   | $V_{ref}$  | -1.4%<br>1.233 | 1.25                                | +1.4%<br>1.268                        | V   |
| Reference Voltage (Accuracy) (Note 32)<br>$V_{in} = 2.9$ V to $V_{out} + 4.0$ V, $I_{load} = 0.1$ mA to 500 mA, $T_A = -40^{\circ}\text{C}$ to $+125^{\circ}\text{C}$  | $V_{ref}$  | -1.5%<br>1.231 | 1.25                                | +1.5%<br>1.269                        | V   |
| Line Regulation<br>$V_{in} = 2.9$ V to 12 V, $I_{load} = 0.1$ mA   | LineReg  |                | 0.04                                |                                       | mV/V  |
| Load Regulation<br>$V_{in} = 2.9$ V, $I_{load} = 0.1$ mA to 500 mA   | LoadReg  |                | 0.04                                |                                       | mV/mA   |
| Dropout Voltage (See App Note), $V_{out} = 2.5$ V to 10 V<br>$I_{load} = 500$ mA (Note 33)<br>$I_{load} = 300$ mA<br>$I_{load} = 50$ mA<br>$I_{load} = 0.1$ mA   | $V_{DO}$   |                |                                     | 340<br>230<br>110<br>10               | mV  |
| Peak Output Current (Note 33) (See Figure 16)  | $I_{pk}$   | 500            | 700                                 | 860                                   | mA  |
| Short Output Current (See Figure 16)<br>$V_{out} \leq 3.3$ V<br>$V_{out} > 3.3$ V  | $I_{sc}$   |                |                                     | 900<br>990                            | mA  |
| Thermal Shutdown   | $T_J$  |                | 160                                 |                                       | $^{\circ}\text{C}$                              |
| Ground Current<br>In Regulation<br>$I_{load} = 500$ mA (Note 33)<br>$I_{load} = 300$ mA (Note 33)<br>$I_{load} = 50$ mA<br>$I_{load} = 0.1$ mA<br><br>In Dropout<br>$V_{in} = V_{out} - 0.1$ V or 2.2 V (whichever is higher), $I_{load} = 0.1$ mA<br><br>In Shutdown<br>$S_D = 0$ V | $I_{GND}$<br><br><br><br><br><br><br><br>$I_{GNDsh}$ |                | 9.0<br>4.6<br>0.8<br>–<br>–<br>0.07 | 14<br>7.5<br>2.5<br>190<br>500<br>1.0 | mA<br><br><br><br><br><br><br><br>$\mu\text{A}$ |
| Output Noise<br>$C_{nr} = 0$ nF, $I_{load} = 500$ mA, $f = 10$ Hz to 100 kHz, $C_{out} = 10$ $\mu\text{F}$<br>$C_{nr} = 10$ nF, $I_{load} = 500$ mA, $f = 10$ Hz to 100 kHz, $C_{out} = 10$ $\mu\text{F}$  | $V_{noise}$  |                | 38<br>26                            |                                       | $\mu\text{V}_{rms}$<br>$\mu\text{V}_{rms}$      |
| Shutdown<br>Threshold Voltage ON<br>Threshold Voltage OFF  |  | 2.0            |                                     | 0.4                                   | V<br>V  |
| $S_D$ Input Current, $V_{SD} = 0$ V to 0.4 V or $V_{SD} = 2.0$ V to $V_{in}$<br>$V_{in} \leq 5.4$ V<br>$V_{in} > 5.4$ V  | $I_{SD}$   |                | 0.07                                | 1.0<br>5.0                            | $\mu\text{A}$                                   |
| Output Current In Shutdown Mode, $V_{out} = 0$ V   | $I_{OSD}$  |                | 0.07                                | 1.0                                   | $\mu\text{A}$                                   |
| Reverse Bias Protection, Current Flowing from the Output Pin to GND<br>( $V_{in} = 0$ V, $V_{out\_forced} = V_{out}(\text{nom}) \leq 7$ V) (Note 34)   | $I_{OUTR}$   |                | 1.0                                 |                                       | $\mu\text{A}$                                   |

31. Performance guaranteed over the operating temperature range by design and/or characterization, production tested at  $T_J = T_A = 25^{\circ}\text{C}$ . Low duty cycle pulse techniques are used during testing to maintain the junction temperature as close to ambient as possible.

32. For output current capability for  $T_A < 0^{\circ}\text{C}$ , please refer to Figures 18 to 22.

33.  $T_A$  must be greater than  $0^{\circ}\text{C}$ .

34. Reverse bias protection feature valid only if  $V_{out} - V_{in} \leq 7$  V.

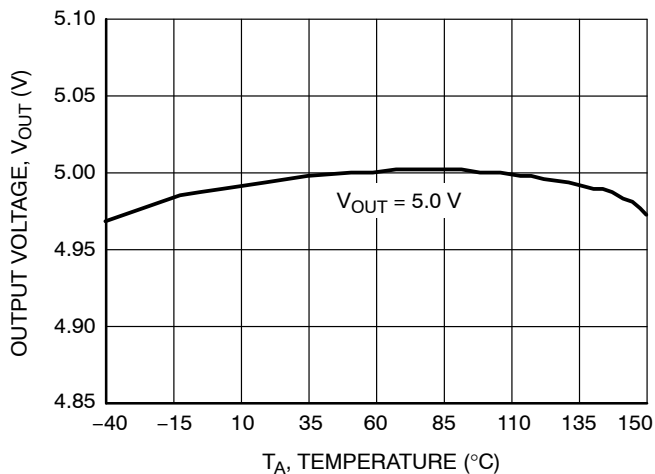

Figure 5. Output Voltage vs. Temperature  
5.0 V Version

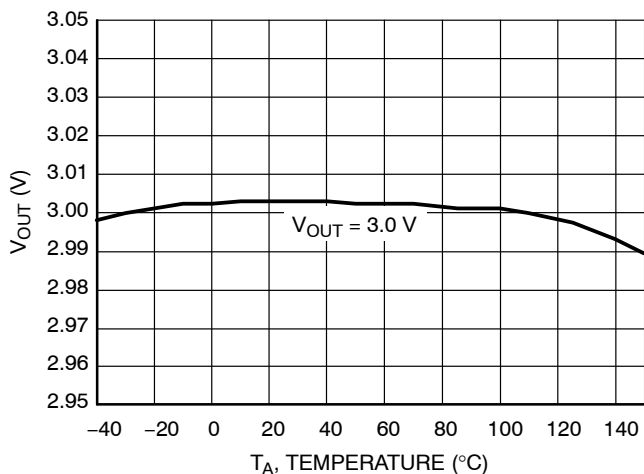

Figure 6. Output Voltage vs. Temperature  
3.0 V Version

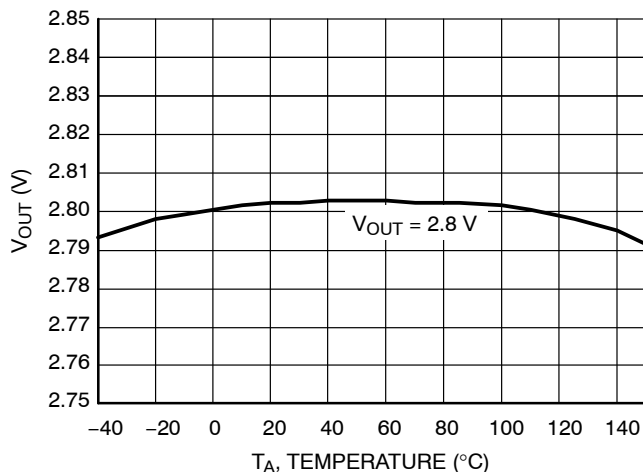

Figure 7. Output Voltage vs. Temperature  
2.8 V Version

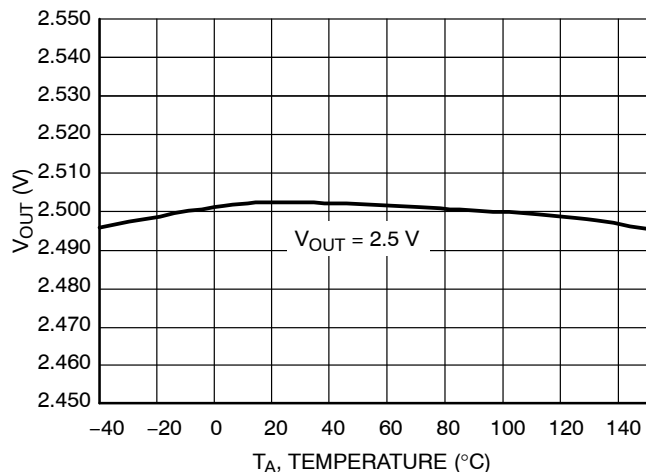

Figure 8. Output Voltage vs. Temperature  
2.5 V Version

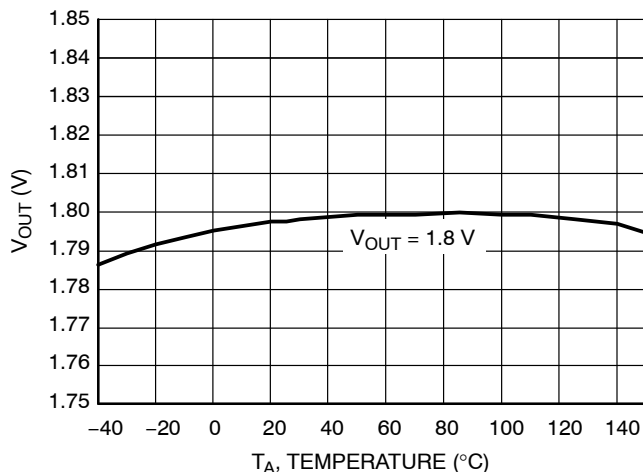

Figure 9. Output Voltage vs. Temperature  
1.8 V Version

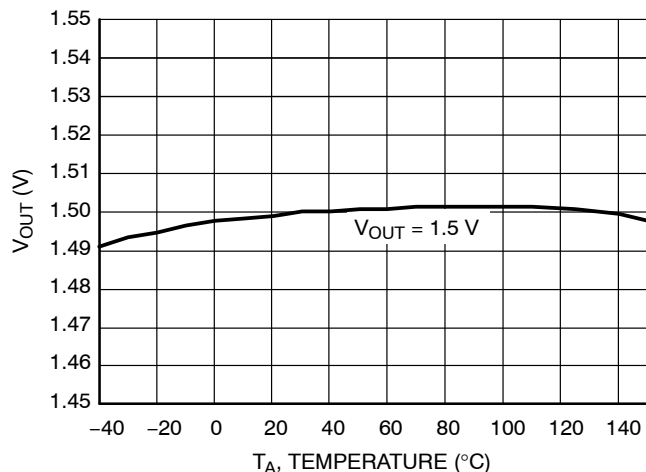
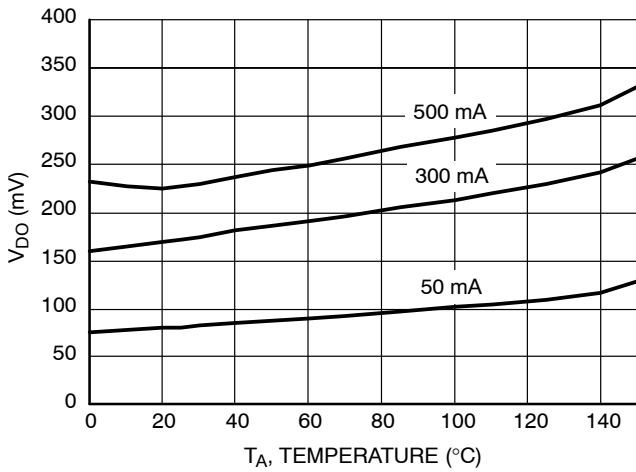

Figure 10. Output Voltage vs. Temperature  
1.5 V Version



# NCV8535



**Figure 11. Dropout Voltage vs. Temperature  
2.8 V Version**

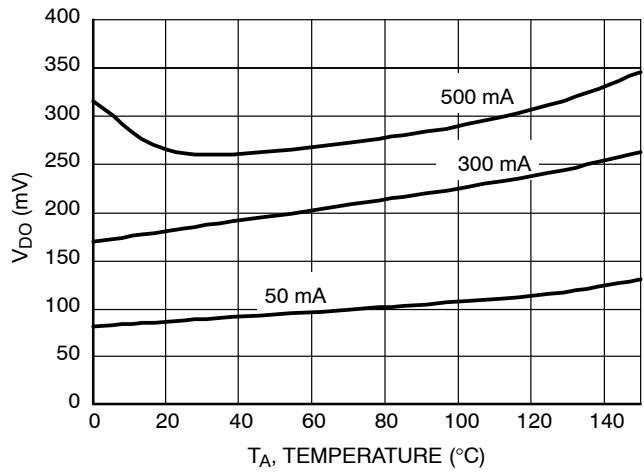

**Figure 12. Dropout Voltage vs. Temperature  
2.5 V Version**

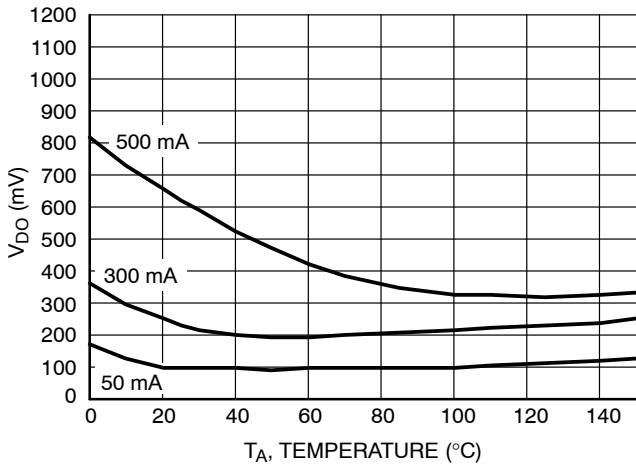

**Figure 13. Dropout Voltage vs. Temperature  
1.8 V Version**

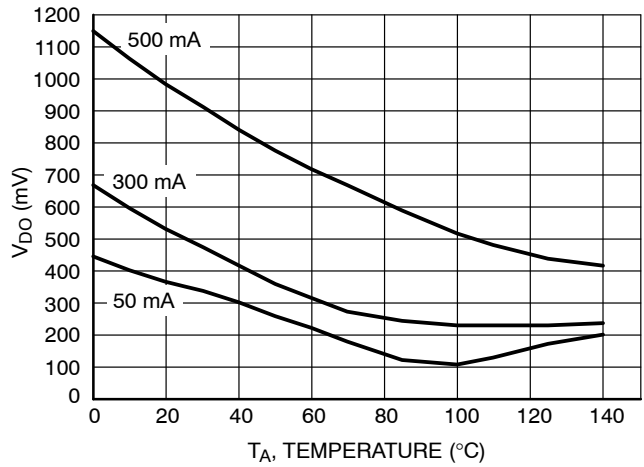

**Figure 14. Dropout Voltage vs. Temperature  
1.5 V Version**

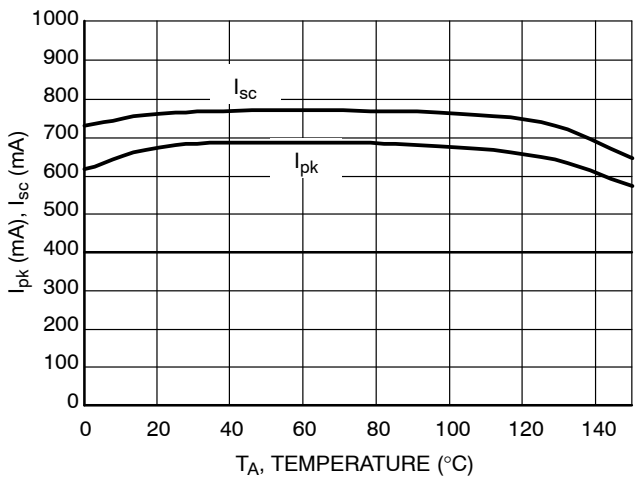

**Figure 15. Peak and Short Current  
vs. Temperature**

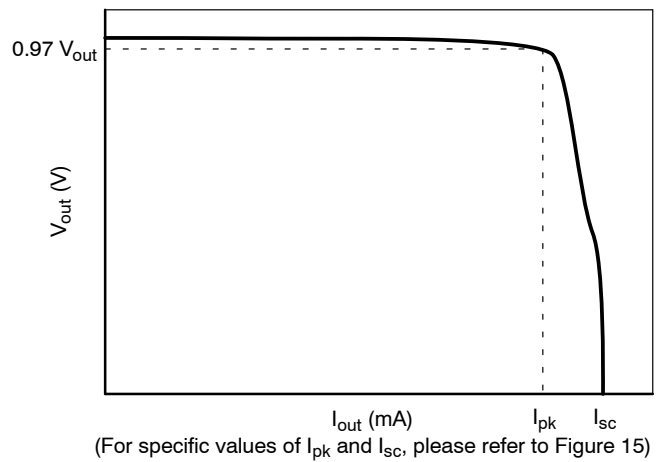

**Figure 16. Output Voltage vs. Output Current**

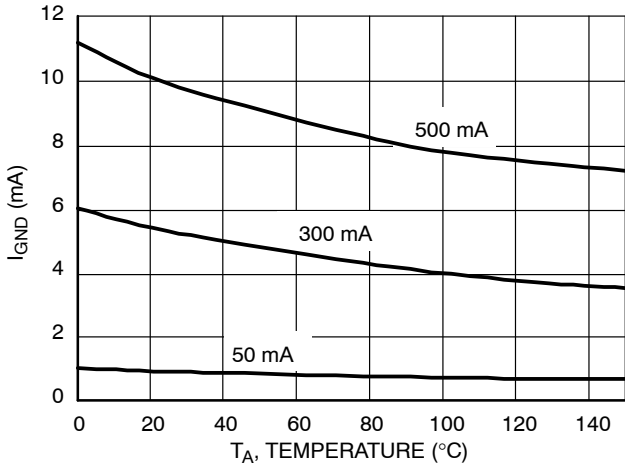

Figure 17. Ground Current vs. Temperature

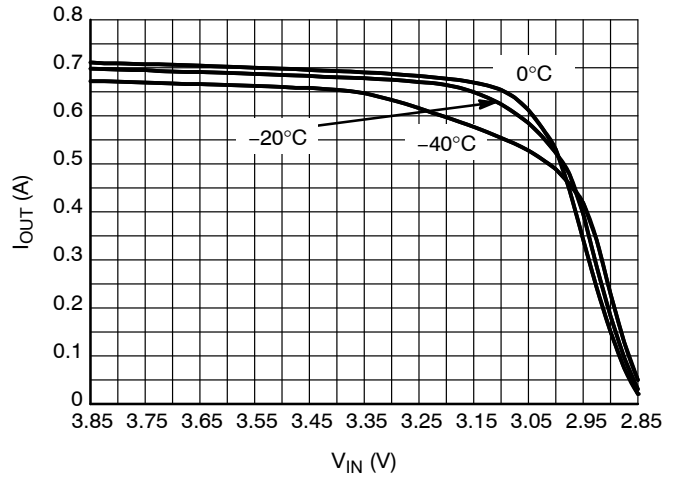

Figure 18. Output Current Capability for the 2.85 V Version

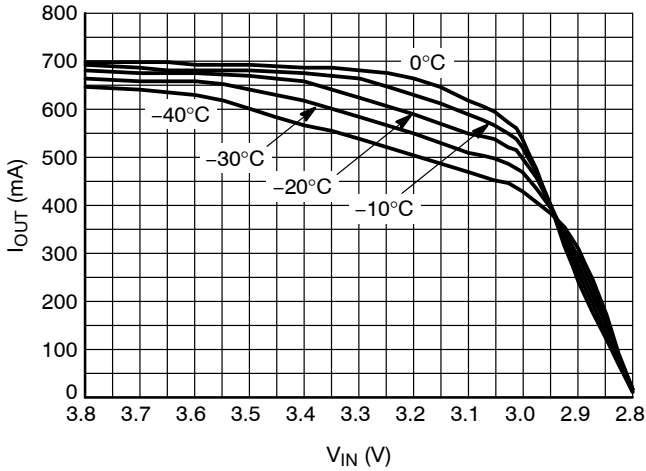

Figure 19. Output Current Capability for the 2.8 V Version

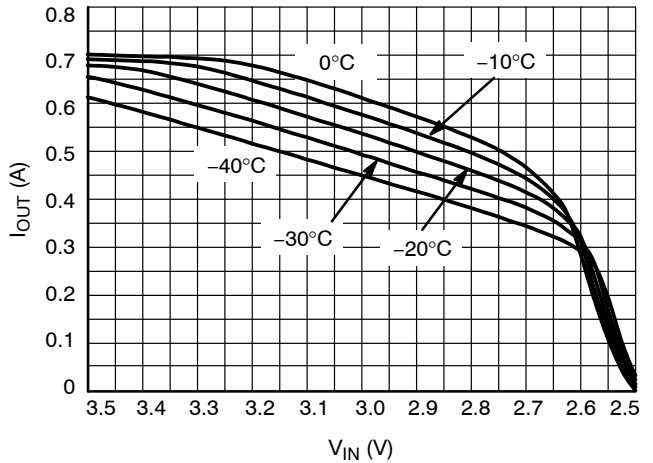

Figure 20. Output Current Capability for the 2.5 V Version

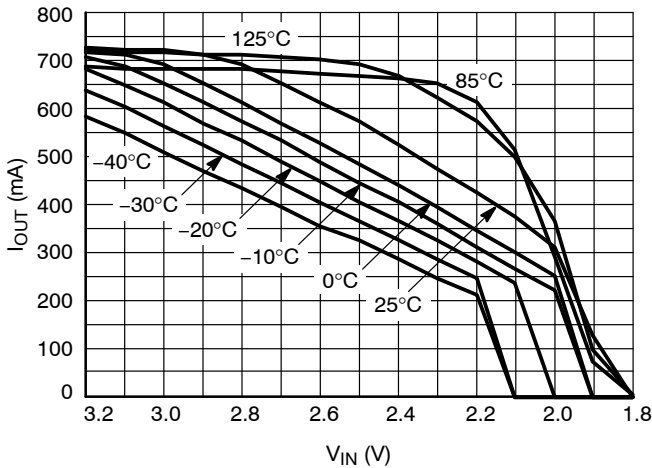

Figure 21. Output Current Capability for the 1.8 V Version

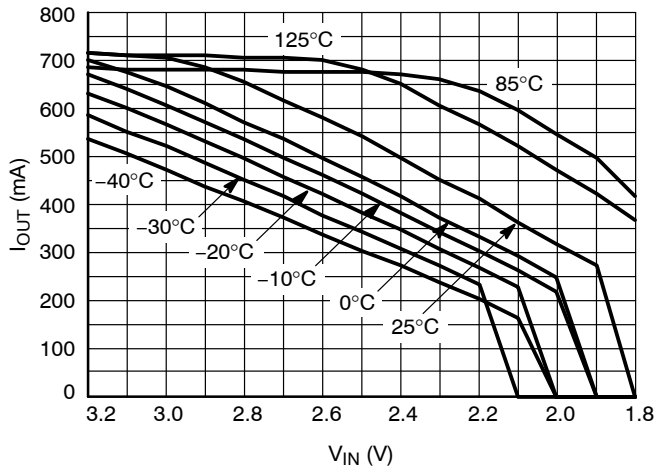

Figure 22. Output Current Capability for the 1.5 V Version

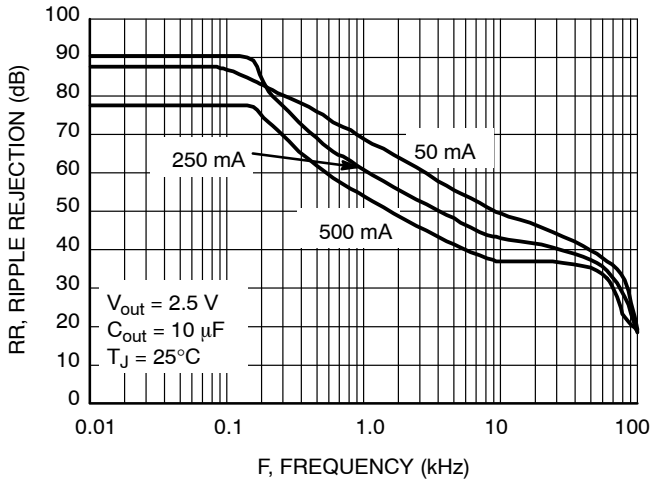

Figure 23. Ripple Rejection vs. Frequency

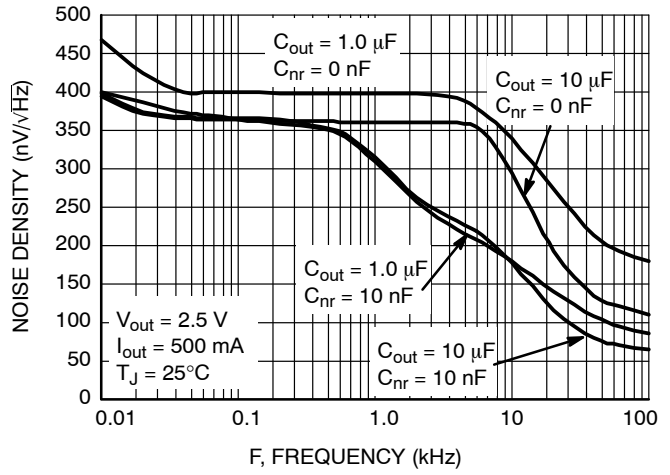

Figure 24. Output Noise Density

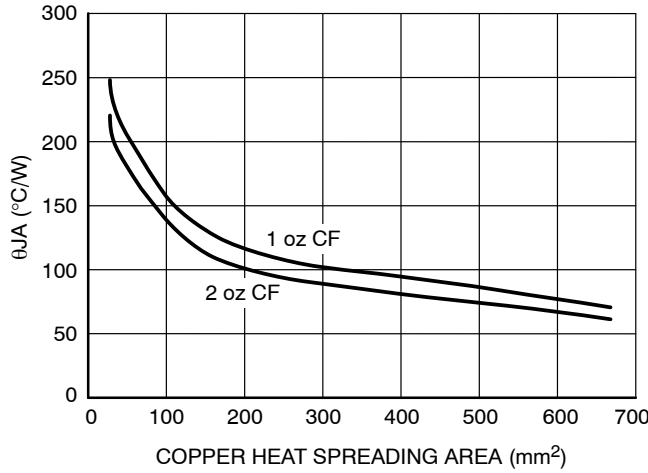

Figure 25. DFN 10 Self Heating Thermal Characteristic as a Function of Copper Area on the PCB

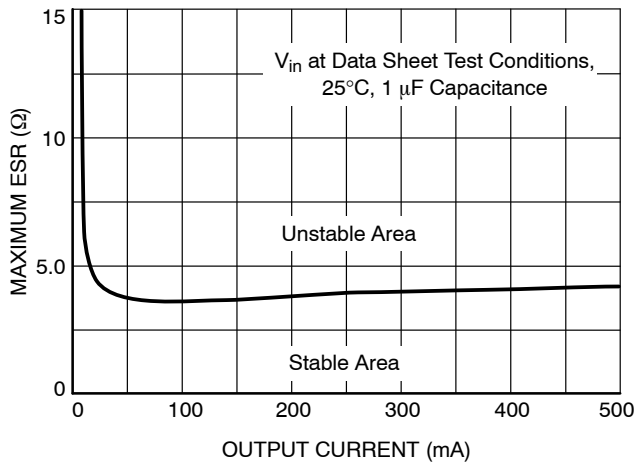

Figure 26. Stability with ESR vs.  $I_{out}$

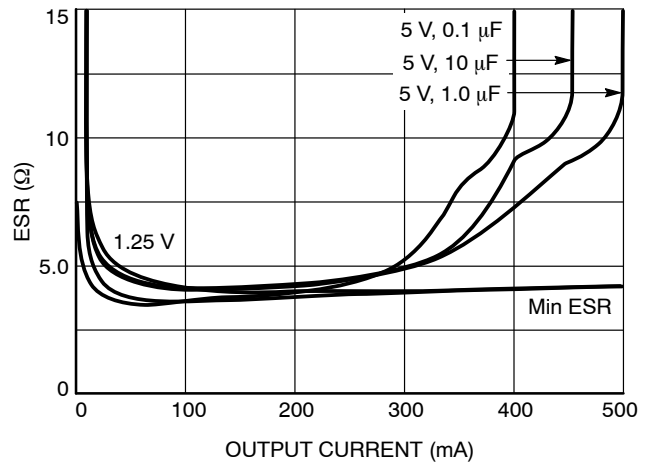

Figure 27. Output Current vs. ESR

NOTE: Typical characteristics were measured with the same conditions as electrical characteristics.

APPLICATIONS INFORMATION

**Reverse Bias Protection**

Reverse bias is a condition caused when the input voltage goes to zero, but the output voltage is kept high either by a large output capacitor or another source in the application which feeds the output pin.

Normally in a bipolar LDO all the current will flow from the output pin to input pin through the PN junction with limited current capability and with the potential to destroy the IC.

Due to an improved architecture, the NCV8535 can withstand up to 7.0 V on the output pin with virtually no current flowing from output pin to input pin, and only negligible amount of current (tens of  $\mu\text{A}$ ) flowing from the output pin to ground for infinite duration.

**Input Capacitor**

An input capacitor of at least 1.0  $\mu\text{F}$ , any type, is recommended to improve the transient response of the regulator and/or if the regulator is located more than a few inches from the power source. It will also reduce the circuit's sensitivity to the input line impedance at high frequencies. The capacitor should be mounted with the shortest possible track length directly across the regular's input terminals.

**Output Capacitor**

The NCV8535 remains stable with any type of capacitor as long as it fulfills its 1.0  $\mu\text{F}$  requirement. There are no constraints on the minimum ESR and it will remain stable up to an ESR of 5.0  $\Omega$ . Larger capacitor values will improve the noise rejection and load transient response.

**Noise Reduction Pin**

Output noise can be greatly reduced by connecting a 10 nF capacitor ( $C_{nr}$ ) between the noise reduction pin and ground (see Figure 1). In applications where very low noise is not required, the noise reduction pin can be left unconnected.

For the adjustable version, in addition to the 10 nF  $C_{nr}$ , a 68 pF capacitor connected in parallel with R1 (see Figure 2) is recommended to further reduce output noise and improve stability.

**Adjustable Operation**

The output voltage can be set by using a resistor divider as shown in Figure 2 with a range of 1.25 to 10 V. The appropriate resistor divider can be found by solving the equation below. The recommended current through the resistor divider is from 10  $\mu\text{A}$  to 100  $\mu\text{A}$ . This can be accomplished by selecting resistors in the  $\text{k}\Omega$  range. As result, the  $I_{adj} * R2$  becomes negligible in the equation and can be ignored.

$$V_{out} = 1.25 * \left(1 + \frac{R1}{R2}\right) + I_{adj} * R2 \quad (\text{eq. 1})$$

Example:

For  $V_{out} = 2.9 \text{ V}$ , can use  $R1 = 36 \text{ k}\Omega$  and  $R2 = 27 \text{ k}\Omega$ .

$$1.25 * \left(1 + \frac{36 \text{ k}\Omega}{27 \text{ k}\Omega}\right) = 2.91 \text{ V} \quad (\text{eq. 2})$$

**Dropout Voltage**

The voltage dropout is measured at 97% of the nominal output voltage.

**No-Load Regulation Considerations**

If there is no load at output of the regulator and ambient temperature is higher than 85°C leakage current flowing from input to output through pass transistor may cause increase of output voltage out of specification range up to input voltage level. To avoid this situation minimum load current of 100  $\mu\text{A}$  or higher is recommended if ambient temperature exceeds 85°C.

**Thermal Considerations**

Internal thermal limiting circuitry is provided to protect the integrated circuit in the event that the maximum junction temperature is exceeded. This feature provides protection from a catastrophic device failure due to accidental overheating. This protection feature is not intended to be used as a substitute to heat sinking. The maximum power that can be dissipated, can be calculated with the equation below:

$$P_D = \frac{T_{J(max)} - T_A}{R_{\theta JA}} \quad (\text{eq. 3})$$

# NCV8535

## DEVICE ORDERING INFORMATION

| Device*         | Voltage Option | Marking Code | Package            | Feature                       | Shipping†          |
|-----------------|----------------|--------------|--------------------|-------------------------------|--------------------|
| NCV8535MNADJR2G | Adj.           | V8535 ADJ    | DFN10<br>(Pb-Free) | Non-Wettable<br>Flank         | 3000 / Tape & Reel |
| NCV8535MN150R2G | 1.5 V          | V8535 150    |                    |                               |                    |
| NCV8535MN180R2G | 1.8 V          | V8535 180    |                    |                               |                    |
| NCV8535MN190R2G | 1.9 V          | V8535 190    |                    |                               |                    |
| NCV8535MN250R2G | 2.5 V          | V8535 250    |                    |                               |                    |
| NCV8535MN280R2G | 2.8 V          | V8535 280    |                    |                               |                    |
| NCV8535MN285R2G | 2.85 V         | V8535 285    |                    |                               |                    |
| NCV8535MN300R2G | 3.0 V          | V8535 300    |                    |                               |                    |
| NCV8535MN330R2G | 3.3 V          | V8535 330    |                    |                               |                    |
| NCV8535MN350R2G | 3.5 V          | V8535 350    |                    |                               |                    |
| NCV8535MN500R2G | 5.0 V          | V8535 500    |                    |                               |                    |
| NCV8535MLADJR2G | Adj.           | L8535 ADJ    | DFN10<br>(Pb-Free) | Wettable Flank<br>SLP Process | 3000 / Tape & Reel |
| NCV8535ML180R2G | 1.8 V          | L8535 180    |                    |                               |                    |
| NCV8535ML250R2G | 2.5 V          | L8535 250    |                    |                               |                    |
| NCV8535ML330R2G | 3.3 V          | L8535 330    |                    |                               |                    |

†For information on tape and reel specifications, including part orientation and tape sizes, please refer to our Tape and Reel Packaging Specifications Brochure, BRD8011/D.

\*NCV Prefix for Automotive and Other Applications Requiring Unique Site and Control Change Requirements; AEC-Q100 Qualified and PPAP Capable.

# MECHANICAL CASE OUTLINE PACKAGE DIMENSIONS



SCALE 2:1

## DFN10, 3x3, 0.5P CASE 485C ISSUE F

DATE 16 DEC 2021

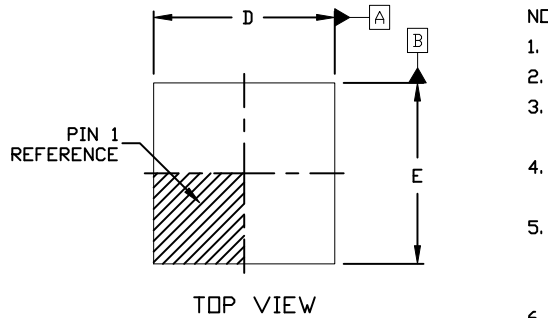

### NOTES:

1. DIMENSION AND TOLERANCING PER ASME Y14.5, 2009.
2. CONTROLLING DIMENSION: MILLIMETERS
3. DIMENSION *b* APPLIES TO PLATED TERMINAL AND IS MEASURED BETWEEN 0.15 AND 0.30 MM FROM THE TERMINAL TIP.
4. COPLANARITY APPLIES TO THE EXPOSED PAD AS WELL AS THE TERMINALS.
5. TERMINAL *b* MAY HAVE MOLD COMPOUND MATERIAL ALONG SIDE EDGE. MOLD FLASH MAY NOT EXCEED 30 MICRONS ONTO BOTTOM SURFACE OF TERMINAL.
6. FOR DEVICE OPN CONTAINING W OPTION, DETAIL A AND DETAIL B ALTERNATE CONSTRUCTIONS ARE NOT APPLICABLE. WETTABLE FLANK CONSTRUCTION IS DETAIL B AS SHOWN ON SIDE VIEW OF PACKAGE.

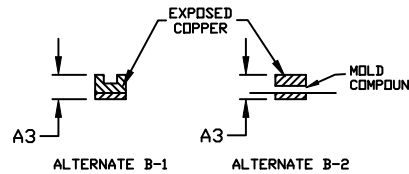
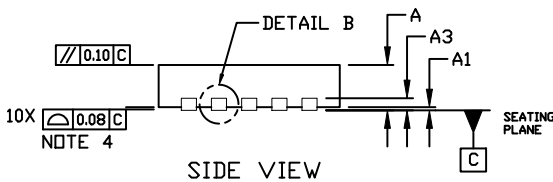

| DIM      | MILLIMETERS |      |      |
|----------|-------------|------|------|
|          | MIN.        | NOM. | MAX. |
| A        | 0.80        | 0.90 | 1.00 |
| A1       | 0.00        | ---  | 0.05 |
| A3       | 0.20 REF    |      |      |
| <i>b</i> | 0.18        | 0.23 | 0.30 |
| D        | 2.90        | 3.00 | 3.10 |
| D2       | 2.40        | 2.50 | 2.60 |
| E        | 2.90        | 3.00 | 3.10 |
| E2       | 1.70        | 1.80 | 1.90 |
| <i>e</i> | 0.50 BSC    |      |      |
| K        | 0.20 REF    |      |      |
| L        | 0.30        | 0.40 | 0.50 |
| L1       | ---         | ---  | 0.03 |

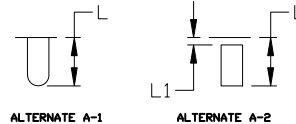
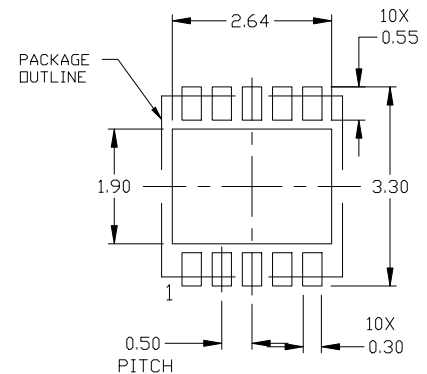
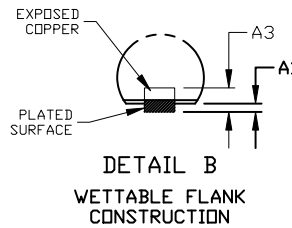
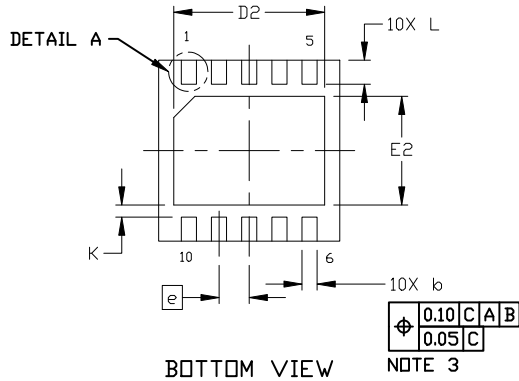

### GENERIC MARKING DIAGRAM\*



- XXXXX = Specific Device Code
- A = Assembly Location
- L = Wafer Lot
- Y = Year
- W = Work Week
- = Pb-Free Package

(Note: Microdot may be in either location)

\*This information is generic. Please refer to device data sheet for actual part marking. Pb-Free indicator, "G" or microdot "▪", may or may not be present. Some products may not follow the Generic Marking.

### RECOMMENDED MOUNTING FOOTPRINT

For additional information on our Pb-Free strategy and soldering details, please download the ON Semiconductor Soldering and Mounting Techniques Reference Manual, SOLDERRM/D.

|                         |                                    |  |
|-------------------------|------------------------------------|--|
| <b>DOCUMENT NUMBER:</b> | <b>98AON03161D</b>                 | Electronic versions are uncontrolled except when accessed directly from the Document Repository. Printed versions are uncontrolled except when stamped "CONTROLLED COPY" in red. |
| <b>DESCRIPTION:</b>     | <b>DFN10, 3X3 MM, 0.5 MM PITCH</b> | <b>PAGE 1 OF 1</b>   |

onsemi and ONSEMI are trademarks of Semiconductor Components Industries, LLC dba onsemi or its subsidiaries in the United States and/or other countries. onsemi reserves the right to make changes without further notice to any products herein. onsemi makes no warranty, representation or guarantee regarding the suitability of its products for any particular purpose, nor does onsemi assume any liability arising out of the application or use of any product or circuit, and specifically disclaims any and all liability, including without limitation special, consequential or incidental damages. onsemi does not convey any license under its patent rights nor the rights of others.

# MECHANICAL CASE OUTLINE

## PACKAGE DIMENSIONS

ON Semiconductor®



### DFNW10 3x3, 0.5P CASE 507AM ISSUE A

DATE 12 JUN 2018

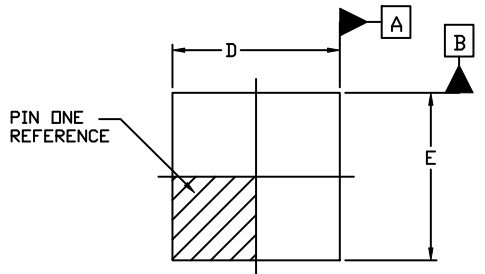

TOP VIEW

NOTES:

1. DIMENSIONING AND TOLERANCING PER ASME Y14.5M, 1994.
2. CONTROLLING DIMENSION: MILLIMETERS
3. DIMENSION b APPLIES TO PLATED TERMINAL AND IS MEASURED BETWEEN 0.25 AND 0.30 MM FROM THE TERMINAL TIP.
4. COPLANARITY APPLIES TO THE EXPOSED PAD AS WELL AS THE TERMINALS.

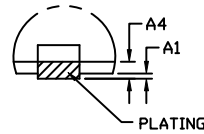

DETAIL B

| DIM | MILLIMETERS |      |      |
|-----|-------------|------|------|
|     | MIN.        | NOM. | MAX. |
| A   | 0.80        | 0.90 | 1.00 |
| A1  | 0.00        | ---  | 0.05 |
| A3  | 0.20 REF    |      |      |
| A4  | 0.10        | ---  | ---  |
| b   | 0.20        | 0.25 | 0.30 |
| D   | 2.85        | 3.00 | 3.15 |
| D2  | 2.40        | 2.50 | 2.60 |
| E   | 2.85        | 3.00 | 3.15 |
| E2  | 1.70        | 1.80 | 1.90 |
| e   | 0.50 BSC    |      |      |
| k   | 0.19 REF    |      |      |
| L   | 0.35        | 0.40 | 0.45 |
| L3  | ---         | 0.05 | 0.10 |

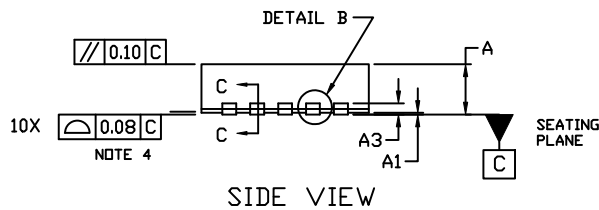

SIDE VIEW

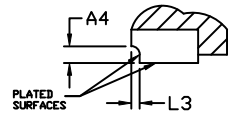

SECTION C-C

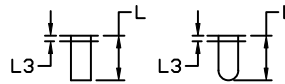

ALTERNATE CONSTRUCTION  
DETAIL A

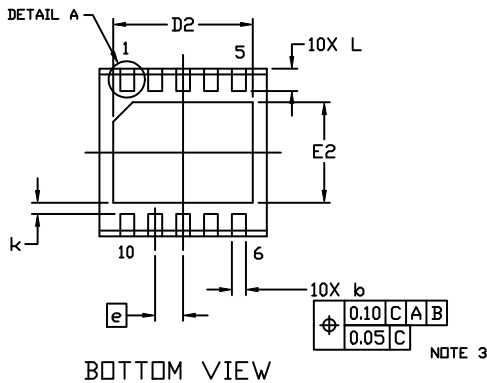

BOTTOM VIEW

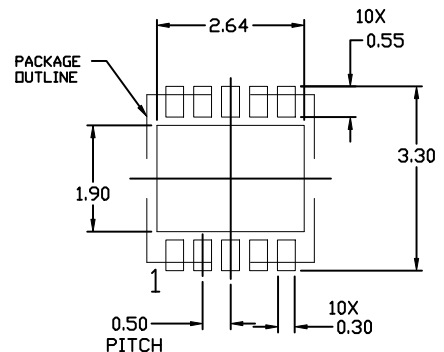

RECOMMENDED MOUNTING FOOTPRINT

#### GENERIC MARKING DIAGRAM\*

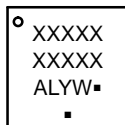

- XXXXX = Specific Device Code
- A = Assembly Location
- L = Wafer Lot
- Y = Year
- W = Work Week
- = Pb-Free Package

(Note: Microdot may be in either location)

\*This information is generic. Please refer to device data sheet for actual part marking. Pb-Free indicator, "G" or microdot "▪", may or may not be present. Some products may not follow the Generic Marking.

|                         |                         |  |
|-------------------------|-------------------------|--|
| <b>DOCUMENT NUMBER:</b> | <b>98AON85414G</b>      | Electronic versions are uncontrolled except when accessed directly from the Document Repository. Printed versions are uncontrolled except when stamped "CONTROLLED COPY" in red. |
| <b>DESCRIPTION:</b>     | <b>DFNW10 3x3, 0.5P</b> | <b>PAGE 1 OF 1</b>   |

ON Semiconductor and are trademarks of Semiconductor Components Industries, LLC dba ON Semiconductor or its subsidiaries in the United States and/or other countries. ON Semiconductor reserves the right to make changes without further notice to any products herein. ON Semiconductor makes no warranty, representation or guarantee regarding the suitability of its products for any particular purpose, nor does ON Semiconductor assume any liability arising out of the application or use of any product or circuit, and specifically disclaims any and all liability, including without limitation special, consequential or incidental damages. ON Semiconductor does not convey any license under its patent rights nor the rights of others.