



# NPN SILICON GERMANIUM RF TRANSISTOR

# NESG270034

## NPN SiGe RF TRANSISTOR FOR MEDIUM OUTPUT POWER AMPLIFICATION (2 W) 3-PIN POWER MINIMOLD (34 PKG)

### FEATURES

- This product is suitable for medium output power (2 W) amplification
  - $P_{out} = 33.5 \text{ dBm TYP. @ } V_{CE} = 6 \text{ V, } P_{in} = 20 \text{ dBm, } f = 460 \text{ MHz}$
  - $P_{out} = 31.5 \text{ dBm TYP. @ } V_{CE} = 6 \text{ V, } P_{in} = 20 \text{ dBm, } f = 900 \text{ MHz}$
- Using UHS2-HV process (SiGe technology),  $V_{CBO}$  (ABSOLUTE MAXIMUM RATINGS) = 25 V
- 3-pin power minimold (34 PKG)

### ORDERING INFORMATION

Part Number	Order Number	Package	Quantity	Supplying Form
NESG270034	NESG270034-AZ	3-pin power minimold (34 PKG) (Pb-Free) <sup>Note</sup>	25 pcs (Non reel)	• Magazine case
NESG270034-T1	NESG270034-T1-AZ		1 kpcs/reel	• 12 mm wide embossed taping • Pin 2 (Emitter) face the perforation side of the tape

<R> **Note** Contains Lead in the part except the electrode terminals.

**Remark** To order evaluation samples, contact your nearby sales office.  
Unit sample quantity is 25 pcs.

### ABSOLUTE MAXIMUM RATINGS ( $T_A = +25^\circ\text{C}$ )

Parameter	Symbol	Ratings	Unit
Collector to Base Voltage	$V_{CBO}$	25	V
Collector to Emitter Voltage	$V_{CEO}$	9.2	V
Emitter to Base Voltage	$V_{EBO}$	2.8	V
Collector Current	$I_C$	750	mA
Total Power Dissipation	$P_{tot}$ <sup>Note</sup>	1.9	W
Junction Temperature	$T_j$	150	$^\circ\text{C}$
Storage Temperature	$T_{stg}$	-65 to +150	$^\circ\text{C}$

**Note** Mounted on  $34.2 \text{ cm}^2 \times 0.8 \text{ mm (t)}$  glass epoxy PWB

**Caution: Observe precautions when handling because these devices are sensitive to electrostatic discharge**

The information in this document is subject to change without notice. Before using this document, please confirm that this is the latest version.

**THERMAL RESISTANCE (T<sub>A</sub> = +25°C)**

Parameter	Symbol	Ratings	Unit
Thermal Resistance from Junction to Ambient <sup>Note</sup>	R <sub>thj-a</sub>	65	°C/W

**Note** Mounted on 34.2 cm<sup>2</sup> × 0.8 mm (t) glass epoxy PWB

**RECOMMENDED OPERATING RANGE (T<sub>A</sub> = +25°C)**

Parameter	Symbol	MIN.	TYP.	MAX.	Unit
Collector to Emitter Voltage	V <sub>CE</sub>	–	6.0	7.2	V
Collector Current	I <sub>c</sub>	–	600	750	mA
Input Power <sup>Note</sup>	P <sub>in</sub>	–	20	23	dBm

**Note** Input power under conditions of V<sub>CE</sub> ≤ 6.0 V, f = 460 MHz

**ELECTRICAL CHARACTERISTICS (T<sub>A</sub> = +25°C)**

Parameter	Symbol	Test Conditions	MIN.	TYP.	MAX.	Unit
<b>DC Characteristics</b>						
Collector Cut-off Current	I <sub>CBO</sub>	V <sub>CB</sub> = 9.2 V, I <sub>E</sub> = 0 mA	–	–	1	μA
Emitter Cut-off Current	I <sub>EBO</sub>	V <sub>EB</sub> = 1.0 V, I <sub>C</sub> = 0 mA	–	–	1	μA
DC Current Gain	h <sub>FE</sub> <sup>Note</sup>	V <sub>CE</sub> = 3 V, I <sub>C</sub> = 100 mA	80	120	180	–
<b>RF Characteristics</b>						
Linner Gain (1)	G <sub>L</sub>	V <sub>CE</sub> = 6 V, I <sub>C (set)</sub> = 30 mA (RF OFF), f = 460 MHz, P <sub>in</sub> = 0 dBm	17.5	19.5	–	dB
Linner Gain (2)	G <sub>L</sub>	V <sub>CE</sub> = 6 V, I <sub>C (set)</sub> = 30 mA (RF OFF), f = 900 MHz, P <sub>in</sub> = 0 dBm	–	15	–	dB
Output Power (1)	P <sub>out</sub>	V <sub>CE</sub> = 6 V, I <sub>C (set)</sub> = 30 mA (RF OFF), f = 460 MHz, P <sub>in</sub> = 20 dBm	31.5	33.5	–	dBm
Output Power (2)	P <sub>out</sub>	V <sub>CE</sub> = 6 V, I <sub>C (set)</sub> = 30 mA (RF OFF), f = 900 MHz, P <sub>in</sub> = 20 dBm	–	31.5	–	dBm
Collector Efficiency (1)	η <sub>C</sub>	V <sub>CE</sub> = 6 V, I <sub>C (set)</sub> = 30 mA (RF OFF), f = 460 MHz, P <sub>in</sub> = 20 dBm	–	60	–	%
Collector Efficiency (2)	η <sub>C</sub>	V <sub>CE</sub> = 6 V, I <sub>C (set)</sub> = 30 mA (RF OFF), f = 900 MHz, P <sub>in</sub> = 20 dBm	–	50	–	%

**Note** Pulse measurement: PW ≤ 350 μs, Duty Cycle ≤ 2%

**h<sub>FE</sub> CLASSIFICATION**

Rank	FB
Marking	SQ
h <sub>FE</sub> Value	80 to 180

<R> TYPICAL CHARACTERISTICS ( $T_A = +25^\circ\text{C}$ , unless otherwise specified)

TOTAL POWER DISSIPATION vs. AMBIENT TEMPERATURE

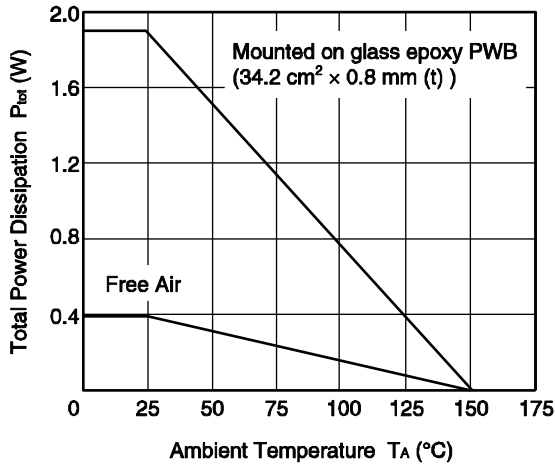

REVERSE TRANSFER CAPACITANCE vs. COLLECTOR TO BASE VOLTAGE

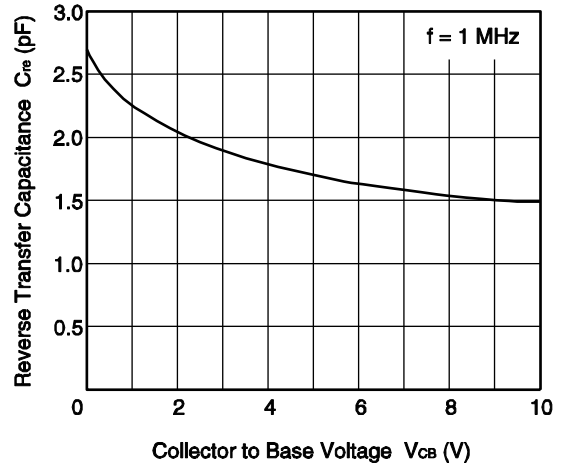

COLLECTOR CURRENT vs. BASE TO EMITTER VOLTAGE

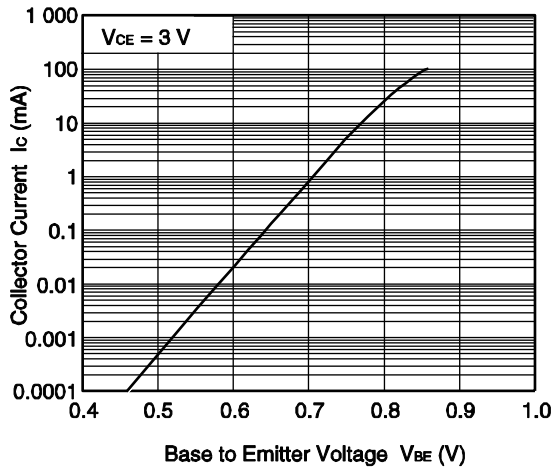

COLLECTOR CURRENT vs. BASE TO EMITTER VOLTAGE

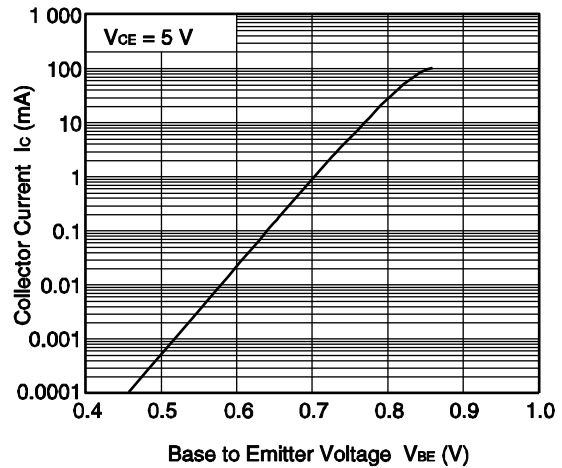

COLLECTOR CURRENT vs. BASE TO EMITTER VOLTAGE

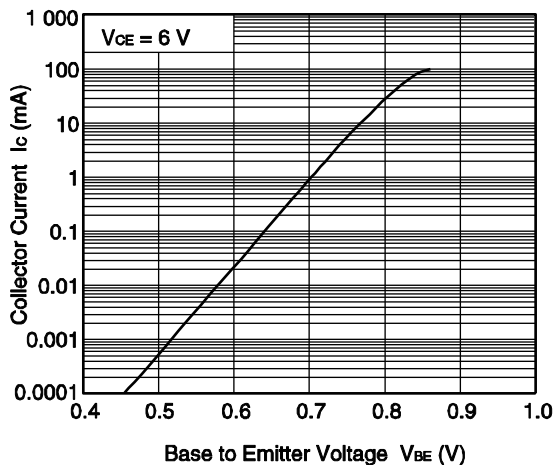

COLLECTOR CURRENT vs. BASE TO EMITTER VOLTAGE

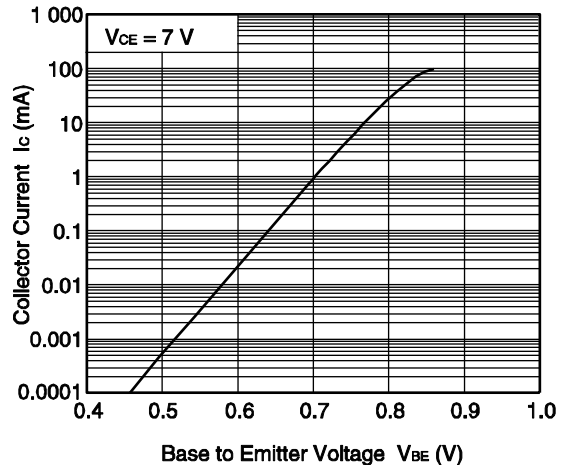

Remark The graph indicates nominal characteristics.

COLLECTOR CURRENT vs. COLLECTOR TO EMITTER VOLTAGE

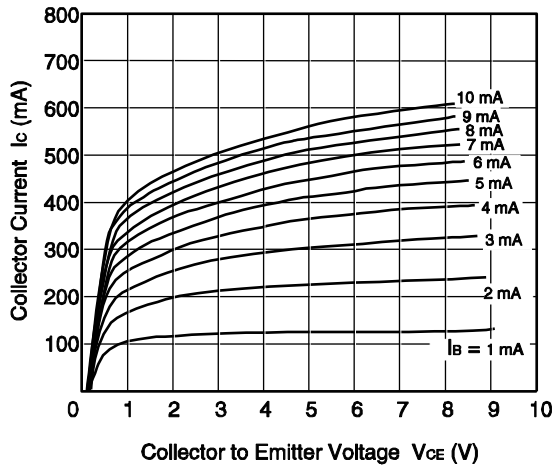

DC CURRENT GAIN vs. COLLECTOR CURRENT

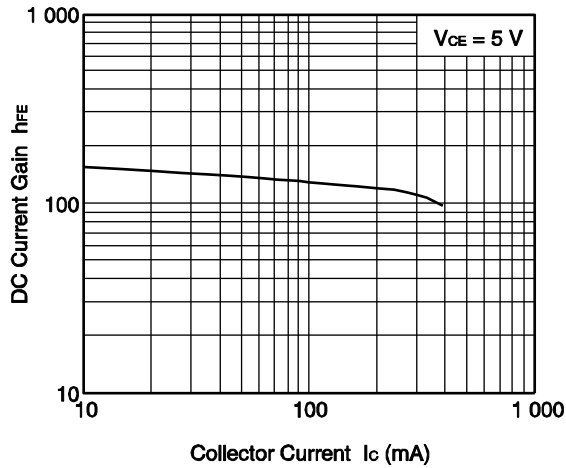

DC CURRENT GAIN vs. COLLECTOR CURRENT

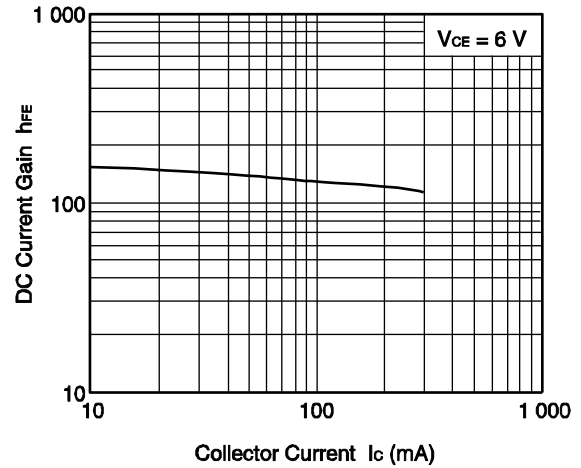

DC CURRENT GAIN vs. COLLECTOR CURRENT

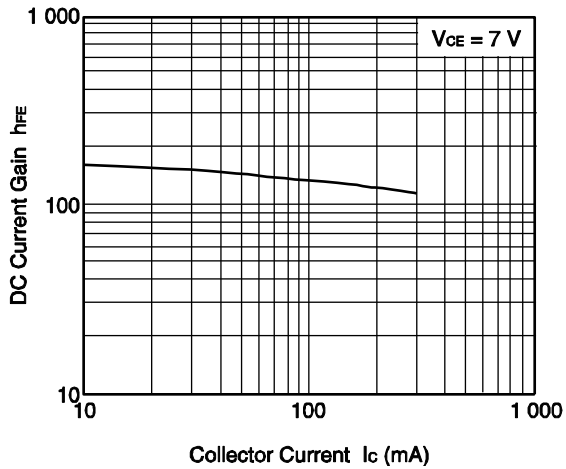

GAIN BANDWIDTH PRODUCT vs. COLLECTOR CURRENT

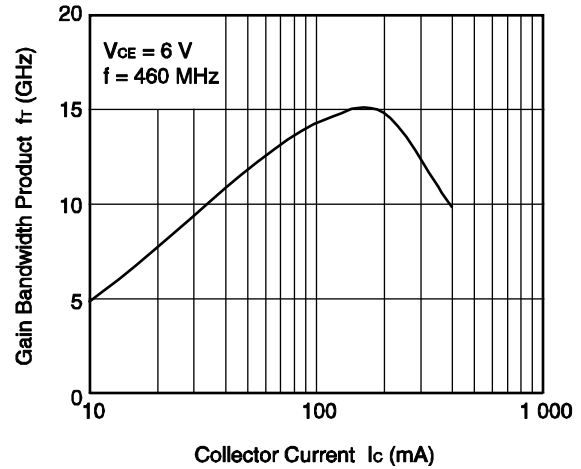

Remark The graph indicates nominal characteristics.

INSERTION POWER GAIN, MAG, MSG vs. FREQUENCY

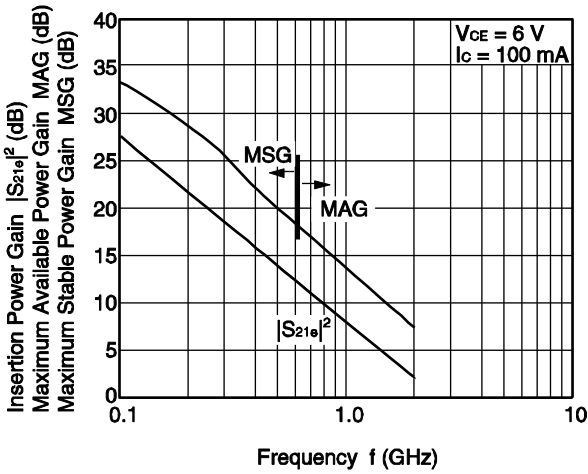

INSERTION POWER GAIN, MAG, MSG vs. FREQUENCY

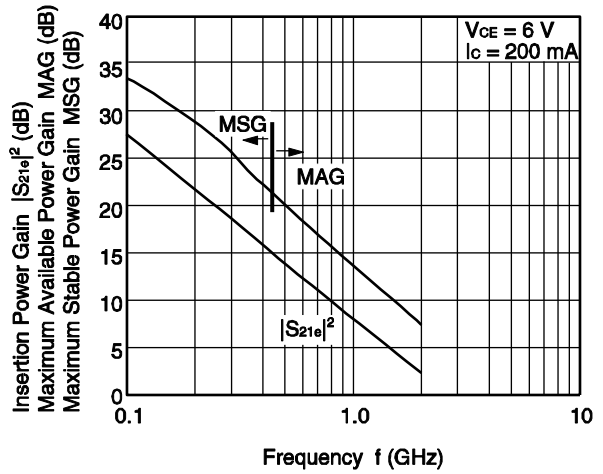

INSERTION POWER GAIN, MAG, MSG vs. FREQUENCY

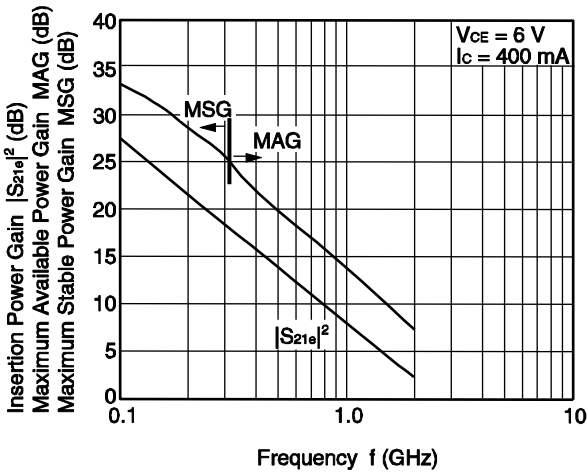

INSERTION POWER GAIN, MAG, MSG vs. COLLECTOR CURRENT

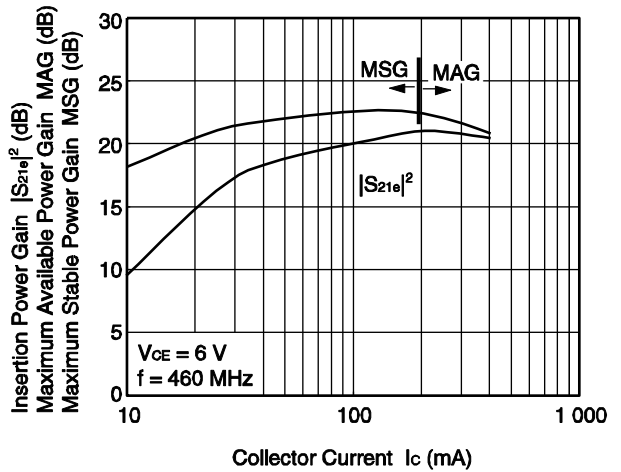

Remark The graph indicates nominal characteristics.

**S-PARAMETERS**

- S-parameters and noise parameters are provided on our Web site in a format (S2P) that enables the direct import of the parameters to microwave circuit simulators without the need for keyboard inputs.
- Click here to download S-parameters.
- [RF and Microwave] ® [Device Parameters]
- URL <http://www.necel.com/microwave/en/>

**PA EVALUATION CIRCUIT TYPICAL CHARACTERISTICS**

**OUTPUT POWER, COLLECTOR CURRENT, COLLECTOR EFFICIENCY vs. INPUT POWER**

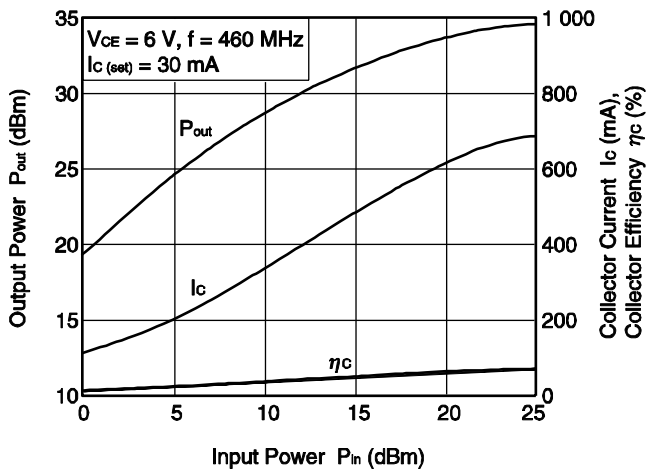

**Remark** The graph indicates nominal characteristics.

EVALUATION CIRCUIT (f = 460 MHz)

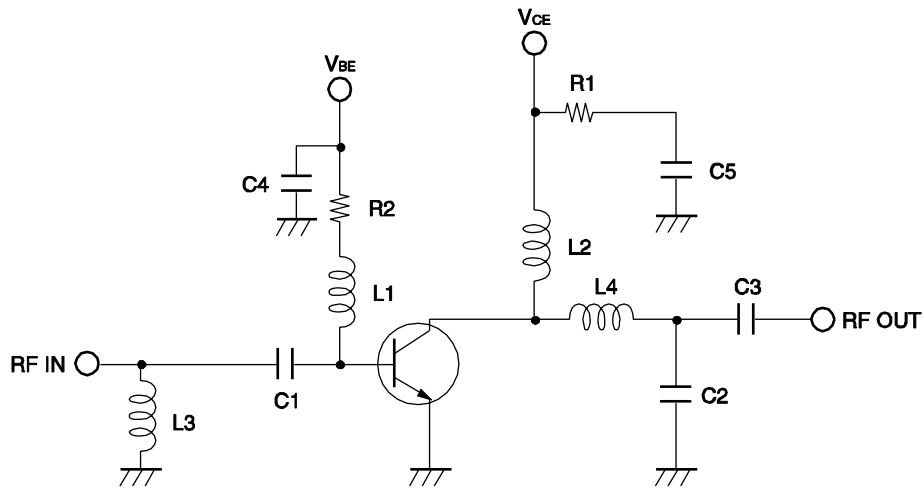

The application circuits and their parameters are for reference only and are not intended for use in actual design-ins.

EVALUATION BOARD (f = 460 MHz)

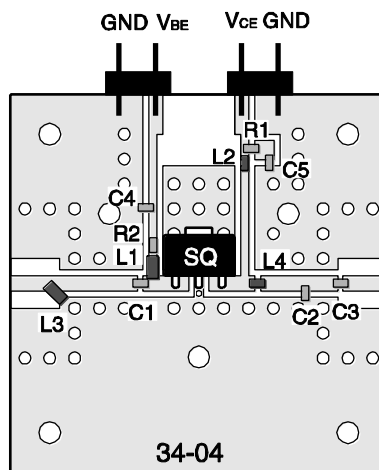

Notes

1. 38 × 38 mm, t = 0.8 mm double sided copper clad glass epoxy PWB.
2. Back side: GND pattern
3. Solder gold plated on pattern
4. ◦ ○: Through holes



**COMPONENT LIST**

Component	Maker	Value	Size (TYPE)	Purpose
C1	Murata	11 pF	1005	Input DC Block/Input RF Matching
C2	Murata	9.5 pF	1005	Input RF Matching
C3	Murata	39 pF	1005	Input DC Block/Output RF Matching
C4	Murata	10 000 pF	1005	RF GND
C5	Murata	10 000 pF	1005	RF GND
L1	Toko	390 nH	2012	RF Block/Input RF Matching
L2	Toko	47 nH	1608	RF Block/Output RF Matching
L3	Toko	5.6 nH	2012	Input RF Matching
L4	Toko	5.1 nH	1608	Output RF Matching
R1	SSM	15 $\Omega$	1005	Improve Stability
R2	SSM	10 $\Omega$	1005	Improve Stability