

# IGBT

## NGTB45N60SWG

This Insulated Gate Bipolar Transistor (IGBT) features a robust and cost effective Field Stop (FS) Trench construction, and provides superior performance in demanding switching applications, offering both low on state voltage and minimal switching loss. The IGBT is well suited for half bridge resonant applications. Incorporated into the device is a soft and fast co-packaged free wheeling diode with a low forward voltage.

### Features

- Low Saturation Voltage using Trench with Fieldstop Technology
- Low Switching Loss Reduces System Power Dissipation
- Low Gate Charge
- Soft, Fast Free Wheeling Diode
- These are Pb-Free Devices

### Typical Applications

- Inductive Heating
- Soft Switching

### ABSOLUTE MAXIMUM RATINGS

Rating	Symbol	Value	Unit
Collector-emitter Voltage	$V_{CES}$	600	V
Collector Current @ $T_C = 25^\circ\text{C}$ @ $T_C = 100^\circ\text{C}$	$I_C$	90 45	A
Pulsed Collector Current, $T_{pulse}$ Limited by $T_{Jmax}$	$I_{CM}$	180	A
Diode Forward Current @ $T_C = 25^\circ\text{C}$ @ $T_C = 100^\circ\text{C}$	$I_F$	90 45	A
Diode Pulsed Current, $T_{pulse}$ Limited by $T_{Jmax}$	$I_{FM}$	180	A
Gate-emitter Voltage	$V_{GE}$	$\pm 20$	V
Power Dissipation @ $T_C = 25^\circ\text{C}$ @ $T_C = 100^\circ\text{C}$	$P_D$	250 50	W
Operating Junction Temperature Range	$T_J$	-55 to +150	$^\circ\text{C}$
Storage Temperature Range	$T_{stg}$	-55 to +150	$^\circ\text{C}$
Lead temperature for soldering, 1/8" from case for 5 seconds	$T_{SLD}$	260	$^\circ\text{C}$

Stresses exceeding those listed in the Maximum Ratings table may damage the device. If any of these limits are exceeded, device functionality should not be assumed, damage may occur and reliability may be affected.

45 A, 600 V  
 $V_{CEsat} = 2.2 \text{ V}$   
 $E_{off} = 0.55 \text{ mJ}$

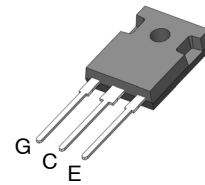
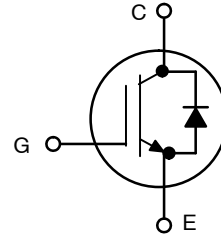

TO-247  
CASE 340AM

### MARKING DIAGRAM

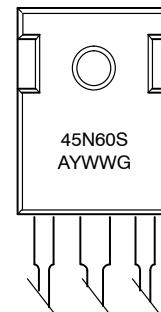

45N60S = Specific Device Code  
A = Assembly Location  
Y = Year  
WW = Work Week  
G = Pb-Free Package

### ORDERING INFORMATION

Device	Package	Shipping
NGTB45N60SWG	TO-247 (Pb-Free)	30 Units / Rail

# NGTB45N60SWG

## THERMAL CHARACTERISTICS

Rating	Symbol	Value	Unit
Thermal resistance junction-to-case, for IGBT	$R_{\theta JC}$	0.87	$^{\circ}\text{C}/\text{W}$
Thermal resistance junction-to-case, for Diode	$R_{\theta JC}$	1.47	$^{\circ}\text{C}/\text{W}$
Thermal resistance junction-to-ambient	$R_{\theta JA}$	40	$^{\circ}\text{C}/\text{W}$

## ELECTRICAL CHARACTERISTICS ( $T_J = 25^{\circ}\text{C}$ unless otherwise specified)

Parameter	Test Conditions	Symbol	Min	Typ	Max	Unit
-----------	-----------------	--------	-----	-----	-----	------

### STATIC CHARACTERISTIC

Collector-emitter breakdown voltage, gate-emitter short-circuited	$V_{GE} = 0\text{ V}, I_C = 500\ \mu\text{A}$	$V_{(BR)CES}$	600	-	-	V
Collector-emitter saturation voltage	$V_{GE} = 15\text{ V}, I_C = 45\text{ A}$ $V_{GE} = 15\text{ V}, I_C = 45\text{ A}, T_J = 150^{\circ}\text{C}$	$V_{CEsat}$	-	2.2 2.6	2.4 -	V
Gate-emitter threshold voltage	$V_{GE} = V_{CE}, I_C = 150\ \mu\text{A}$	$V_{GE(th)}$	4.5	5.5	6.5	V
Collector-emitter cut-off current, gate-emitter short-circuited	$V_{GE} = 0\text{ V}, V_{CE} = 600\text{ V}$ $V_{GE} = 0\text{ V}, V_{CE} = 600\text{ V}, T_J = 150^{\circ}\text{C}$	$I_{CES}$	-	-	0.2 2	mA
Gate leakage current, collector-emitter short-circuited	$V_{GE} = 20\text{ V}, V_{CE} = 0\text{ V}$	$I_{GES}$	-	-	100	nA

### DYNAMIC CHARACTERISTIC

Input capacitance	$V_{CE} = 20\text{ V}, V_{GE} = 0\text{ V}, f = 1\text{ MHz}$	$C_{ies}$	-	3100	-	pF
Output capacitance		$C_{oes}$	-	120	-	
Reverse transfer capacitance		$C_{res}$	-	80	-	
Gate charge total	$V_{CE} = 480\text{ V}, I_C = 45\text{ A}, V_{GE} = 15\text{ V}$	$Q_g$		134		nC
Gate to emitter charge		$Q_{ge}$		27		
Gate to collector charge		$Q_{gc}$		67		

### SWITCHING CHARACTERISTIC, INDUCTIVE LOAD

Turn-on delay time	$T_J = 25^{\circ}\text{C}$ $V_{CC} = 400\text{ V}, I_C = 45\text{ A}$ $R_g = 10\ \Omega$ $V_{GE} = 0\text{ V}/15\text{ V}$	$t_{d(on)}$		70		ns
Rise time		$t_r$		34		
Turn-off delay time		$t_{d(off)}$		144		
Fall time		$t_f$		68		
Turn-off switching loss		$E_{off}$		0.55		
Turn-on delay time	$T_J = 150^{\circ}\text{C}$ $V_{CC} = 400\text{ V}, I_C = 45\text{ A}$ $R_g = 10\ \Omega$ $V_{GE} = 0\text{ V}/15\text{ V}$	$t_{d(on)}$		70		ns
Rise time		$t_r$		39		
Turn-off delay time		$t_{d(off)}$		151		
Fall time		$t_f$		88		
Turn-off switching loss		$E_{off}$		0.89		

### DIODE CHARACTERISTIC

Forward voltage	$V_{GE} = 0\text{ V}, I_F = 20\text{ A}$ $V_{GE} = 0\text{ V}, I_F = 20\text{ A}, T_J = 150^{\circ}\text{C}$	$V_F$		1.1 1.03	1.4	V
Reverse recovery time	$T_J = 25^{\circ}\text{C}$ $I_F = 25\text{ A}, V_R = 200\text{ V}$ $di_F/dt = 200\text{ A}/\mu\text{s}$	$t_{rr}$		376		ns
Reverse recovery charge		$Q_{rr}$		4145		nc
Reverse recovery current		$I_{rrm}$		22		A

Product parametric performance is indicated in the Electrical Characteristics for the listed test conditions, unless otherwise noted. Product performance may not be indicated by the Electrical Characteristics if operated under different conditions.

# NGTB45N60SWG

## TYPICAL CHARACTERISTICS

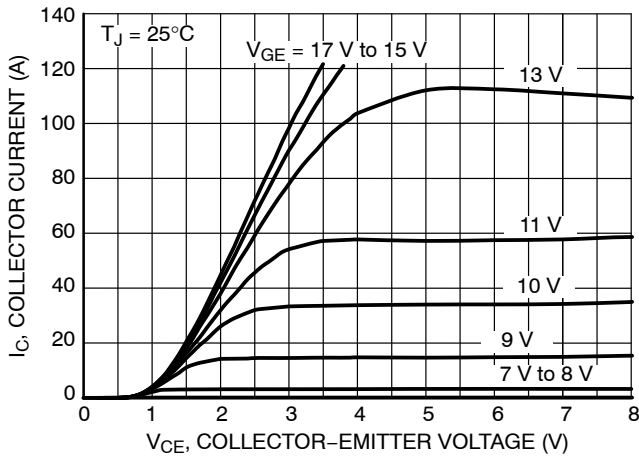

Figure 1. Output Characteristics

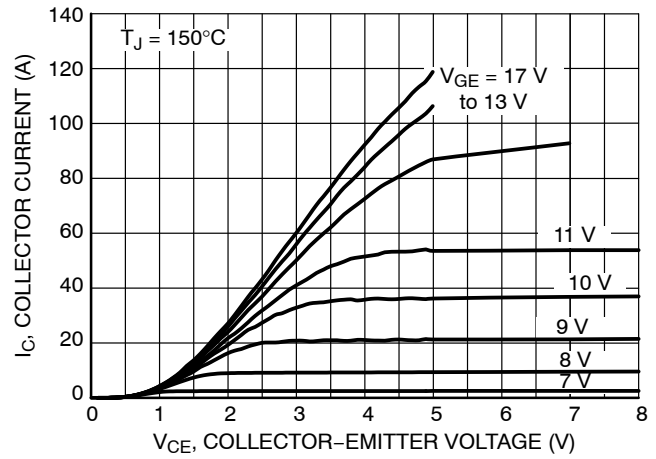

Figure 2. Output Characteristics

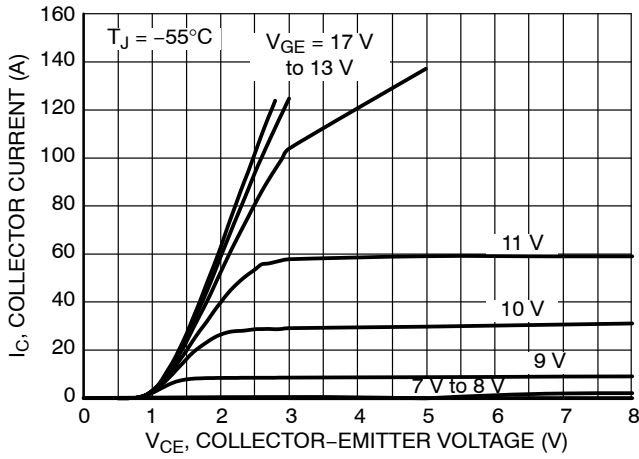

Figure 3. Output Characteristics

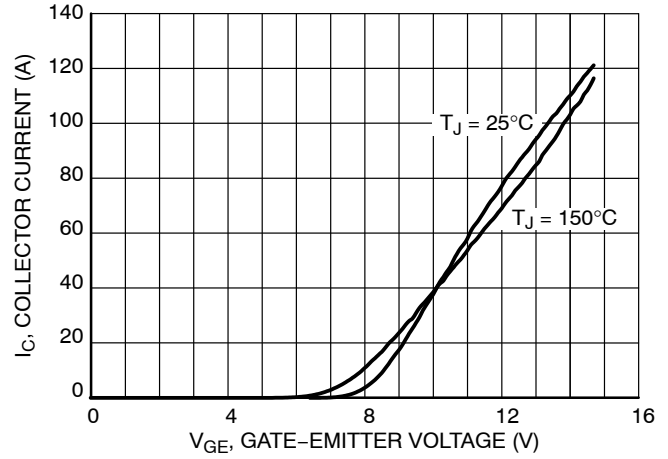

Figure 4. Typical Transfer Characteristics

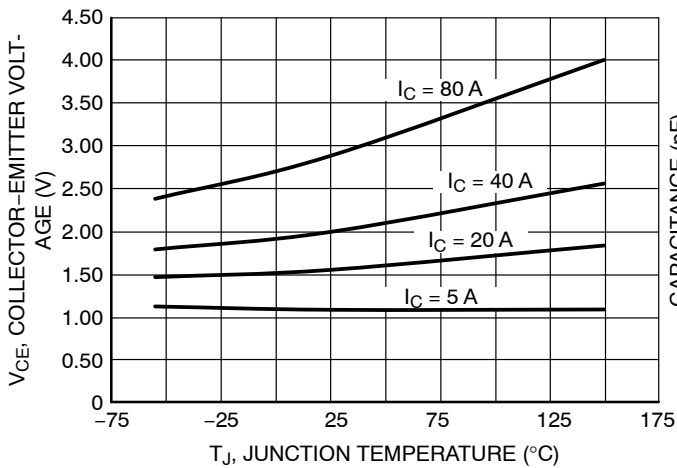

Figure 5.  $V_{CE(sat)}$  vs.  $T_J$

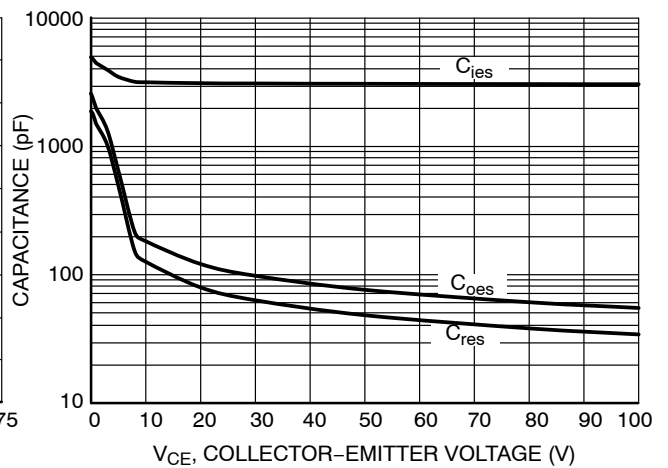

Figure 6. Typical Capacitance

# NGTB45N60SWG

## TYPICAL CHARACTERISTICS

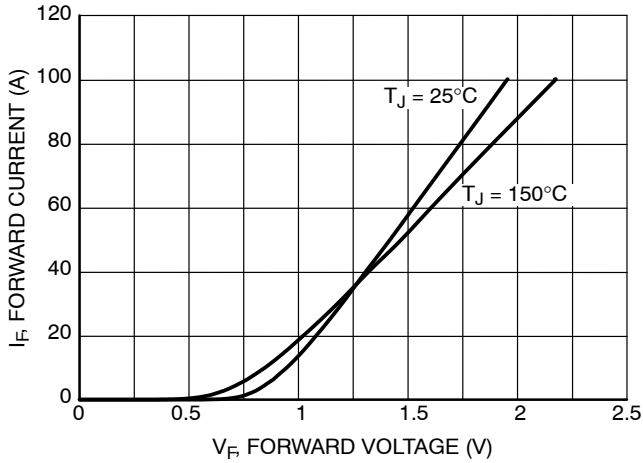

Figure 7. Diode Forward Characteristics

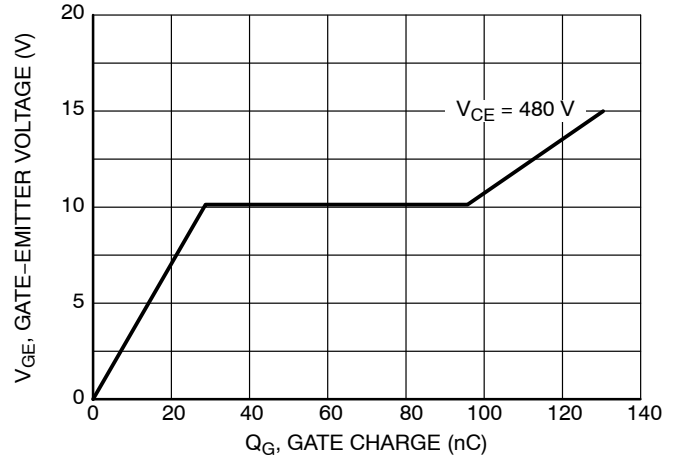

Figure 8. Typical Gate Charge

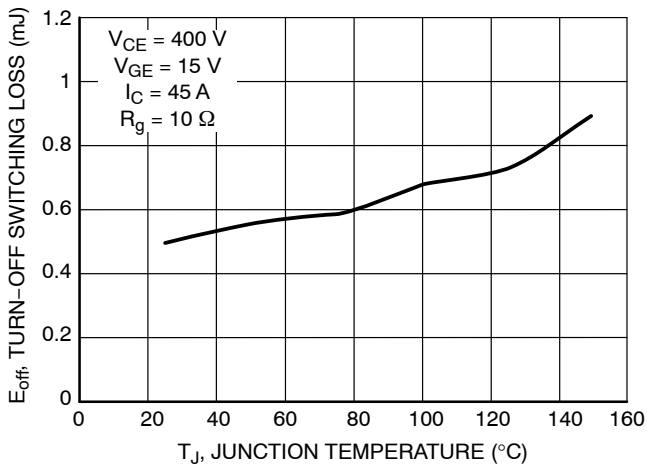

Figure 9. Switching Loss vs. Temperature

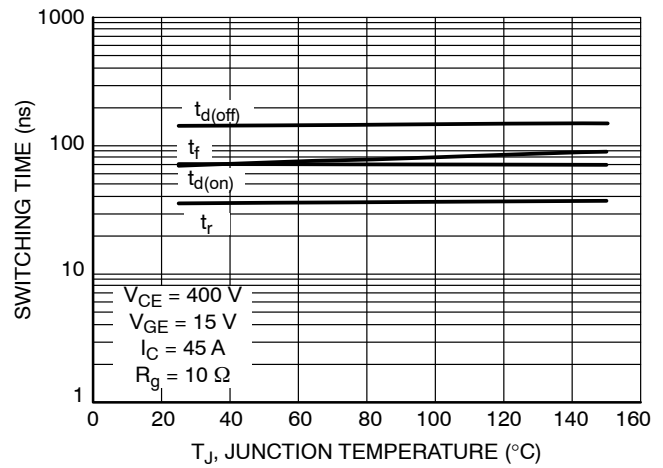

Figure 10. Switching Time vs. Temperature

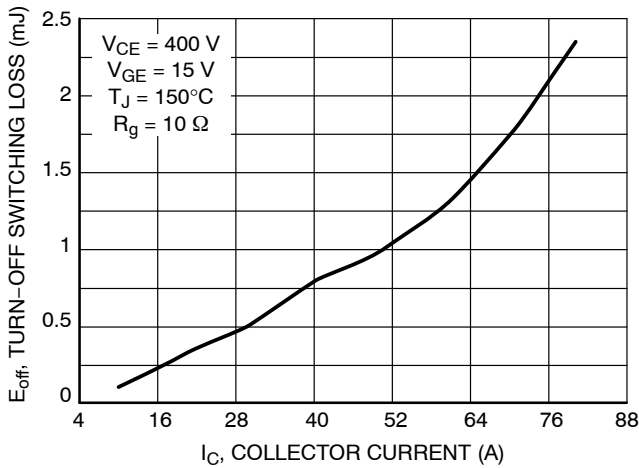

Figure 11. Switching Loss vs.  $I_C$

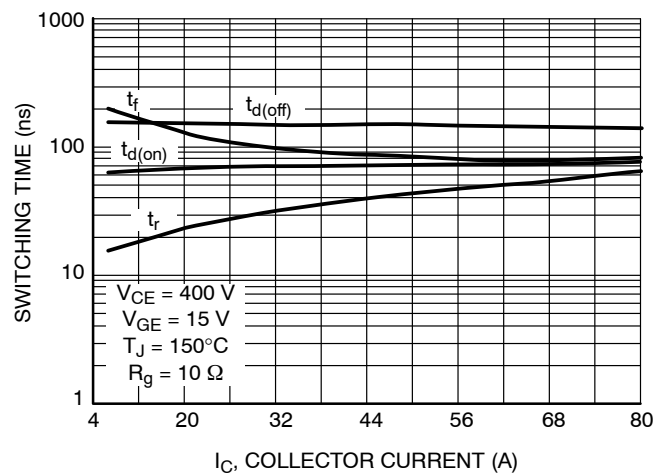

Figure 12. Switching Time vs. Current

# NGTB45N60SWG

## TYPICAL CHARACTERISTICS

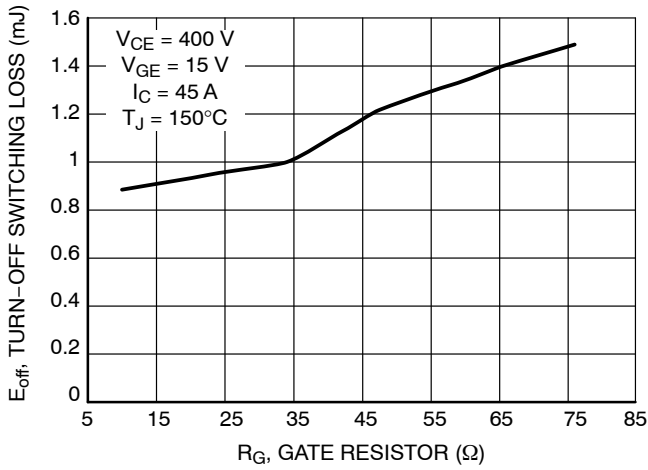

Figure 13. Switching Loss vs.  $R_G$

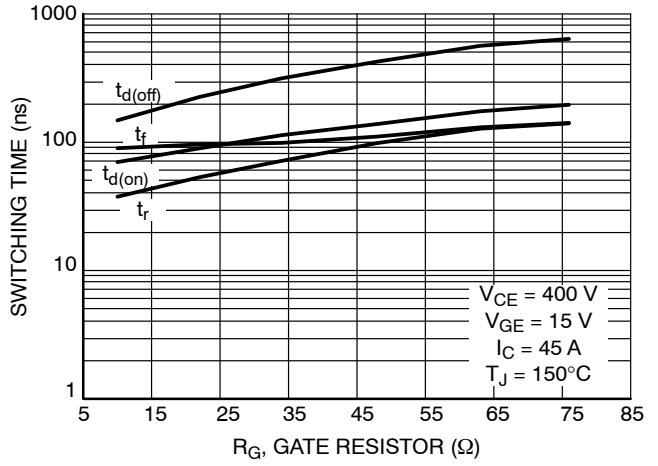

Figure 14. Switching Time vs.  $R_G$

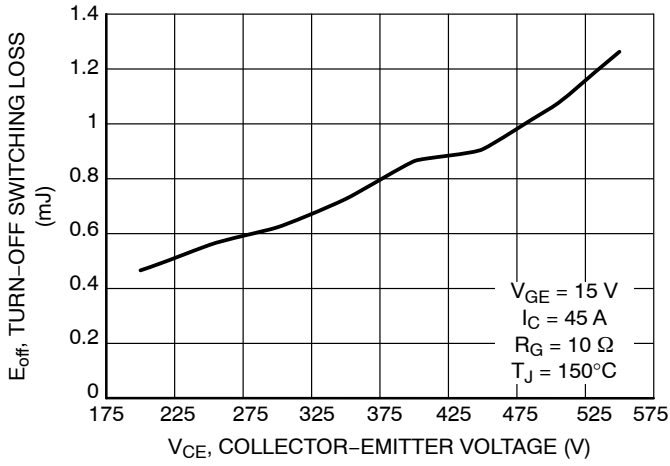

Figure 15. Switching Loss vs.  $V_{CE}$

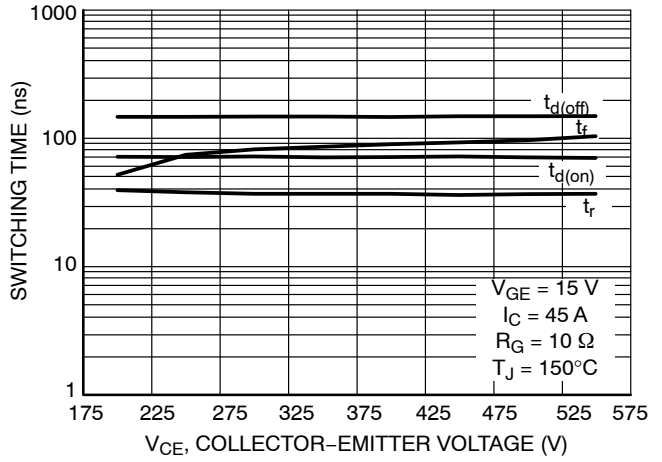

Figure 16. Switching Time vs.  $V_{CE}$

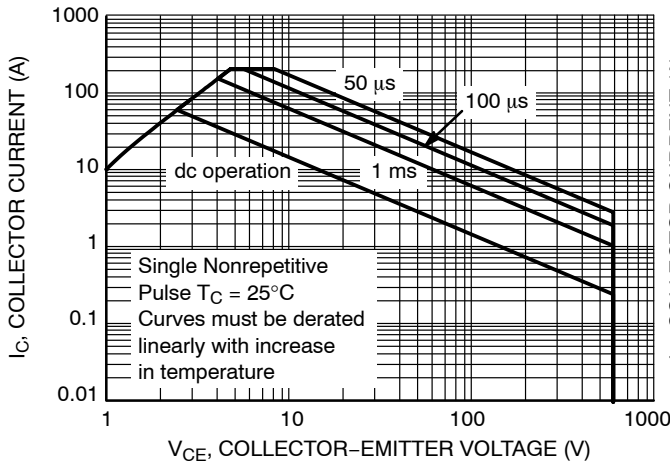

Figure 17. Safe Operating Area

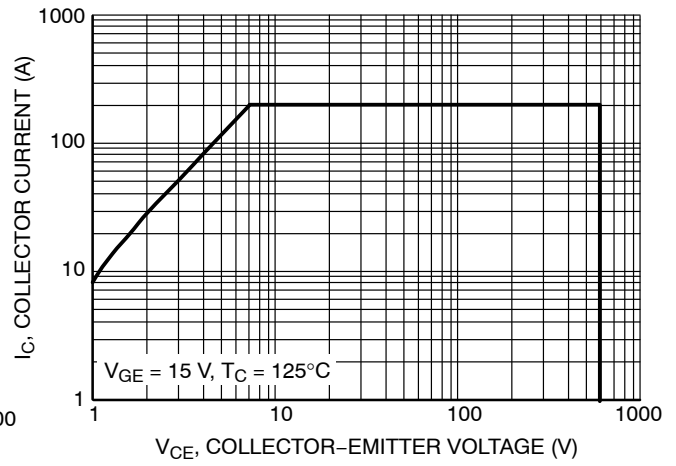

Figure 18. Reverse Bias Safe Operating Area

# NGTB45N60SWG

## TYPICAL CHARACTERISTICS

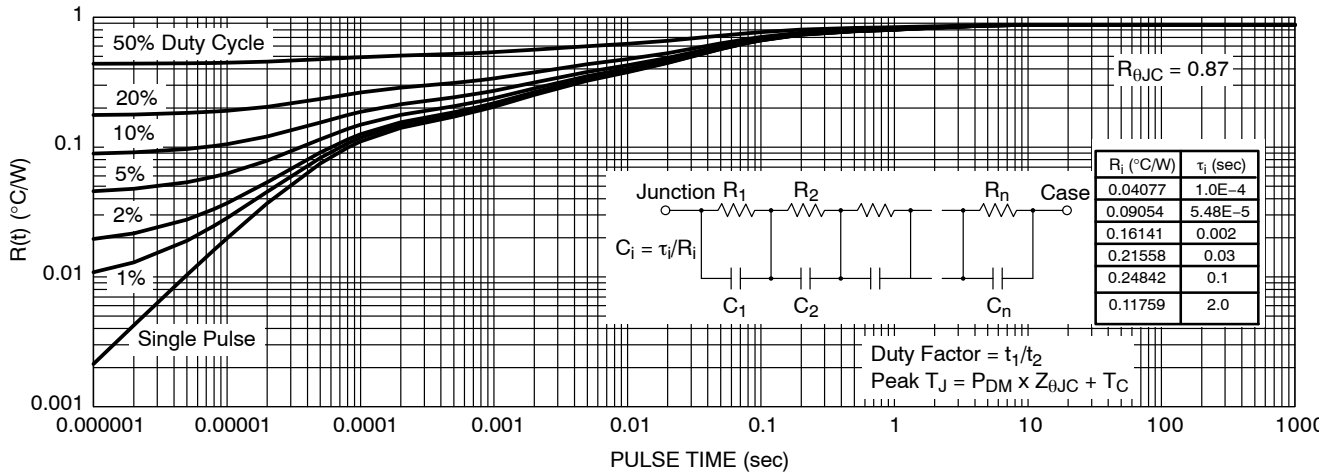

Figure 19. IGBT Transient Thermal Impedance

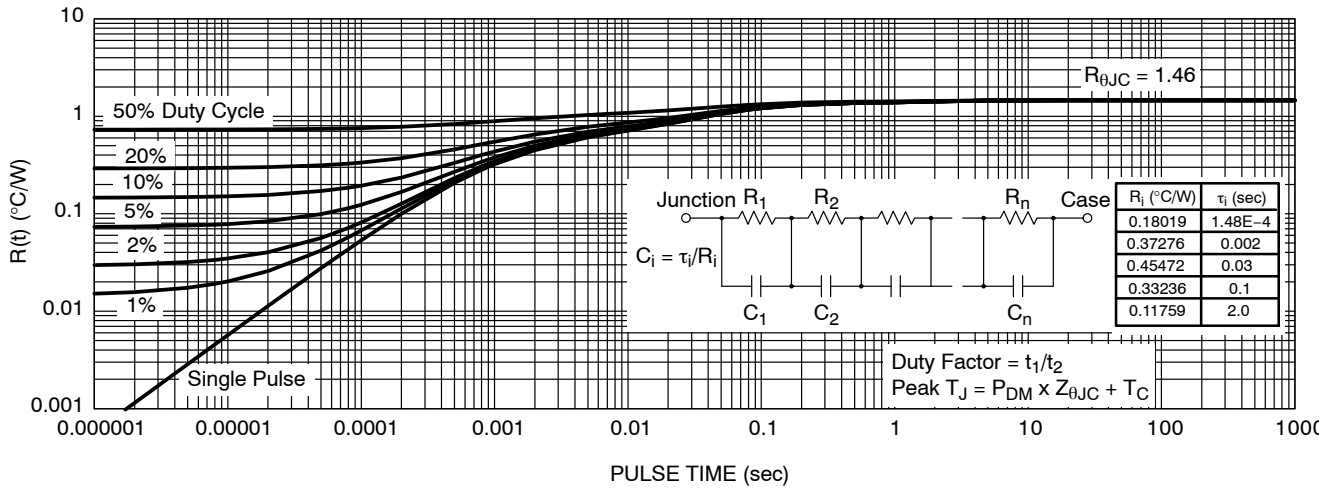

Figure 20. Diode Transient Thermal Impedance

# NGTB45N60SWG

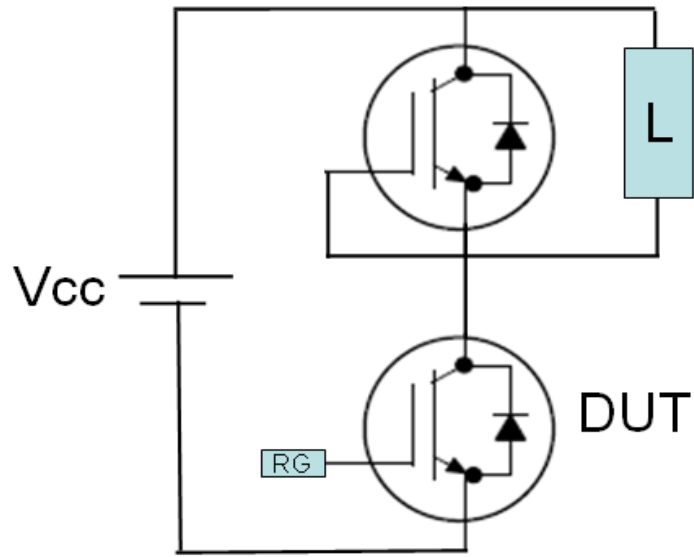

Figure 21. Test Circuit for Switching Characteristics

# NGTB45N60SWG



Figure 22. Definition of Turn On Waveform



# NGTB45N60SWG



Figure 23. Definition of Turn Off Waveform

# MECHANICAL CASE OUTLINE PACKAGE DIMENSIONS

ON Semiconductor®

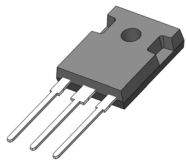

TO-247  
CASE 340AM  
ISSUE C

DATE 07 SEP 2021

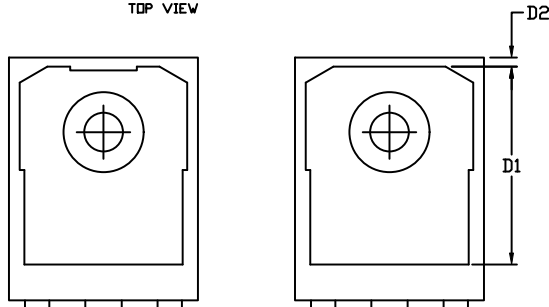
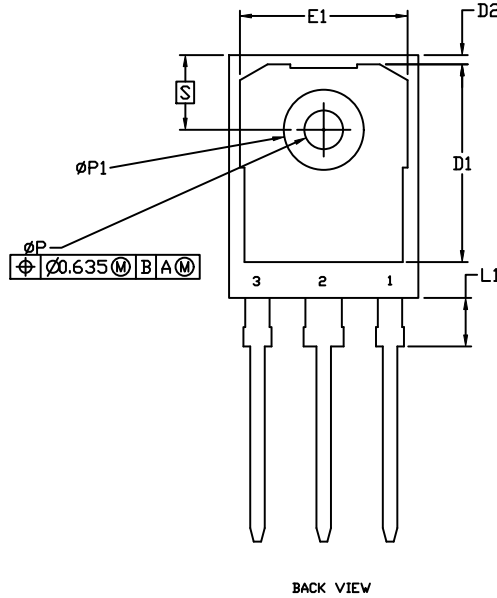
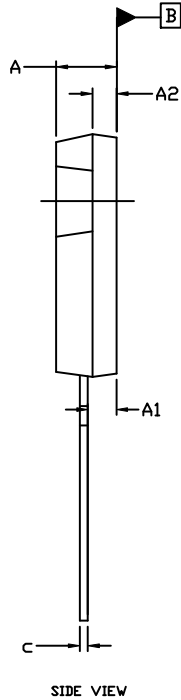
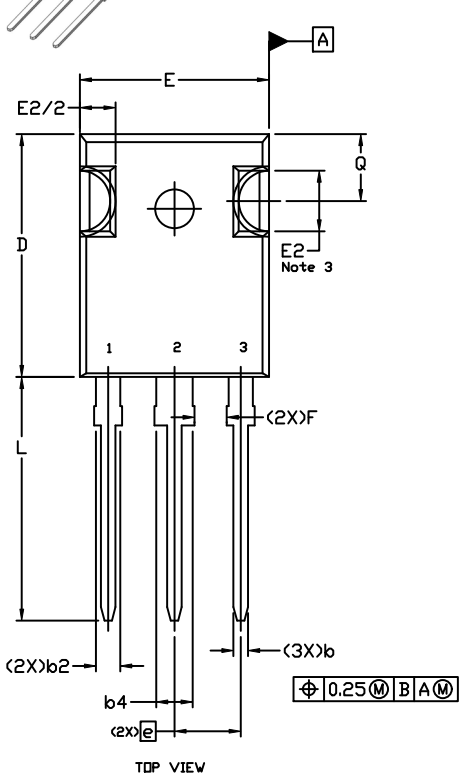

NOTE 4 HEATSINK SHAPES

NOTES:

1. DIMENSIONING AND TOLERANCE AS PER ASME Y14.5M, 2009.
2. ALL DIMENSION ARE IN MILLIMETERS.
3. SLOT REQUIRED, NOTCH MAY BE ROUNDED.
4. OPTIONAL BACK SIDE HEATSINK SHAPE.
5. DIMENSIONS ARE EXCLUSIVE OF BURRS AND MOLD FLASH. DIMENSIONS D AND E ARE MEASURED AT THE OUTERMOST EXTREME OF THE PLASTIC BODY.
6. DIMENSIONS A1 TO BE MEASURED IN THE REGION DEFINED BY L1.
7. LEAD FINISH IS UNCONTROLLED IN THE REGION DEFINED BY L1.

DIM	MILLIMETERS		
	MIN	NOM	MAX
A	4.70	5.00	5.30
A1	2.20	2.40	2.60
A2	1.80	2.00	2.20
b	1.07	1.20	1.33
b2	1.65	2.12	2.35
b4	2.60	3.12	3.40
c	0.45	0.60	0.75
D	20.80	21.00	21.34
D1	16.30	---	---
D2	0.75	---	---
E	15.50	16.00	16.25
E1	13.80	---	---
E2	4.32	4.90	5.49
e	5.45 BSC		
F	2.655	---	---
L	19.80	20.00	20.80
L1	3.81	4.20	4.35
P	3.55	3.60	3.65
P1	6.60	---	---
Q	5.40	6.00	6.20
S	6.15 BSC		

GENERIC MARKING DIAGRAMS\*

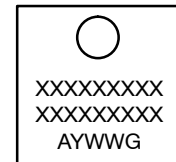
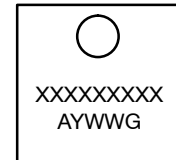

XXXX = Specific Device Code  
 A = Assembly Location  
 Y = Year  
 WW = Work Week  
 G = Pb-Free Package

\*This information is generic. Please refer to device data sheet for actual part marking. Pb-Free indicator, "G" or microdot "•", may or may not be present. Some products may not follow the Generic Marking.

DOCUMENT NUMBER:	98AON77284F	Electronic versions are uncontrolled except when accessed directly from the Document Repository. Printed versions are uncontrolled except when stamped "CONTROLLED COPY" in red.
DESCRIPTION:	TO-247	PAGE 1 OF 1

ON Semiconductor and ON are trademarks of Semiconductor Components Industries, LLC dba ON Semiconductor or its subsidiaries in the United States and/or other countries. ON Semiconductor reserves the right to make changes without further notice to any products herein. ON Semiconductor makes no warranty, representation or guarantee regarding the suitability of its products for any particular purpose, nor does ON Semiconductor assume any liability arising out of the application or use of any product or circuit, and specifically disclaims any and all liability, including without limitation special, consequential or incidental damages. ON Semiconductor does not convey any license under its patent rights nor the rights of others.