

# NLB-310

Cascadable Broadband GaAs MMIC Amplifier  
DC to 10GHz

The NLB-310 cascadable broadband InGaP/GaAs MMIC amplifier is a low-cost, high-performance solution for general purpose RF and microwave amplification needs. This 50Ω gain block is based on a reliable HBT proprietary MMIC design, providing unsurpassed performance for small-signal applications. Designed with an external bias resistor, the NLB-310 provides flexibility and stability. The NLB-310 is packaged in a low cost, surface-mount plastic package, providing ease of assembly for high-volume tape-and-reel requirements.

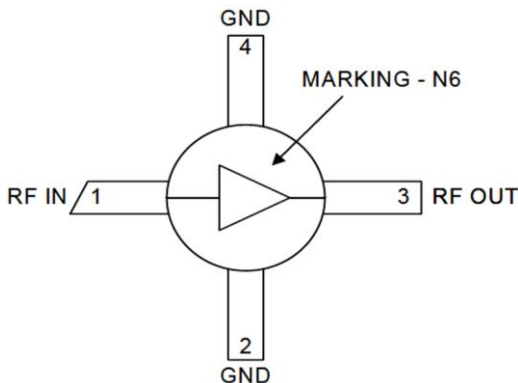

Functional Block Diagram



Package: Micro-X, 4-pin, Plastic

## Features

- Reliable, Low-Cost HBT Design
- 12.7dB Gain, +12.6dBm P1dB at 2Ghz
- High P1dB of +14.9dBm at 6.0GHz +13.1dBm at 10.0GHz
- Single Power Supply Operation
- 50Ω I/O Matched for High Frequency Use

## Applications

- Narrow and Broadband Commercial and Military Radio Designs
- Linear and Saturated Amplifiers
- Gain Stage or Driver Amplifiers for MWRadio/Optical Designs (PTP/PMP/LMDS/UNII/VSAT/WLAN/Cellular/DWDM)

## Ordering Information

|            |  |
|------------|--|
| NLB-310    | Cascadable Broadband GaAs MMIC Amplifier DC to 10GHz |
| NLB-310-T1 | Tape & Reel, 1000 Pieces                             |
| NLB-310-E  | Fully Assembled Evaluation Board                     |
| NBB-X-K1   | Extended Frequency InGaP Amp Designer's Tool Kit     |

## Absolute Maximum Ratings

| Parameter             | Rating      | Unit |
|-----------------------|-------------|------|
| RF Input Power        | +20         | dBm  |
| Power Dissipation     | 300         | mW   |
| Device Current        | 70          | mA   |
| Channel Temperature   | 200         | °C   |
| Operating Temperature | -45 to +85  | °C   |
| Storage Temperature   | -65 to +150 | °C   |

Exceeding any one or a combination of these limits may cause permanent damage.



**Caution!** ESD sensitive device.



RoHS (Restriction of Hazardous Substances): Compliant per EU Directive 2011/65/EU.

Exceeding any one or a combination of the Absolute Maximum Rating conditions may cause permanent damage to the device. Extended application of Absolute Maximum Rating conditions to the device may reduce device reliability. Specified typical performance or functional operation of the device under Absolute Maximum Rating conditions is not implied.

## Nominal Operating Parameters

| Parameter   | Specification |         |     | Unit  | Condition   |
|---|---------------|---------|-----|-------|---|
|   | Min           | Typ     | Max |       |   |
| <b>General Performance</b>                            |               |         |     |       | <b><math>V_D = +4.6V, I_{CC} = 50mA, Z_0 = 50\Omega, T_A = +25^\circ C</math></b> |
| Small Signal Power Gain, S21                          | 12.0          | 12.7    |     | dB    | f = 0.1GHz to 1.0GHz  |
|   |               | 10.7    |     | dB    | f = 1.0GHz to 4.0GHz  |
|   |               | 10.0    |     | dB    | f = 4.0GHz to 6.0GHz  |
|   | 8.5           | 9.7     |     | dB    | f = 6.0GHz to 10.0GHz   |
|   |               | 9.6     |     | dB    | f = 10.0GHz to 12.0GHz  |
| Gain Flatness, GF                                     |               | ±0.3    |     | dB    | f = 5.0GHz to 10.0GHz   |
| Input VSWR  |               | 1.6:1   |     |       | f = 0.1GHz to 4.0GHz  |
|   |               | 1.75:1  |     |       | f = 4.0GHz to 7.0GHz  |
|   |               | 1.6:1   |     |       | f = 7.0GHz to 11.0GHz   |
| Output VSWR   |               | 1.5:1   |     |       | f = 0.1GHz to 4.0GHz  |
|   |               | 1.8:1   |     |       | f = 4.0GHz to 7.0GHz  |
|   |               | 1.6:1   |     |       | f = 7.0GHz to 11.0GHz   |
| Output Power at -1dB Compression, P1dB                |               | 12.6    |     | dBm   | f = 2.0GHz  |
|   |               | 14.9    |     | dBm   | f = 6.0GHz  |
|   |               | 13.1    |     | dBm   | f = 10.0GHz   |
| Noise Figure, NF                                      |               | 5.0     |     | dB    | f = 3.0GHz  |
| Third Order Intercept, IP3                            |               | +28.9   |     | dBm   | f = 2.0GHz  |
|   |               | +27.9   |     |       | f = 6.0GHz  |
| Reverse Isolation, S12                                |               | -17     |     | dB    | f = 0.1GHz to 20.0GHz   |
| Device Voltage, $V_o$                                 | 4.4           | 4.6     | 4.8 | V     |   |
| Gain Temperature Coefficient, $\delta G_T / \delta T$ |               | -0.0015 |     | dB/°C |   |

| Parameter   | Specification |            |     | Unit  | Condition  |
|---|---------------|------------|-----|-------|--|
|   | Min           | Typ        | Max |       |  |
| <b>MTTF versus Temperature at I<sub>CC</sub> = 50mA</b> |               |            |     |       |  |
| Case Temperature  |               | 85         |     | °C    |  |
| Junction Temperature                                    |               | 125        |     | °C    |  |
| MTTF  |               | >1,000,000 |     | hours |  |
| <b>Thermal Resistance</b>                               |               |            |     |       |  |
| θ <sub>JC</sub>   |               | 174        |     | °C/W  | $\frac{J_T - T_{CASE}}{V_D \cdot I_{CC}} = \theta_{JC} (\text{°C/Watt})$ |

### Pin Names and Descriptions

| Pin | Name  | Description  | Interface Schematic |
|-----|-------|--|---------------------|
| 1   | RFIN  | RF input pin. This pin is NOT internally DC blocked. A DC blocking capacitor, suitable for the frequency of operation, should be used in most applications. DC coupling of the input is not allowed, because this will override the internal feedback loop and cause temperature instability.  |                     |
| 2   | GND   | Ground connection. For best performance, keep traces physically short and connect immediately to ground plane.   |                     |
| 3   | RFOUT | RF output and bias pin. Biasing is accomplished with an external series resistor and choke inductor to VCC. The resistor is selected to set the DC current into this pin to a desired level. The resistor value is determined by the following equation:<br>$R = \frac{(V_{CC} - V_{DEVICE})}{I_{CC}}$ Care should also be taken in the resistor selection to ensure that the current into the part never exceeds maximum datasheet operating current over the planned operating temperature. This means that a resistor between the supply and this pin is always required, even if a supply near 5.0V is available, to provide DC feedback to prevent thermal runaway. Because DC is present on this pin, a DC blocking capacitor, suitable for the frequency of operation, should be used in most applications. The supply side of the bias network should also be well bypassed. |                     |
| 4   | GND   | Same as pin 2.   |                     |

### Package Drawing

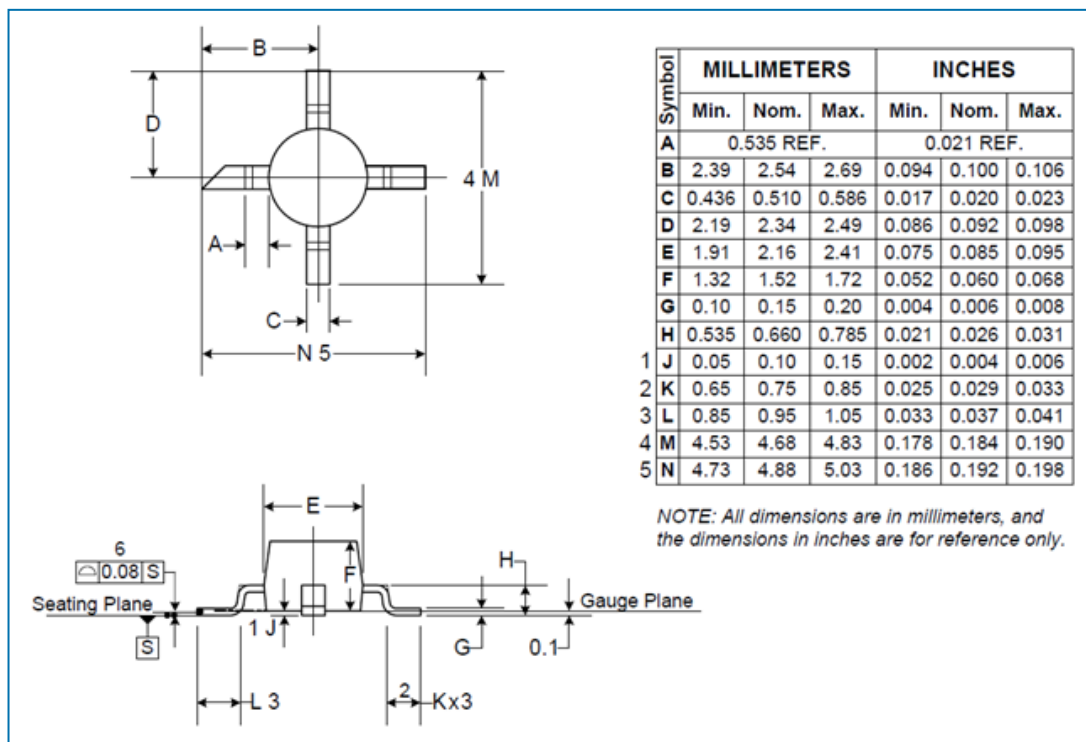

### Typical Bias Configuration

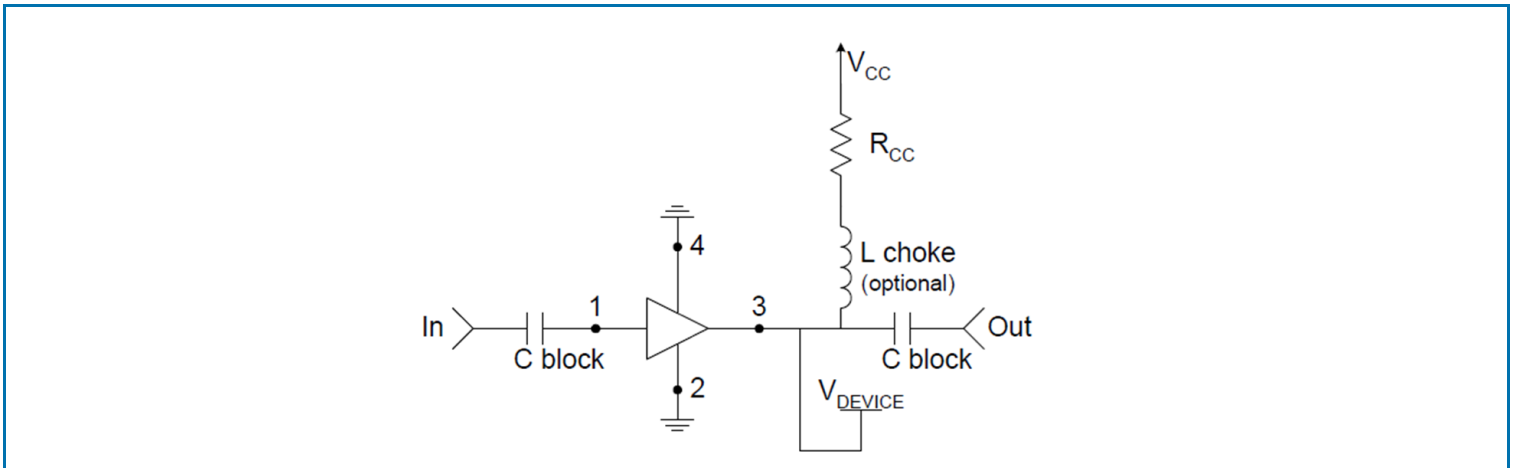

NOTE: Application notes related to biasing circuit, device footprint, and thermal considerations are available on request.

| Recommended Bias Resistor Values     |    |     |     |     |     |
|--------------------------------------|----|-----|-----|-----|-----|
| Supply Voltage, $V_{CC}$ (V)         | 8  | 10  | 12  | 15  | 20  |
| Bias Resistor, $R_{CC}$ ( $\Omega$ ) | 60 | 100 | 140 | 200 | 300 |

### Extended Frequency InGaP Amplifier Designer's Tool Kit (NBB-X-K1)

This tool kit was created to assist in the design-in of the RFMD NBB- and NLB- series InGaP HBT gain block amplifiers. Each tool kit contains the following:

- 5 each NBB-300, NBB-310 and NBB-400 Ceramic Micro-X Amplifiers
- 5 each NLB-300, NLB-310 and NLB-400 Plastic Micro-X Amplifiers
- 2 Broadband Evaluation Boards and High Frequency SMA Connectors
- Broadband Bias Instructions and Specification Summary Index for ease of operation

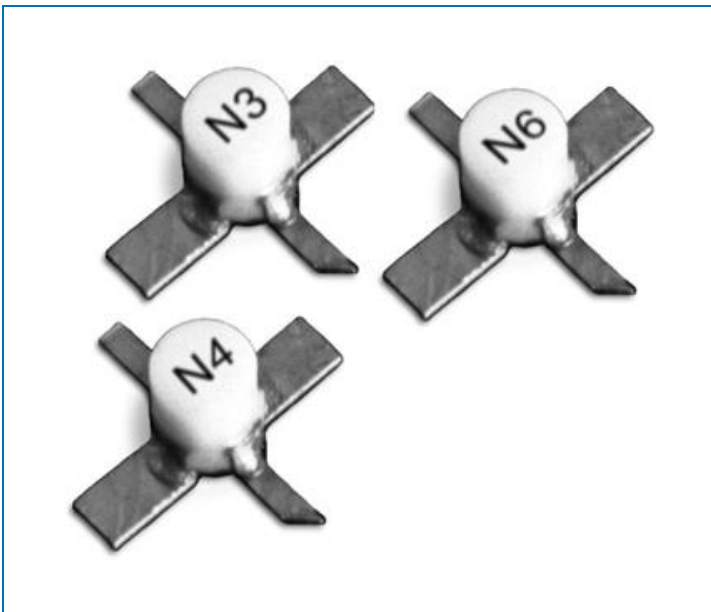

**Tape and Reel Dimensions (all dimensions in millimeters)**

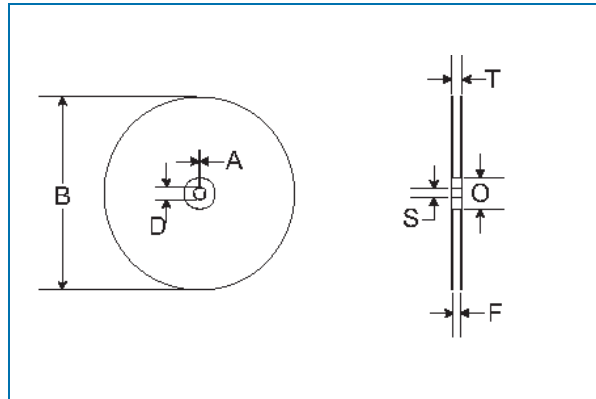

| 14.732 mm (7") REEL |                       | Plastic, Micro-X |                  |                     |
|---------------------|-----------------------|------------------|------------------|---------------------|
|                     | ITEMS                 | SYMBOL           | SIZE (mm)        | SIZE (inches)       |
| FLANGE              | Diameter              | B                | 178 +0.25/-4.0   | 7.0 +0.079/-0.158   |
|                     | Thickness             | T                | 18.4 MAX         | 0.724 MAX           |
|                     | Space Between Flange  | F                | 12.8 +2.0        | 0.50 +0.08          |
| HUB                 | Outer Diameter        | O                | 76.2 REF         | 3.0 REF             |
|                     | Spindle Hole Diameter | S                | 13.716 +0.5/-0.2 | 0.540 +0.020/-0.008 |
|                     | Key Slit Width        | A                | 1.5 MIN          | 0.059 MIN           |
|                     | Key Slit Diameter     | D                | 20.2 MIN         | 0.795 MIN           |

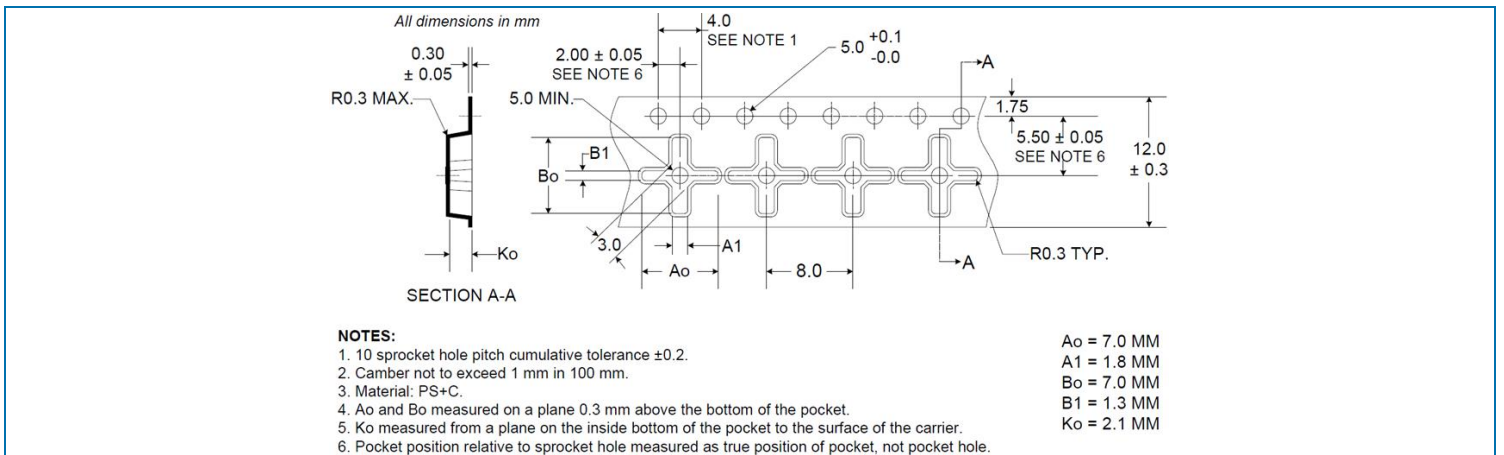
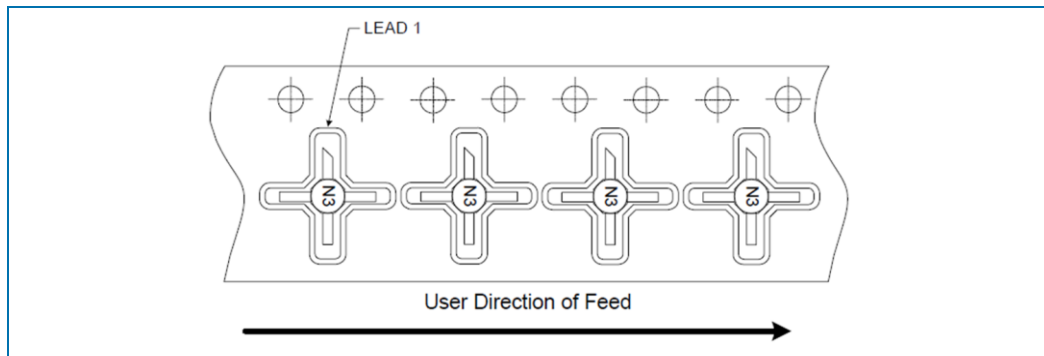

Typical Performance

