

MC74HC04A

Hex Inverter

High-Performance Silicon-Gate CMOS

The MC74HC04A is identical in pinout to the LS04 and the MC14069. The device inputs are compatible with Standard CMOS outputs; with pullup resistors, they are compatible with LSTTL outputs.

The device consists of six three-stage inverters.

Features

- Output Drive Capability: 10 LSTTL Loads
- Outputs Directly Interface to CMOS, NMOS and TTL
- Operating Voltage Range: 2.0 to 6.0 V
- Low Input Current: 1 μ A
- High Noise Immunity Characteristic of CMOS Devices
- In Compliance With the JEDEC Standard No. 7A Requirements
- Chip Complexity: 36 FETs or 9 Equivalent Gates
- NLV Prefix for Automotive and Other Applications Requiring Unique Site and Control Change Requirements; AEC-Q100 Qualified and PPAP Capable
- These Devices are Pb-Free, Halogen Free and are RoHS Compliant

LOGIC DIAGRAM

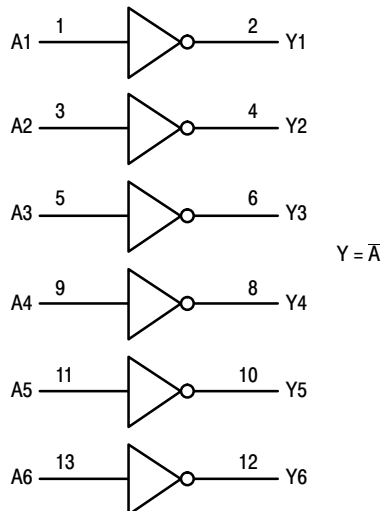

Pinout: 14-Lead Packages (Top View)

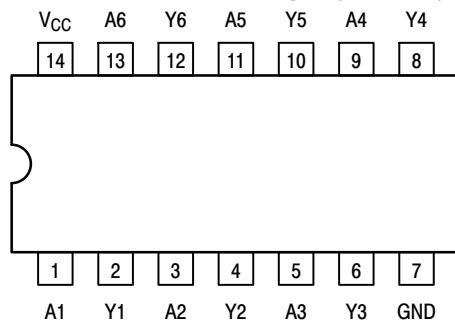

ON Semiconductor[®]

<http://onsemi.com>

MARKING DIAGRAMS

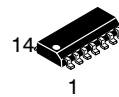

**SOIC-14
D SUFFIX
CASE 751A**

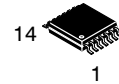
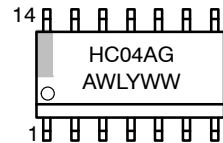

**TSSOP-14
DT SUFFIX
CASE 948G**

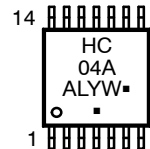

A = Assembly Location
L, WL = Wafer Lot
Y, YY = Year
W, WW = Work Week
G or ■ = Pb-Free Package

(Note: Microdot may be in either location)

FUNCTION TABLE

Inputs	Outputs
A	Y
L	H
H	L

ORDERING INFORMATION

See detailed ordering and shipping information in the package dimensions section on page 2 of this data sheet.

MC74HC04A

MAXIMUM RATINGS

Symbol	Parameter	Value	Unit
V _{CC}	DC Supply Voltage (Referenced to GND)	- 0.5 to + 7.0	V
V _{in}	DC Input Voltage (Referenced to GND)	- 0.5 to V _{CC} + 0.5	V
V _{out}	DC Output Voltage (Referenced to GND)	- 0.5 to V _{CC} + 0.5	V
I _{in}	DC Input Current, per Pin	± 20	mA
I _{out}	DC Output Current, per Pin	± 25	mA
I _{CC}	DC Supply Current, V _{CC} and GND Pins	± 50	mA
P _D	Power Dissipation in Still Air, SOIC Package† TSSOP Package†	500 450	mW
T _{stg}	Storage Temperature	- 65 to + 150	°C
T _L	Lead Temperature, 1 mm from Case for 10 Seconds SOIC or TSSOP Package	260	°C

Stresses exceeding Maximum Ratings may damage the device. Maximum Ratings are stress ratings only. Functional operation above the Recommended Operating Conditions is not implied. Extended exposure to stresses above the Recommended Operating Conditions may affect device reliability.

*This device contains protection circuitry to guard against damage due to high static voltages or electric fields. However, precautions must be taken to avoid applications of any voltage higher than maximum rated voltages to this high-impedance circuit. For proper operation, V_{in} and V_{out} should be constrained to the range GND ≤ (V_{in} or V_{out}) ≤ V_{CC}. Unused inputs must always be tied to an appropriate logic voltage level (e.g., either GND or V_{CC}). Unused outputs must be left open.

†Derating - SOIC Package: - 7 mW/°C from 65° to 125°C
TSSOP Package: - 6.1 mW/°C from 65° to 125°C

RECOMMENDED OPERATING CONDITIONS

Symbol	Parameter	Min	Max	Unit
V _{CC}	DC Supply Voltage (Referenced to GND)	2.0	6.0	V
V _{in} , V _{out}	DC Input Voltage, Output Voltage (Referenced to GND)	0	V _{CC}	V
T _A	Operating Temperature, All Package Types	- 55	+ 125	°C
t _r , t _f	Input Rise and Fall Time (Figure 1)	V _{CC} = 2.0 V 0 0	1000 500 400	ns

ORDERING INFORMATION

Device	Package	Shipping†
MC74HC04ADG	SOIC-14 (Pb-Free)	55 Units / Rail
MC74HC04ADR2G	SOIC-14 (Pb-Free)	2500 / Tape & Reel
MC74HC04ADTR2G	TSSOP-14 (Pb-Free)	2500 / Tape & Reel
NLV74HC04ADG*	SOIC-14 (Pb-Free)	55 Units / Rail
NLV74HC04ADR2G*	SOIC-14 (Pb-Free)	2500 / Tape & Reel
NLV74HC04ADTR2G*	TSSOP-14 (Pb-Free)	2500 / Tape & Reel

†For information on tape and reel specifications, including part orientation and tape sizes, please refer to our Tape and Reel Packaging Specifications Brochure, BRD8011/D.

*NLV Prefix for Automotive and Other Applications Requiring Unique Site and Control Change Requirements; AEC-Q100 Qualified and PPAP Capable

MC74HC04A

DC CHARACTERISTICS (Voltages Referenced to GND)

Symbol	Parameter	Condition	V _{CC} V	Guaranteed Limit			Unit
				-55 to 25°C	≤85°C	≤125°C	
V _{IH}	Minimum High-Level Input Voltage	V _{out} = 0.1V or V _{CC} - 0.1V I _{out} ≤ 20μA	2.0	1.50	1.50	1.50	V
			3.0	2.10	2.10	2.10	
			4.5	3.15	3.15	3.15	
			6.0	4.20	4.20	4.20	
V _{IL}	Maximum Low-Level Input Voltage	V _{out} = 0.1V or V _{CC} - 0.1V I _{out} ≤ 20μA	2.0	0.50	0.50	0.50	V
			3.0	0.90	0.90	0.90	
			4.5	1.35	1.35	1.35	
			6.0	1.80	1.80	1.80	
V _{OH}	Minimum High-Level Output Voltage	V _{in} = V _{IH} or V _{IL} I _{out} ≤ 20μA	2.0	1.9	1.9	1.9	V
			4.5	4.4	4.4	4.4	
			6.0	5.9	5.9	5.9	
		V _{in} = V _{IH} or V _{IL} I _{out} ≤ 2.4mA I _{out} ≤ 4.0mA I _{out} ≤ 5.2mA	3.0	2.48	2.34	2.20	
			4.5	3.98	3.84	3.70	
			6.0	5.48	5.34	5.20	
V _{OL}	Maximum Low-Level Output Voltage	V _{in} = V _{IH} or V _{IL} I _{out} ≤ 20μA	2.0	0.1	0.1	0.1	V
			4.5	0.1	0.1	0.1	
			6.0	0.1	0.1	0.1	
		V _{in} = V _{IH} or V _{IL} I _{out} ≤ 2.4mA I _{out} ≤ 4.0mA I _{out} ≤ 5.2mA	3.0	0.26	0.33	0.40	
			4.5	0.26	0.33	0.40	
			6.0	0.26	0.33	0.40	
I _{in}	Maximum Input Leakage Current	V _{in} = V _{CC} or GND	6.0	± 0.1	± 1.0	± 1.0	μA
I _{CC}	Maximum Quiescent Supply Current (per Package)	V _{in} = V _{CC} or GND I _{out} = 0μA	6.0	1.0	10	40	μA

AC CHARACTERISTICS (C_L = 50pF, Input t_r = t_f = 6ns)

Symbol	Parameter	V _{CC} V	Guaranteed Limit			Unit
			-55 to 25°C	≤85°C	≤125°C	
t _{PLH} , t _{PHL}	Maximum Propagation Delay, Input A or B to Output Y (Figures 1 and 2)	2.0	75	95	110	ns
		3.0	30	40	55	
		4.5	15	19	22	
		6.0	13	16	19	
t _{TLH} , t _{THL}	Maximum Output Transition Time, Any Output (Figures 1 and 2)	2.0	75	95	110	ns
		3.0	27	32	36	
		4.5	15	19	22	
		6.0	13	16	19	
C _{in}	Maximum Input Capacitance		10	10	10	pF
C _{PD}	Power Dissipation Capacitance (Per Inverter)*	Typical @ 25°C, V _{CC} = 5.0 V			pF	
		20				

* Used to determine the no-load dynamic power consumption: P_D = C_{PD} V_{CC}²f + I_{CC} V_{CC}.

MC74HC04A

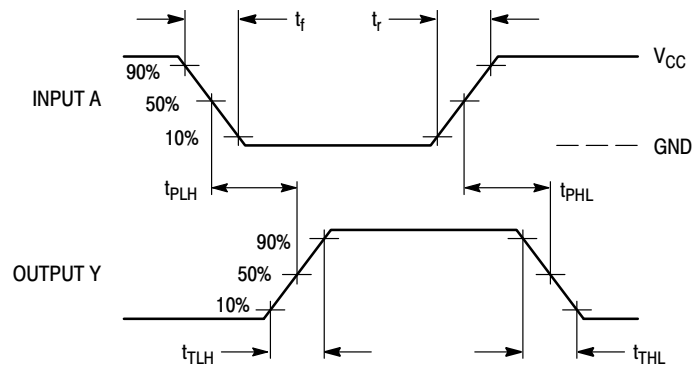
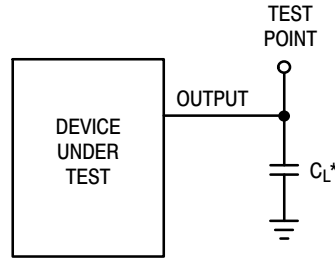

Figure 1. Switching Waveforms



*Includes all probe and jig capacitance

Figure 2. Test Circuit

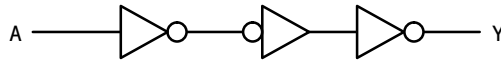
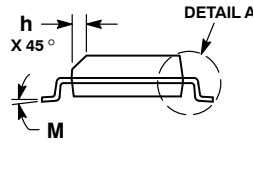
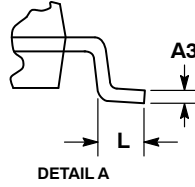
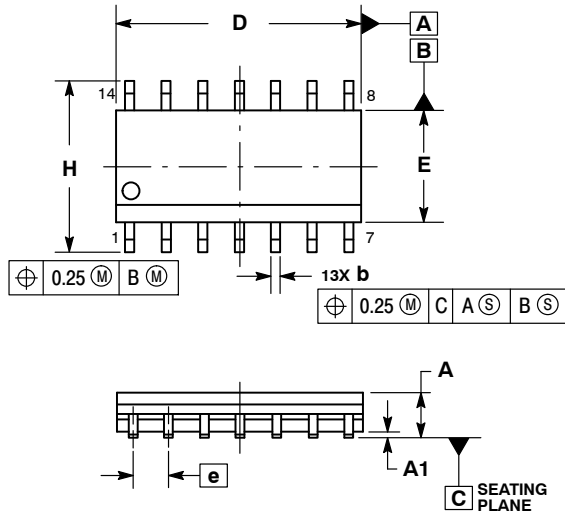

Figure 3. Expanded Logic Diagram
(1/6 of the Device Shown)

MC74HC04A

PACKAGE DIMENSIONS

SOIC-14 NB
CASE 751A-03
ISSUE K



NOTES:

1. DIMENSIONING AND TOLERANCING PER ASME Y14.5M, 1994.
2. CONTROLLING DIMENSION: MILLIMETERS.
3. DIMENSION b DOES NOT INCLUDE DAMBAR PROTRUSION. ALLOWABLE PROTRUSION SHALL BE 0.13 TOTAL IN EXCESS OF AT MAXIMUM MATERIAL CONDITION.
4. DIMENSIONS D AND E DO NOT INCLUDE MOLD PROTRUSIONS.
5. MAXIMUM MOLD PROTRUSION 0.15 PER SIDE.

DIM	MILLIMETERS		INCHES	
	MIN	MAX	MIN	MAX
A	1.35	1.75	0.054	0.068
A1	0.10	0.25	0.004	0.010
A3	0.19	0.25	0.008	0.010
b	0.35	0.49	0.014	0.019
D	8.55	8.75	0.337	0.344
E	3.80	4.00	0.150	0.157
e	1.27 BSC		0.050 BSC	
H	5.80	6.20	0.228	0.244
h	0.25	0.50	0.010	0.019
L	0.40	1.25	0.016	0.049
M	0°	7°	0°	7°

SOLDERING FOOTPRINT*

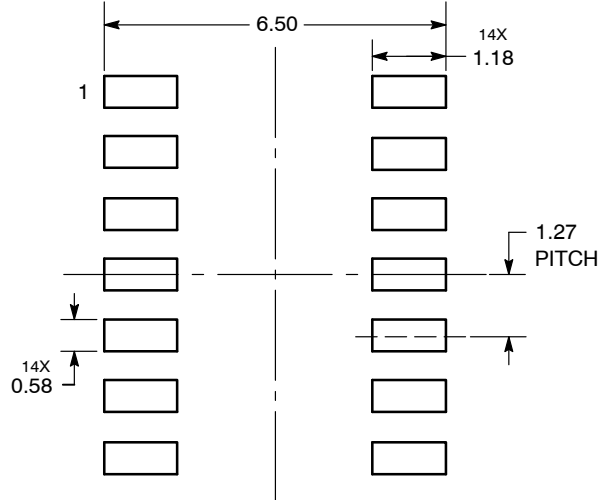

DIMENSIONS: MILLIMETERS

*For additional information on our Pb-Free strategy and soldering details, please download the ON Semiconductor Soldering and Mounting Techniques Reference Manual, SOLDERRM/D.

MC74HC04A

PACKAGE DIMENSIONS

TSSOP-14
DT SUFFIX
CASE 948G-01
ISSUE B

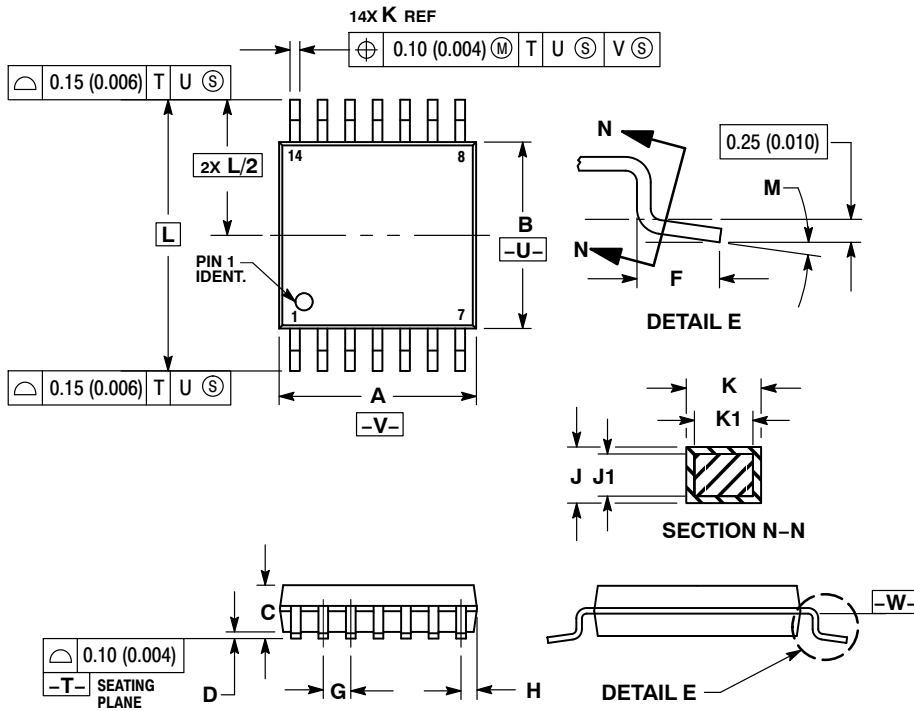

NOTES:

1. DIMENSIONING AND TOLERANCING PER ANSI Y14.5M, 1982.
2. CONTROLLING DIMENSION: MILLIMETER.
3. DIMENSION A DOES NOT INCLUDE MOLD FLASH, PROTRUSIONS OR GATE BURRS. MOLD FLASH OR GATE BURRS SHALL NOT EXCEED 0.15 (0.006) PER SIDE.
4. DIMENSION B DOES NOT INCLUDE INTERLEAD FLASH OR PROTRUSION. INTERLEAD FLASH OR PROTRUSION SHALL NOT EXCEED 0.25 (0.010) PER SIDE.
5. DIMENSION K DOES NOT INCLUDE DAMBAR PROTRUSION. ALLOWABLE DAMBAR PROTRUSION SHALL BE 0.08 (0.003) TOTAL IN EXCESS OF THE K DIMENSION AT MAXIMUM MATERIAL CONDITION.
6. TERMINAL NUMBERS ARE SHOWN FOR REFERENCE ONLY.
7. DIMENSION A AND B ARE TO BE DETERMINED AT DATUM PLANE -V-.

DIM	MILLIMETERS		INCHES	
	MIN	MAX	MIN	MAX
A	4.90	5.10	0.193	0.200
B	4.30	4.50	0.169	0.177
C	---	1.20	---	0.047
D	0.05	0.15	0.002	0.006
F	0.50	0.75	0.020	0.030
G	0.65 BSC		0.026 BSC	
H	0.50	0.60	0.020	0.024
J	0.09	0.20	0.004	0.008
J1	0.09	0.16	0.004	0.006
K	0.19	0.30	0.007	0.012
K1	0.19	0.25	0.007	0.010
L	6.40 BSC		0.252 BSC	
M	0°	8°	0°	8°

SOLDERING FOOTPRINT*

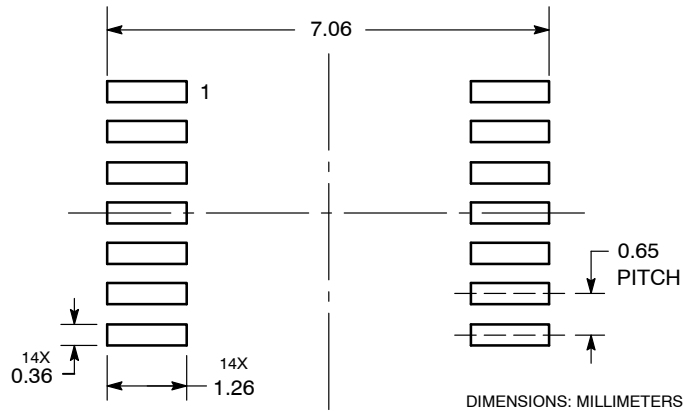

*For additional information on our Pb-Free strategy and soldering details, please download the ON Semiconductor Soldering and Mounting Techniques Reference Manual, SOLDERRM/D.

MECHANICAL CASE OUTLINE PACKAGE DIMENSIONS

ON Semiconductor®

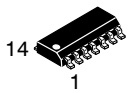

SCALE 1:1

SOIC-14 NB
CASE 751A-03
ISSUE L

DATE 03 FEB 2016

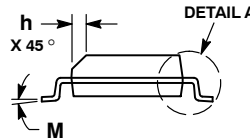
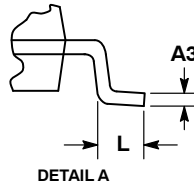
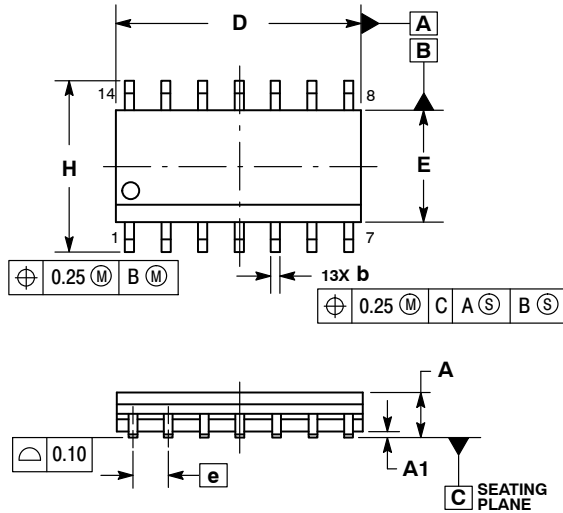

NOTES:

1. DIMENSIONING AND TOLERANCING PER ASME Y14.5M, 1994.
2. CONTROLLING DIMENSION: MILLIMETERS.
3. DIMENSION b DOES NOT INCLUDE DAMBAR PROTRUSION. ALLOWABLE PROTRUSION SHALL BE 0.13 TOTAL IN EXCESS OF AT MAXIMUM MATERIAL CONDITION.
4. DIMENSIONS D AND E DO NOT INCLUDE MOLD PROTRUSIONS.
5. MAXIMUM MOLD PROTRUSION 0.15 PER SIDE.

DIM	MILLIMETERS		INCHES	
	MIN	MAX	MIN	MAX
A	1.35	1.75	0.054	0.068
A1	0.10	0.25	0.004	0.010
A3	0.19	0.25	0.008	0.010
b	0.35	0.49	0.014	0.019
D	8.55	8.75	0.337	0.344
E	3.80	4.00	0.150	0.157
e	1.27 BSC		0.050 BSC	
H	5.80	6.20	0.228	0.244
h	0.25	0.50	0.010	0.019
L	0.40	1.25	0.016	0.049
M	0°	7°	0°	7°

SOLDERING FOOTPRINT*

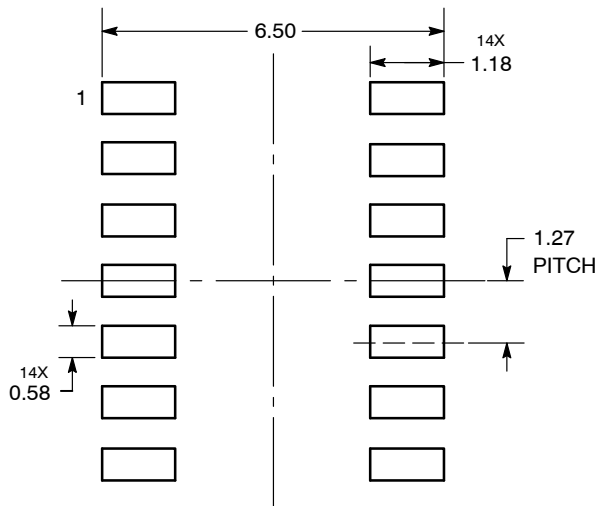

DIMENSIONS: MILLIMETERS

*For additional information on our Pb-Free strategy and soldering details, please download the ON Semiconductor Soldering and Mounting Techniques Reference Manual, SOLDERRM/D.

GENERIC MARKING DIAGRAM*

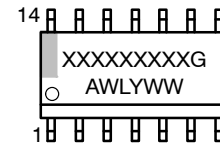

- XXXXXX = Specific Device Code
- A = Assembly Location
- WL = Wafer Lot
- Y = Year
- WW = Work Week
- G = Pb-Free Package

*This information is generic. Please refer to device data sheet for actual part marking. Pb-Free indicator, "G" or microdot "▪", may or may not be present.

STYLES ON PAGE 2

DOCUMENT NUMBER:	98ASB42565B	Electronic versions are uncontrolled except when accessed directly from the Document Repository. Printed versions are uncontrolled except when stamped "CONTROLLED COPY" in red.
DESCRIPTION:	SOIC-14 NB	PAGE 1 OF 2

ON Semiconductor and ON are trademarks of Semiconductor Components Industries, LLC dba ON Semiconductor or its subsidiaries in the United States and/or other countries. ON Semiconductor reserves the right to make changes without further notice to any products herein. ON Semiconductor makes no warranty, representation or guarantee regarding the suitability of its products for any particular purpose, nor does ON Semiconductor assume any liability arising out of the application or use of any product or circuit, and specifically disclaims any and all liability, including without limitation special, consequential or incidental damages. ON Semiconductor does not convey any license under its patent rights nor the rights of others.

SOIC-14
CASE 751A-03
ISSUE L

DATE 03 FEB 2016

STYLE 1:
 PIN 1. COMMON CATHODE
 2. ANODE/CATHODE
 3. ANODE/CATHODE
 4. NO CONNECTION
 5. ANODE/CATHODE
 6. NO CONNECTION
 7. ANODE/CATHODE
 8. ANODE/CATHODE
 9. ANODE/CATHODE
 10. NO CONNECTION
 11. ANODE/CATHODE
 12. ANODE/CATHODE
 13. NO CONNECTION
 14. COMMON ANODE

STYLE 2:
 CANCELLED

STYLE 3:
 PIN 1. NO CONNECTION
 2. ANODE
 3. ANODE
 4. NO CONNECTION
 5. ANODE
 6. NO CONNECTION
 7. ANODE
 8. ANODE
 9. ANODE
 10. NO CONNECTION
 11. ANODE
 12. ANODE
 13. NO CONNECTION
 14. COMMON CATHODE

STYLE 4:
 PIN 1. NO CONNECTION
 2. CATHODE
 3. CATHODE
 4. NO CONNECTION
 5. CATHODE
 6. NO CONNECTION
 7. CATHODE
 8. CATHODE
 9. CATHODE
 10. NO CONNECTION
 11. CATHODE
 12. CATHODE
 13. NO CONNECTION
 14. COMMON ANODE

STYLE 5:
 PIN 1. COMMON CATHODE
 2. ANODE/CATHODE
 3. ANODE/CATHODE
 4. ANODE/CATHODE
 5. ANODE/CATHODE
 6. NO CONNECTION
 7. COMMON ANODE
 8. COMMON CATHODE
 9. ANODE/CATHODE
 10. ANODE/CATHODE
 11. ANODE/CATHODE
 12. ANODE/CATHODE
 13. NO CONNECTION
 14. COMMON ANODE

STYLE 6:
 PIN 1. CATHODE
 2. CATHODE
 3. CATHODE
 4. CATHODE
 5. CATHODE
 6. CATHODE
 7. CATHODE
 8. ANODE
 9. ANODE
 10. ANODE
 11. ANODE
 12. ANODE
 13. ANODE
 14. ANODE

STYLE 7:
 PIN 1. ANODE/CATHODE
 2. COMMON ANODE
 3. COMMON CATHODE
 4. ANODE/CATHODE
 5. ANODE/CATHODE
 6. ANODE/CATHODE
 7. ANODE/CATHODE
 8. ANODE/CATHODE
 9. ANODE/CATHODE
 10. ANODE/CATHODE
 11. COMMON CATHODE
 12. COMMON ANODE
 13. ANODE/CATHODE
 14. ANODE/CATHODE

STYLE 8:
 PIN 1. COMMON CATHODE
 2. ANODE/CATHODE
 3. ANODE/CATHODE
 4. NO CONNECTION
 5. ANODE/CATHODE
 6. ANODE/CATHODE
 7. COMMON ANODE
 8. COMMON ANODE
 9. ANODE/CATHODE
 10. ANODE/CATHODE
 11. NO CONNECTION
 12. ANODE/CATHODE
 13. ANODE/CATHODE
 14. COMMON CATHODE

DOCUMENT NUMBER:	98ASB42565B	Electronic versions are uncontrolled except when accessed directly from the Document Repository. Printed versions are uncontrolled except when stamped "CONTROLLED COPY" in red.
DESCRIPTION:	SOIC-14 NB	PAGE 2 OF 2

ON Semiconductor and  are trademarks of Semiconductor Components Industries, LLC dba ON Semiconductor or its subsidiaries in the United States and/or other countries. ON Semiconductor reserves the right to make changes without further notice to any products herein. ON Semiconductor makes no warranty, representation or guarantee regarding the suitability of its products for any particular purpose, nor does ON Semiconductor assume any liability arising out of the application or use of any product or circuit, and specifically disclaims any and all liability, including without limitation special, consequential or incidental damages. ON Semiconductor does not convey any license under its patent rights nor the rights of others.