

Print Bohrplan Bestückungsseite
PCB-Layout (component side)

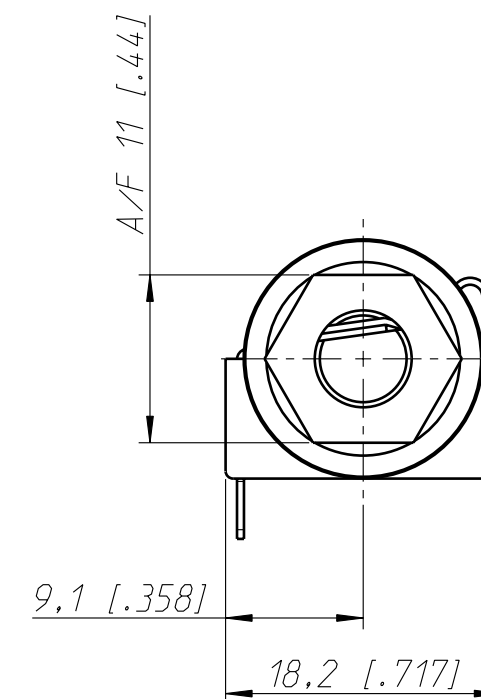

Frontplattenausschnitt (Rückseite)
Panel cut out (rear side)

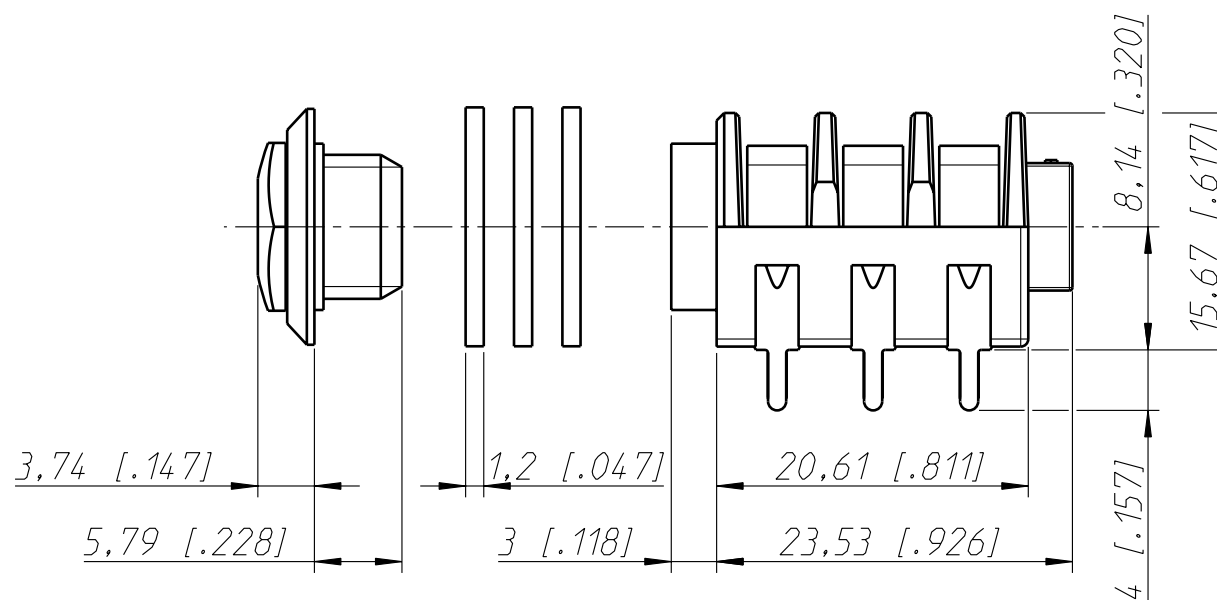
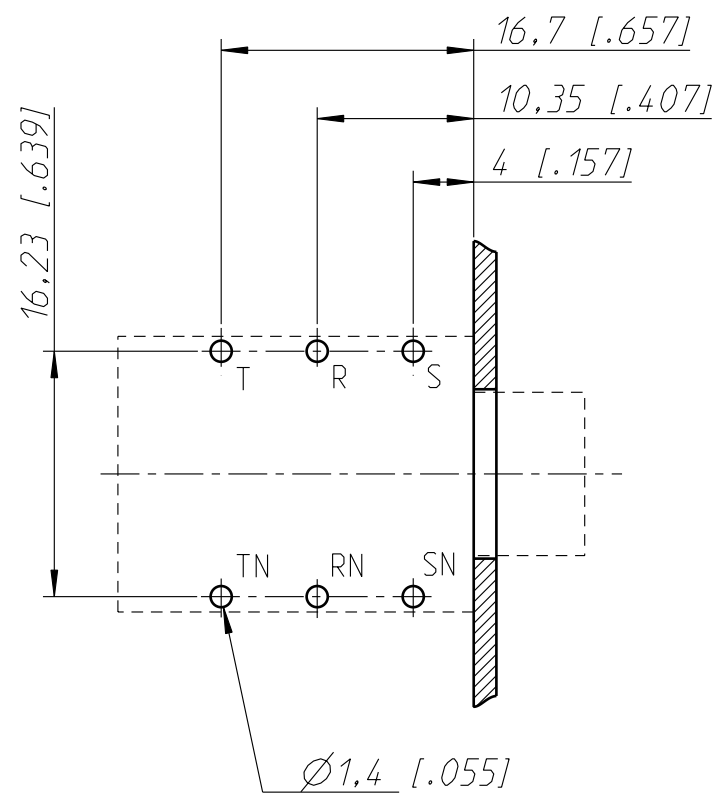
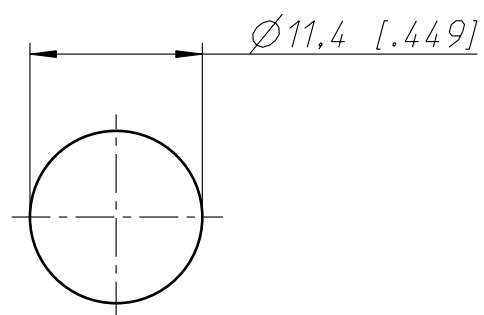

Allgemeintoleranzen ISO 2768-m	Werkstoff Stahl	Massstab: 2:1 (A3)	Gezeichnet	Datum	Name
			Freigegeben	04.02.03	Ender
Zeichnung urheberrechtlich geschützt (DIN 34) (C)	-		Geaendert	-	-
			Aend.-Nr.	-	Aend.-Index -
Benennung M Jack NMJ6HCD2			Ersatz fuer:	Blatt 1 von 1 Bl.	
NEUTRIK AG FL-9494 SCHAAN			Zeichn. Nr.	ST-NMJ6HCD2	