



Welcome to the World of AirBorn Interconnect Solutions

CATALOG PAGES CURRENT AS OF APRIL 2012 FOR MOST CURRENT CATALOG VISIT US AT WWW.AIRBORN.COM OR CLICK THE PAGE REVISION

AirBorn has been manufacturing high reliability interconnect systems for more than 45 years with leading-edge, innovative technology that is more reliable and better-performing than practically all other alternatives.

Our advanced technologies, experienced design support, incomparable lead times and personalized customer service and support provide customers with complete solutions to a vast array of highly specialized design requirements in diverse markets and applications.

You will find in this catalog technical drawings and specification information that will help you solve your interconnection needs from the design stage through production specification.

The products in this catalog are organized by the AirBorn part number assigned to them.

Each connector part number identifies five elements:

- AirBorn Series
- Body
- Size (number of contacts)
- Contact Type
- Hardware Type

Each catalog page shows the choices available for each of these elements. By selecting one option from any category on the page, you can build a set of connectors to meet your requirements.

If you do not find a particular connector size or option, please contact AirBorn for further assistance. AirBorn can manufacture special configurations for your exact specifications.

When everything matters, go AirBorn.

www.AirBorn.com

AirBorn International LTD

Mercury House, Station Road
Edenbridge. Kent. TN8 6HL
United Kingdom

Phone: +44 (0)1732 864930
E-mail: cs@airbo_int.com

AirBorn

4321 AirBorn Drive
Addison, TX 75001-0519
United States

Phone: (972) 931-3200
Fax: (972) 931-9305
E-mail: info@airborn.com

AirBorn

3500 AirBorn Circle
Georgetown, TX 78626
United States

Phone: (512) 863-5585
Fax: (512) 863-8259
E-mail: info@airborn.com

"N" SERIES - .025"

Nano Connectors
Cable to Cable
One Row

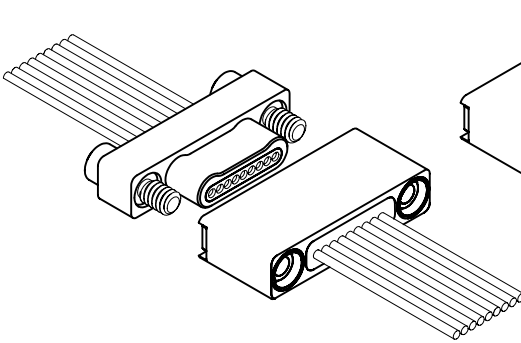

Cable to Cable
Sizes: 9 thru 51
Page: N-9

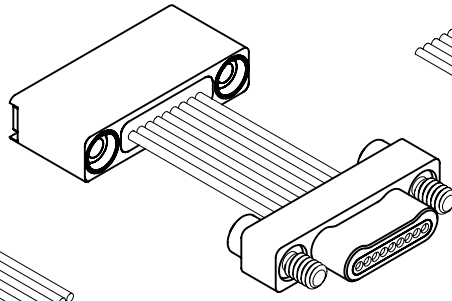

Cable to Cable, Jumpers
Sizes: 9 thru 51
Page: N-11

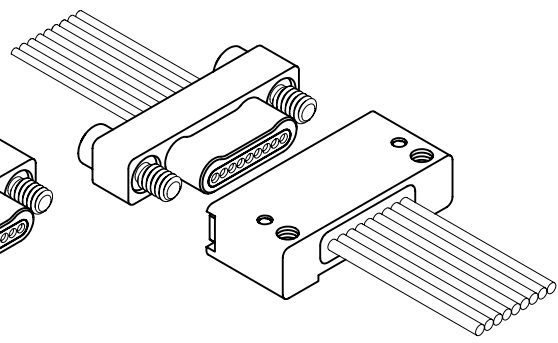

Cable to Cable, with Mounting Holes
Sizes: 9 thru 51
Page: N-13 & N-15

Nano Connectors
Board to Cable
One Row

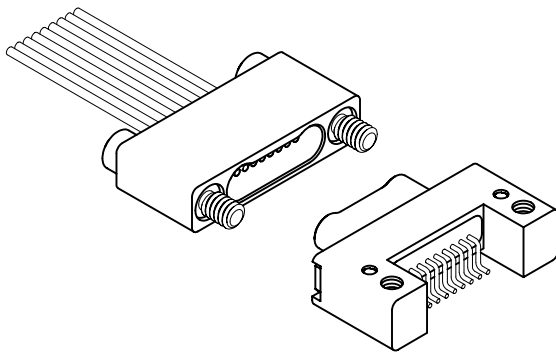

Cable to Horizontal SMT
Sizes: 9 thru 51
Page: N-17 & N-19

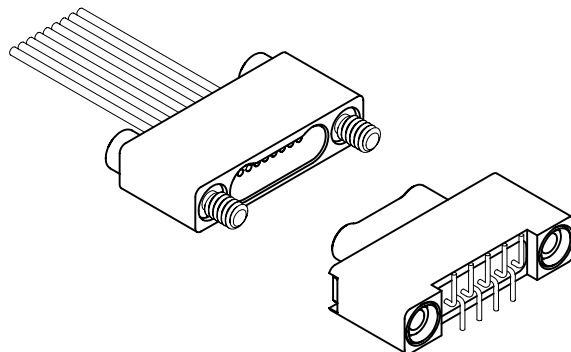

Cable to Vertical SMT
Sizes: 9 thru 51
Page: N-23 & N-25

Nano Connectors
Board to Cable
One Row

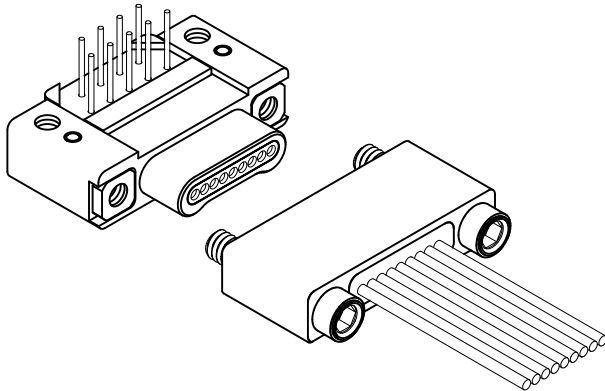

Cable to Right Angle PTH
Sizes: 9 thru 51
Page: N-29 & N-31

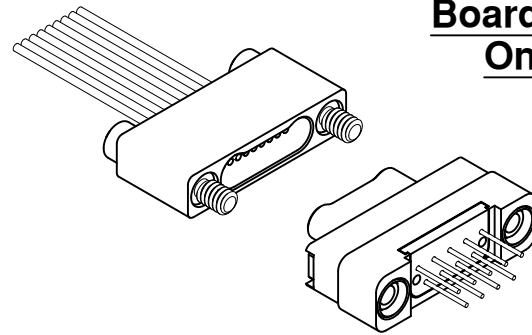

Cable to Vertical PTH
Sizes: 9 thru 51
Page: N-35 & N-37

Nano Connectors
Cable to Cable
Two Row

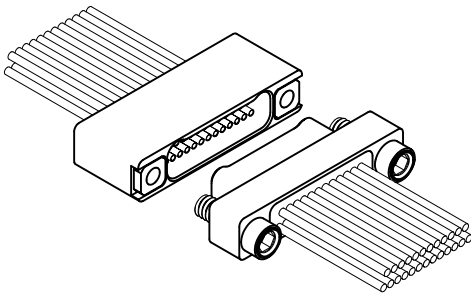

Cable to Cable
Sizes: 9 thru 91
Page: N-41

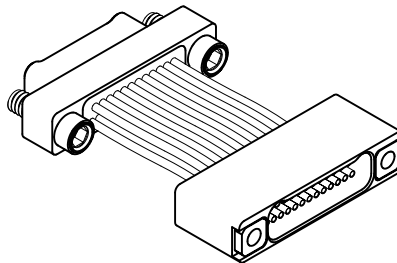

Cable to Cable, Jumpers
Sizes: 9 thru 85
Page: N-43

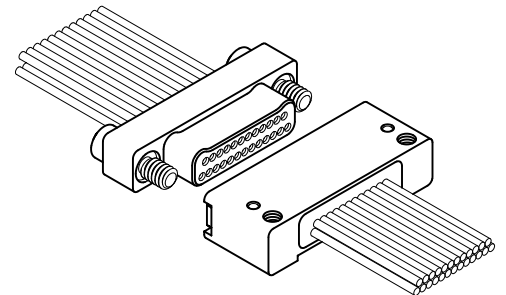

Cable to Cable, with Mounting Holes
Sizes: 9 thru 85
Page: N-45 & N-47

Nano Connectors
Rear Panel Mount
Two Row

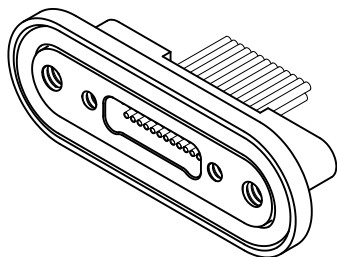

I/O
Sizes: 9 thru 85
Page: N-98.3

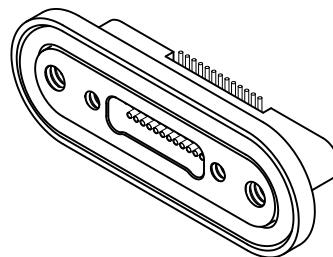

Vertical SMT
Sizes: 9 thru 85
Page: N-98.4

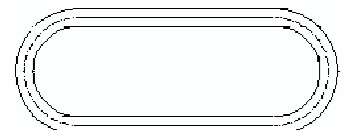

REPLACEMENT O-RINGS
PAGE: N 8.3

Nano Connectors
Board to Cable
Two Row

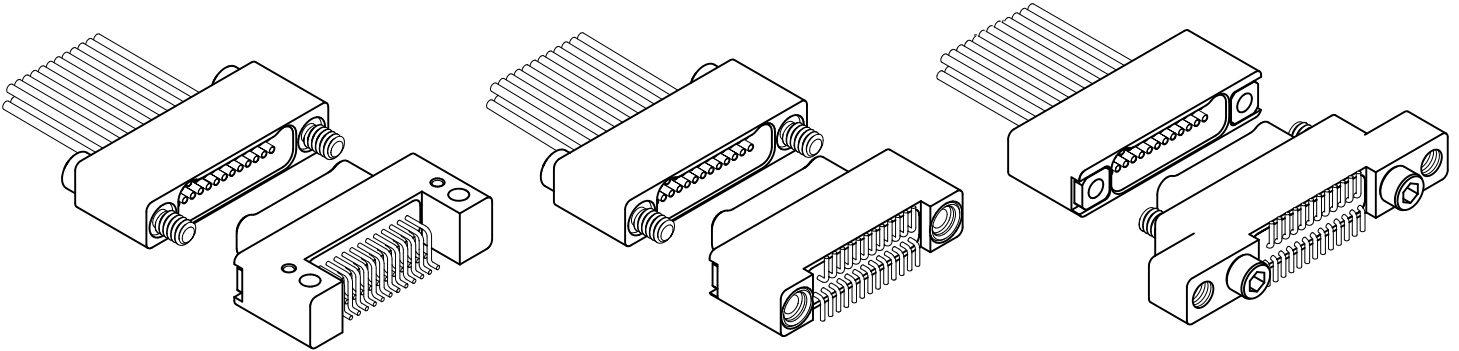

Cable to Horizontal SMT
 Sizes: 9 thru 85
 Page: N-49 & N-51

Cable to Vertical SMT
 Sizes: 9 thru 91
 Page: N-55 & N-57

**Cable to Vertical SMT
 with Mounting Holes**
 Sizes: 9 thru 69
 Page: N-61 & N-63

Nano Connectors
Board to Cable
Two Row

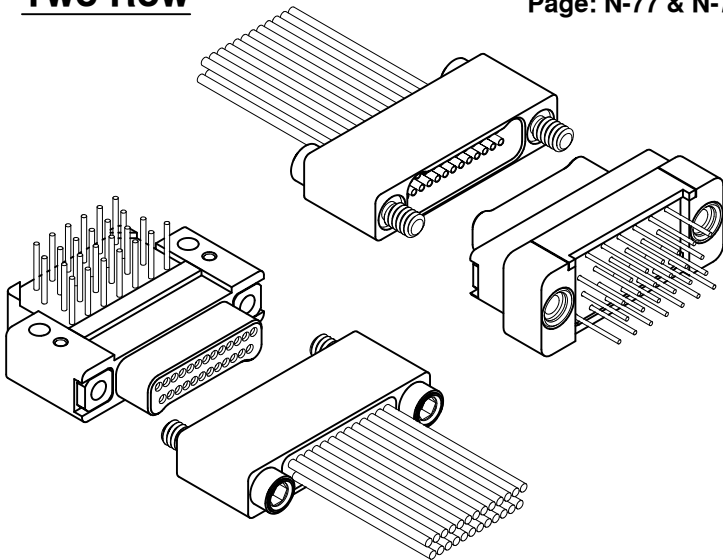

Cable to Right Angle PTH
 Sizes: 9 thru 91
 Page: N-69 & N-71

Cable to Vertical PTH
 Sizes: 9 thru 85
 Page: N-77 & N-79

Nano Connectors
Shorting Connectors

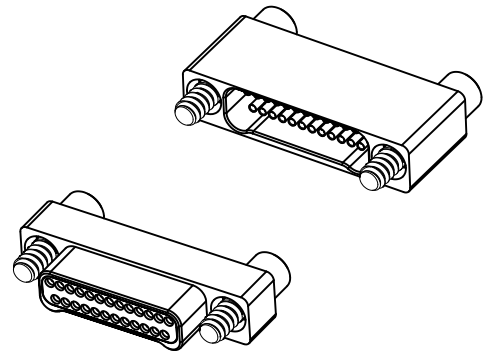

Shorting Connectors
 Sizes: 9 thru 85
 Page: NA-8.1 & NA-8.2

Nano Connectors
Flex to Board
One & Two Row

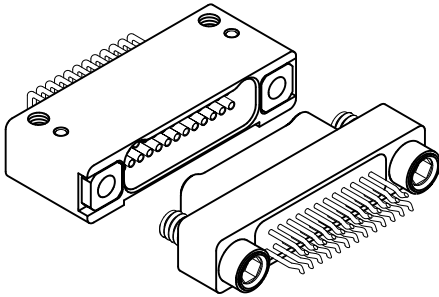

Straddle Mount Flex
Sizes: 9 thru 85
Page: N-85 & N-87

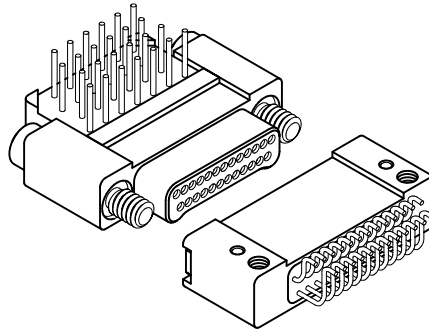

Right Angle Flex Mount
Sizes: 9 thru 85
Page: N-93

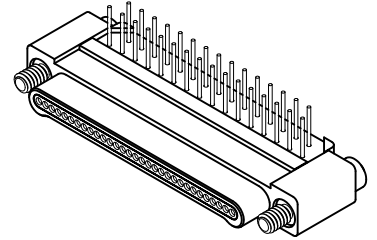

Right Angle Flex Mount
Sizes: 9 thru 51
Page: N-40.1

Nano Connectors
Splashproof
Two Row

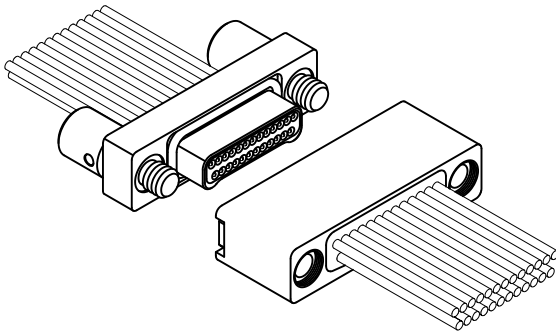

Cable to Cable, Splashproof
Sizes: 9 thru 85
Page: N-97

Nano Circular
Connectors

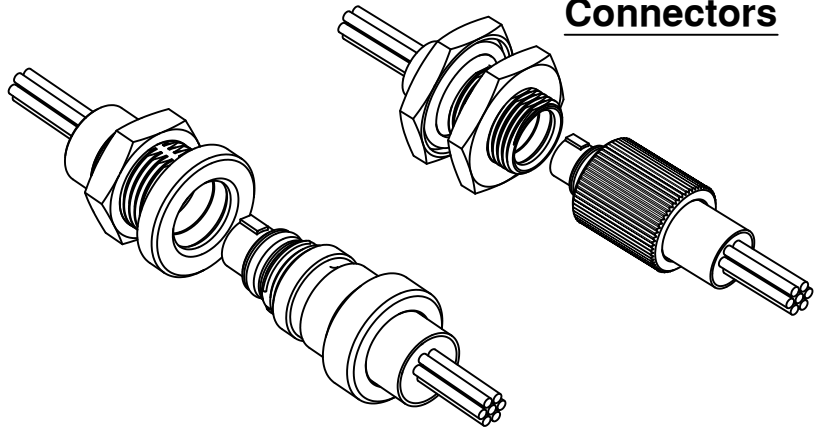

Quick Release
Sizes: 7 & 19
Page: N-101

Threaded Coupling
Sizes: 7 & 19
Page: N-103

Nano Backshells
One & Two Row

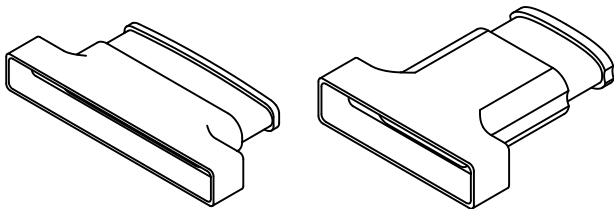

One & Two Row Backshells
Sizes: 9 thru 51 (one row)
9 thru 91 (two row)
Page: NA-3

Nano Dust Covers

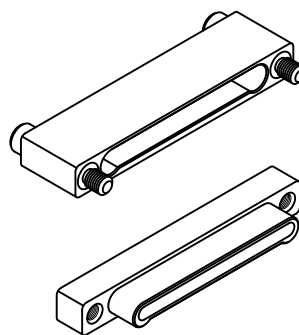

One Row Dust Covers
Sizes: 9 thru 51
Page: NA-5

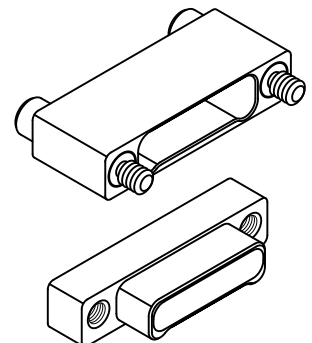

Two Row Dust Covers
Sizes: 9 thru 85
Page: NA-7

Contents

"N" Series

.025" Nanominiature PCB and I/O Connectors

N-1	Index
N-5	Contents
N-6	Specifications
N-7	Performance
N-8	Part number description
One Row - Cable to Cable Connectors	
N-9	NM, NM Cable to Cable
N-11	NM, NM Cable to Cable, Jumper Assembly
N-13, 15	NM, NM Cable to Cable, Mounting Holes
One Row - Cable to Board Connectors	
N-17, 19	NM, NK Cable to Horizontal SMT
N-21	NK Board layouts - Horizontal SMT
N-23, 25	NM, NK Cable to Vertical SMT
N-27	NK Board layouts - Vertical SMT
N-29, 31	NM, NK Cable to Right Angle PTH
N-33	NK Board layouts - Right Angle PTH
N-35, 37	NM, NK Cable to Vertical PTH
N-39	NK Board layouts - Vertical PTH
N-40.1	NK Right Angle Flex Mount
Two Row - Cable to Cable Connectors	
N-41	NM, NM Cable to Cable
N-43	NM, NM Cable to Cable, Jumper Assembly
N-45, 47	NM, NM Cable to Cable, Mounting Holes
Two Row - Cable to Board Connectors	
N-49, 51	NM, NK Cable to Horizontal SMT
N-53	NK Board layouts - Horizontal SMT
N-55, 57	NM, NK Cable to Vertical SMT
N-59	NK Board layouts - Vertical SMT
N-61, 63	NM, NK Cable to Vertical SMT with Mounting Holes
N-65	NK Board layouts - Vertical SMT with Mounting Holes
N-69, 71	NM, NK Cable to Right Angle PTH
N-73	NK Board layouts - Right Angle PTH
N-77	NK Cable to Vertical PTH with Fixed Hardware: Board Layouts
N-84.1	NK Cable to Vertical PTH with Turning Hardware: Board Layouts
N-84.9	NK Cable to Vertical PTH with Turning Hardware and Mounting Ears: Board Layouts
Two Row - Flex to Board Connectors	
N-85, 87	NM, NK Straddle Mount Flex
N-89	NM Board layouts - Straddle Mount
N-93	NK, NK Right Angle Flex Mount
N-95	NK Board layouts - Right Angle
Two Row - Splashproof Connectors	
N-97	NMSP Splashproof Cable to Cable

Two Row - Rear Panel Mount Connectors

N-98.1	Specifications
N-98.2	Performance
N-98.3	NMRP I/O Connector
N-98.4	NKRP Vertical Surface Mount
N-98.5	NMRP Horizontal Surface Mount
N-98.6	NKRP Straddle Mount
N-98.62	NKRP Board layouts
N-98.64	NKRP Panel cutouts

Circular Connectors

N-99	Specifications
N-100	Performance
N-101	NC Quick Release
N-103	NC Threaded Coupling
N-105	NC Panel Mounting Dimensions

Accessories

NA-2	Wire codes (30 awg, 32 awg)
NA-3	2 Row Backshells
NA-4	1 Row Backshells
NA-5	1 Row Dust Covers
NA-7	2 Row Dust Covers
NA-8.1	Shorting Connectors
NA-9	Military Cross Reference

Specifications

Materials and Finishes *

Contacts:	Pins: BeCu alloy strip per ASTM-B-194 Sockets: BeCu per ASTM-B-194 or NiAg per ASTM-B-122
Embedment:	Insulating compound per MIL-I-16923
Contact Finish:	Gold plate per ASTM B 488, SAE AMS 2422
Molded Insulators:	Glass filled liquid crystal polymer (LCP) per ASTM D5138 or MIL-M-24519
Shell:	Aluminum 6061-T6 per SAE AMS-QQ-A-250/11 or 6061-T6511 per SAE AMS-QQ-A-200/8 - OR - 303 Stainless Steel per ASTM A581/A581M or ASTM A582/A582M Passivated per SAE AMS-2700 - OR - Titanium per SAE-AMS-T-9046 Passivated per ASTM-B-600
Aluminum Shell Finishes:	Electroless Nickel per SAE AMS-C-26074 -OR- Electrodeposited Cadmium per SAE AMS-QQ-P-416
Hardware:	Corrosion resistant steel per ASTM A581/A581M or ASTM A582/A582M Passivated per SAE AMS-2700
Tolerances:	Unless otherwise specified: Decimals = .XXX = ± 0.005 " .XXXX = ± 0.0050 " Angles = $\pm 2^\circ$

Note: AirBorn can manufacture special configurations for your exact specifications.

* = Reference the above listed specifications or an equivalent industry standard when applicable



Performance Reference M32139

AirBorn "N" Series meets or exceeds M32139 Performance Specifications

Contact Rating:	1-amperes maximum
Solderability:	Terminals (except crimp) tested in accordance with MIL-STD-202, Method 208
Wire Size:	Stranded #30 & #32 AWG or solid #30 AWG standard (consult factory for other sizes and types)
Test Voltage:	250 V, RMS, 60 Hz
Operating Temperature:	-55° C to +125° C
Insulation Resistance:	5,000 megohms minimum @ 100 VDC
Durability:	200 connector mating cycles tested in accordance with EIA-364-09
Vibration:	Tested in accordance with EIA-364-28, Condition IV
Shock:	Tested in accordance with EIA-364-27, Condition G
Salt Spray:	Mated connectors tested in accordance with EIA-364-26, Condition B
Humidity:	Mated connectors tested in accordance with EIA-364-31, Condition A (except steps 7a and 7b)
Thermal Shock:	Tested to the temperature extremes of EIA-364-32, Condition I
Contact Resistance:	0.021 volt maximum drop @ 1.0 amps (.021 ohms)
Contact Engaging Force:	5.0 ounce maximum, with minimum diameter test sleeve
Contact Separating Force:	0.4 ounce minimum, with maximum diameter test sleeve

Part Number Description

Each connector part number consists of at least five elements: series, body description, size (number of contacts), type of contacts, and type of hardware. A sixth element is added whenever special modifications or options are available.

Each catalog page shows the choices available for each of these elements. By selecting one option from each category on the page, you can build a set of connectors to meet your requirements.

Each element is identified by a combination of letters and/or numbers in fixed field lengths, and separated by a hyphen (-). Each space must be filled in to complete the number. When the size, for example, is less than 100, indicate as 009, 051, etc.

Series:

This will always be a two letter designator, and will identify the connector series. All .025" connectors begin with the letter "N". The second letter designates the various styles of .025" connectors.

Body:

Each digit of the Body Designator will normally identify (1) the number of rows, (2) the style of body, and (3) the body materials. The three digit number to identify the body consists of one digit from each group.

Size:

The size is determined by the number of contacts in the connector, and is an integral part of the part number. Order only sizes shown on the catalog page unless otherwise noted.

Contacts:

Each page also identifies all contact options for a given connector. Mating contacts are shown on the page opposite from the description. The first two digits designate the type of contacts and terminations; the third digit designates the plating option.

Hardware:

The hardware designator is four digits; two for style of hardware and two for polarization or wiring instruction. Follow the choices for each connector.

Special Instructions (Options):

Special instructions are referenced by a three digit number added to the end of the part number. The last three digits are included only when applicable. AirBorn, Inc. will provide individual code numbers as needed.

Note:

Each page is as comprehensive as possible. However, if you do not find a particular connector size or option, please contact the factory for further assistance.

Symbolizes options that are not ROHS compliant.

1 · ROW

Cable to Cable

.025"

NM, NM

9 thru 51 Contacts

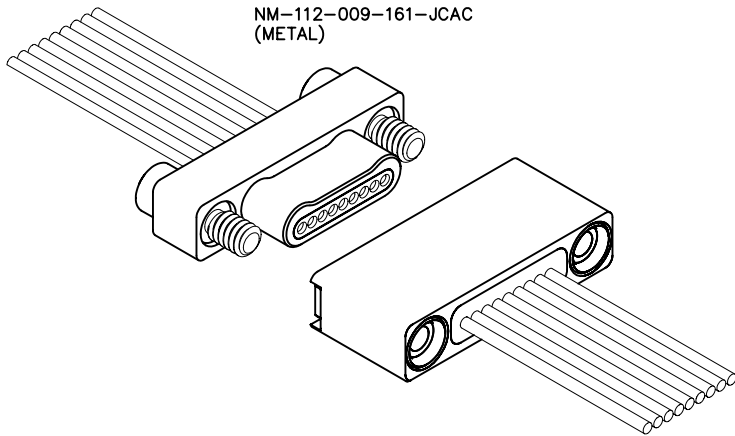

NM-112-009-161-JCAC
(METAL)

NM-122-009-261-THAC
(METAL)

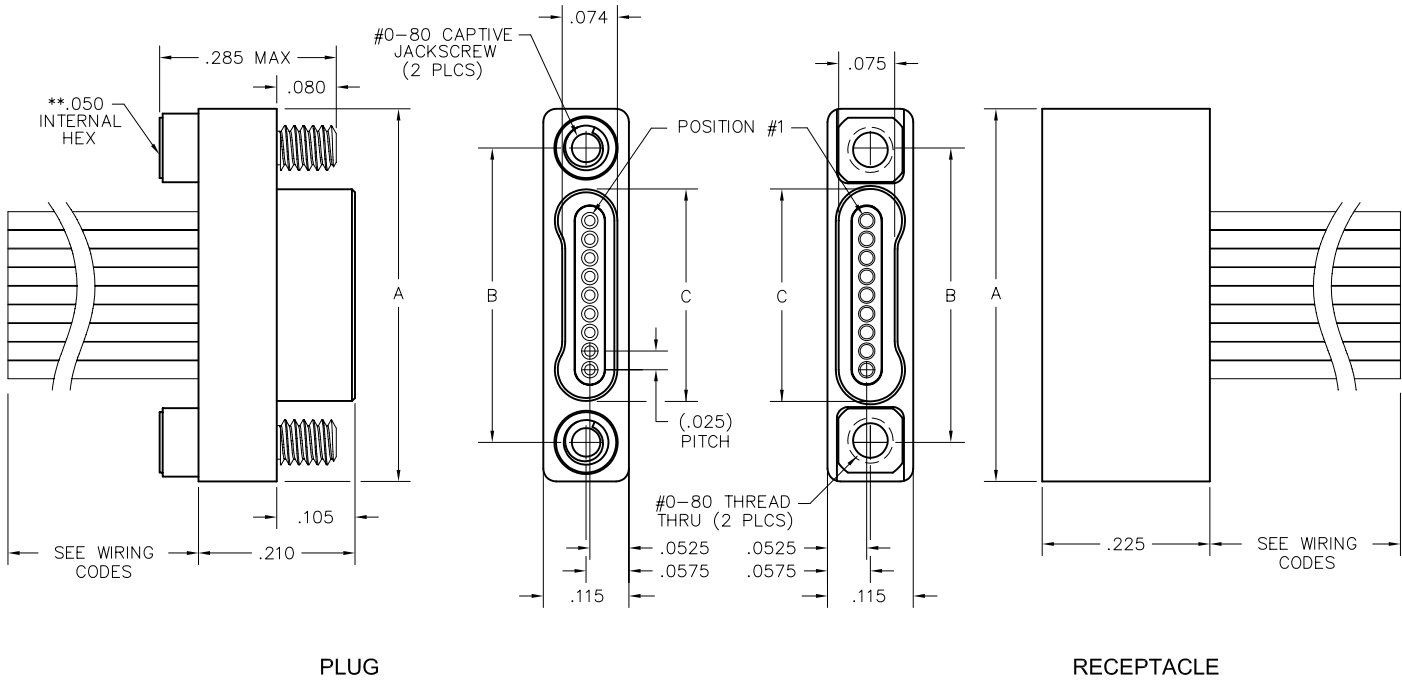

PLUG

RECEPTACLE

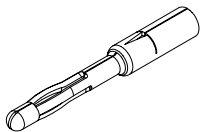

PIN CONTACT
3 TINE SPRING MEMBER, CRIMP

SIZE	A	B	DIMENSIONS	
			PLUG	RCPT
9	.500	.395	.284	.285
15	.650	.545	.434	.435
21	.800	.695	.584	.585
25	.900	.795	.684	.685
31	1.050	.945	.834	.835
37	1.200	1.095	.984	.985
51	1.550	1.445	1.334	1.335

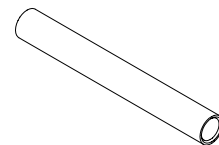

SOCKET CONTACT
DRAWN TUBE, CRIMP

** = HEX MEASUREMENT TAKEN ACROSS THE FLATS.

PLUG: NM-112 -009 - 161 -JCAC
RECEPTACLE: NM-122 -009 - 261 -THAC
 XX-XXX-XXX-XXX-XXXX

PLUG		RECEPTACLE	
SERIES			
NM .025" Metal I/O Connector		NM .025" Metal I/O Connector	
BODY			
1 1-Row		1 1-Row	
BODY STYLE:		BODY STYLE:	
1 Plug, straight		2 Receptacle, straight	
5 Plug, straight with factory installed backshell (See page NA-4)		6 Receptacle, straight with factory installed backshell (See page NA-4)	
BODY MATERIAL:		BODY MATERIAL:	
2 Liquid Crystal Polymer w/ electroless nickel shell		2 Liquid Crystal Polymer w/ electroless nickel shell	
3 Liquid Crystal Polymer w/ electrodeposited cadmium shell <input checked="" type="checkbox"/>		3 Liquid Crystal Polymer w/ electrodeposited cadmium shell <input checked="" type="checkbox"/>	
4 Liquid Crystal Polymer w/ stainless steel shell ***		4 Liquid Crystal Polymer w/ stainless steel shell ***	
5 Liquid Crystal Polymer w/ titanium shell ***		5 Liquid Crystal Polymer w/ titanium shell ***	
SIZE			
XXX Number of contacts (009, 015, 021, 025, 031, 037 or 051)		XXX Number of contacts (009, 015, 021, 025, 031, 037 or 051)	
CONTACTS			
TYPE CONTACTS/TERMINATIONS:		TYPE CONTACTS/TERMINATIONS:	
16 Pin, straight, crimped wire		26 Socket, straight, crimped wire	
PLATING OPTIONS:		PLATING OPTIONS:	
1 50 u" Au contacts		1 50 u" Au contacts	
HARDWARE			
STYLE OF HARDWARE:		STYLE OF HARDWARE:	
00 None ***		00 None ***	
JC Turning jackscrews, captivated #0-80 UNF*		JC Turning jackscrews, captivated #0-80 UNF* (body material 2 and 3 only)	
TH Threaded hole**, #0-80 UNF (body material 2 and 3 only)		TH Threaded hole**, #0-80 UNF	
WIRING OPTIONS:		WIRING OPTIONS:	
XX See wiring codes, Page NA-3.10		XX See wiring codes, Page NA-3.10	

* = Recommended torque value 1.0 inch-lbs. max.
 Ball end hex wrench not recommended
 Hex wrench key/bit conforming to the requirements of ASME / ANSI-B-18.3 is recommended.
 .050" hex L-key long arm wrench - order AirBorn p/n CDG14148.

** = Threaded hole tapped directly into stainless steel and titanium shells, aluminum shells have stainless steel inserts (as shown on previous page).

*** = Not available option if specifying factory installed backshell.

= Option not RoHS compliant

1 • ROW Cable to Cable (Jumper Assembly)

.025"

NM, NM

9 thru 51 Contacts

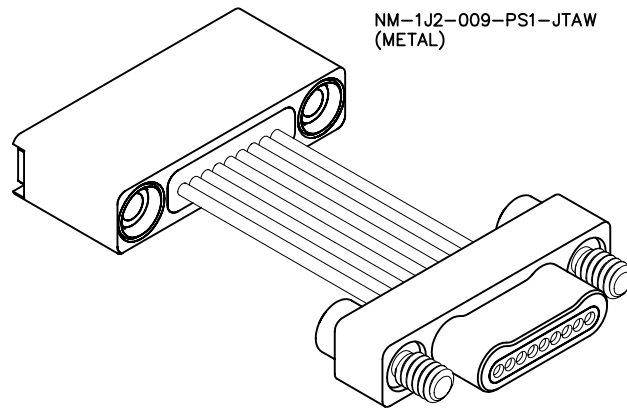

NM-1J2-009-PS1-JTAW
(METAL)

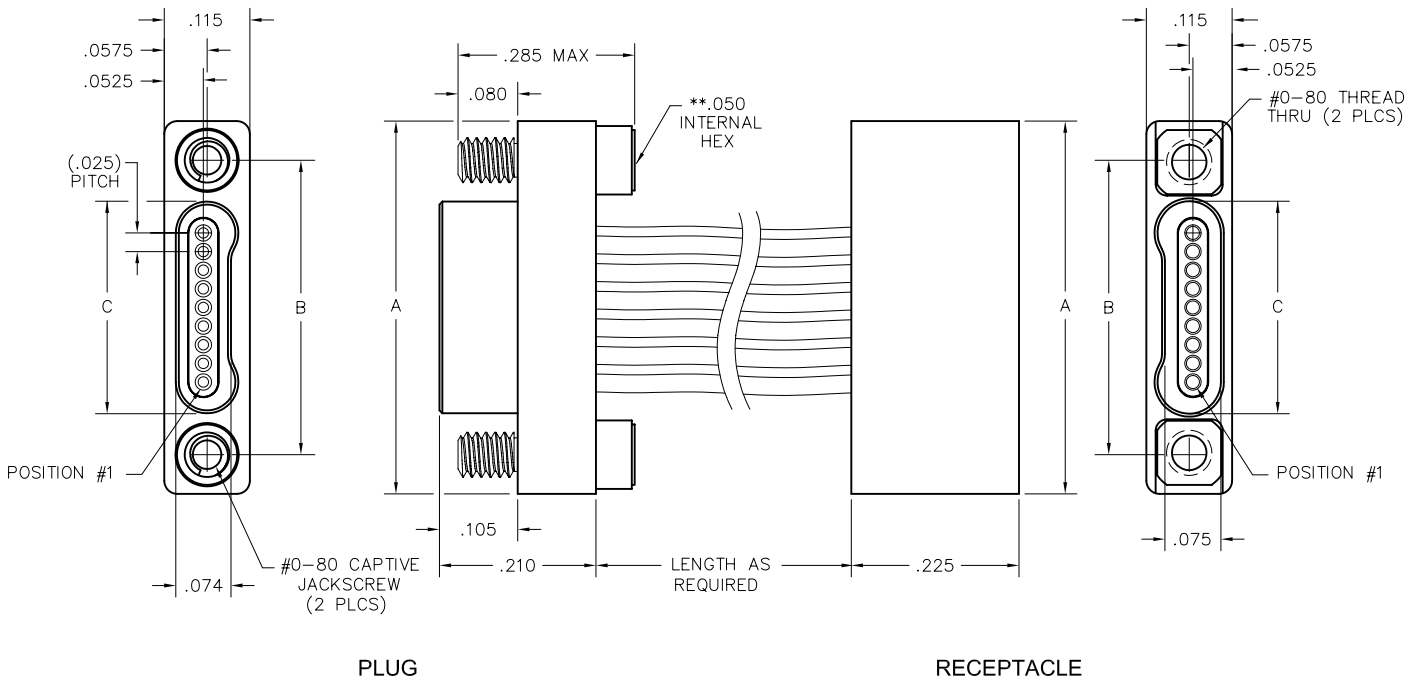

PLUG

RECEPTACLE

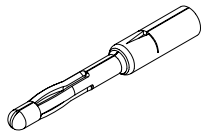

PIN CONTACT
3 TINE SPRING MEMBER, CRIMP

SIZE	DIMENSIONS			
	A	B	C	
			PLUG	RCPT
9	.500	.395	.284	.285
15	.650	.545	.434	.435
21	.800	.695	.584	.585
25	.900	.795	.684	.685
31	1.050	.945	.834	.835
37	1.200	1.095	.984	.985
51	1.550	1.445	1.334	1.335

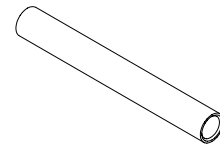

SOCKET CONTACT
DRAWN TUBE, CRIMP

** = HEX MEASUREMENT TAKEN ACROSS THE FLATS.

NM-1J2-009-PS1-JTAW
 XX-XXX-XXX-XXX-XXXX

SERIES	
NM .025" Metal I/O Connector	
BODY	
1	1-Row
BODY STYLE:	
J	Jumper assembly
BODY MATERIAL:	
2	Liquid Crystal Polymer with electroless nickel shell
3	Liquid Crystal Polymer with electrodeposited cadmium shell <input checked="" type="checkbox"/>
4	Liquid Crystal Polymer with stainless steel shell
5	Liquid Crystal Polymer with titanium shell
SIZE	
XXX Number of contacts (009, 015, 021, 025, 031, 037 or 051)	
CONTACTS	
TYPE CONTACTS/TERMINATIONS:	
PP	Plug to plug
PS	Plug to receptacle
SS	Receptacle to receptacle
PLATING OPTIONS:	
1	50 µ" Au contacts
HARDWARE	
STYLE OF HARDWARE:	
00	None
JJ	Four #0-80 UNF* turning jackscrews, captivated, two on each connector***
JT	Two #0-80 UNF* turning jackscrews, captivated, on plug & two #0-80 UNF threaded holes** on receptacle
JP	Two #0-80 UNF* turning jackscrews, captivated, on plug & two #0-80 UNF threaded holes** on plug***
TJ	Two #0-80 UNF threaded holes** on plug & two #0-80 UNF* turning jackscrews, captivated, on receptacle***
JR	Two #0-80 UNF* turning jackscrews, captivated, on receptacle & two #0-80 UNF threaded holes** on receptacle***
TT	Four #0-80 UNF threaded holes**, two on each connector***
POLARIZATION / WIRING:	
XX	For wiring codes, see page NA-2

* = Recommended torque value 1.0 inch-lbs. max.

Ball end hex wrench not recommended

Hex wrench key/bit conforming to the requirements of ASME / ANSI-B-18.3 is recommended.

.050" hex L-key long arm wrench - order AirBorn p/n CDG14148.

** = Threaded hole tapped directly into stainless steel and titanium shells, aluminum shells have stainless steel inserts (as shown on previous page).

*** = Body material 2 and 3 only

● Consult factory if jumpers require other than direct one to one connections.

= Option not RoHS compliant

1 · ROW Cable to Cable

.025"

NM, NM

9 thru 51 Contacts

NM-112-009-161-JCAC
(METAL)

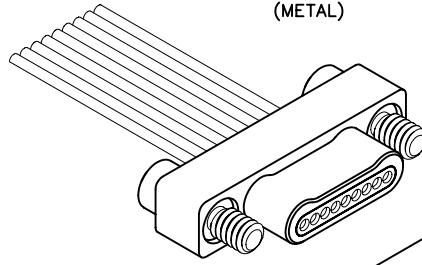

NM-142-009-261-THAC
(METAL)

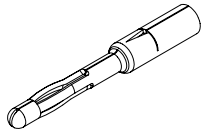
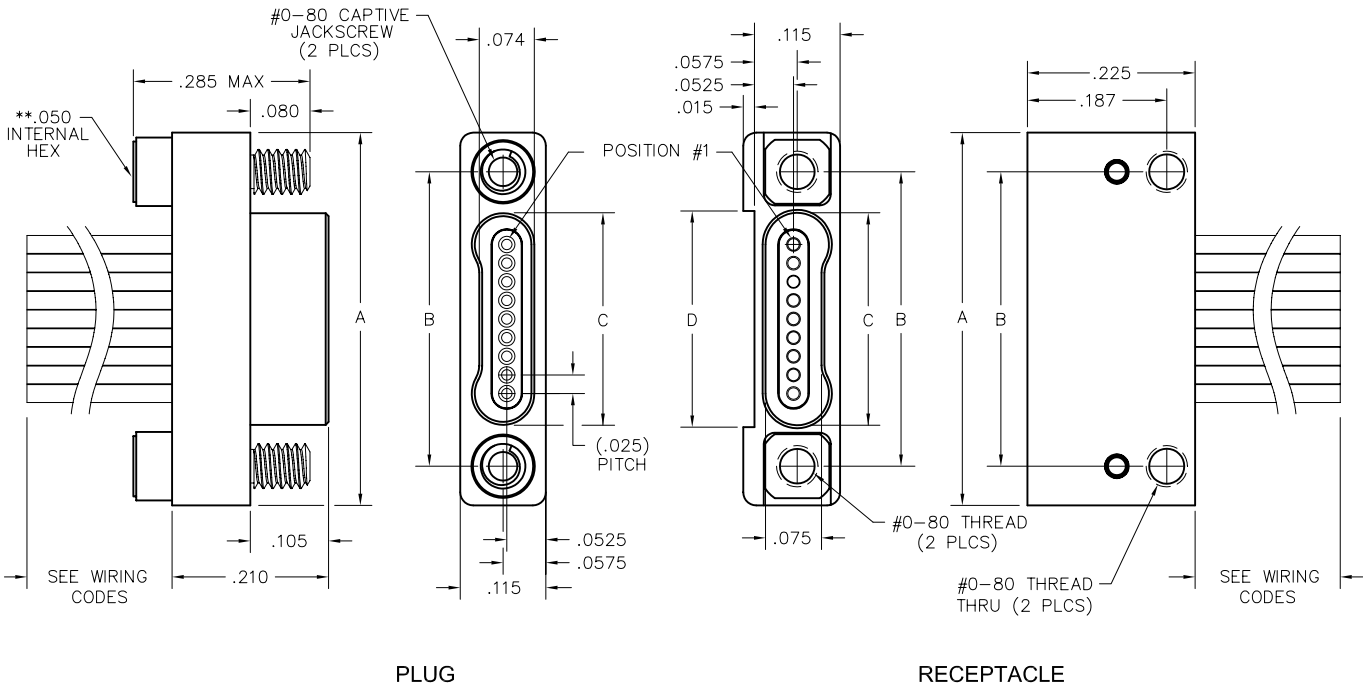
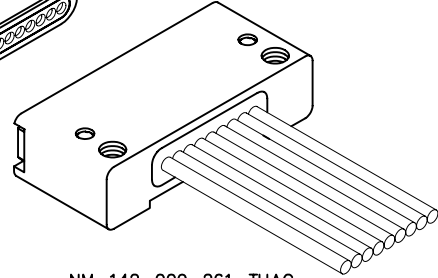

PIN CONTACT
3 TINE SPRING MEMBER, CRIMP

SIZE	A	B	DIMENSIONS		D
			PLUG	RCPT	
9	.500	.395	.284	.285	.290
15	.650	.545	.434	.435	.440
21	.800	.695	.584	.585	.590
25	.900	.795	.684	.685	.690
31	1.050	.945	.834	.835	.840
37	1.200	1.095	.984	.985	.990
51	1.550	1.445	1.334	1.335	1.340

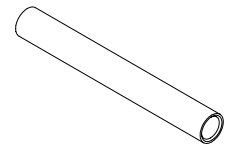

SOCKET CONTACT
DRAWN TUBE, CRIMP

** = HEX MEASUREMENT TAKEN ACROSS THE FLATS.

PLUG: NM-112 -009 -161 -JCAC
RECEPTACLE: NM-142 -009 -261 -THAC
 XX-XXX-XXX-XXX-XXXX

PLUG		RECEPTACLE	
SERIES			
NM .025" Metal I/O Connector		NM .025" Metal I/O Connector	
BODY			
1	1-Row	1	1-Row
BODY STYLE:		BODY STYLE:	
1	Plug, straight	4	Receptacle, straight with mounting holes
BODY MATERIAL:		BODY MATERIAL:	
2	Liquid Crystal Polymer w/ electroless nickel shell	2	Liquid Crystal Polymer w/ electroless nickel shell
3	Liquid Crystal Polymer w/ electrodeposited cadmium shell <input checked="" type="checkbox"/>	3	Liquid Crystal Polymer w/ electrodeposited cadmium shell <input checked="" type="checkbox"/>
SIZE			
XXX Number of contacts (009, 015, 021, 025, 031, 037 or 051)		XXX Number of contacts (009, 015, 021, 025, 031, 037 or 051)	
CONTACTS			
TYPE CONTACTS/TERMINATIONS:		TYPE CONTACTS/TERMINATIONS:	
16	Pin, straight, crimped wire	26	Socket, straight, crimped wire
PLATING OPTIONS:		PLATING OPTIONS:	
1	50 u" Au contacts	1	50 u" Au contacts
HARDWARE			
STYLE OF HARDWARE:		STYLE OF HARDWARE:	
JC	Turning jackscrews, captivated #0-80 UNF*	TH	Threaded hole, #0-80 UNF
WIRING OPTIONS:		WIRING OPTIONS:	
XX	See wiring codes, Page NA-2	XX	See wiring codes, Page NA-2

* = Recommended torque value 1.0 inch-lbs. max.
 Ball end hex wrench not recommended
 Hex wrench key/bit conforming to the requirements of ASME / ANSI-B-18.3 is recommended.
 .050" hex L-key long arm wrench - order AirBorn p/n CDG14148.

= Option not ROHS compliant

1 · ROW Cable to Cable

.025"

NM, NM

9 thru 51 Contacts

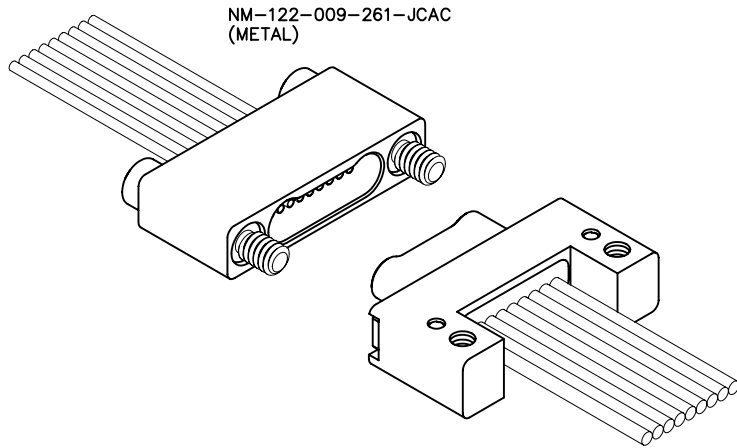

NM-132-009-161-THAC
(METAL)

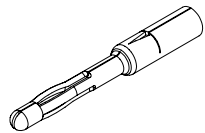
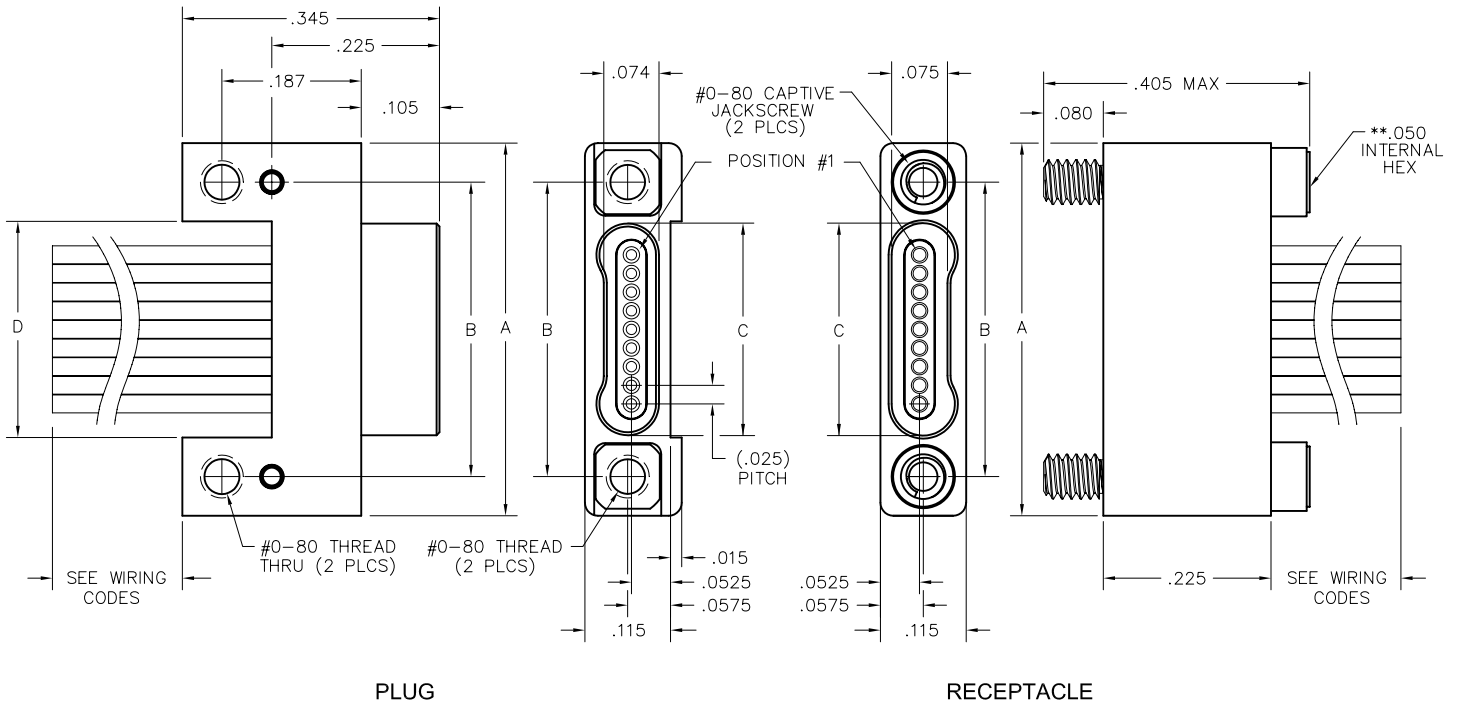

PIN CONTACT
3 TINE SPRING MEMBER, CRIMP

SIZE	A	B	DIMENSIONS		D
			PLUG	RCPT	
9	.500	.395	.284	.285	.290
15	.650	.545	.434	.435	.440
21	.800	.695	.584	.585	.590
25	.900	.795	.684	.685	.690
31	1.050	.945	.834	.835	.840
37	1.200	1.095	.984	.985	.990
51	1.550	1.445	1.334	1.335	1.340

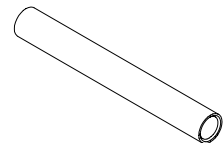

SOCKET CONTACT
DRAWN TUBE, CRIMP

** = HEX MEASUREMENT TAKEN ACROSS THE FLATS.

PLUG: NM-132-009-161-THAC
RECEPTACLE: NM-122-009-261-JCAC
 XX-XXX-XXX-XXX-XXXX

PLUG		RECEPTACLE	
SERIES			
NM .025" Metal I/O Connector		NM .025" Metal I/O Connector	
BODY			
1	1-Row	1	1-Row
BODY STYLE:		BODY STYLE:	
3	Plug, straight with mounting holes	2	Receptacle, straight
BODY MATERIAL:		BODY MATERIAL:	
2	Liquid Crystal Polymer w/ electroless nickel shell	2	Liquid Crystal Polymer w/ electroless nickel shell
3	Liquid Crystal Polymer w/ electrodeposited cadmium shell <input checked="" type="checkbox"/>	3	Liquid Crystal Polymer w/ electrodeposited cadmium shell <input checked="" type="checkbox"/>
SIZE			
XXX Number of contacts (009, 015, 021, 025, 031, 037 or 051)		XXX Number of contacts (009, 015, 021, 025, 031, 037 or 051)	
CONTACTS			
TYPE CONTACTS/TERMINATIONS:		TYPE CONTACTS/TERMINATIONS:	
16	Pin, straight, crimped wire	26	Socket, straight, crimped wire
PLATING OPTIONS:		PLATING OPTIONS:	
1	50 u" Au contacts	1	50 u" Au contacts
HARDWARE			
STYLE OF HARDWARE:		STYLE OF HARDWARE:	
TH	Threaded hole, #0-80 UNF	JC	Turning jackscrews, captivated #0-80 UNF*
WIRING OPTIONS:		WIRING OPTIONS:	
XX	See wiring codes, Page NA-2	XX	See wiring codes, Page NA-2

* = Recommended torque value 1.0 inch-lbs. max.
 Ball end hex wrench not recommended
 Hex wrench key/bit conforming to the requirements of ASME / ANSI-B-18.3 is recommended.
 .050" hex L-key long arm wrench - order AirBorn p/n CDG14148.

= Option not ROHS compliant

1 · ROW Cable to Board Horizontal SMT

.025"

NM, NK

9 thru 51 Contacts

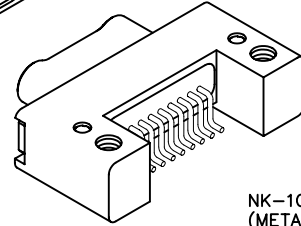
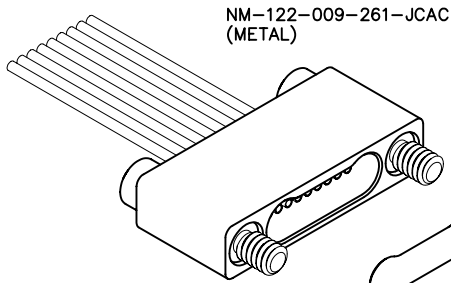

NK-1C2-009-125-TH00
(METAL)

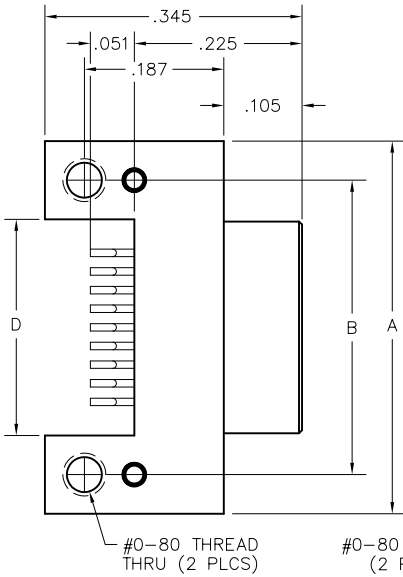

PLUG

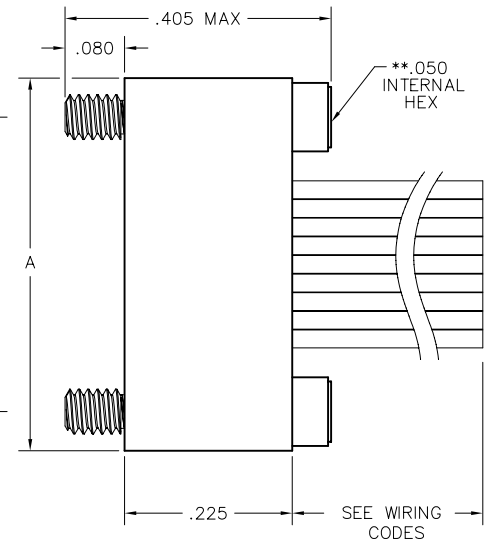
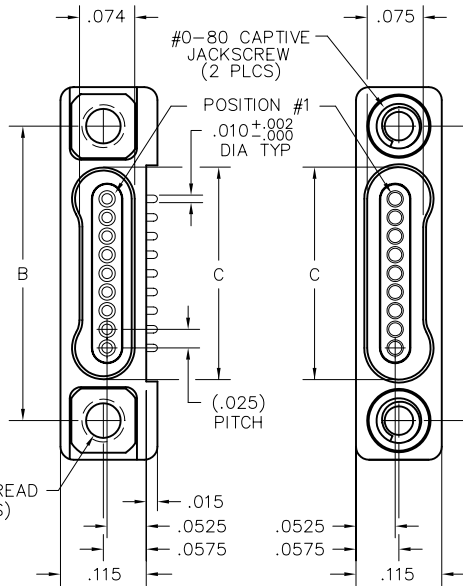

RECEPTACLE

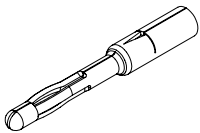

PIN CONTACT
3 TINE SPRING MEMBER, CRIMP

SIZE	A	B	C		D
			PLUG	RCPT	
9	.500	.395	.284	.285	.290
15	.650	.545	.434	.435	.440
21	.800	.695	.584	.585	.590
25	.900	.795	.684	.685	.690
31	1.050	.945	.834	.835	.840
37	1.200	1.095	.984	.985	.990
51	1.550	1.445	1.334	1.335	1.340

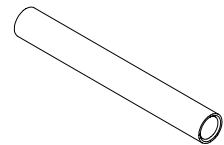

SOCKET CONTACT
DRAWN TUBE, CRIMP

** = HEX MEASUREMENT TAKEN ACROSS THE FLATS.

PLUG: NK-1C2-009-125-TH00
RECEPTACLE: NM-122-009-261-JCAC
 XX-XXX-XXX-XXX-XXXX

PLUG

RECEPTACLE

SERIES

NK .025" Metal PC Board Mounted Connector | NM .025" Metal I/O Connector

BODY

1	1-Row	1	1-Row
BODY STYLE:		BODY STYLE:	
C	Plug, horizontal mount SMT	2	Receptacle, straight
BODY MATERIAL:		BODY MATERIAL:	
2	Liquid Crystal Polymer w/ electroless nickel shell	2	Liquid Crystal Polymer w/ electroless nickel shell
3	Liquid Crystal Polymer w/ electrodeposited cadmium shell <input checked="" type="checkbox"/>	3	Liquid Crystal Polymer w/ electrodeposited cadmium shell <input checked="" type="checkbox"/>

SIZE

XXX Number of contacts (009, 015, 021, 025, 031, 037 or 051) | XXX Number of contacts (009, 015, 021, 025, 031, 037 or 051)

CONTACTS

TYPE CONTACTS/TERMINATIONS:		TYPE CONTACTS/TERMINATIONS:	
12	Pin, SMT	26	Socket, straight, crimped wire
PLATING OPTIONS:		PLATING OPTIONS:	
5	50 u" Au contacts; Sn/Pb alloy terminations <input checked="" type="checkbox"/>	1	50 u" Au contacts
8	50 u" Au contacts; Tin plated terminations		

HARDWARE

STYLE OF HARDWARE:		STYLE OF HARDWARE:	
00	None	00	None
TH	Threaded hole, #0-80 UNF	JC	Turning jackscrews, captivated #0-80 UNF*
WIRING OPTIONS:		WIRING OPTIONS:	
00	None	XX	See wiring codes, Page NA-2

* = Recommended torque value 1.0 inch-lbs. max.
 Ball end hex wrench not recommended
 Hex wrench key/bit conforming to the requirements of ASME / ANSI-B-18.3 is recommended.
 .050" hex L-key long arm wrench - order AirBorn p/n CDG14148.

= Option not RoHS compliant

1 · ROW Cable to Board Horizontal SMT

.025"

NM, NK

9 thru 51 Contacts

NM-112-009-161-JCAC
(METAL)

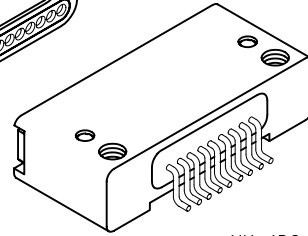
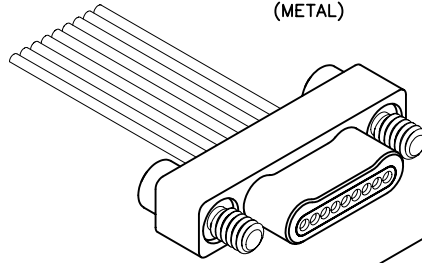

NK-1D2-009-225-TH00
(METAL)

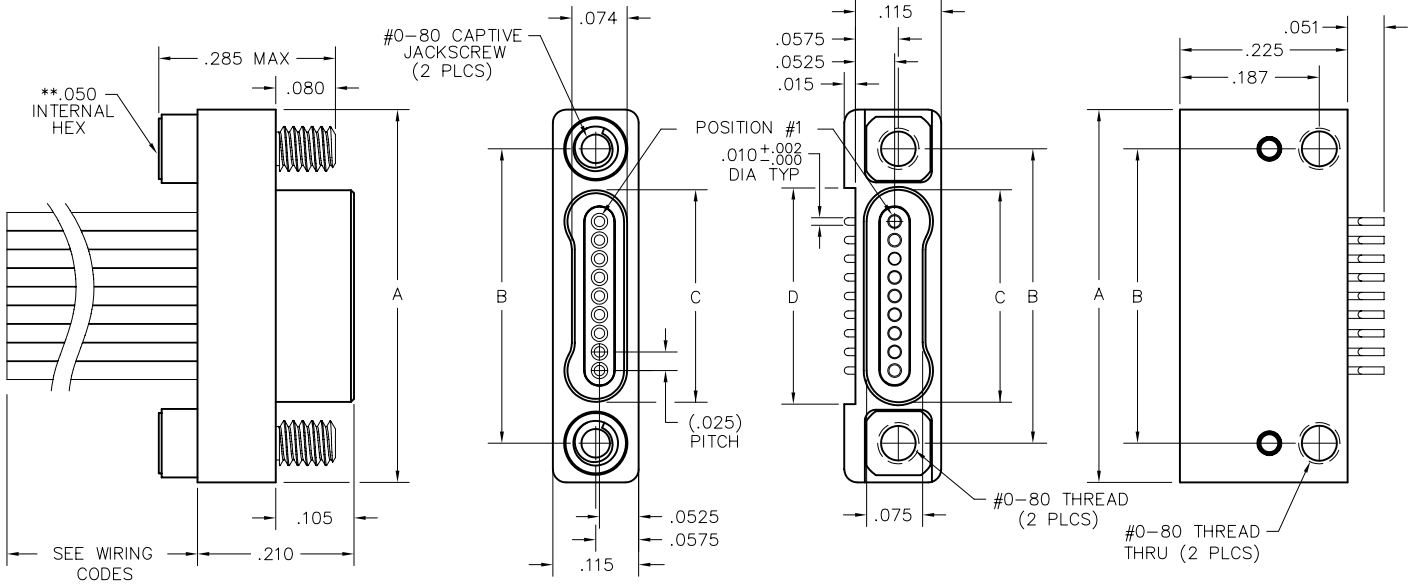

PLUG

RECEPTACLE

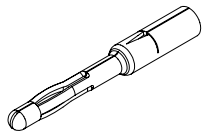

PIN CONTACT
3 TINE SPRING MEMBER, CRIMP

SIZE	A	B	C		D
			PLUG	RCPT	
9	.500	.395	.284	.285	.290
15	.650	.545	.434	.435	.440
21	.800	.695	.584	.585	.590
25	.900	.795	.684	.685	.690
31	1.050	.945	.834	.835	.840
37	1.200	1.095	.984	.985	.990
51	1.550	1.445	1.334	1.335	1.340

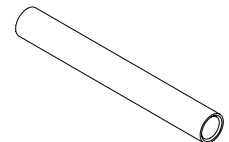

SOCKET CONTACT
DRAWN TUBE, CRIMP

** = HEX MEASUREMENT TAKEN ACROSS THE FLATS.

PLUG: NM-112-009-161-JCAC
RECEPTACLE: NK-1D2-009-225-TH00
 XX-XXX-XXX-XXX-XXXX

PLUG		RECEPTACLE	
SERIES			
NM .025" Metal I/O Connector		NK .025" Metal PC Board Mounted Connector	
BODY			
1	1-Row	1	1-Row
1	Plug, straight	D	BODY STYLE: Receptacle, horizontal mount SMT
BODY MATERIAL:		BODY MATERIAL:	
2	Liquid Crystal Polymer w/ electroless nickel shell	2	Liquid Crystal Polymer w/ electroless nickel shell
3	Liquid Crystal Polymer w/ electrodeposited cadmium shell <input checked="" type="checkbox"/>	3	Liquid Crystal Polymer w/ electrodeposited cadmium shell <input checked="" type="checkbox"/>
SIZE			
XXX Number of contacts (009, 015, 021, 025, 031, 037 or 051)		XXX Number of contacts (009, 015, 021, 025, 031, 037 or 051)	
CONTACTS			
TYPE CONTACTS/TERMINATIONS:		TYPE CONTACTS/TERMINATIONS:	
16	Pin, straight, crimped wire	22	Socket, SMT
PLATING OPTIONS:		PLATING OPTIONS:	
1	50 u" Au contacts	5	50 u" Au contacts; Sn/Pb alloy terminations <input checked="" type="checkbox"/>
		8	50 u" Au contacts; Tin plated terminations
HARDWARE			
STYLE OF HARDWARE:		STYLE OF HARDWARE:	
00	None	00	None
JC	Turning jackscrews, captivated #0-80 UNF*	TH	Threaded hole, #0-80 UNF
WIRING OPTIONS:		WIRING OPTIONS:	
XX	See wiring codes, Page NA-2	00	None

* = Recommended torque value 1.0 inch-lbs. max.
 Ball end hex wrench not recommended
 Hex wrench key/bit conforming to the requirements of ASME / ANSI-B-18.3 is recommended.
 .050" hex L-key long arm wrench - order AirBorn p/n CDG14148.

= Option not RoHS compliant



Recommended PC Board Layout

Horizontal SMT Plug
FOR REFERENCE ONLY

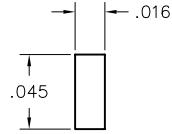

FOOTPRINT / PAD CONFIGURATION

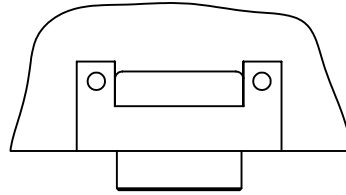

PC BOARD LAYOUT COMPONENT SIDE

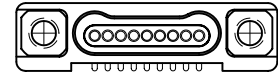
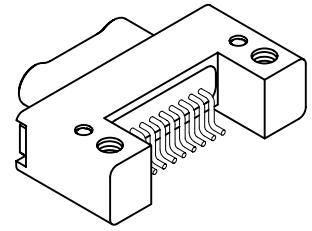

CONNECTOR MATING FACE

9 POSITION

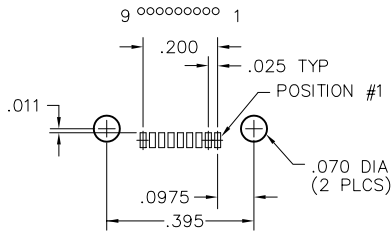

15 POSITION

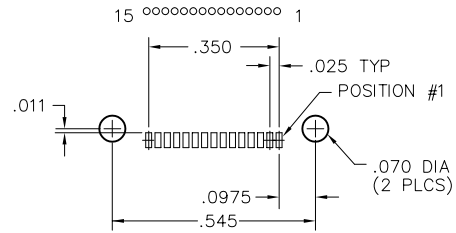

21 POSITION

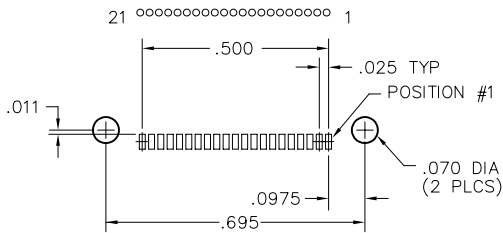

25 POSITION

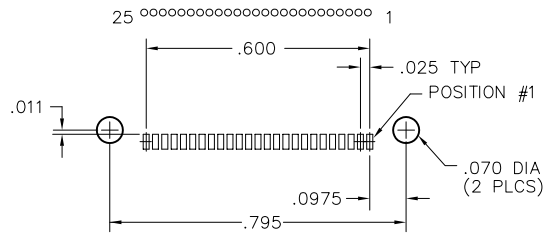

31 POSITION

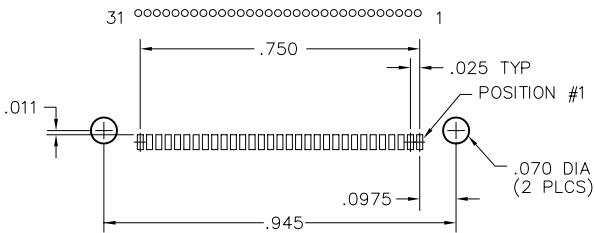

37 POSITION

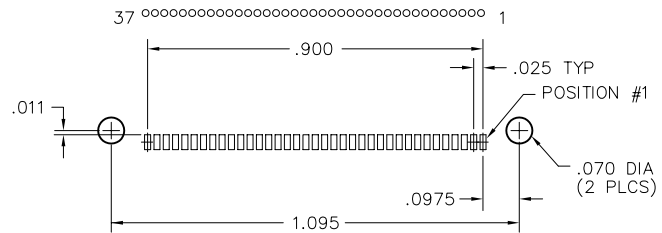

51 POSITION

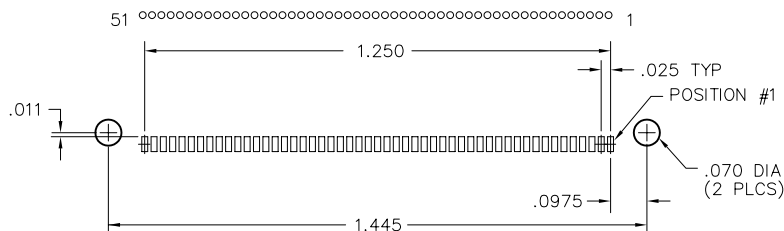



Recommended PC Board Layout

Horizontal SMT Receptacle
FOR REFERENCE ONLY

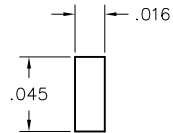

FOOTPRINT / PAD CONFIGURATION

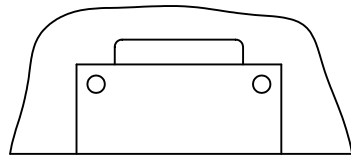

PC BOARD LAYOUT COMPONENT SIDE

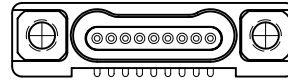
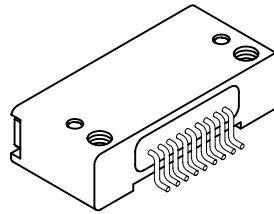

CONNECTOR MATING FACE

9 POSITION

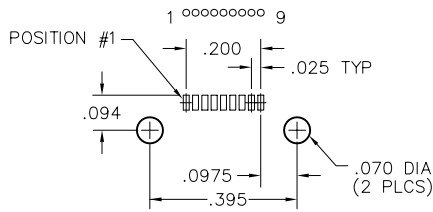

15 POSITION

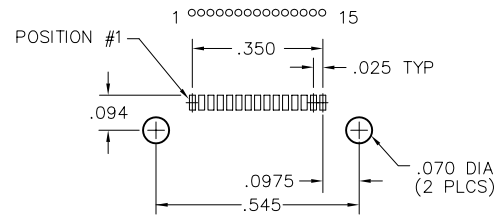

21 POSITION

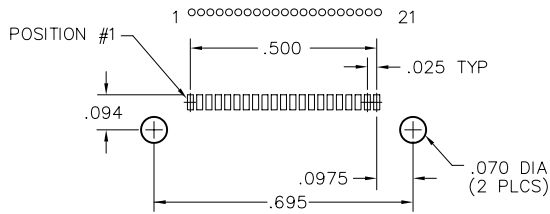

25 POSITION

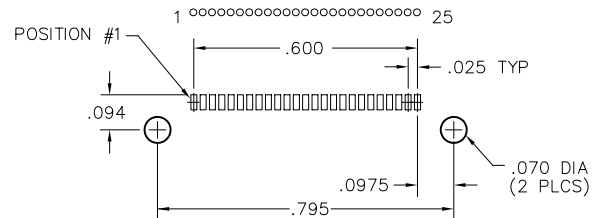

31 POSITION

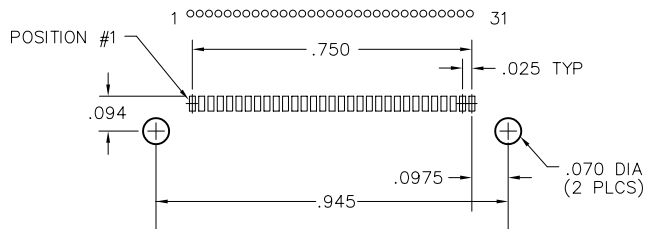

37 POSITION

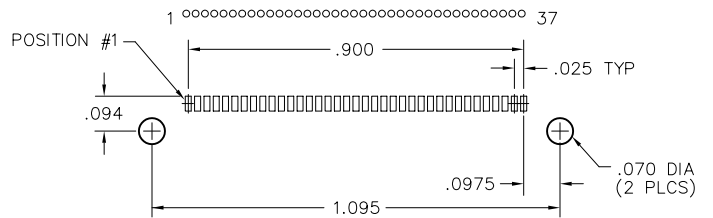

51 POSITION

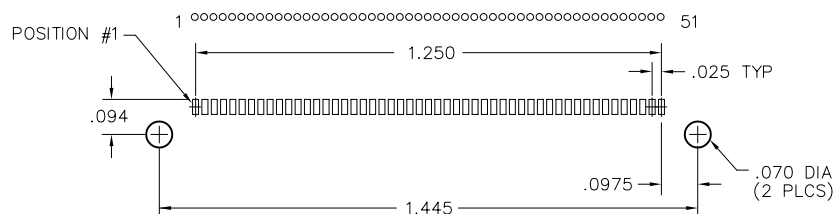

1 · ROW Cable to Board Vertical SMT

.025"

NM, NK

9 thru 51 Contacts

NM-122-009-261-JCAC
(METAL)

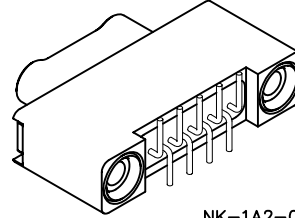
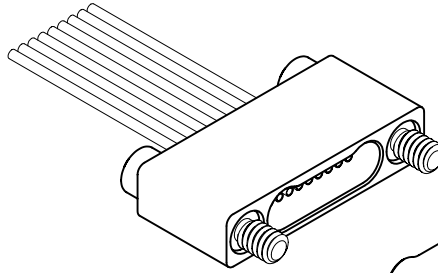

NK-1A2-009-125-TH00
(METAL)

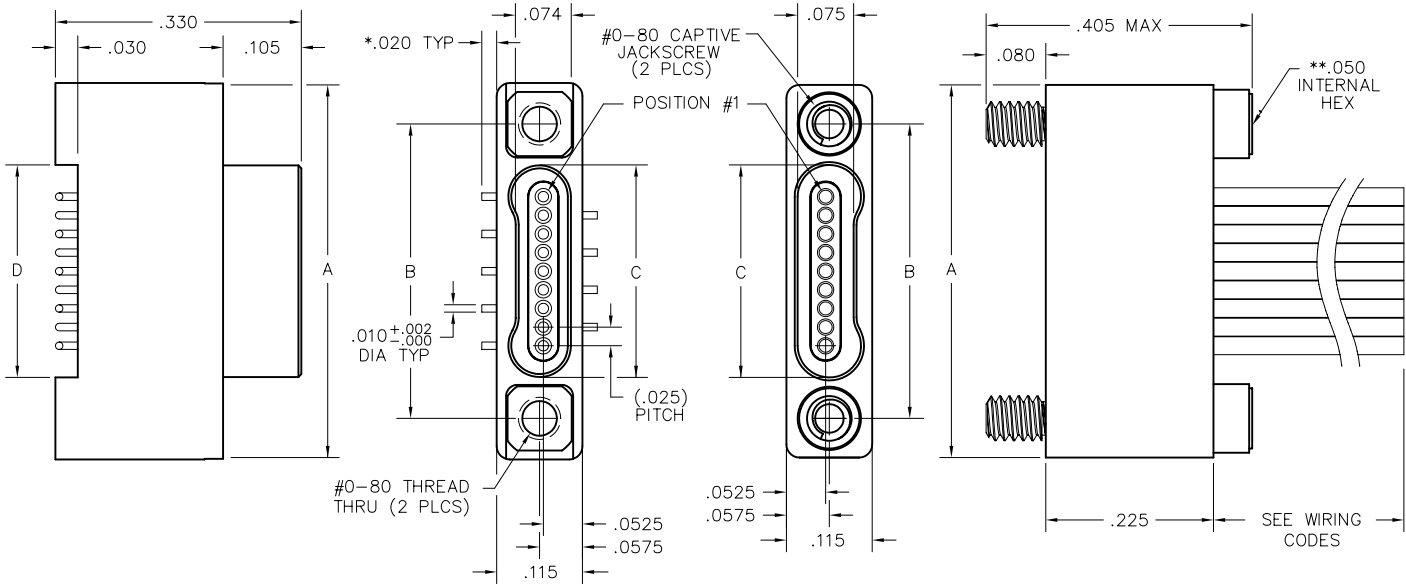

PLUG

RECEPTACLE

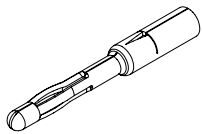

PIN CONTACT
3 TINE SPRING MEMBER, CRIMP

SIZE	A	B	C		D
			PLUG	RCPT	
9	.500	.395	.284	.285	.287
15	.650	.545	.434	.435	.437
21	.800	.695	.584	.585	.587
25	.900	.795	.684	.685	.687
31	1.050	.945	.834	.835	.837
37	1.200	1.095	.984	.985	.987
51	1.550	1.445	1.334	1.335	1.337

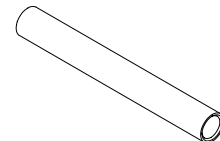

SOCKET CONTACT
DRAWN TUBE, CRIMP

* = DIMENSION CHANGES TO .040" FOR
"010" OPTION. SEE PAGE N-20.
** = HEX MEASUREMENT TAKEN ACROSS FLATS.

PLUG: NK-1A2-009-125-TH00
RECEPTACLE: NM-122-009-261-JCAC
 XX-XXX-XXX-XXX-XXXX-XXX

PLUG

RECEPTACLE

SERIES

NK .025" Metal PC Board Mounted Connector | NM .025" Metal I/O Connector

BODY

1	1-Row	1	1-Row
BODY STYLE:		BODY STYLE:	
A	Plug, vertical mount SMT	2	Receptacle, straight
BODY MATERIAL:		BODY MATERIAL:	
2	Liquid Crystal Polymer w/ electroless nickel shell	2	Liquid Crystal Polymer w/ electroless nickel shell
3	Liquid Crystal Polymer w/ electrodeposited cadmium shell <input checked="" type="checkbox"/>	3	Liquid Crystal Polymer w/ electrodeposited cadmium shell <input checked="" type="checkbox"/>

SIZE

XXX Number of contacts (009, 015, 021, 025, 031, 037 or 051) | XXX Number of contacts (009, 015, 021, 025, 031, 037 or 051)

CONTACTS

TYPE CONTACTS/TERMINATIONS:		TYPE CONTACTS/TERMINATIONS:	
12	Pin, SMT (.020 lead envelope)	26	Socket, straight, crimped wire
PLATING OPTIONS:		PLATING OPTIONS:	
5	50 u" Au contacts; Sn/Pb alloy terminations <input checked="" type="checkbox"/>	1	50 u" Au contacts
8	50 u" Au contacts; Tin plated terminations		

HARDWARE

STYLE OF HARDWARE:		STYLE OF HARDWARE:	
00	None	00	None
TH	Threaded hole, #0-80 UNF	JC	Turning jackscrews, captivated #0-80 UNF*
WIRING OPTIONS:		WIRING OPTIONS:	
00	None	XX	See wiring codes, Page NA-2

OPTIONS

010 .040 lead envelope

* = Recommended torque value 1.0 inch-lbs. max.
 Ball end hex wrench not recommended
 Hex wrench key/bit conforming to the requirements of ASME / ANSI-B-18.3 is recommended.
 .050" hex L-key long arm wrench - order AirBorn p/n CDG14148.

= Option not RoHS compliant

1 · ROW Cable to Board Vertical SMT

.025"

NM, NK

9 thru 51 Contacts

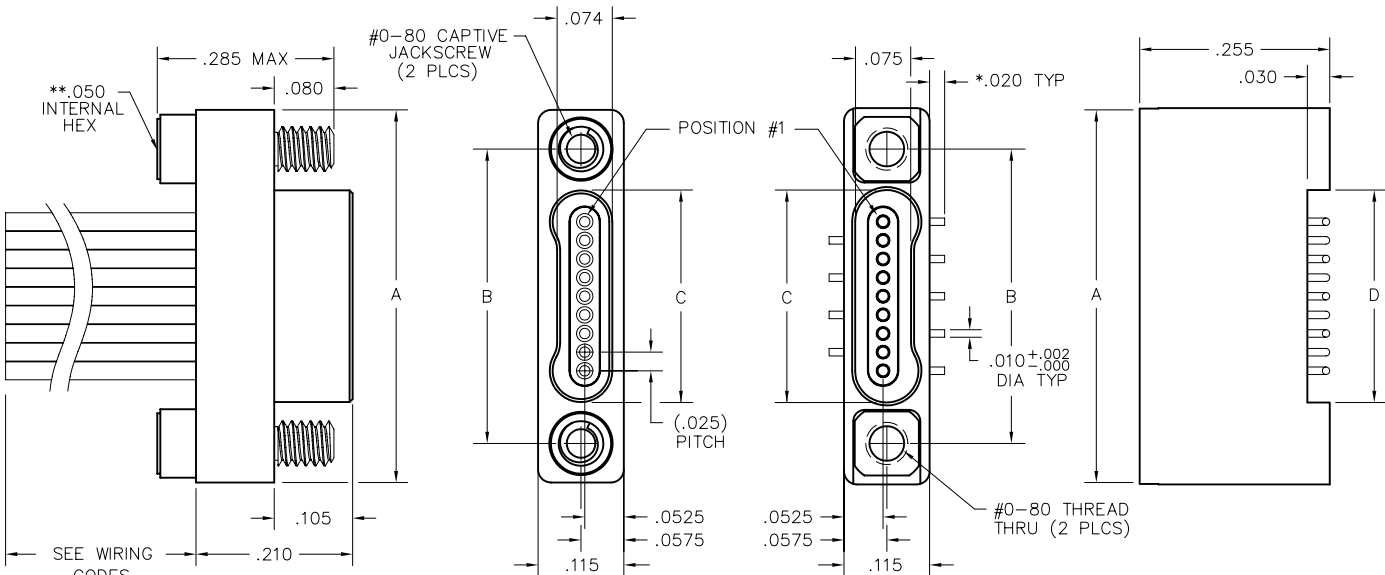
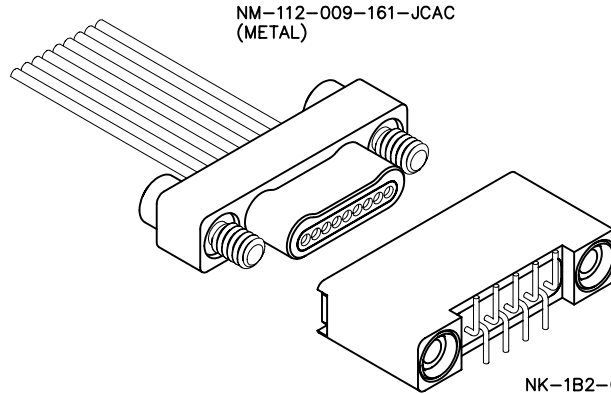

PLUG

RECEPTACLE

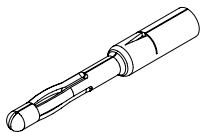

PIN CONTACT
3 TINE SPRING MEMBER, CRIMP

SIZE	A	B	C		D
			PLUG	RCPT	
9	.500	.395	.284	.285	.287
15	.650	.545	.434	.435	.437
21	.800	.695	.584	.585	.587
25	.900	.795	.684	.685	.687
31	1.050	.945	.834	.835	.837
37	1.200	1.095	.984	.985	.987
51	1.550	1.445	1.334	1.335	1.337

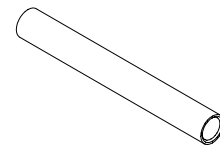

SOCKET CONTACT
DRAWN TUBE, CRIMP

* = DIMENSION CHANGES TO .040" FOR
".010" OPTION. SEE PAGE N-22.
** = HEX MEASUREMENT TAKEN ACROSS THE FLATS.

PLUG: NM-112-009-161-JCAC
RECEPTACLE: NK-1B2-009-225-TH00
 XX-XXX-XXX-XXX-XXXX-XXX

PLUG

RECEPTACLE

SERIES	
NM .025" Metal I/O Connector	NK .025" Metal PC Board Mounted Connector

BODY	
1 1-Row	1 1-Row
BODY STYLE: 1 Plug, straight	BODY STYLE: B Receptacle, vertical mount SMT
BODY MATERIAL: 2 Liquid Crystal Polymer w/ electroless nickel shell 3 Liquid Crystal Polymer w/ electrodeposited cadmium shell <input checked="" type="checkbox"/>	BODY MATERIAL: 2 Liquid Crystal Polymer w/ electroless nickel shell 3 Liquid Crystal Polymer w/ electrodeposited cadmium shell <input checked="" type="checkbox"/>

SIZE	
XXX Number of contacts (009, 015, 021, 025, 031, 037 or 051)	XXX Number of contacts (009, 015, 021, 025, 031, 037 or 051)

CONTACTS	
TYPE CONTACTS/TERMINATIONS: 16 Pin, straight, crimped wire	TYPE CONTACTS/TERMINATIONS: 22 Socket, SMT (.020 lead envelope)
PLATING OPTIONS: 1 50 u" Au contacts	PLATING OPTIONS: 5 50 u" Au contacts; Sn/Pb alloy terminations <input checked="" type="checkbox"/> 8 50 u" Au contacts; Tin plated terminations

HARDWARE	
STYLE OF HARDWARE: 00 None JC Turning jackscrews, captivated #0-80 UNF*	STYLE OF HARDWARE: 00 None TH Threaded hole, #0-80 UNF
WIRING OPTIONS: XX See wiring codes, Page NA-2	WIRING OPTIONS: 00 None

OPTIONS	
	010 .040 lead envelope

* = Recommended torque value 1.0 inch-lbs. max.
 Ball end hex wrench not recommended
 Hex wrench key/bit conforming to the requirements of ASME / ANSI-B-18.3 is recommended.
 .050" hex L-key long arm wrench - order AirBorn p/n CDG14148.

= Option not RoHS compliant



Recommended PC Board Layout

Vertical SMT Plug
 .020 & .040 Lead Envelopes
 FOR REFERENCE ONLY

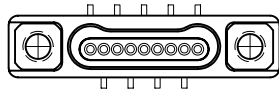
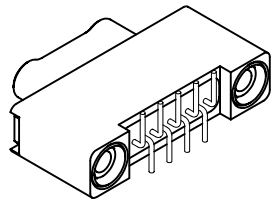

CONNECTOR MATING FACE

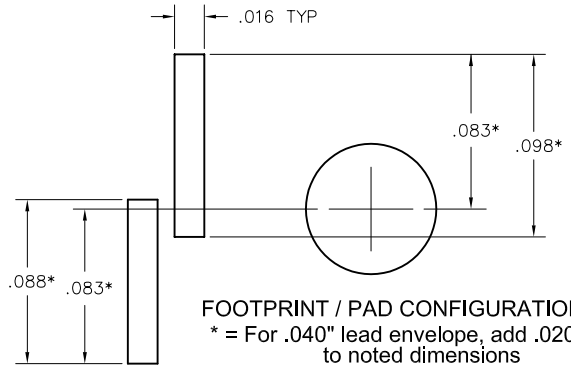

9 POSITION

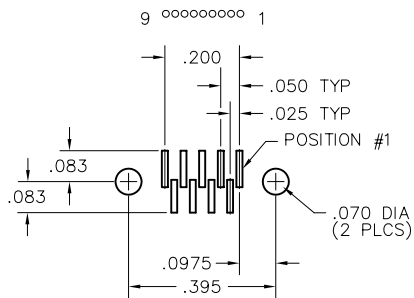

15 POSITION

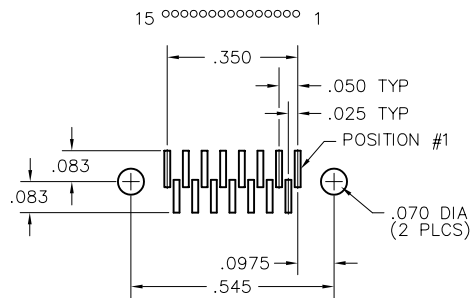

21 POSITION

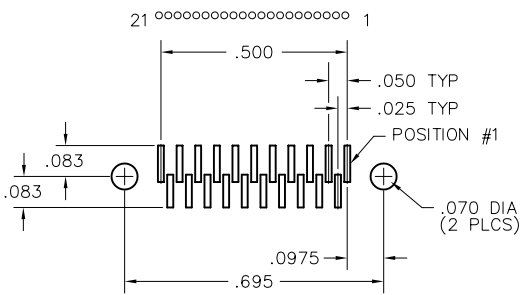

25 POSITION

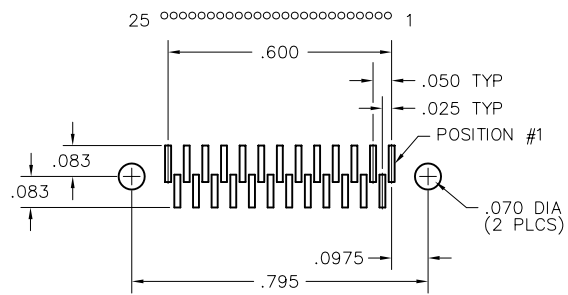

31 POSITION

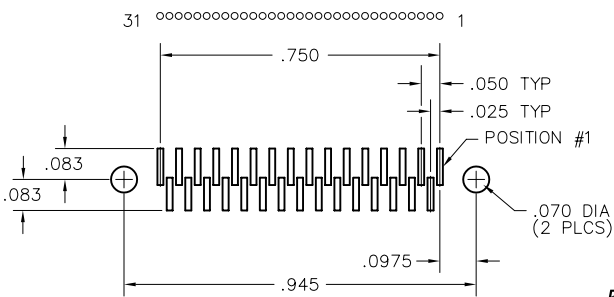

37 POSITION

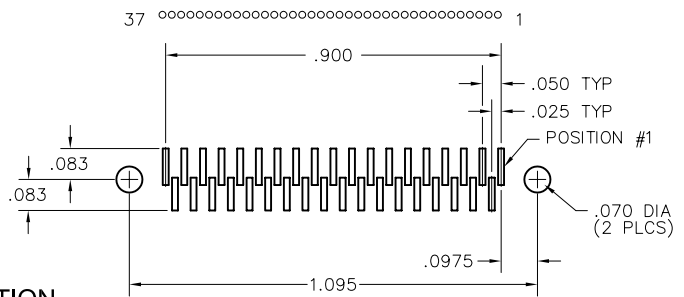

51 POSITION

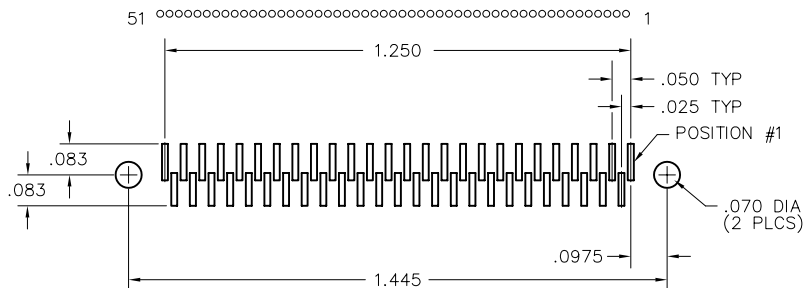



Recommended PC Board Layout

Vertical SMT Receptacle
.020 & .040 Lead Envelopes
FOR REFERENCE ONLY

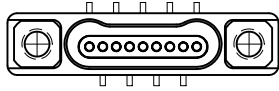
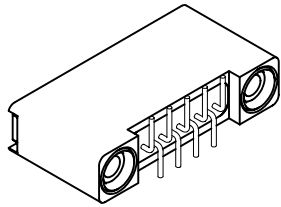

CONNECTOR MATING FACE

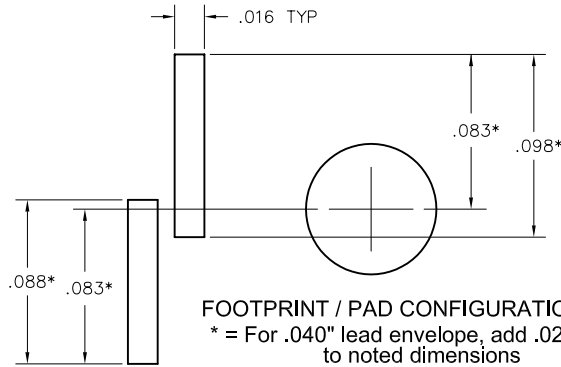

9 POSITION

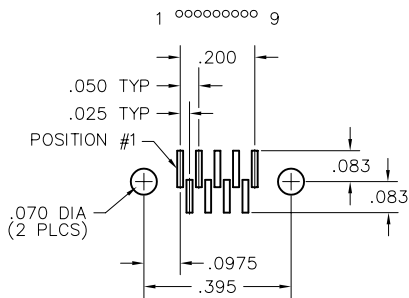

15 POSITION

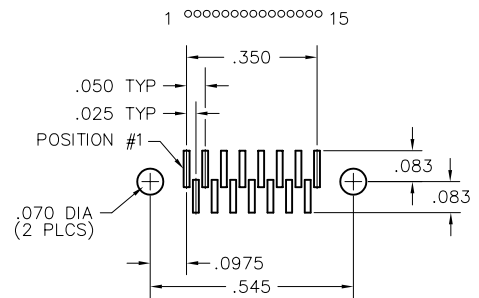

21 POSITION

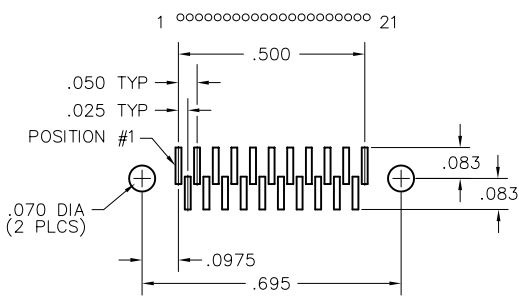

25 POSITION

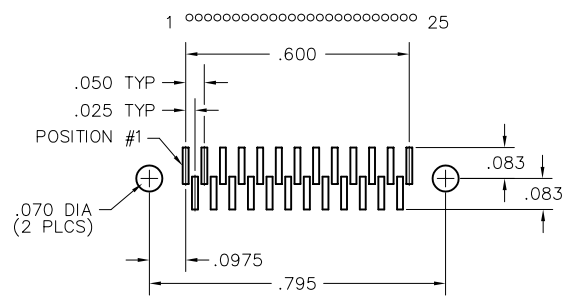

31 POSITION

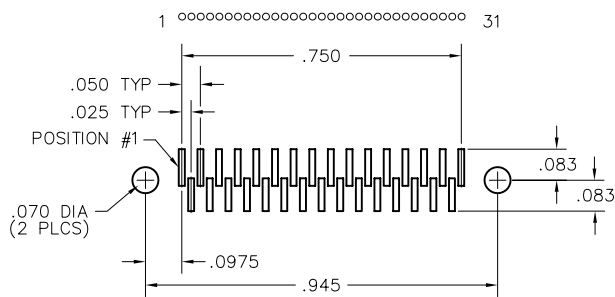

37 POSITION

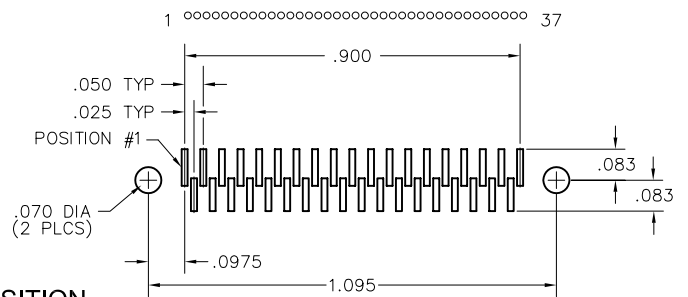

51 POSITION

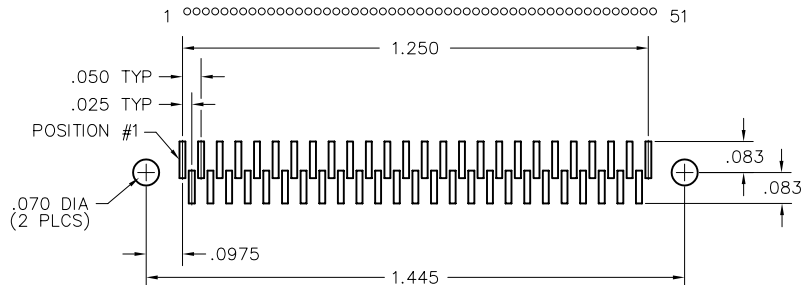



1 · ROW Cable to Board Right Angle PTH

.025"

NM, NK

9 thru 51 Contacts

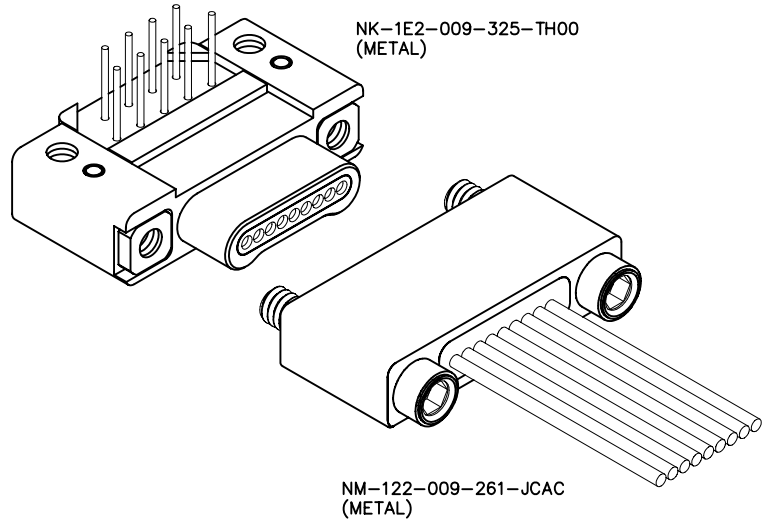

NK-1E2-009-325-TH00
(METAL)

NM-122-009-261-JCAC
(METAL)

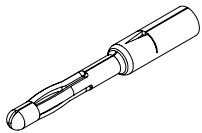
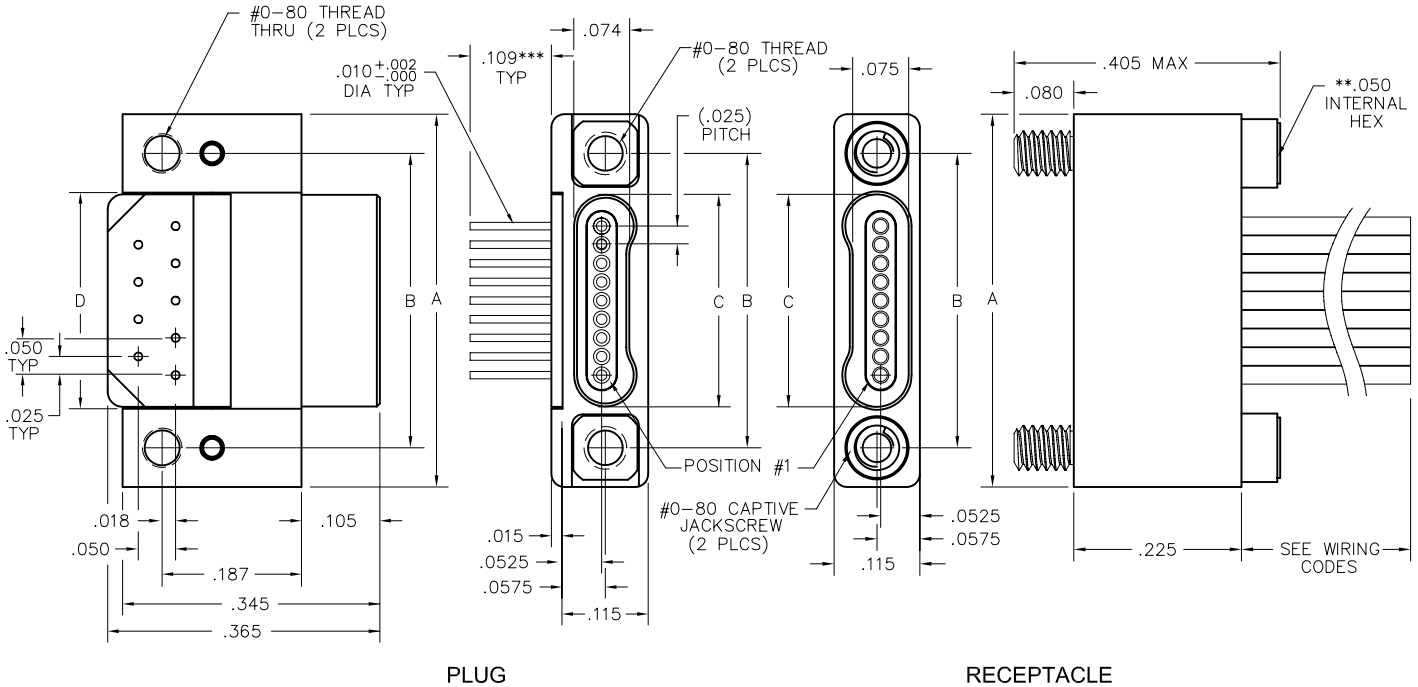

PIN CONTACT
3 TINE SPRING MEMBER, CRIMP

SIZE	A	B	C		D
			PLUG	RCPT	
9	.500	.395	.284	.285	.290
15	.650	.545	.434	.435	.440
21	.800	.695	.584	.585	.590
25	.900	.795	.684	.685	.690
31	1.050	.945	.834	.835	.840
37	1.200	1.095	.984	.985	.990
51	1.550	1.445	1.334	1.335	1.340

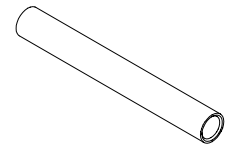

SOCKET CONTACT
DRAWN TUBE, CRIMP

** = HEX MEASUREMENT TAKEN ACROSS THE FLATS.
*** = OTHER LENGTHS AS REQUIRED

PLUG: NK-1E2-009-325-TH00
RECEPTACLE: NM-122-009-261-JCAC
 XX-XXX-XXX-XXX-XXXX

PLUG

RECEPTACLE

SERIES

NK .025" Metal PC Board Mounted Connector | NM .025" Metal I/O Connector

BODY

1	1-Row	1	1-Row
BODY STYLE:		BODY STYLE:	
E	Plug, right angle, plated thru hole (PTH)	2	Receptacle, straight
BODY MATERIAL:		BODY MATERIAL:	
2	Liquid Crystal Polymer w/ electroless nickel shell	2	Liquid Crystal Polymer w/ electroless nickel shell
3	Liquid Crystal Polymer w/ electrodeposited cadmium shell <input checked="" type="checkbox"/>	3	Liquid Crystal Polymer w/ electrodeposited cadmium shell <input checked="" type="checkbox"/>

SIZE

XXX Number of contacts (009, 015, 021, 025, 031, 037 or 051) | XXX Number of contacts (009, 015, 021, 025, 031, 037 or 051)

CONTACTS

TYPE CONTACTS/TERMINATIONS:		TYPE CONTACTS/TERMINATIONS:	
32	Pin, right angle, .109"	26	Socket, straight, crimped wire
33	Pin, right angle, .140"		
34	Pin, right angle, .172"		
PLATING OPTIONS:		PLATING OPTIONS:	
5	50 u" Au contacts; Sn/Pb alloy terminations <input checked="" type="checkbox"/>	1	50 u" Au contacts
8	50 u" Au contacts; Tin plated terminations		

HARDWARE

STYLE OF HARDWARE:		STYLE OF HARDWARE:	
00	None	00	None
TH	Threaded hole, #0-80 UNF	JC	Turning jackscrews, captivated #0-80 UNF*
WIRING OPTIONS:		WIRING OPTIONS:	
00	None	XX	See wiring codes, Page NA-2

* = Recommended torque value 1.0 inch-lbs. max.
 Ball end hex wrench not recommended
 Hex wrench key/bit conforming to the requirements of ASME / ANSI-B-18.3 is recommended.
 .050" hex L-key long arm wrench - order AirBorn p/n CDG14148.

= Option not RoHS compliant

NK-1F2-009-435-TH00
(METAL)

1 · ROW Cable to Board Right Angle PTH

.025"

NM, NK

9 thru 51 Contacts

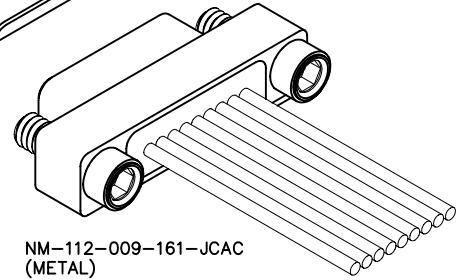
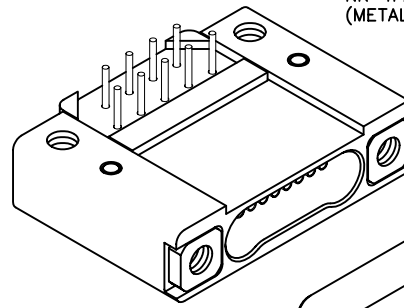

NM-112-009-161-JCAC
(METAL)

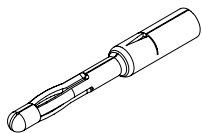
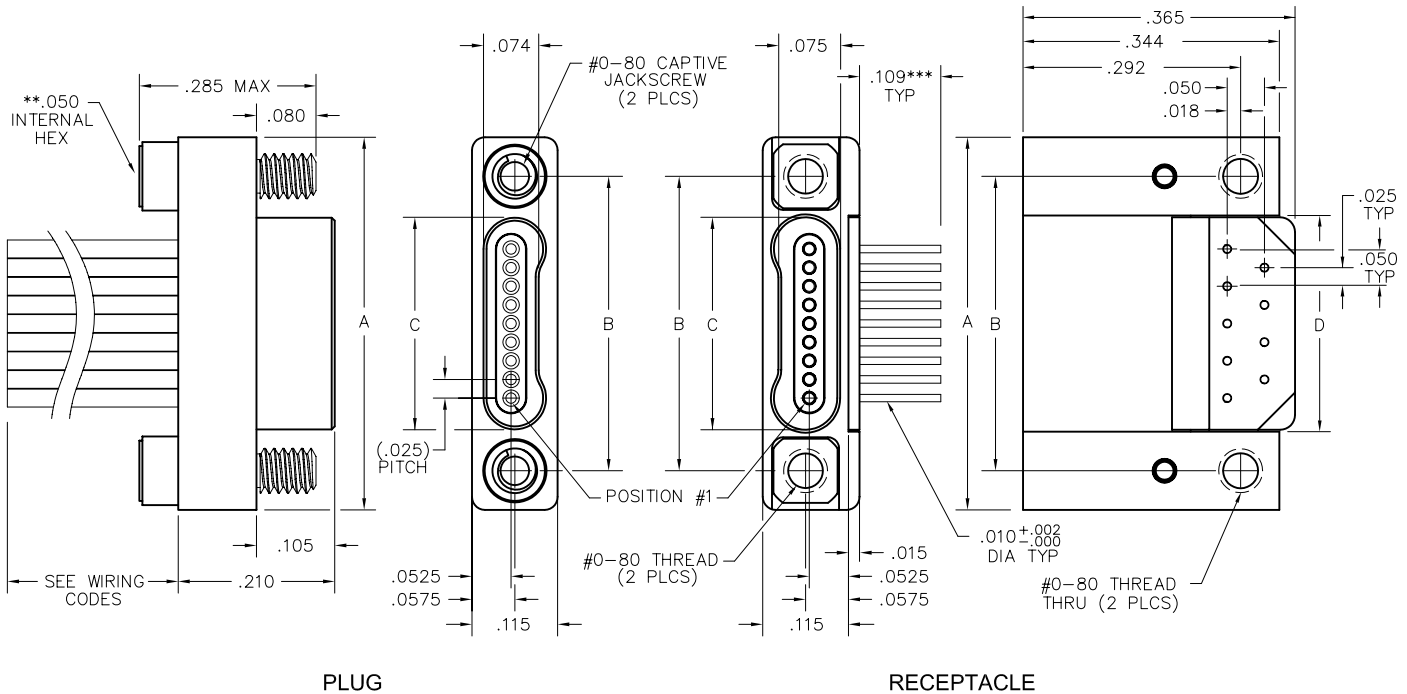

PIN CONTACT
3 TINE SPRING MEMBER, CRIMP

SIZE	A	B	C		D
			PLUG	RCPT	
9	.500	.395	.284	.285	.290
15	.650	.545	.434	.435	.440
21	.800	.695	.584	.585	.590
25	.900	.795	.684	.685	.690
31	1.050	.945	.834	.835	.840
37	1.200	1.095	.984	.985	.990
51	1.550	1.445	1.334	1.335	1.340

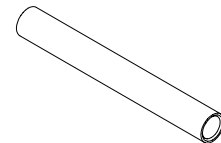

SOCKET CONTACT
DRAWN TUBE, CRIMP

** = HEX MEASUREMENT TAKEN ACROSS THE FLATS.
*** = OTHER LENGTHS AS REQUIRED

PLUG: NM-112-009-161-JCAC
RECEPTACLE: NK-1F2-009-435-TH00
 XX-XXX-XXX-XXX-XXXX

PLUG		RECEPTACLE	
SERIES			
NM .025" Metal I/O Connector		NK .025" Metal PC Board Mounted Connector	
BODY			
1	1-Row	1	1-Row
BODY STYLE: 1 Plug, straight		BODY STYLE: F Receptacle, right angle, plated thru hole (PTH)	
BODY MATERIAL: 2 Liquid Crystal Polymer w/ electroless nickel shell 3 Liquid Crystal Polymer w/ electrodeposited cadmium shell <input checked="" type="checkbox"/>		BODY MATERIAL: 2 Liquid Crystal Polymer w/ electroless nickel shell 3 Liquid Crystal Polymer w/ electrodeposited cadmium shell <input checked="" type="checkbox"/>	
SIZE			
XXX Number of contacts (009, 015, 021, 025, 031, 037 or 051)		XXX Number of contacts (009, 015, 021, 025, 031, 037 or 051)	
CONTACTS			
TYPE CONTACTS/TERMINATIONS: 16 Pin, straight, crimped wire		TYPE CONTACTS/TERMINATIONS: 43 Socket, right angle, .109" 44 Socket, right angle, .140" 45 Socket, right angle, .172"	
PLATING OPTIONS: 1 50 u" Au contacts		PLATING OPTIONS: 5 50 u" Au contacts; Sn/Pb alloy terminations <input checked="" type="checkbox"/> 8 50 u" Au contacts; Tin plated terminations	
HARDWARE			
STYLE OF HARDWARE: 00 None JC Turning jackscrews, captivated #0-80 UNF*		STYLE OF HARDWARE: 00 None TH Threaded hole, #0-80 UNF	
WIRING OPTIONS: XX See wiring codes, Page NA-2		WIRING OPTIONS: 00 None	

* = Recommended torque value 1.0 inch-lbs. max.
 Ball end hex wrench not recommended
 Hex wrench key/bit conforming to the requirements of ASME / ANSI-B-18.3 is recommended.
 .050" hex L-key long arm wrench - order AirBorn p/n CDG14148.

= Option not RoHS compliant



Recommended PC Board Layout

Right Angle PTH Plug
FOR REFERENCE ONLY

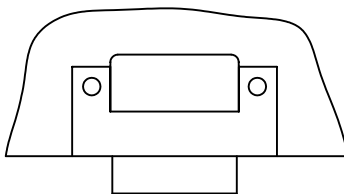

PC BOARD LAYOUT
COMPONENT SIDE

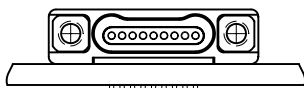
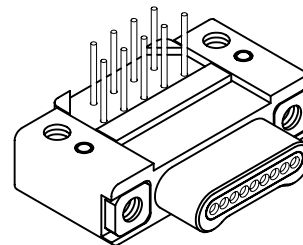

CONNECTOR MATING FACE

9 POSITION

9 ○○○○○○○○ 1

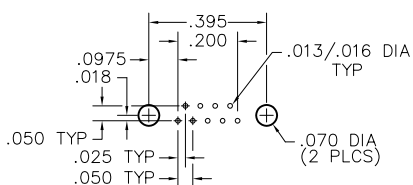

15 POSITION

15 ○○○○○○○○○○ 1

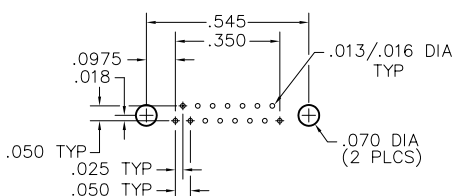

21 POSITION

21 ○○○○○○○○○○○○ 1

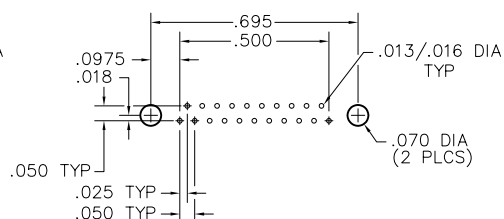

25 POSITION

25 ○○○○○○○○○○○○ 1

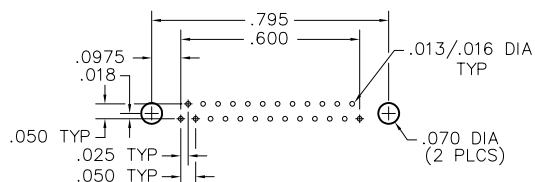

31 POSITION

31 ○○○○○○○○○○○○○○ 1

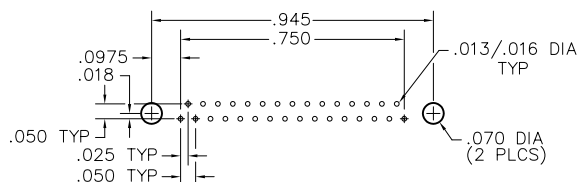

37 POSITION

37 ○○○○○○○○○○○○○○○○ 1

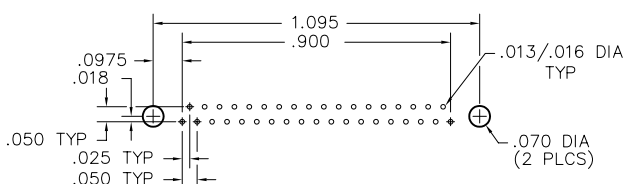

51 POSITION

51 ○○○○○○○○○○○○○○○○○○○○ 1

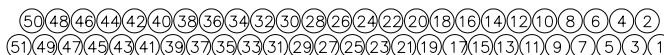
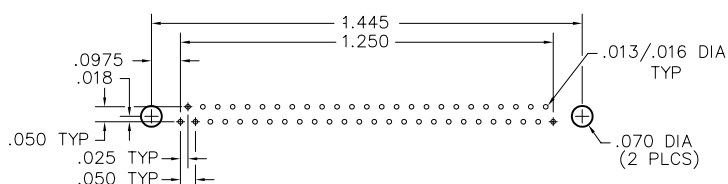

Recommended PC Board Layout

Right Angle PTH Receptacle
FOR REFERENCE ONLY

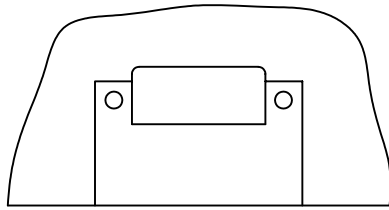

PC BOARD LAYOUT
COMPONENT SIDE

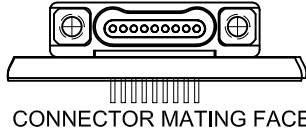
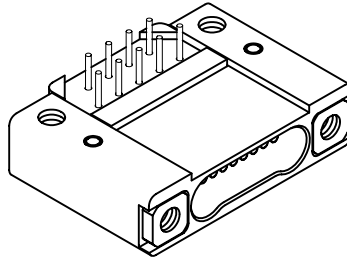

CONNECTOR MATING FACE

9 POSITION

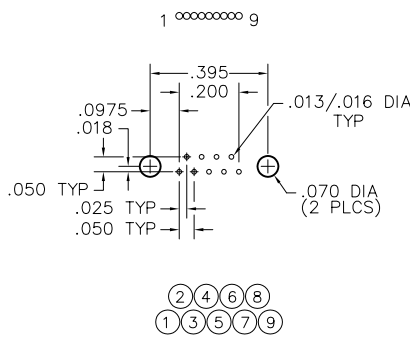

15 POSITION

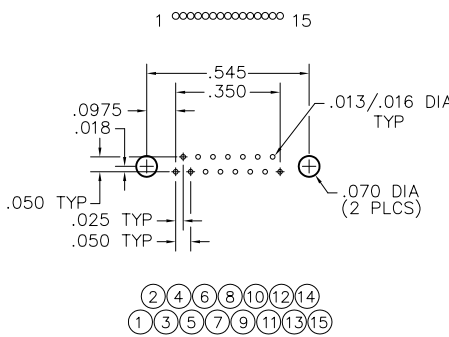

21 POSITION

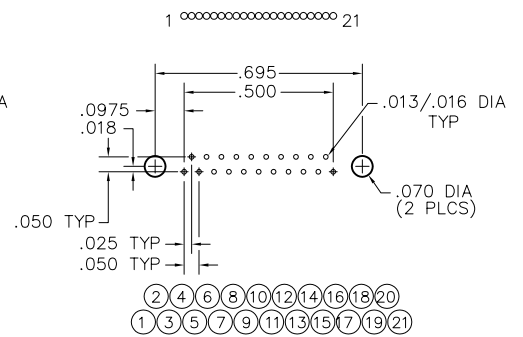

25 POSITION

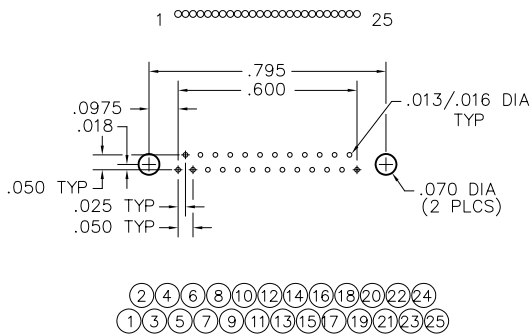

31 POSITION

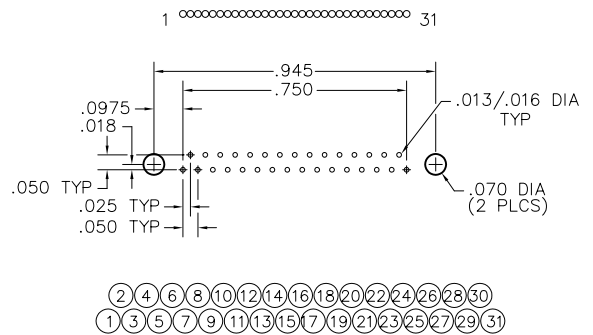

37 POSITION

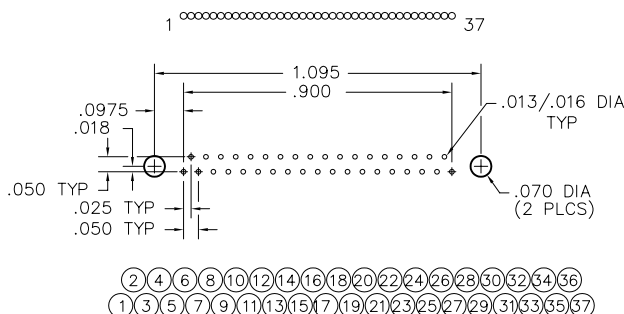

51 POSITION

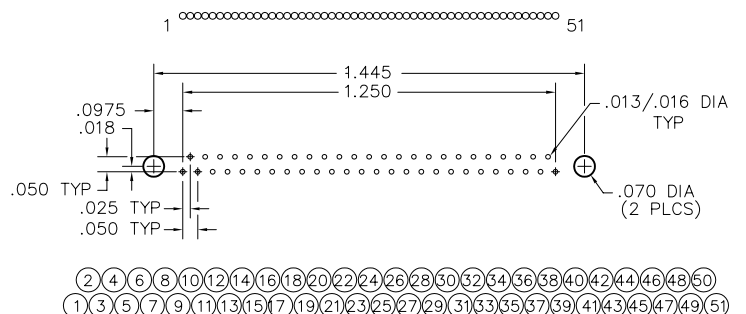

1 · ROW Cable to Board Vertical PTH

.025"

NM, NK

9 thru 51 Contacts

NM-122-009-261-JCAC
(METAL)

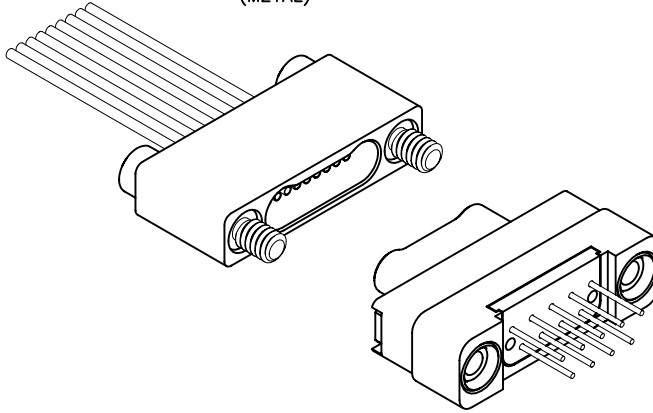

NK-1G2-009-135-TH00
(METAL)

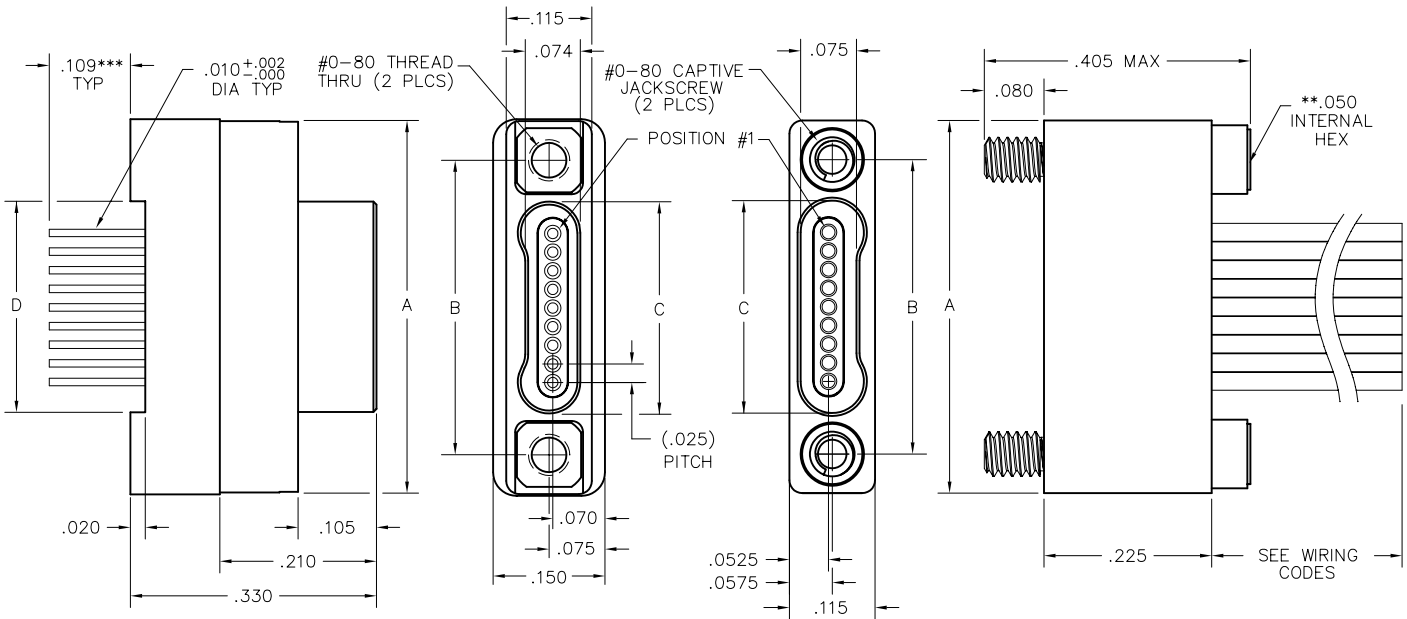

PLUG

RECEPTACLE

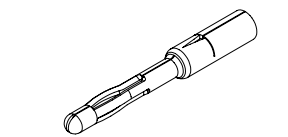

PIN CONTACT
3 TINE SPRING MEMBER, CRIMP

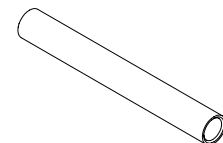

SOCKET CONTACT
DRAWN TUBE, CRIMP

SIZE	A	B	C		D
			PLUG	RCPT	
9	.500	.395	.284	.285	.285
15	.650	.545	.434	.435	.435
21	.800	.695	.584	.585	.585
25	.900	.795	.684	.685	.685
31	1.050	.945	.834	.835	.835
37	1.200	1.095	.984	.985	.985
51	1.550	1.445	1.334	1.335	1.335

** = HEX MEASUREMENT TAKEN ACROSS THE FLATS.
*** = OTHER LENGTHS AS REQUIRED

PLUG: NK-1G2-009-135-TH00
RECEPTACLE: NM-122-009-261-JCAC
 XX-XXX-XXX-XXX-XXXX

PLUG

RECEPTACLE

SERIES

NK .025" Metal PC Board Mounted Connector	NM .025" Metal I/O Connector
---	------------------------------

BODY

1 1-Row	1 1-Row
BODY STYLE: G Plug, vertical mount, plated thru hole (PTH)	BODY STYLE: 2 Receptacle, straight
BODY MATERIAL: 2 Liquid Crystal Polymer w/ electroless nickel shell 3 Liquid Crystal Polymer w/ electrodeposited cadmium shell <input checked="" type="checkbox"/>	BODY MATERIAL: 2 Liquid Crystal Polymer w/ electroless nickel shell 3 Liquid Crystal Polymer w/ electrodeposited cadmium shell <input checked="" type="checkbox"/>

SIZE

XXX Number of contacts (009, 015, 021, 025, 031, 037 or 051)	XXX Number of contacts (009, 015, 021, 025, 031, 037 or 051)
--	--

CONTACTS

TYPE CONTACTS/TERMINATIONS: 13 Pin, straight, .109" 14 Pin, straight, .140" 15 Pin, straight, .172"	TYPE CONTACTS/TERMINATIONS: 26 Socket, straight, crimped wire
PLATING OPTIONS: 5 50 u" Au contacts; Sn/Pb alloy terminations <input checked="" type="checkbox"/> 8 50 u" Au contacts; Tin plated terminations	PLATING OPTIONS: 1 50 u" Au contacts

HARDWARE

STYLE OF HARDWARE: 00 None TH Threaded hole, #0-80 UNF	STYLE OF HARDWARE: 00 None JC Turning jackscrews, captivated #0-80 UNF*
WIRING OPTIONS: 00 None	WIRING OPTIONS: XX See wiring codes, Page NA-2

* = Recommended torque value 1.0 inch-lbs. max.
 Ball end hex wrench not recommended
 Hex wrench key/bit conforming to the requirements of ASME / ANSI-B-18.3 is recommended.
 .050" hex L-key long arm wrench - order AirBorn p/n CDG14148.

= Option not RoHS compliant

1 · ROW Cable to Board Vertical PTH

.025"

NM, NK

9 thru 51 Contacts

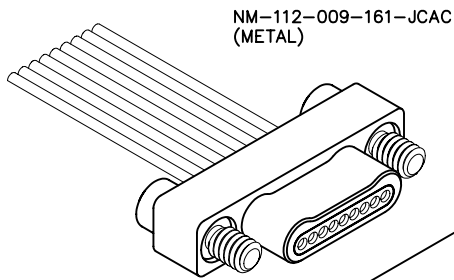

NM-112-009-161-JCAC
(METAL)

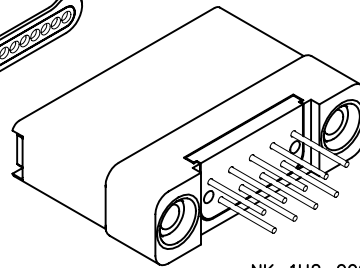

NK-1H2-009-235-TH00
(METAL)

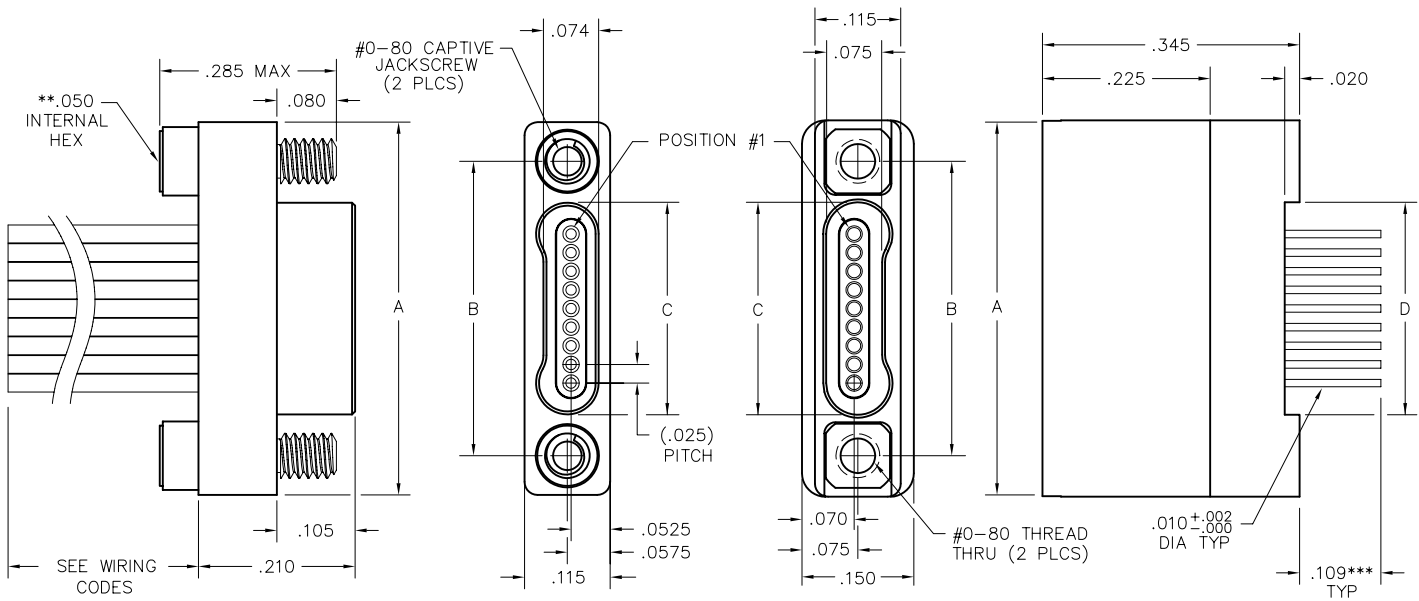

PLUG

RECEPTACLE

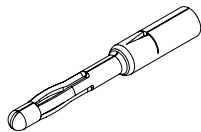

PIN CONTACT
3 TINE SPRING MEMBER, CRIMP

SIZE	DIMENSIONS		C		D
	A	B	PLUG	RCPT	
9	.500	.395	.284	.285	.285
15	.650	.545	.434	.435	.435
21	.800	.695	.584	.585	.585
25	.900	.795	.684	.685	.685
31	1.050	.945	.834	.835	.835
37	1.200	1.095	.984	.985	.985
51	1.550	1.445	1.334	1.335	1.335

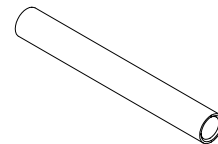

SOCKET CONTACT
DRAWN TUBE, CRIMP

** = HEX MEASUREMENT TAKEN ACROSS THE FLATS.
*** = OTHER LENGTHS AS REQUIRED

PLUG: NM-112-009-161-JCAC
RECEPTACLE: NK-1H2-009-235-TH00
 XX-XXX-XXX-XXX-XXXX

PLUG		RECEPTACLE	
SERIES			
NM .025" Metal I/O Connector		NK .025" Metal PC Board Mounted Connector	
BODY			
1 1-Row		1 1-Row	
BODY STYLE: 1 Plug, straight		BODY STYLE: H Receptacle, vertical mount, plated thru hole (PTH)	
BODY MATERIAL: 2 Liquid Crystal Polymer w/ electroless nickel shell 3 Liquid Crystal Polymer w/ electrodeposited cadmium shell <input checked="" type="checkbox"/>		BODY MATERIAL: 2 Liquid Crystal Polymer w/ electroless nickel shell 3 Liquid Crystal Polymer w/ electrodeposited cadmium shell <input checked="" type="checkbox"/>	
SIZE			
XXX Number of contacts (009, 015, 021, 025, 031, 037 or 051)		XXX Number of contacts (009, 015, 021, 025, 031, 037 or 051)	
CONTACTS			
TYPE CONTACTS/TERMINATIONS: 16 Pin, straight, crimped wire		TYPE CONTACTS/TERMINATIONS: 23 Socket, straight, .109" 24 Socket, straight, .140" 25 Socket, straight, .172"	
PLATING OPTIONS: 1 50 u" Au contacts		PLATING OPTIONS: 5 50 u" Au contacts; Sn/Pb alloy terminations <input checked="" type="checkbox"/> 8 50 u" Au contacts; Tin plated terminations	
HARDWARE			
STYLE OF HARDWARE: 00 None JC Turning jackscrews, captivated #0-80 UNF*		STYLE OF HARDWARE: 00 None TH Threaded hole, #0-80 UNF	
WIRING OPTIONS: XX See wiring codes, Page NA-2		WIRING OPTIONS: 00 None	

* = Recommended torque value 1.0 inch-lbs. max.
 Ball end hex wrench not recommended
 Hex wrench key/bit conforming to the requirements of ASME / ANSI-B-18.3 is recommended.
 .050" hex L-key long arm wrench - order AirBorn p/n CDG14148.

= Option not RoHS compliant



Recommended PC Board Layout

Vertical PTH Plug
FOR REFERENCE ONLY

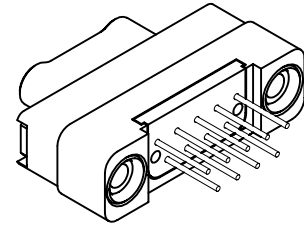
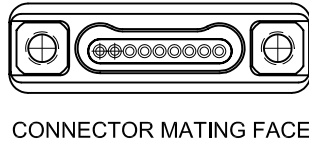

9 POSITION

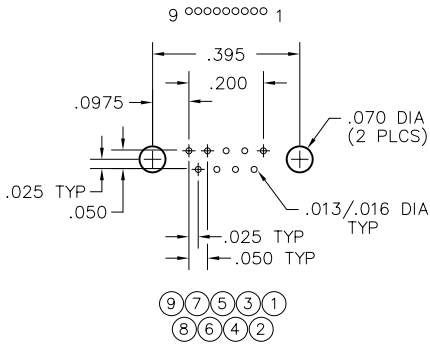

15 POSITION

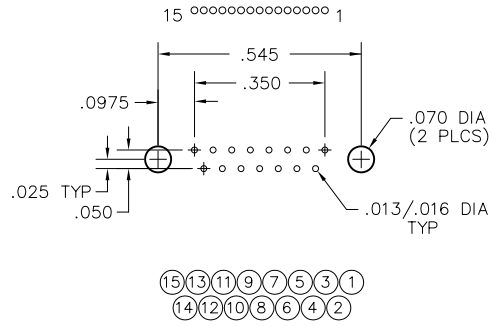

21 POSITION

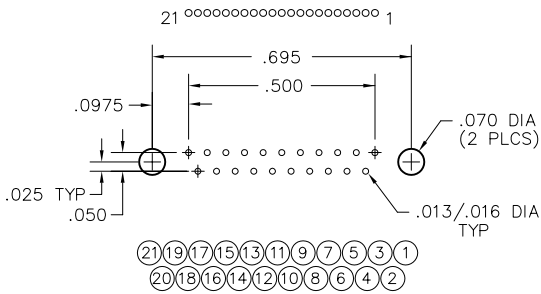

25 POSITION

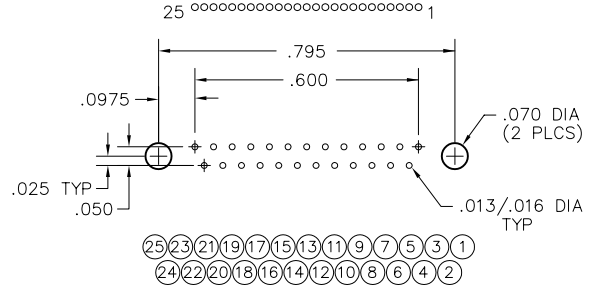

31 POSITION

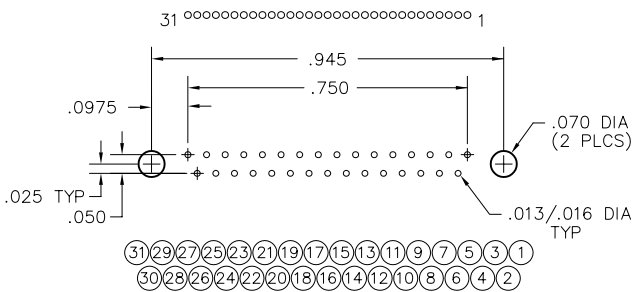

37 POSITION

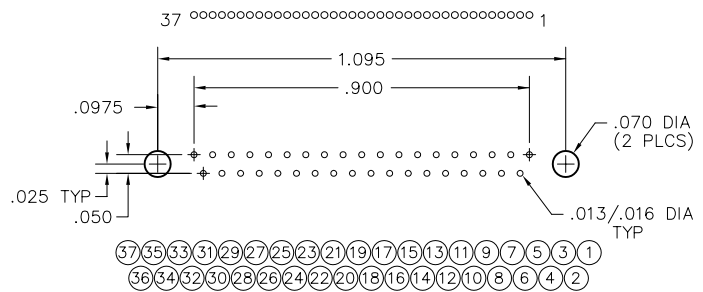

51 POSITION

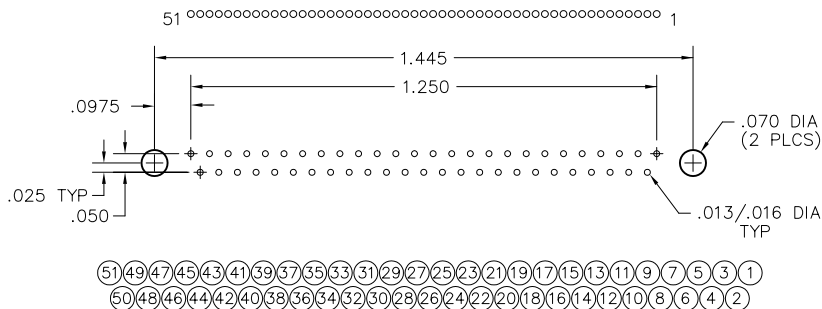

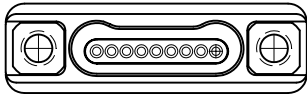

CONNECTOR MATING FACE

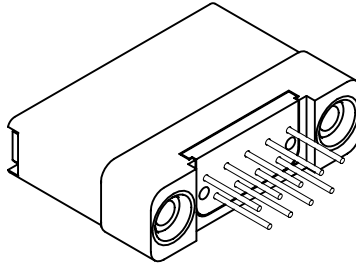

Recommended PC Board Layout

Vertical PTH Receptacle
FOR REFERENCE ONLY

9 POSITION

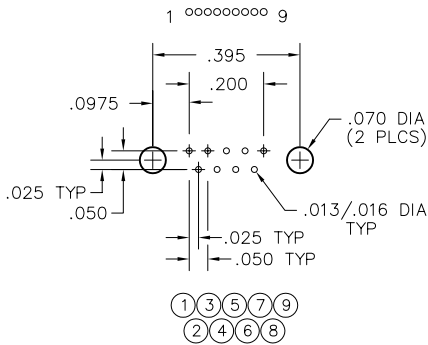

15 POSITION

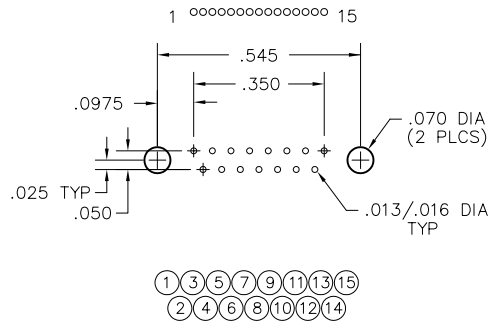

21 POSITION

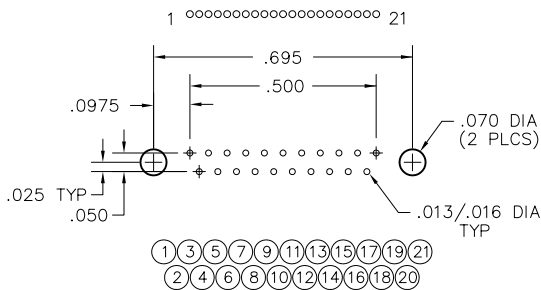

25 POSITION

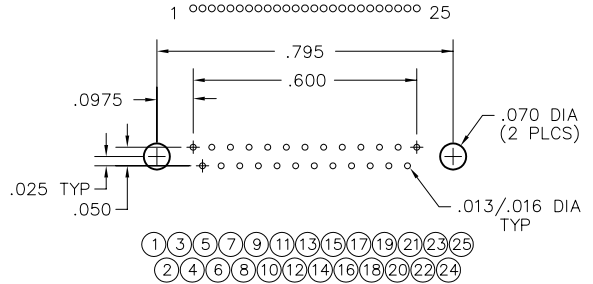

31 POSITION

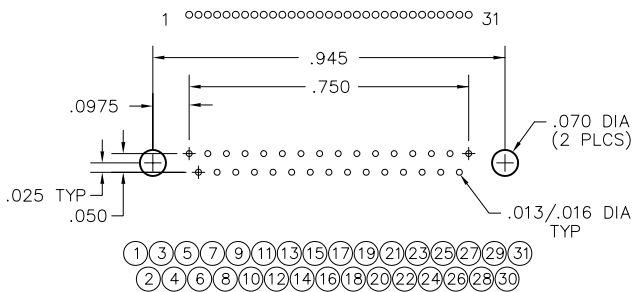

37 POSITION

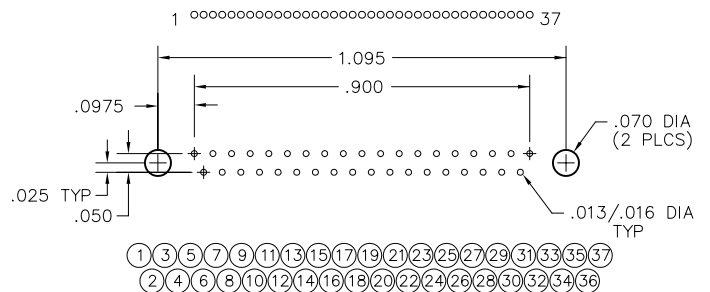

51 POSITION

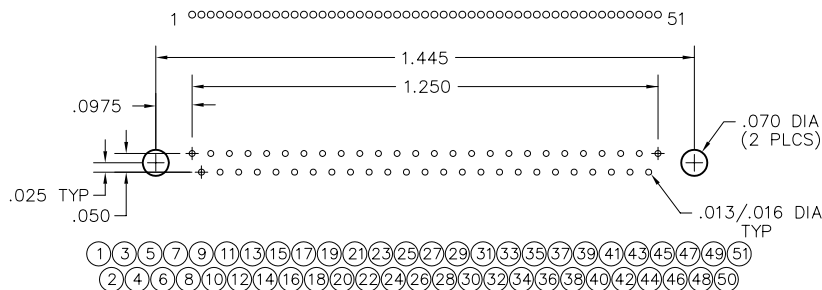

1 · ROW

Flex to Board Plug

.025"

NK, NK

9 thru 85 Contacts

NK-1E2-031-335-JC00
(METAL)

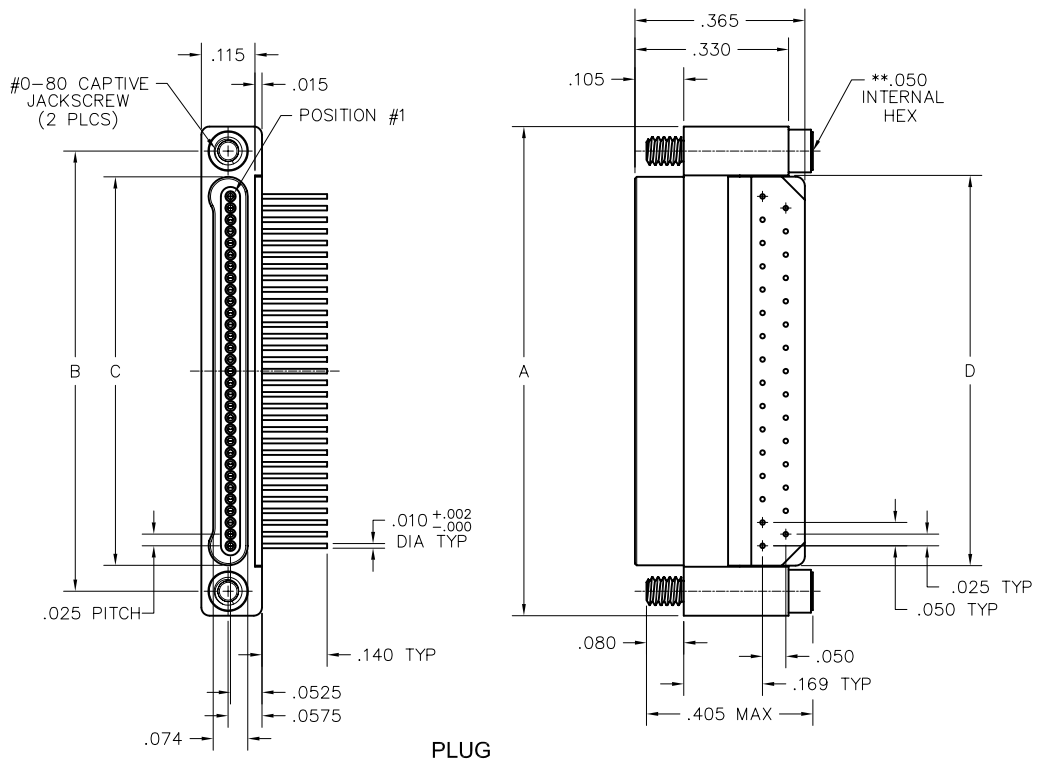
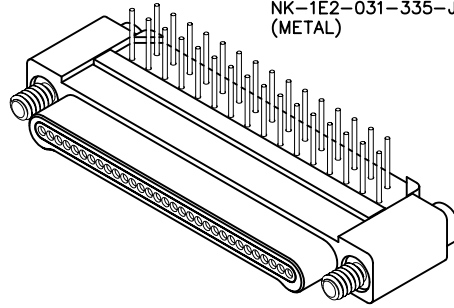

SIZE	A	B	C		D
			PLUG	RCPT	
9	.500	.395	.284	.285	.290
15	.650	.545	.434	.435	.440
21	.800	.695	.584	.585	.590
25	.900	.795	.684	.685	.690
31	1.050	.945	.834	.835	.840
37	1.200	1.095	.984	.985	.990
51	1.550	1.445	1.334	1.335	1.340

** = HEX MEASUREMENT TAKEN ACROSS THE FLATS.

PLUG: NK-1E2-031-335-JC00
 XX-XXX-XXX-XXX-XXXX

PLUG

SERIES

NK .025" Metal PC Board Mounted Connector

BODY

1 1-Row

BODY STYLE:

E Plug, right angle, plated thru hole (PTH)

BODY MATERIAL:

- 2 Liquid Crystal Polymer w/ electroless nickel shell
- 3 Liquid Crystal Polymer w/ electrodeposited cadmium shell

SIZE

XXX Number of contacts (009, 015, 021, 025, 031, 037 or 051)

CONTACTS

TYPE CONTACTS/TERMINATIONS:

- 32 Pin, right angle, .109"
- 33 Pin, right angle, .140"
- 34 Pin, right angle, .172"

PLATING OPTIONS:

- 5 50 u" Au contacts; Sn/Pb alloy terminations
- 8 50 u" Au contacts; Tin plated terminations

HARDWARE

STYLE OF HARDWARE:

- 00 None
- JC Turning jackscrews, captivated #0-80 UNF*

WIRING OPTIONS:

- 00 None

* = .050 hex key (#0-80 thread)
 Recommended torque value 1.0 inch-lbs. max. (#0-80 thread)
 Ball end hex wrench not recommended
 Hex wrench key/bit conforming to the requirements of ASME / ANSI-B-18.3 is recommended.
 .050" hex L-key long arm wrench - order AirBorn p/n CDG14148.

= Option not RoHS compliant



Recommended Flex Circuit Layout

Right Angle Flex Mount PTH Plug
FOR REFERENCE ONLY

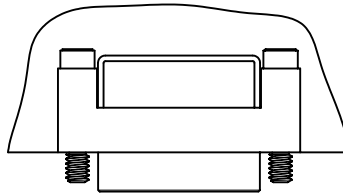

FLEX CIRCUIT LAYOUT
COMPONENT SIDE

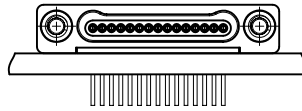
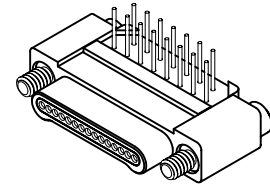

CONNECTOR MATING FACE

9 POSITION

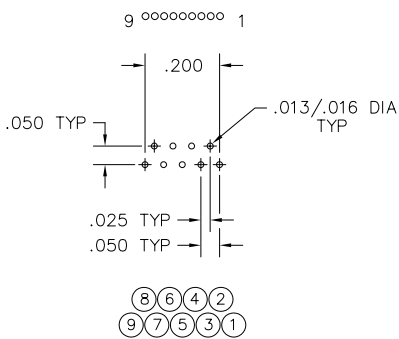

15 POSITION

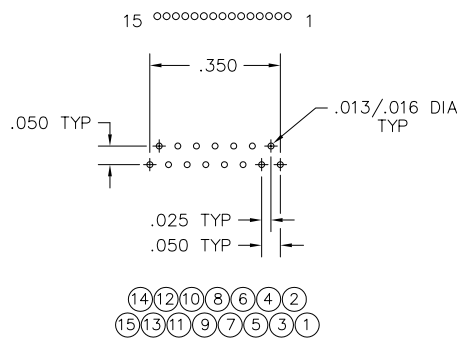

21 POSITION

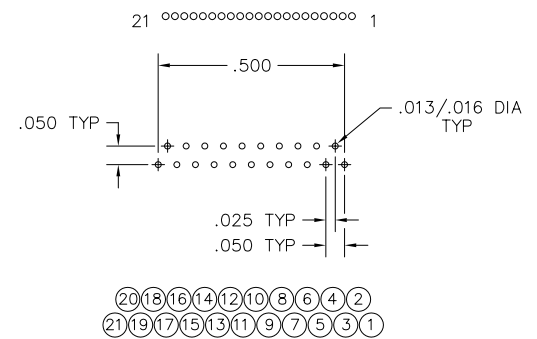

25 POSITION

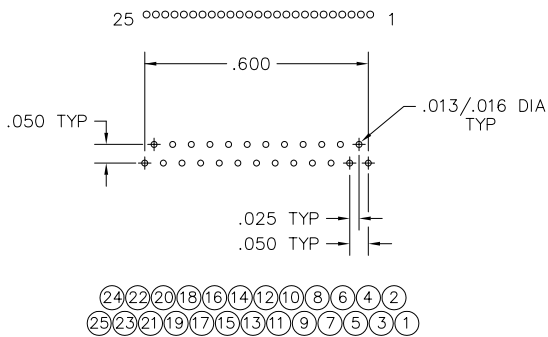

31 POSITION

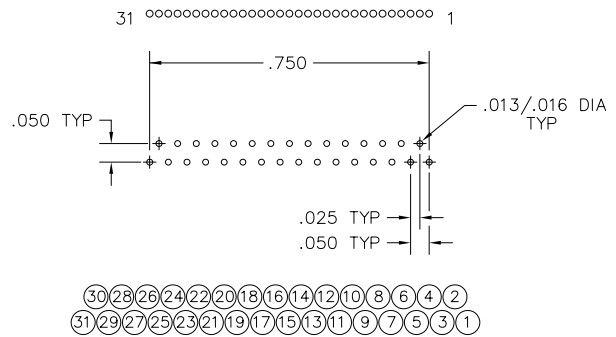

37 POSITION

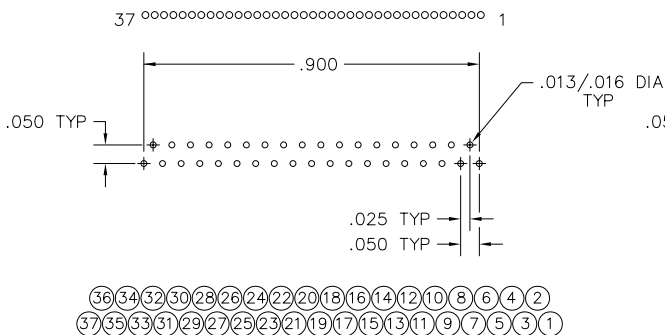

51 POSITION

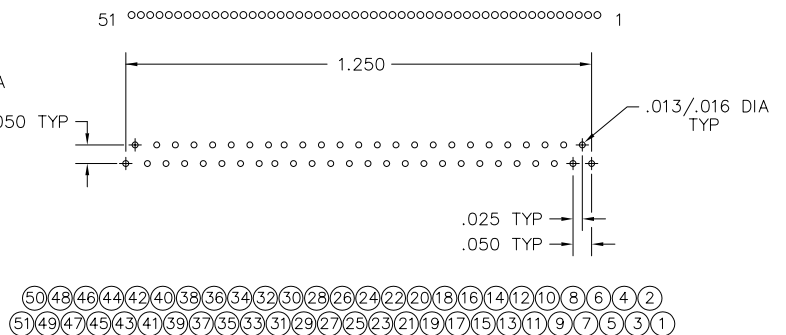

Call (972) 931-3200 · Fax (972) 931-9305 · www.AirBorn.com



2 · ROW Cable to Cable .025"

NM, NM

9 thru 91 Contacts

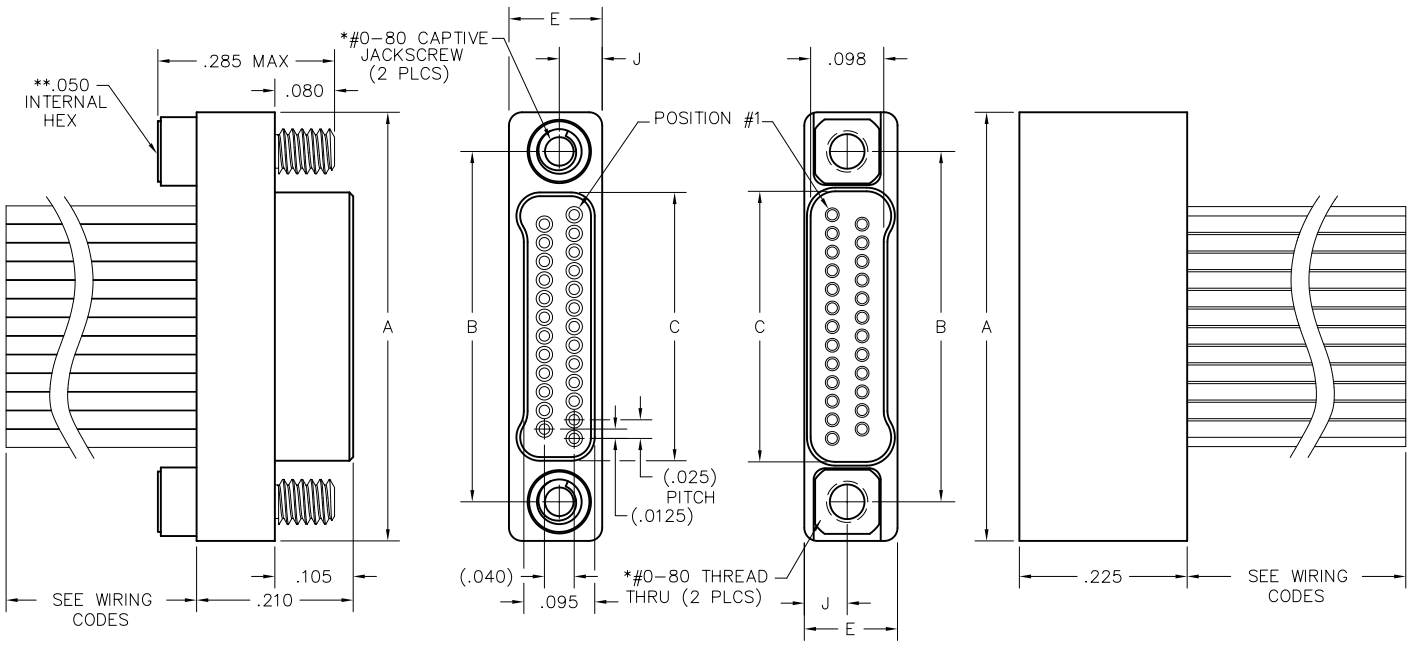
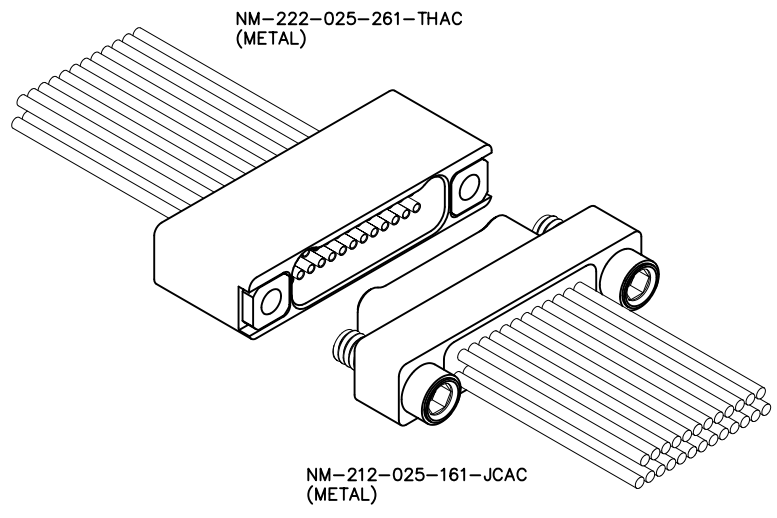

PLUG

RECEPTACLE

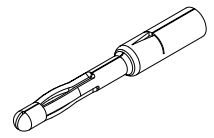

PIN CONTACT
3 TINE SPRING MEMBER, CRIMP

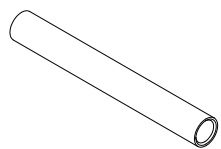

SOCKET CONTACT
DRAWN TUBE, CRIMP

SIZE	A	B	C		E	J	*HARDWARE
			PLUG	RCPT			
9	.375	.270	.160	.163	.125	.0575	#0-80 THREAD
15	.450	.345	.235	.238			
21	.525	.420	.310	.313			
25	.575	.470	.360	.363			
31	.650	.545	.435	.438			
37	.725	.620	.510	.513			
51	.900	.795	.685	.688			
65	1.075	.970	.860	.863	.150	.0700	#2-56 THREAD
69	1.125	1.020	.910	.913			
85	1.377	1.246	1.110	1.113			
91	1.452	1.321	1.185	1.195			

* = #2-56 UNC THREAD ON 85 AND 91 POSITION CONNECTORS.
 ** = 1/16" HEX ON 85 POSITION CONNECTORS. HEX MEASUREMENTS TAKEN ACROSS THE FLATS.

PLUG: NM-212-025-161-JCAC
RECEPTACLE: NM-222-025-261-THAC
 XX-XXX-XXX-XXX-XXXX

PLUG		RECEPTACLE	
SERIES			
NM	.025" Metal I/O Connector	NM	.025" Metal I/O Connector
BODY			
2	2-Row	2	2-Row
BODY STYLE:		BODY STYLE:	
1	Plug, straight	2	Receptacle, straight
5	Plug, straight, with factory installed backshell (See page NA-3)	6	Receptacle, straight, with factory installed backshell (See page NA-3)
BODY MATERIAL:		BODY MATERIAL:	
2	Liquid Crystal Polymer w/ electroless nickel shell	2	Liquid Crystal Polymer w/ electroless nickel shell
3	Liquid Crystal Polymer w/ electrodeposited cadmium shell <input checked="" type="checkbox"/>	3	Liquid Crystal Polymer w/ electrodeposited cadmium shell <input checked="" type="checkbox"/>
4	Liquid Crystal Polymer w/ stainless steel shell	4	Liquid Crystal Polymer w/ stainless steel shell
5	Liquid Crystal Polymer w/ titanium shell	5	Liquid Crystal Polymer w/ titanium shell
SIZE			
XXX	Number of contacts (009, 015, 021, 025, 031, 037, 051, 065, 069, 085 or 091)	XXX	Number of contacts (009, 015, 021, 025, 031, 037, 051, 065, 069, 085, or 091)
CONTACTS			
TYPE CONTACTS/TERMINATIONS:		TYPE CONTACTS/TERMINATIONS:	
16	Pin, straight, crimped wire	26	Socket, straight, crimped wire
PLATING OPTIONS:		PLATING OPTIONS:	
1	50 u" Au contacts	1	50 u" Au contacts
HARDWARE			
STYLE OF HARDWARE:		STYLE OF HARDWARE:	
00	None	00	None
JC	Turning jackscrews, captivated #0-80 UNF*	JC	Turning jackscrews, captivated #0-80 UNF* (body material 2 and 3 only)
TH	Threaded hole**, #0-80 UNF* (body material 2 and 3 only)	TH	Threaded hole**, #0-80 UNF*
WIRING OPTIONS:		WIRING OPTIONS:	
XX	See wiring codes, Page NA-2	XX	See wiring codes, Page NA-2

* = #2-56 UNC thread on 85 and 91 position connectors
 .050 hex key (#0-80 thread)
 1/16" hex key (#2-56 thread)
 Recommended torque value 1.0 inch-lbs. max. (#0-80 thread)
 Recommended torque value 2.0 inch-lbs. max. (#2-56 thread)
 Ball end hex wrench not recommended
 Hex wrench key/bit conforming to the requirements of ASME / ANSI-B-18.3 is recommended.
 .050" hex L-key long arm wrench - order AirBorn p/n CDG14148.
 1/16" hex L-key long arm wrench - order AirBorn p/n CDG14160.

** = Threaded hole tapped directly into stainless steel and titanium shells, aluminum shells have stainless steel inserts (as shown on previous page).

= Option not RoHS compliant

2 · ROW Cable to Cable (Jumper Assembly)

.025"

NM, NM

9 thru 85 Contacts

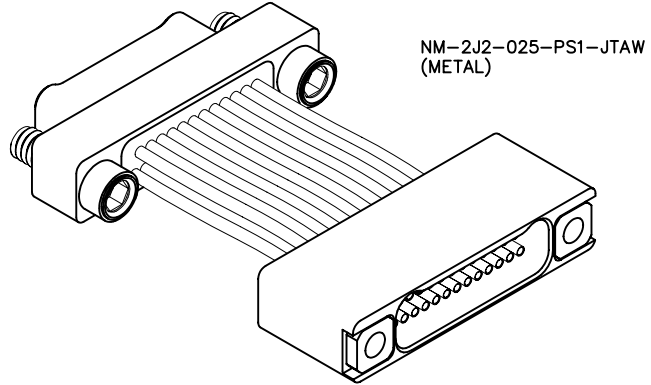

NM-2J2-025-PS1-JTAW
(METAL)

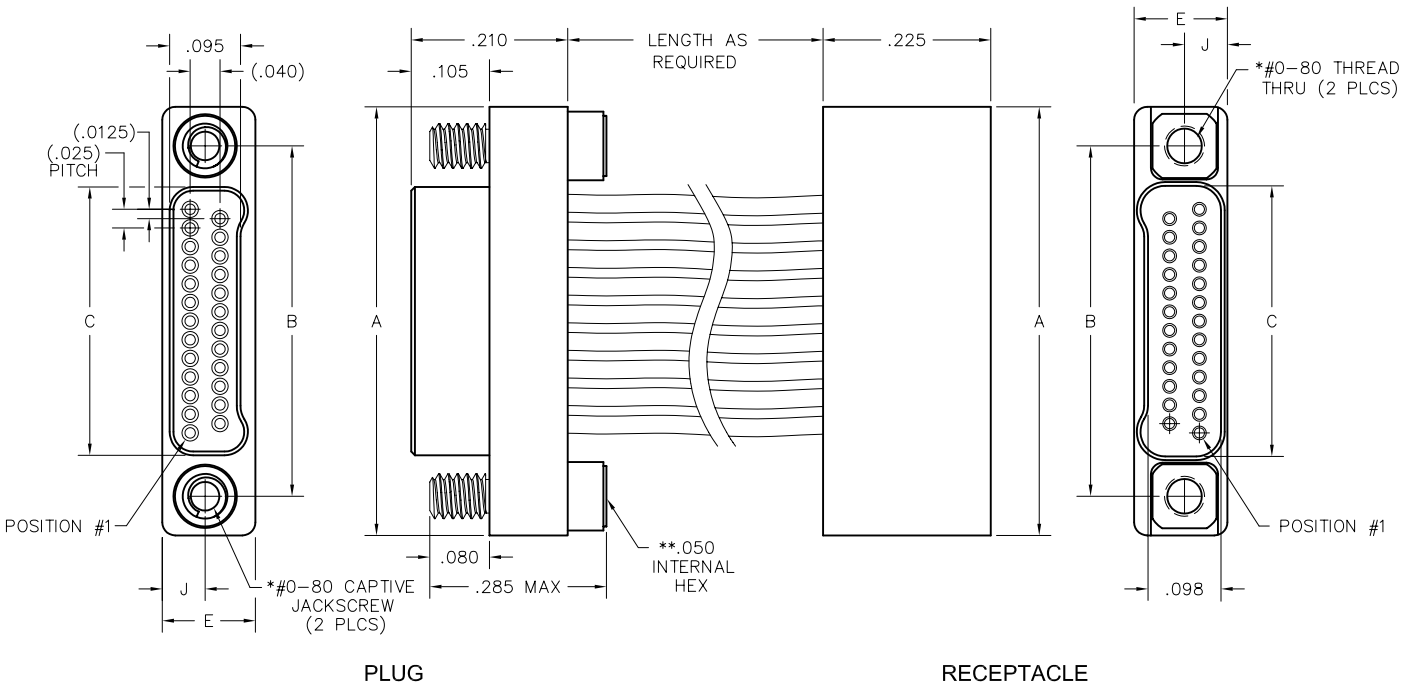

PLUG

RECEPTACLE

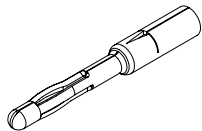

PIN CONTACT
3 TINE SPRING MEMBER, CRIMP

SIZE	A	B	C		E	J	*HARDWARE
			PLUG	RCPT			
9	.375	.270	.160	.163	.125	.0575	#0-80 THREAD
15	.450	.345	.235	.238			
21	.525	.420	.310	.313			
25	.575	.470	.360	.363			
31	.650	.545	.435	.438			
37	.725	.620	.510	.513			
51	.900	.795	.685	.688			
65	1.075	.970	.860	.863			
69	1.125	1.020	.910	.913			
85	1.377	1.246	1.110	1.113			

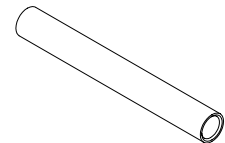

SOCKET CONTACT
DRAWN TUBE, CRIMP

* = #2-56 UNC THREAD ON 85 POSITION CONNECTORS.
** = 1/16" HEX ON 85 POSITION CONNECTORS. HEX MEASUREMENTS
TAKEN ACROSS THE FLATS.

NM-2J2-025-PS1-JTAW
XX-XXX-XXX-XXX-XXXX

SERIES	
NM	.025" Metal I/O Connector
BODY	
2	2-Row
BODY STYLE:	
J	Jumper assembly
BODY MATERIAL:	
2	Liquid Crystal Polymer with electroless nickel shell
3	Liquid Crystal Polymer with electrodeposited cadmium shell <input checked="" type="checkbox"/>
4	Liquid Crystal Polymer with stainless steel shell
5	Liquid Crystal Polymer with titanium shell
SIZE	
XXX	Number of contacts (009, 015, 021, 025, 031, 037, 051, 065, 069 or 085)
CONTACTS	
TYPE CONTACTS/TERMINATIONS:	
PP	Plug to plug
PS	Plug to receptacle
SS	Receptacle to receptacle
PLATING OPTIONS:	
1	50 μ" Au contacts
HARDWARE	
STYLE OF HARDWARE:	
00	None
JJ	Four #0-80 UNF* turning jackscrews, captivated, two on each connector***
JT	Two #0-80 UNF* turning jackscrews, captivated, on plug & two #0-80 UNF* threaded holes** on receptacle
JP	Two #0-80 UNF* turning jackscrews, captivated, on plug & two #0-80 UNF* threaded holes** on plug***
TJ	Two #0-80 UNF* threaded holes** on plug & two #0-80 UNF* turning jackscrews, captivated, on receptacle***
JR	Two #0-80 UNF* turning jackscrews, captivated, on receptacle & two #0-80 UNF* threaded holes** on receptacle***
TT	Four #0-80 UNF* threaded holes**, two on each connector***
POLARIZATION / WIRING:	
XX	For wiring codes, see page NA-2

* = #2-56 UNC thread on 85 position connectors

.050 hex key (#0-80 thread)

1/16" hex key (#2-56 thread)

Recommended torque value 1.0 inch-lbs. max. (#0-80 thread)

Recommended torque value 2.0 inch-lbs. max. (#2-56 thread)

Ball end hex wrench not recommended

Hex wrench key/bit conforming to the requirements of ASME / ANSI-B-18.3 is recommended.

.050" hex L-key long arm wrench - order AirBorn p/n CDG14148.

1/16" hex L-key long arm wrench - order AirBorn p/n CDG14160.

** = Threaded hole tapped directly into stainless steel and titanium shells, aluminum shells have stainless steel inserts (as shown on previous page).

*** = Body material 2 and 3 only

● Consult factory if jumpers require other than direct one to one connections.

= Option not RoHS compliant

2 · ROW Cable to Cable

.025"

NM, NM

9 thru 85 Contacts

NM-212-025-161-JCAC
(METAL)

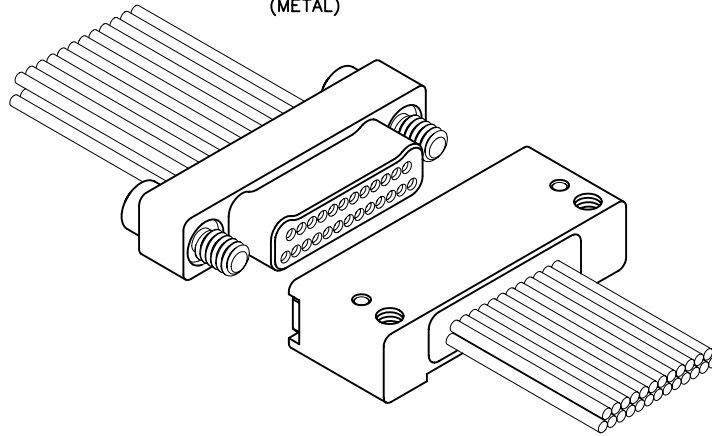

NM-242-025-261-THAC
(METAL)

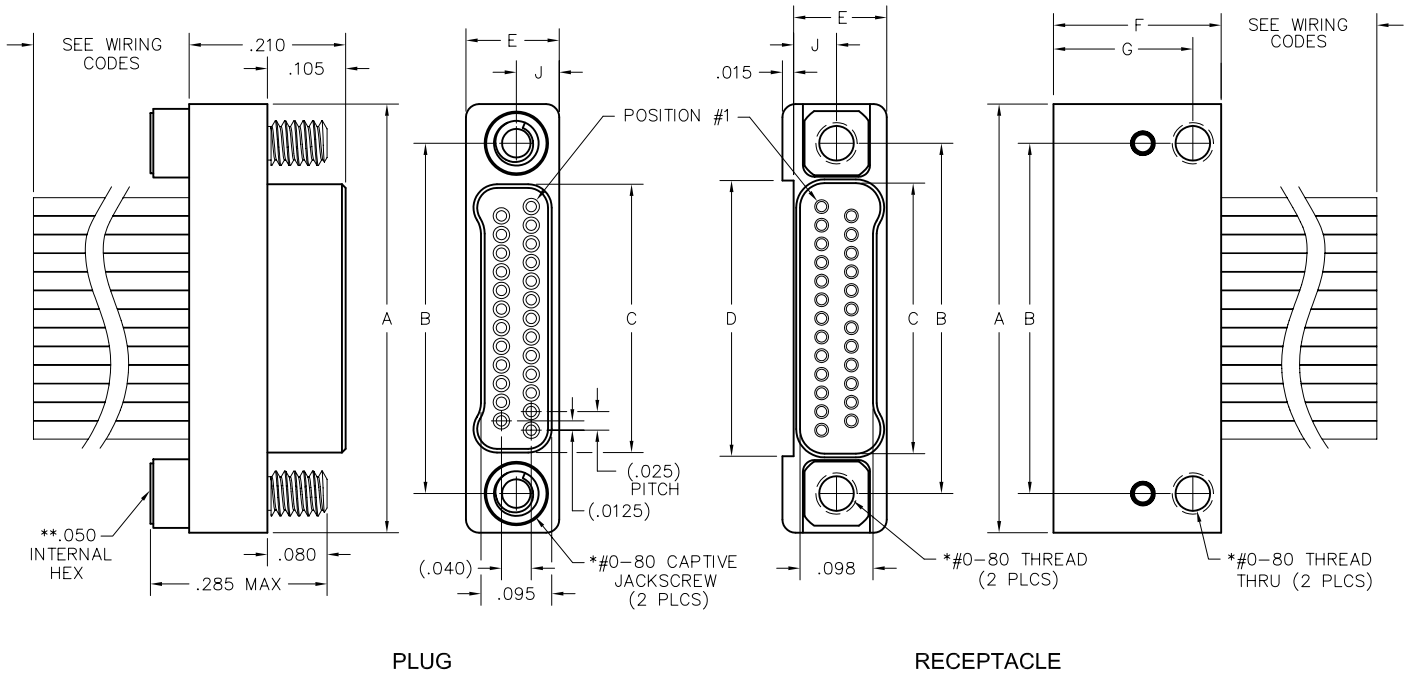

SIZE	DIMENSIONS		C		D	E	F	G	J	*HARDWARE
	A	B	PLUG	RCPT						
9	.375	.270	.160	.163	.170					
15	.450	.345	.235	.238	.245					
21	.525	.420	.310	.313	.320					
25	.575	.470	.360	.363	.370					
31	.650	.545	.435	.438	.445	.125	.225	.187	.0575	#0-80 THREAD
37	.725	.620	.510	.513	.520					
51	.900	.795	.685	.688	.695					
65	1.075	.970	.860	.863	.870					
69	1.125	1.020	.910	.913	.920					
85	1.377	1.246	1.110	1.113	1.120	.150	.270	.210	.0700	#2-56 THREAD

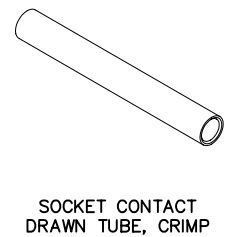
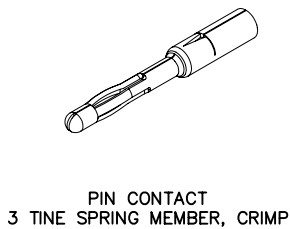

* = #2-56 UNC THREAD ON 85 POSITION CONNECTORS.
 ** = 1/16" HEX ON 85 POSITION CONNECTORS. HEX MEASUREMENTS TAKEN ACROSS THE FLATS.

PLUG: NM-212-025-161-JCAC
RECEPTACLE: NM-242-025-261-THAC
 XX-XXX-XXX-XXX-XXXX

PLUG		RECEPTACLE	
SERIES			
NM	.025" Metal I/O Connector	NM	.025" Metal I/O Connector
BODY			
2	2-Row	2	2-Row
BODY STYLE:		BODY STYLE:	
1	Plug, straight	4	Receptacle, straight with mounting holes
BODY MATERIAL:		BODY MATERIAL:	
2	Liquid Crystal Polymer w/ electroless nickel shell	2	Liquid Crystal Polymer w/ electroless nickel shell
3	Liquid Crystal Polymer w/ electrodeposited cadmium shell <input checked="" type="checkbox"/>	3	Liquid Crystal Polymer w/ electrodeposited cadmium shell <input checked="" type="checkbox"/>
SIZE			
XXX	Number of contacts (009, 015, 021, 025, 031, 037, 051, 065, 069, or 085)	XXX	Number of contacts (009, 015, 021, 025, 031, 037, 051, 065, 069, or 085)
CONTACTS			
TYPE CONTACTS/TERMINATIONS:		TYPE CONTACTS/TERMINATIONS:	
16	Pin, straight, crimped wire	26	Socket, straight, crimped wire
PLATING OPTIONS:		PLATING OPTIONS:	
1	50 u" Au contacts	1	50 u" Au contacts
HARDWARE			
STYLE OF HARDWARE:		STYLE OF HARDWARE:	
JC	Turning jackscrews, captivated #0-80 UNF*	TH	Threaded hole, #0-80 UNF*
WIRING OPTIONS:		WIRING OPTIONS:	
XX	See wiring codes, Page NA-2	XX	See wiring codes, Page NA-2

* = #2-56 UNC thread on 85 position connectors
 .050 hex key (#0-80 thread)
 1/16" hex key (#2-56 thread)
 Recommended torque value 1.0 inch-lbs. max. (#0-80 thread)
 Recommended torque value 2.0 inch-lbs. max. (#2-56 thread)
 Ball end hex wrench not recommended
 Hex wrench key/bit conforming to the requirements of ASME / ANSI-B-18.3 is recommended.
 .050" hex L-key long arm wrench - order AirBorn p/n CDG14148.
 1/16" hex L-key long arm wrench - order AirBorn p/n CDG14160.

= Option not ROHS compliant

2 · ROW Cable to Cable

.025"

NM, NM

9 thru 85 Contacts

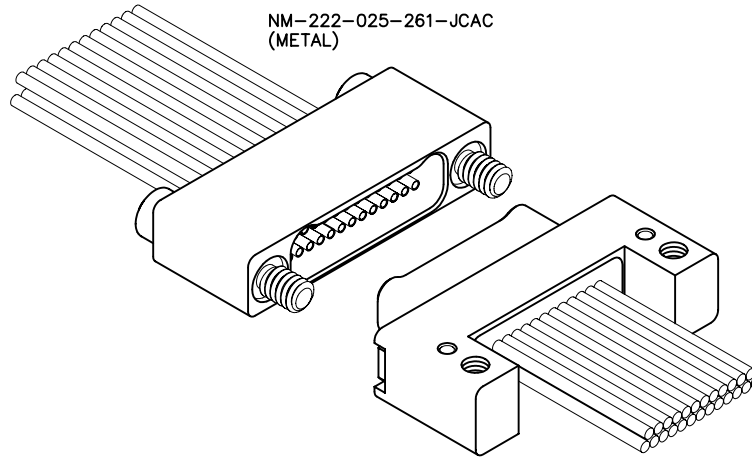

NM-222-025-261-JCAC
(METAL)

NM-232-025-161-THAC
(METAL)

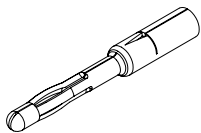
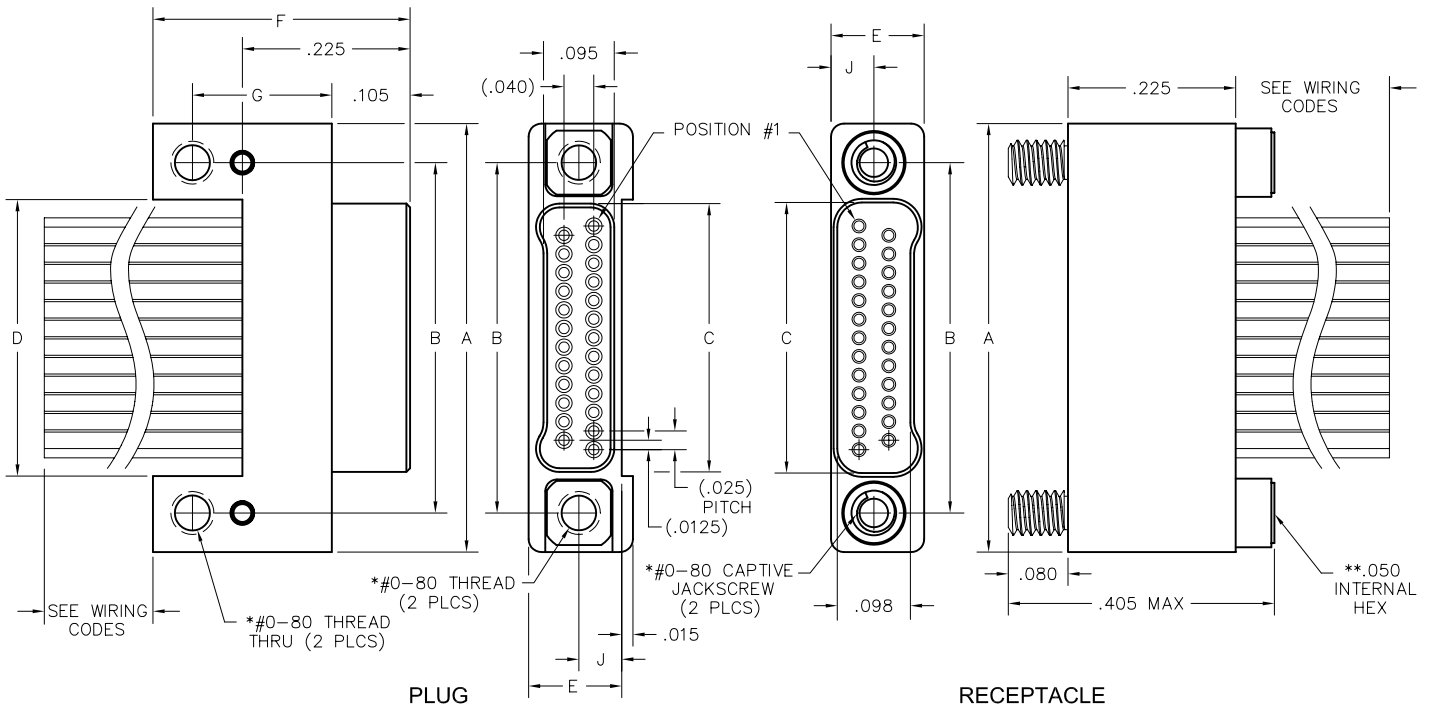

PIN CONTACT
3 TINE SPRING MEMBER, CRIMP

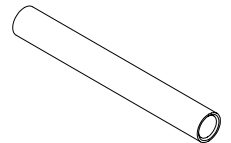

SOCKET CONTACT
DRAWN TUBE, CRIMP

SIZE	A	B	C		D	E	F	G	J	*HARDWARE
			PLUG	RCPT						
9	.375	.270	.160	.163	.170					
15	.450	.345	.235	.238	.245					
21	.525	.420	.310	.313	.320					
25	.575	.470	.360	.363	.370					
31	.650	.545	.435	.438	.445	.125	.345	.187	.0575	#0-80 THREAD
37	.725	.620	.510	.513	.520					
51	.900	.795	.685	.688	.695					
65	1.075	.970	.860	.863	.870					
69	1.125	1.020	.910	.913	.920					
85	1.377	1.246	1.110	1.113	1.120	.150	.375	.205	.0700	#2-56 THREAD

* = #2-56 UNC THREAD ON 85 POSITION CONNECTORS.
 ** = 1/16" HEX ON 85 POSITION CONNECTORS. HEX MEASUREMENTS TAKEN ACROSS THE FLATS.

PLUG: NM-232-025-161-THAC
RECEPTACLE: NM-222-025-261-JCAC
 XX-XXX-XXX-XXX-XXXX

PLUG		RECEPTACLE	
SERIES			
NM	.025" Metal I/O Connector	NM	.025" Metal I/O Connector
BODY			
2	2-Row	2	2-Row
BODY STYLE:		BODY STYLE:	
3	Plug, straight with mounting holes	2	Receptacle, straight
BODY MATERIAL:		BODY MATERIAL:	
2	Liquid Crystal Polymer w/ electroless nickel shell	2	Liquid Crystal Polymer w/ electroless nickel shell
3	Liquid Crystal Polymer w/ electrodeposited cadmium shell <input checked="" type="checkbox"/>	3	Liquid Crystal Polymer w/ electrodeposited cadmium shell <input checked="" type="checkbox"/>
SIZE			
XXX	Number of contacts (009, 015, 021, 025, 031, 037, 051, 065, 069, or 085)	XXX	Number of contacts (009, 015, 021, 025, 031, 037, 051, 065, 069, or 085)
CONTACTS			
TYPE CONTACTS/TERMINATIONS:		TYPE CONTACTS/TERMINATIONS:	
16	Pin, straight, crimped wire	26	Socket, straight, crimped wire
PLATING OPTIONS:		PLATING OPTIONS:	
1	50 u" Au contacts	1	50 u" Au contacts
HARDWARE			
STYLE OF HARDWARE:		STYLE OF HARDWARE:	
TH	Threaded hole, #0-80 UNF*	JC	Turning jackscrews, captivated #0-80 UNF*
WIRING OPTIONS:		WIRING OPTIONS:	
XX	See wiring codes, Page NA-2	XX	See wiring codes, Page NA-2

* = #2-56 UNC thread on 85 position connectors
 .050 hex key (#0-80 thread)
 1/16" hex key (#2-56 thread)
 Recommended torque value 1.0 inch-lbs. max. (#0-80 thread)
 Recommended torque value 2.0 inch-lbs. max. (#2-56 thread)
 Ball end hex wrench not recommended
 Hex wrench key/bit conforming to the requirements of ASME / ANSI-B-18.3 is recommended.
 .050" hex L-key long arm wrench - order AirBorn p/n CDG14148.
 1/16" hex L-key long arm wrench - order AirBorn p/n CDG14160.

= Option not ROHS compliant

2 · ROW Cable to Board Horizontal SMT

.025"

NM, NK

9 thru 91 Contacts

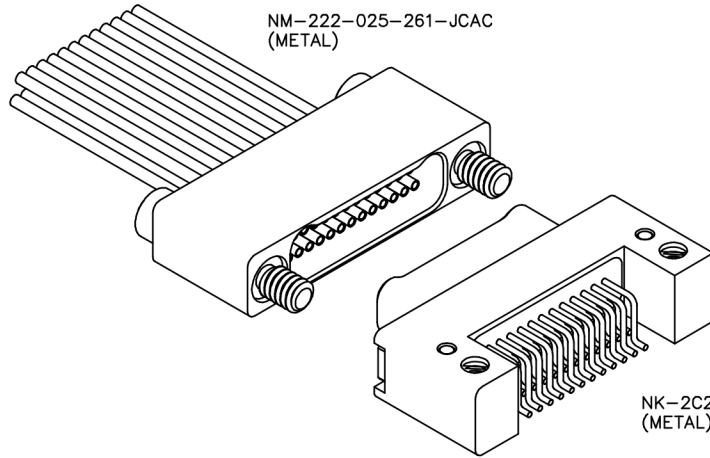

NM-222-025-261-JCAC
(METAL)

NK-2C2-025-125-TH00
(METAL)

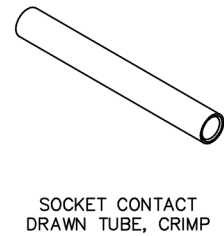
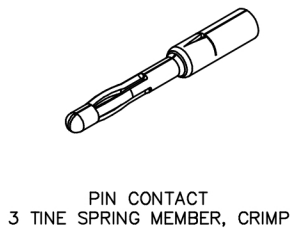
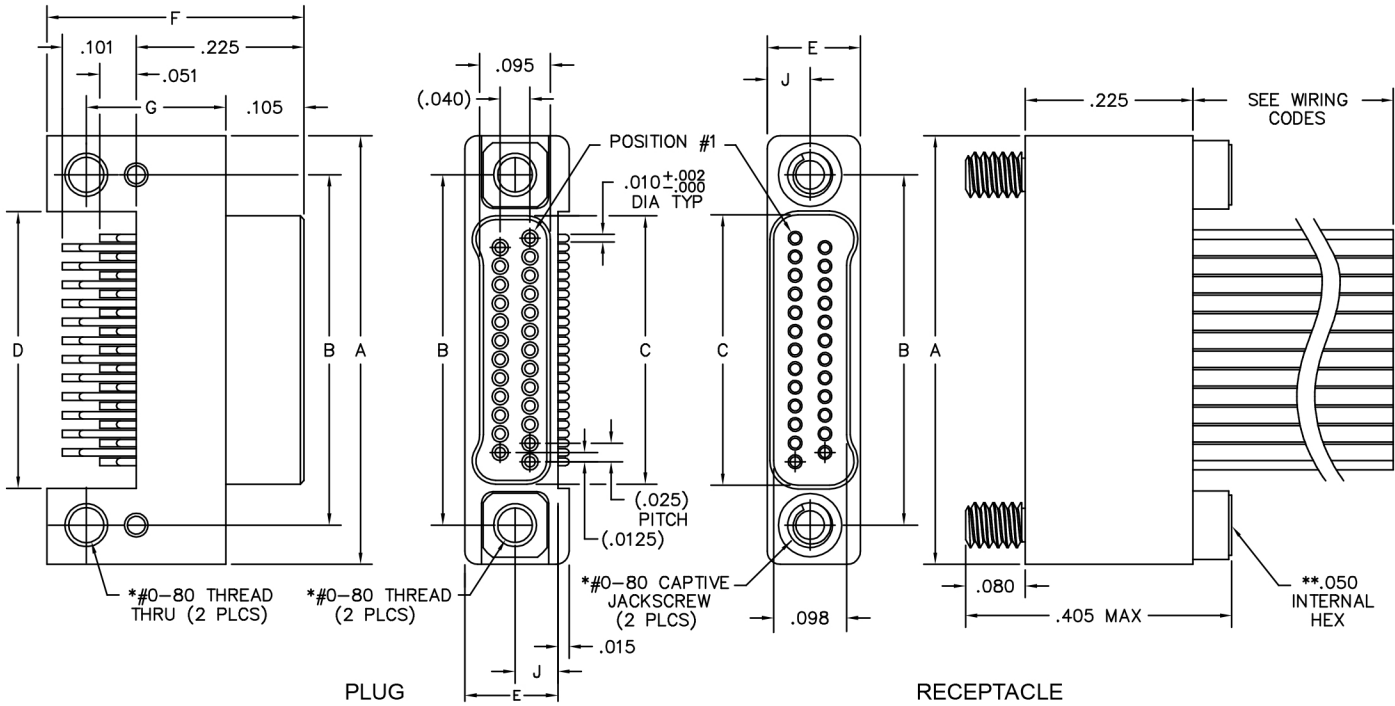

SIZE	A	B	C		D	E	F	G	J	*HARDWARE
			PLUG	RCPT						
9	.375	.270	.160	.163	.170					
15	.450	.345	.235	.238	.245					
21	.525	.420	.310	.313	.320					
25	.575	.470	.360	.363	.370					
31	.650	.545	.435	.438	.445	.125	.345	.187	.0575	#0-80 THREAD
37	.725	.620	.510	.513	.520					
51	.900	.795	.685	.688	.695					
65	1.075	.970	.860	.863	.870					
69	1.125	1.020	.910	.913	.920					
85	1.377	1.246	1.110	1.113	1.120	.150	.375	.205	.0700	#2-56 THREAD
91	1.452	1.321	1.185	1.188	1.195					

* = #2-56 UNC THREAD ON 85 POSITION CONNECTORS.
 ** = 1/16" HEX ON 85 POSITION CONNECTORS. HEX MEASUREMENTS
 TAKEN ACROSS THE FLATS.

PLUG: NK-2C2-025-125-TH00
RECEPTACLE: NM-222-025-261-JCAC
 XX-XXX-XXX-XXX-XXXX

PLUG

RECEPTACLE

SERIES

NK .025" Metal PC Board Mounted Connector | NM .025" Metal I/O Connector

BODY

2 2-Row BODY STYLE: C Plug, horizontal mount SMT BODY MATERIAL: 2 Liquid Crystal Polymer w/ electroless nickel shell 3 Liquid Crystal Polymer w/ electrodeposited cadmium shell <input checked="" type="checkbox"/>	2 2-Row BODY STYLE: 2 Receptacle, straight 6 Receptacle, straight, with factory installed backshell (See page NA-3) BODY MATERIAL: 2 Liquid Crystal Polymer w/ electroless nickel shell 3 Liquid Crystal Polymer w/ electrodeposited cadmium shell <input checked="" type="checkbox"/>
--	--

SIZE

XXX Number of contacts (009, 015, 021, 025, 031, 037, 051, 065, 069 or 085) | XXX Number of contacts (009, 015, 021, 025, 031, 037, 051, 065, 069 or 085)

CONTACTS

TYPE CONTACTS/TERMINATIONS: 12 Pin, SMT PLATING OPTIONS: 5 50 u" Au contacts; Sn/Pb alloy terminations <input checked="" type="checkbox"/> 8 50 u" Au contacts; Tin plated terminations	TYPE CONTACTS/TERMINATIONS: 26 Socket, straight, crimped wire PLATING OPTIONS: 1 50 u" Au contacts
---	---

HARDWARE

STYLE OF HARDWARE: 00 None TH Threaded hole, #0-80 UNF* WIRING OPTIONS: 00 None	STYLE OF HARDWARE: 00 None JC Turning jackscrews, captivated #0-80 UNF* WIRING OPTIONS: XX See wiring codes, Page NA-2
---	--

* = #2-56 UNC thread on 85 position connectors
 .050 hex key (#0-80 thread)
 1/16" hex key (#2-56 thread)
 Recommended torque value 1.0 inch-lbs. max. (#0-80 thread)
 Recommended torque value 2.0 inch-lbs. max. (#2-56 thread)
 Ball end hex wrench not recommended
 Hex wrench key/bit conforming to the requirements of ASME / ANSI-B-18.3 is recommended.
 .050" hex L-key long arm wrench - order AirBorn p/n CDG14148.
 1/16" hex L-key long arm wrench - order AirBorn p/n CDG14160.

= Option not RoHS compliant

2 · ROW Cable to Board Horizontal SMT

.025"

NM, NK

9 thru 85 Contacts

NM-212-025-161-JCAC
(METAL)

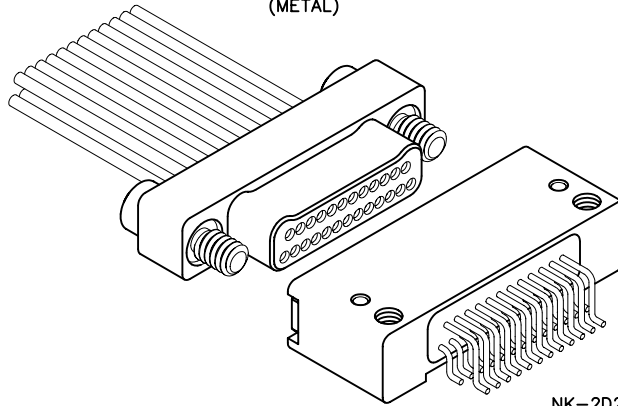

NK-2D2-025-225-TH00
(METAL)

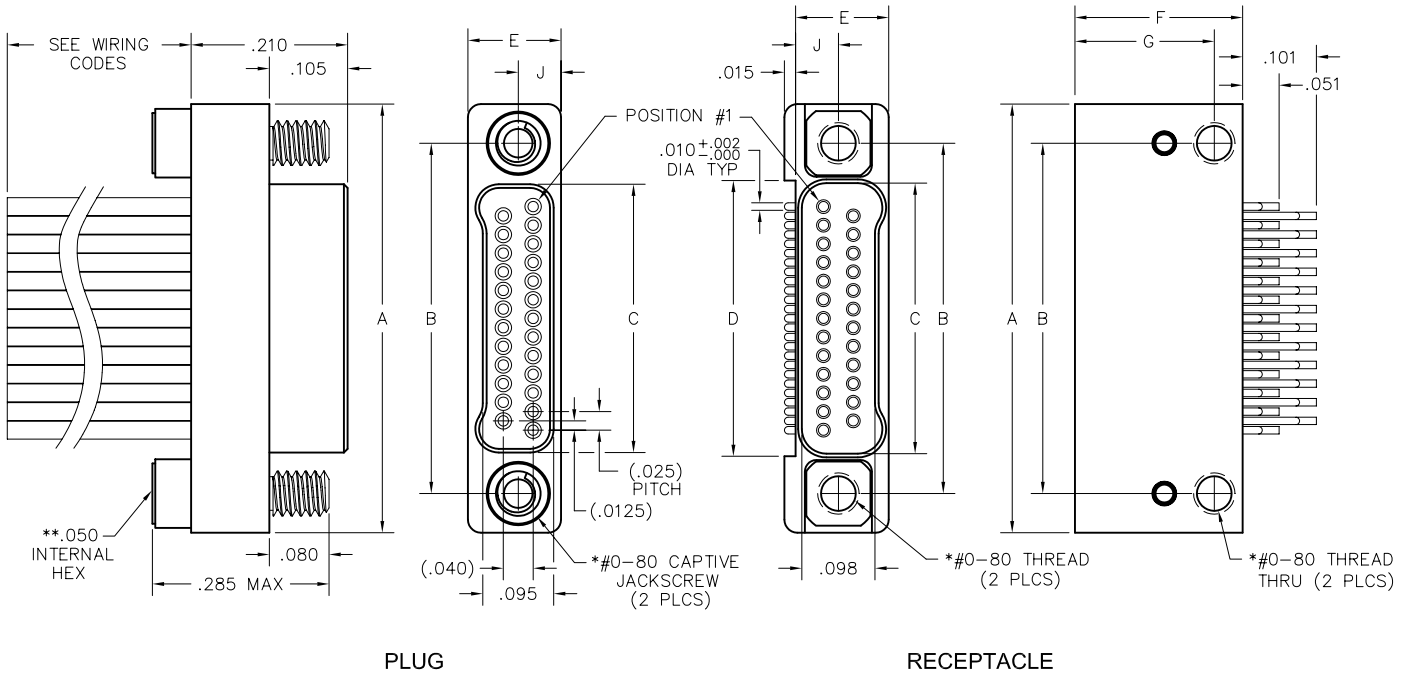

PLUG

RECEPTACLE

SIZE	A	B	C		D	E	F	G	J	*HARDWARE
			PLUG	RCPT						
9	.375	.270	.160	.163	.170					
15	.450	.345	.235	.238	.245					
21	.525	.420	.310	.313	.320					
25	.575	.470	.360	.363	.370					
31	.650	.545	.435	.438	.445	.125	.225	.187	.0575	#0-80 THREAD
37	.725	.620	.510	.513	.520					
51	.900	.795	.685	.688	.695					
65	1.075	.970	.860	.863	.870					
69	1.125	1.020	.910	.913	.920					
85	1.377	1.246	1.110	1.113	1.120	.150	.270	.210	.0700	#2-56 THREAD

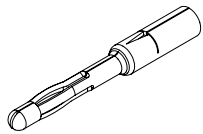

PIN CONTACT
3 TINE SPRING MEMBER, CRIMP

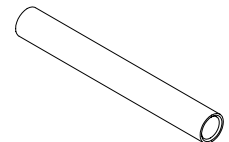

SOCKET CONTACT
DRAWN TUBE, CRIMP

* = #2-56 UNC THREAD ON 85 POSITION CONNECTORS.
** = 1/16" HEX ON 85 POSITION CONNECTORS. HEX MEASUREMENTS
TAKEN ACROSS THE FLATS.

PLUG: NM-212-025-161-JCAC
RECEPTACLE: NK-2D2-025-225-TH00
 XX-XXX-XXX-XXX-XXXX

PLUG		RECEPTACLE	
SERIES			
NM .025" Metal I/O Connector		NK .025" Metal PC Board Mounted Connector	
BODY			
2	2-Row	2	2-Row
BODY STYLE:		BODY STYLE:	
1	Plug, straight	D	Receptacle, horizontal mount SMT
5	Plug, straight, with factory installed backshell (See page NA-3)		
BODY MATERIAL:		BODY MATERIAL:	
2	Liquid Crystal Polymer w/ electroless nickel shell	2	Liquid Crystal Polymer w/ electroless nickel shell
3	Liquid Crystal Polymer w/ electrodeposited cadmium shell <input checked="" type="checkbox"/>	3	Liquid Crystal Polymer w/ electrodeposited cadmium shell <input checked="" type="checkbox"/>
SIZE			
XXX Number of contacts (009, 015, 021, 025, 031, 037, 051, 065, 069 or 085)		XXX Number of contacts (009, 015, 021, 025, 031, 037, 051, 065, 069 or 085)	
CONTACTS			
TYPE CONTACTS/TERMINATIONS:		TYPE CONTACTS/TERMINATIONS:	
16	Pin, straight, crimped wire	22	Socket, SMT
PLATING OPTIONS:		PLATING OPTIONS:	
1	50 u" Au contacts	5	50 u" Au contacts; Sn/Pb alloy terminations <input checked="" type="checkbox"/>
		8	50 u" Au contacts; Tin plated terminations
HARDWARE			
STYLE OF HARDWARE:		STYLE OF HARDWARE:	
00	None	00	None
JC	Turning jackscrews, captivated #0-80 UNF*	TH	Threaded hole, #0-80 UNF*
WIRING OPTIONS:		WIRING OPTIONS:	
XX	See wiring codes, Page NA-2	00	None

* = #2-56 UNC thread on 85 position connectors
 .050 hex key (#0-80 thread)
 1/16" hex key (#2-56 thread)
 Recommended torque value 1.0 inch-lbs. max. (#0-80 thread)
 Recommended torque value 2.0 inch-lbs. max. (#2-56 thread)
 Ball end hex wrench not recommended
 Hex wrench key/bit conforming to the requirements of ASME / ANSI-B-18.3 is recommended.
 .050" hex L-key long arm wrench - order AirBorn p/n CDG14148.
 1/16" hex L-key long arm wrench - order AirBorn p/n CDG14160.

= Option not RoHS compliant



Recommended PC Board Layout

Horizontal SMT Plug
FOR REFERENCE ONLY

No solder mask allowed within connector outline

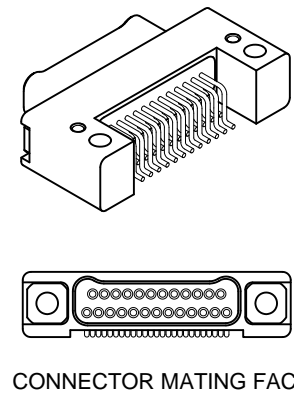
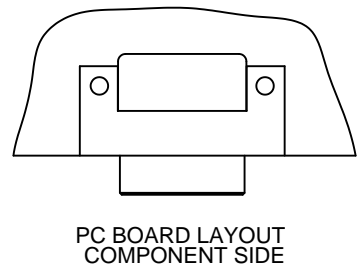
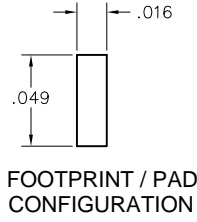

9 POSITION

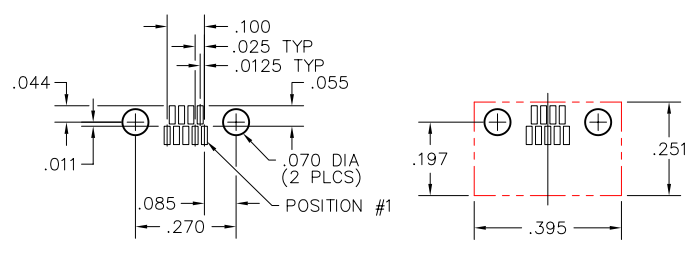

15 POSITION

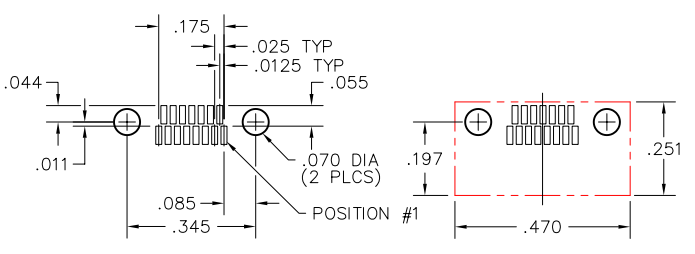
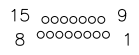

21 POSITION

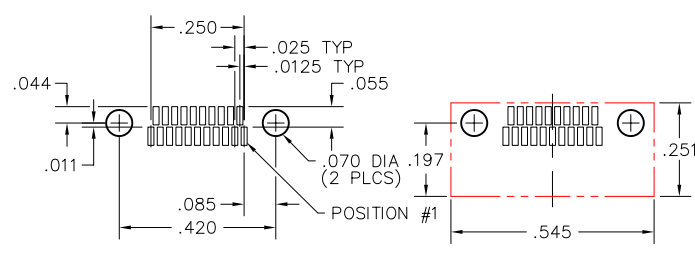
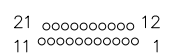

25 POSITION

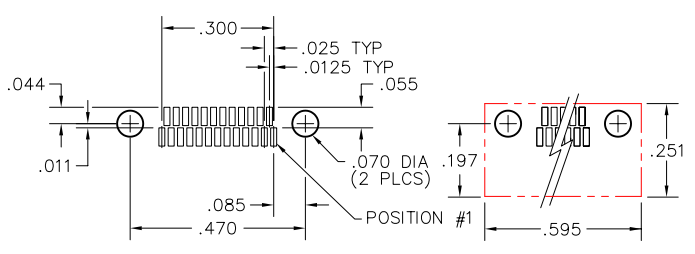
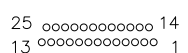

31 POSITION

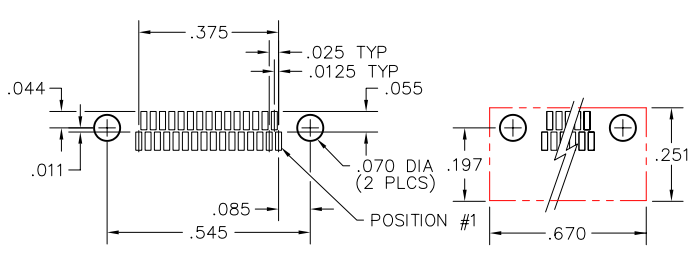
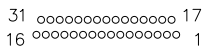

37 POSITION

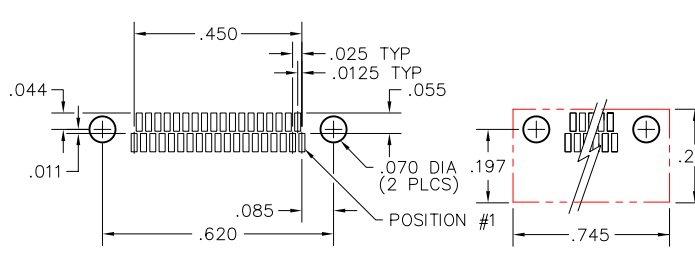
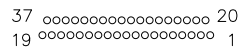

Recommended PC Board Layout

Horizontal SMT Plug
 .020 & .040 Lead Envelopes
 FOR REFERENCE ONLY

No solder mask allowed within connector outline

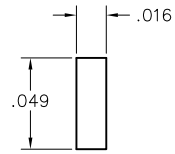

FOOTPRINT / PAD CONFIGURATION

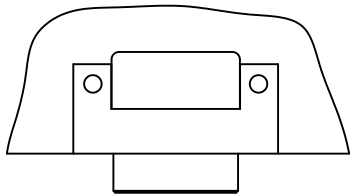

PC BOARD LAYOUT COMPONENT SIDE

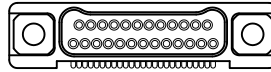
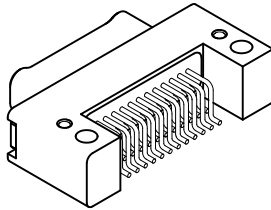

CONNECTOR MATING FACE

51 POSITION

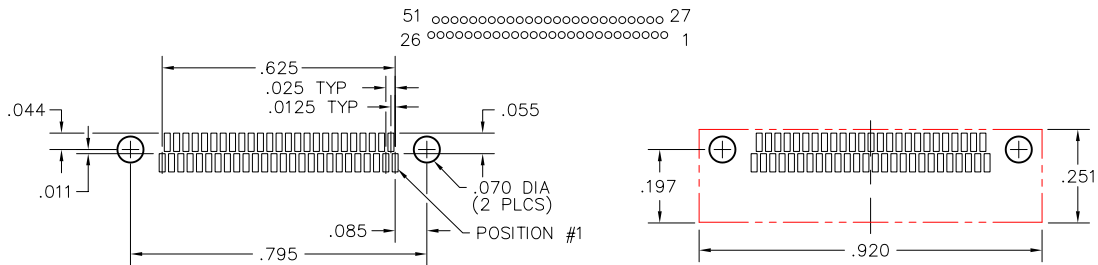

65 POSITION

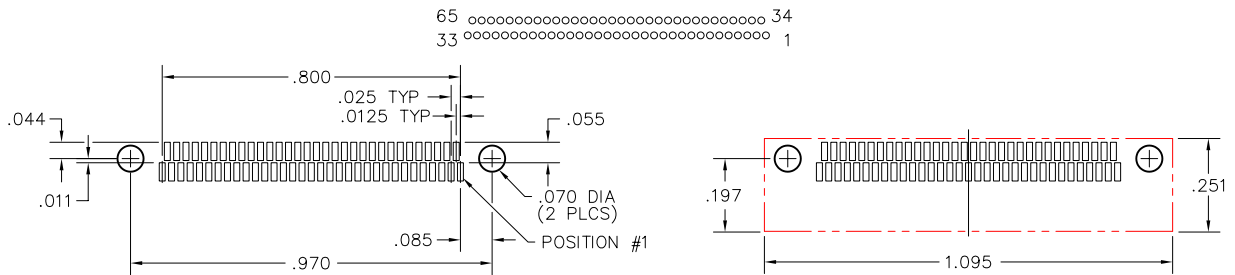

69 POSITION

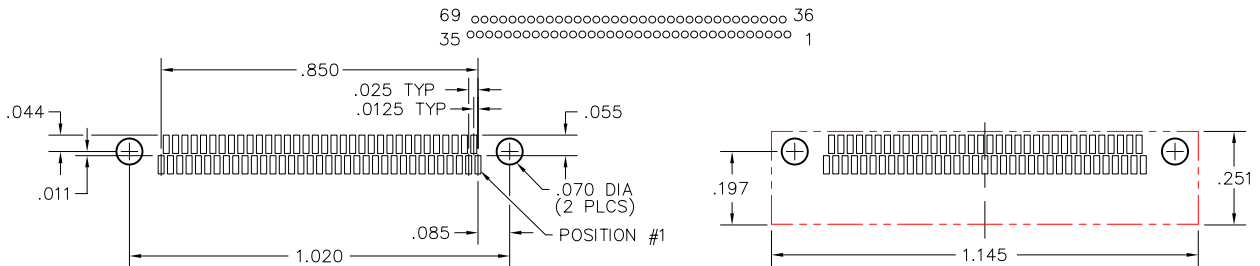

85 POSITION

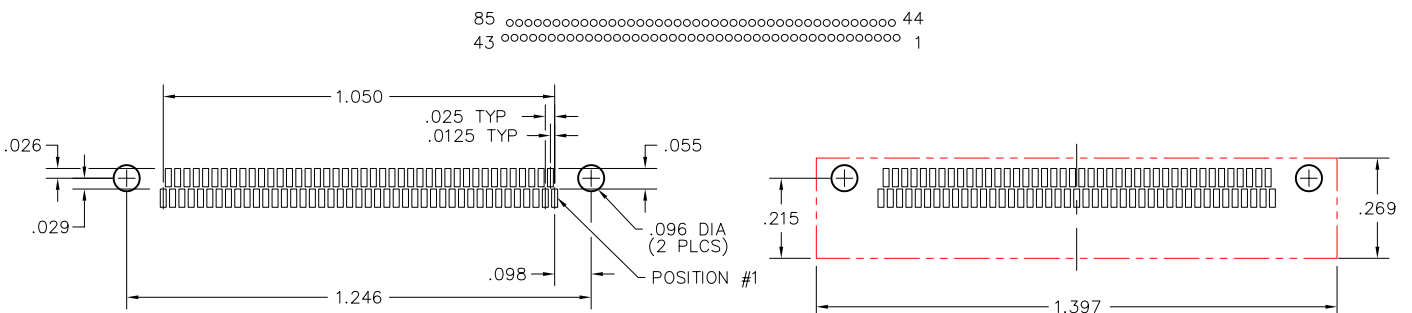



Recommended PC Board Layout

Horizontal SMT Receptacle
FOR REFERENCE ONLY

No solder mask allowed
within connector outline

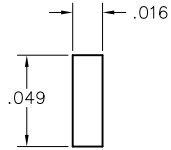

FOOTPRINT / PAD CONFIGURATION

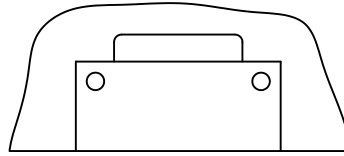

PC BOARD LAYOUT
COMPONENT SIDE

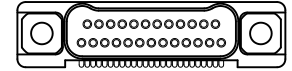
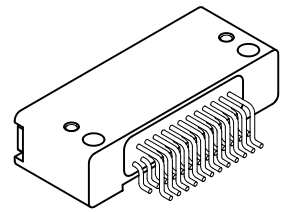

CONNECTOR MATING FACE

9 POSITION

6 0000 9
1 00000 5

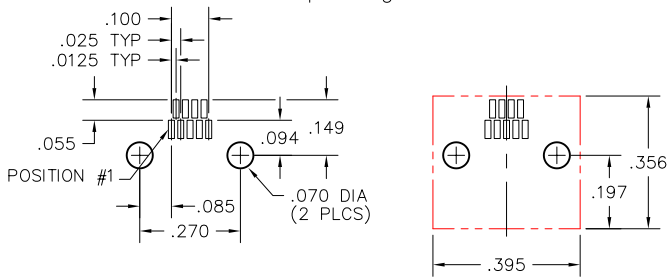

15 POSITION

9 000000 15
1 0000000 8

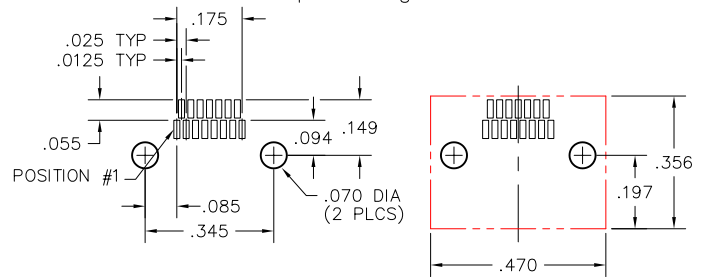

21 POSITION

12 00000000 21
1 000000000 11

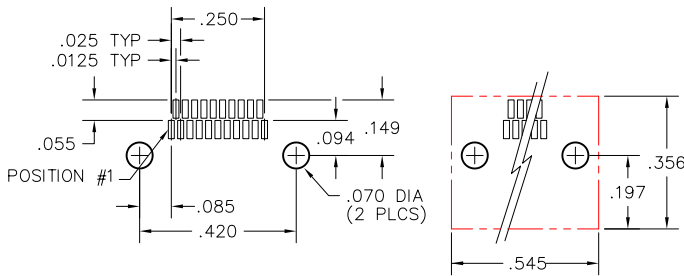

25 POSITION

14 000000000 25
1 0000000000 13

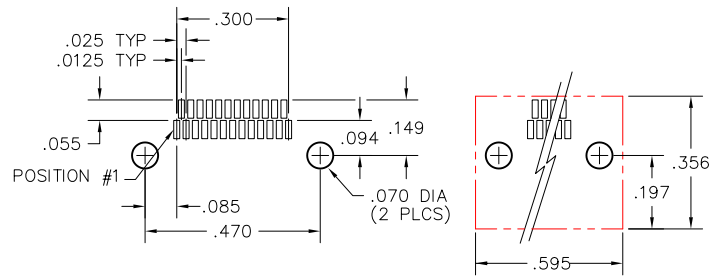

31 POSITION

17 00000000000 31
1 000000000000 16

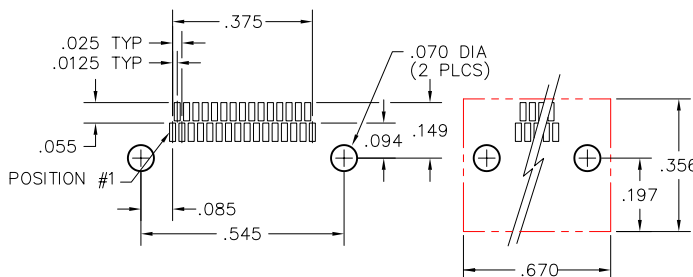

37 POSITION

20 0000000000000 37
1 00000000000000 19

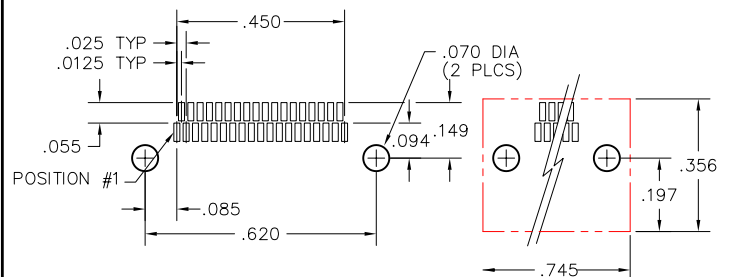

Recommended PC Board Layout

Horizontal SMT Receptacle
FOR REFERENCE ONLY

No solder mask allowed
within connector outline

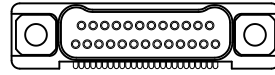
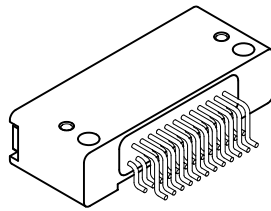
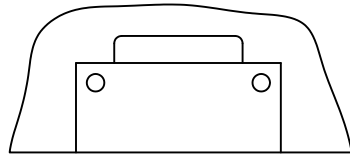
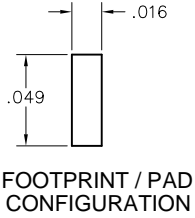

51 POSITION

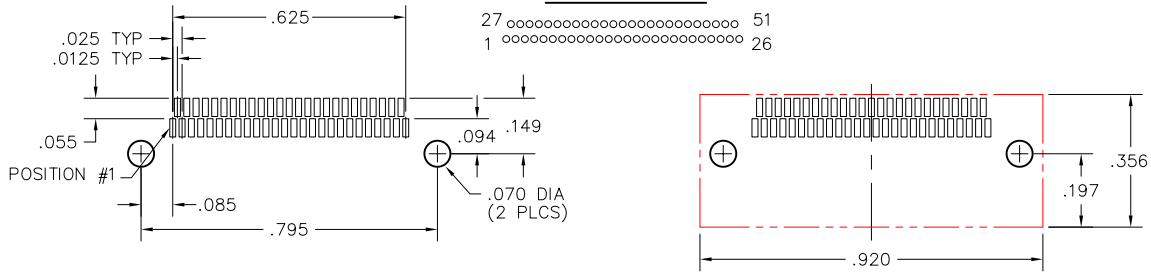

65 POSITION

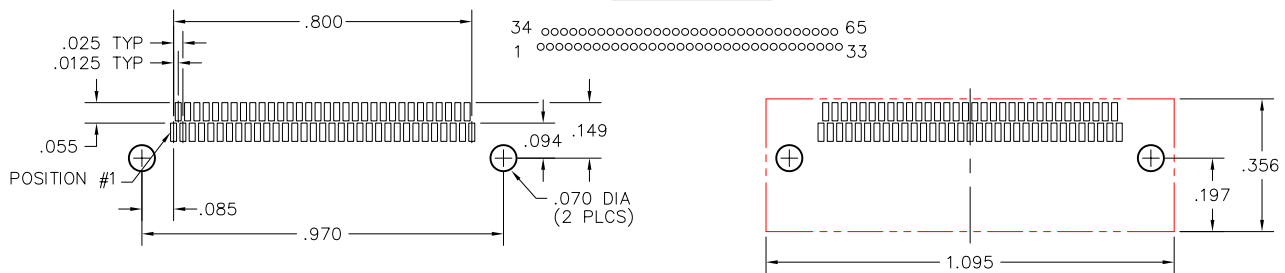

69 POSITION

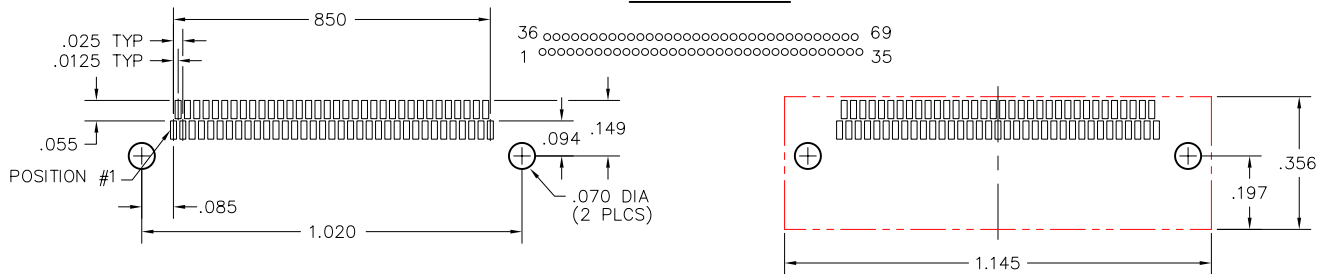

85 POSITION

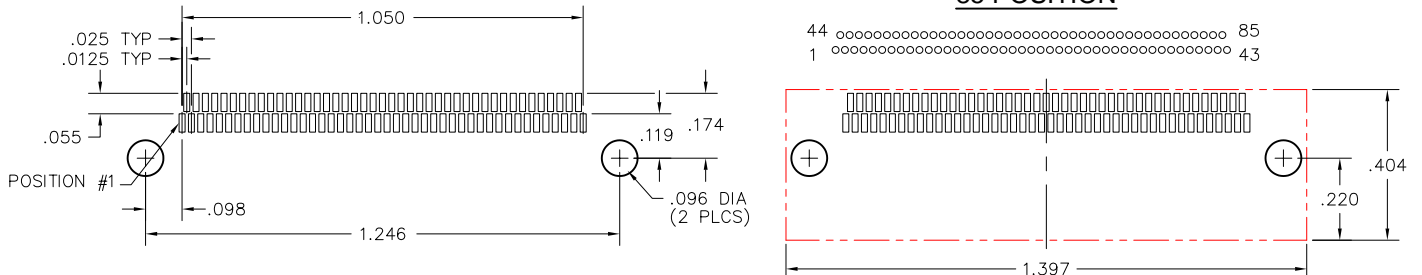

2 · ROW Cable to Board Vertical SMT

.025"

NM, NK

9 thru 91 Contacts

NM-222-025-261-JCAC
(METAL)

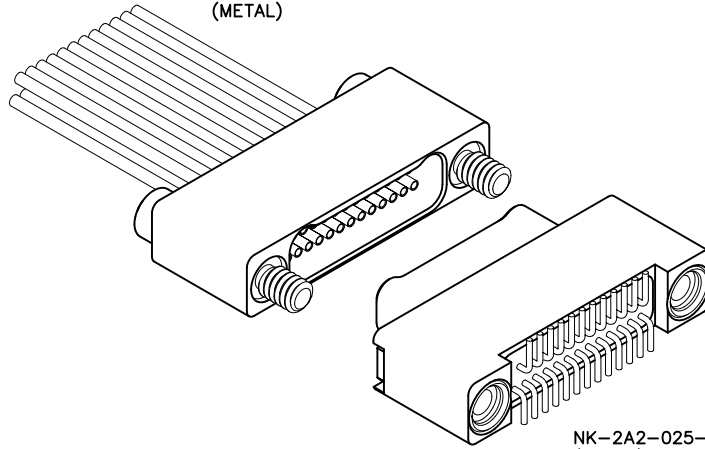

NK-2A2-025-125-TH00
(METAL)

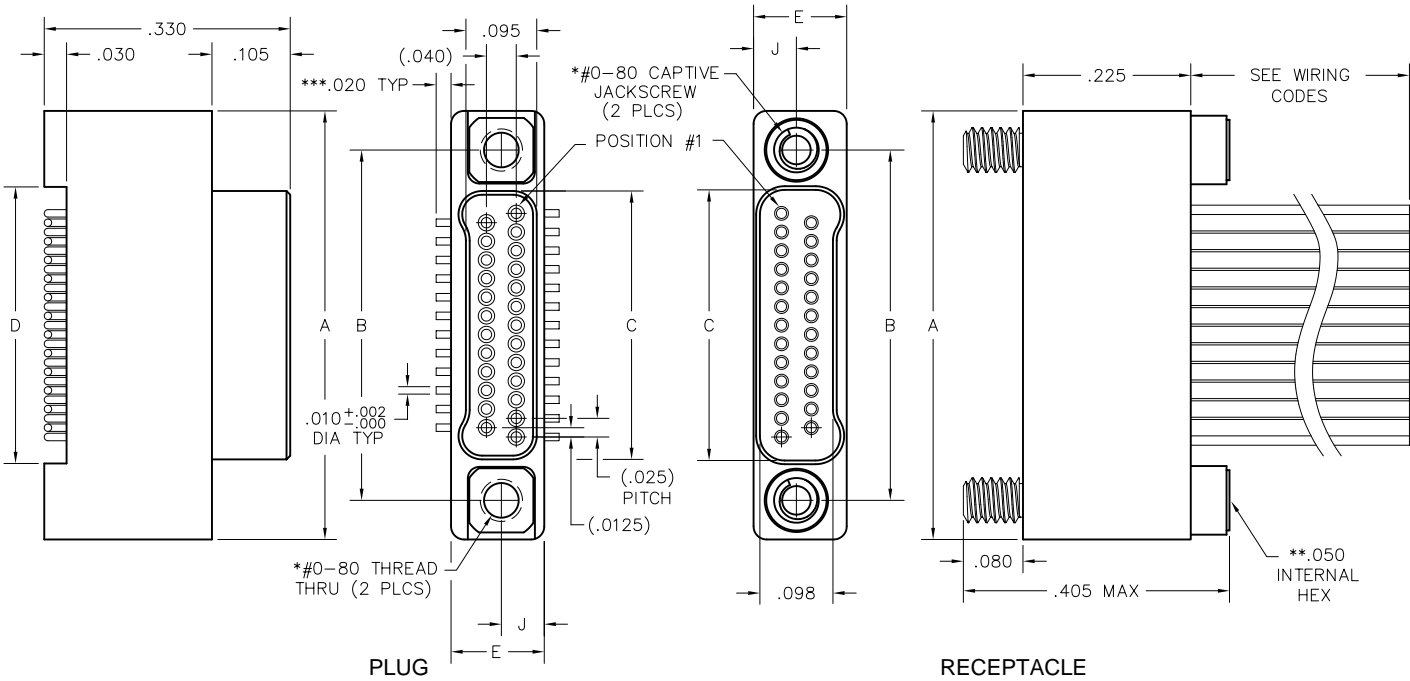

SIZE	A	B	C		D	E	J	*HARDWARE
			PLUG	RCPT				
9	.375	.270	.160	.163	.170			
15	.450	.345	.235	.238	.245			
21	.525	.420	.310	.313	.320			
25	.575	.470	.360	.363	.370			
31	.650	.545	.435	.438	.445	.125	.0575	#0-80 THREAD
37	.725	.620	.510	.513	.520			
51	.900	.795	.685	.688	.695			
65	1.075	.970	.860	.863	.870			
69	1.125	1.020	.910	.913	.920			
85	1.377	1.246	1.110	1.113	1.120	.150	.0700	#2-56 THREAD
91	1.457	1.321	1.185	1.188	1.195			

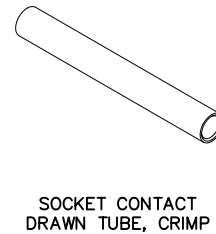
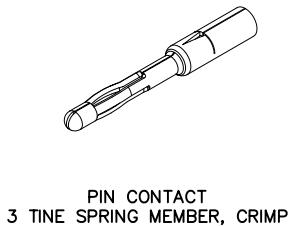

* = #2-56 UNC THREAD ON 85 AND 91 POSITION CONNECTORS.
 ** = 1/16" HEX ON 85 POSITION CONNECTORS. HEX MEASUREMENT TAKEN ACROSS THE FLATS.
 *** = DIMENSION CHANGES TO .040" FOR "010" OPTION. SEE PAGE N-48.

PLUG: NK-2A2-025-125-TH00
RECEPTACLE: NM-222-025-261-JCAC
 XX-XXX-XXX-XXX-XXXX-XXX

PLUG	RECEPTACLE
SERIES	

NK .025" Metal PC Board Mounted Connector	NM .025" Metal I/O Connector
---	------------------------------

BODY	
-------------	--

2 2-Row	2 2-Row
---------	---------

BODY STYLE: A Plug, vertical mount SMT	BODY STYLE: 2 Receptacle, straight 6 Receptacle, straight, with factory installed backshell (See page NA-3)
--	--

BODY MATERIAL: 2 Liquid Crystal Polymer w/ electroless nickel shell 3 Liquid Crystal Polymer w/ electrodeposited cadmium shell <input checked="" type="checkbox"/>	BODY MATERIAL: 2 Liquid Crystal Polymer w/ electroless nickel shell 3 Liquid Crystal Polymer w/ electrodeposited cadmium shell <input checked="" type="checkbox"/>
---	---

SIZE	
-------------	--

XXX Number of contacts (009, 015, 021, 025, 031, 037, 051, 065, 069, 085 or 091)	XXX Number of contacts (009, 015, 021, 025, 031, 037, 051, 065, 069, 085 or 091)
--	--

CONTACTS	
-----------------	--

TYPE CONTACTS/TERMINATIONS: 12 Pin, SMT (.020 lead envelope)	TYPE CONTACTS/TERMINATIONS: 26 Socket, straight, crimped wire
--	---

PLATING OPTIONS: 5 50 u" Au contacts; Sn/Pb alloy terminations <input checked="" type="checkbox"/> 8 50 u" Au contacts; Tin plated terminations	PLATING OPTIONS: 1 50 u" Au contacts
--	--

HARDWARE	
-----------------	--

STYLE OF HARDWARE: 00 None TH Threaded hole, #0-80 UNF*	STYLE OF HARDWARE: 00 None JC Turning jackscrews, captivated #0-80 UNF*
--	--

WIRING OPTIONS: 00 None	WIRING OPTIONS: XX See wiring codes, Page NA-2
-----------------------------------	--

OPTIONS	
----------------	--

010 .040 lead envelope	
------------------------	--

* = #2-56 UNC thread on 85 and 91 position connectors
 .050 hex key (#0-80 thread)
 1/16" hex key (#2-56 thread)
 Recommended torque value 1.0 inch-lbs. max. (#0-80 thread)
 Recommended torque value 2.0 inch-lbs. max. (#2-56 thread)
 Ball end hex wrench not recommended
 Hex wrench key/bit conforming to the requirements of ASME / ANSI-B-18.3 is recommended.
 .050" hex L-key long arm wrench - order AirBorn p/n CDG14148.
 1/16" hex L-key long arm wrench - order AirBorn p/n CDG14160.

= Option not RoHS compliant

2 · ROW Cable to Board Vertical SMT

.025"

NM, NK

9 thru 91 Contacts

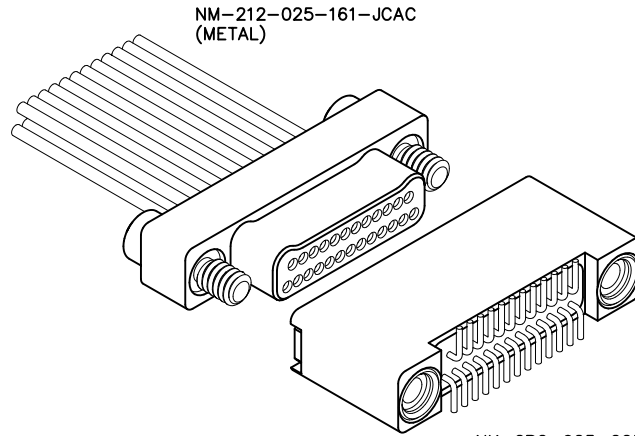

NK-2B2-025-225-TH00
(METAL)

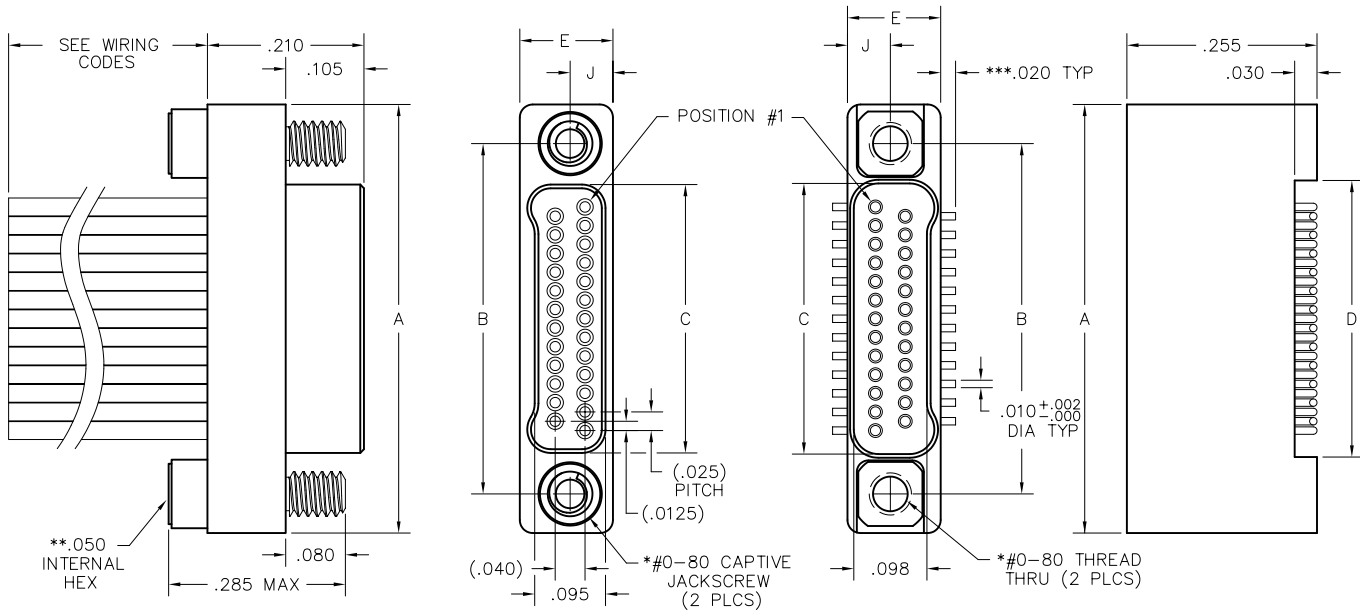

PLUG

RECEPTACLE

SIZE	A	B	C		D	E	J	*HARDWARE
			PLUG	RCPT				
9	.375	.270	.160	.163	.170			
15	.450	.345	.235	.238	.245			
21	.525	.420	.310	.313	.320			
25	.575	.470	.360	.363	.370			
31	.650	.545	.435	.438	.445	.125	.0575	#0-80 THREAD
37	.725	.620	.510	.513	.520			
51	.900	.795	.685	.688	.695			
65	1.075	.970	.860	.863	.870			
69	1.125	1.020	.910	.913	.920			
85	1.377	1.246	1.110	1.113	1.120	.150	.0700	#2-56 THREAD
91	1.457	1.321	1.185	1.188	1.195			

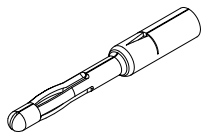

PIN CONTACT
3 TINE SPRING MEMBER, CRIMP

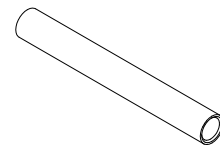

SOCKET CONTACT
DRAWN TUBE, CRIMP

* = #2-56 UNC THREAD ON 85 AND 91 POSITION CONNECTORS.
 ** = 1/16" HEX ON 85 POSITION CONNECTORS. HEX MEASUREMENT TAKEN ACROSS THE FLATS.
 *** = DIMENSION CHANGES TO .040" FOR "010" OPTION. SEE PAGE N-50.

PLUG: NM-212-025-161-JCAC
RECEPTACLE: NK-2B2-025-225-TH00
 XX-XXX-XXX-XXX-XXXX-XXX

PLUG		RECEPTACLE	
SERIES			
NM	.025" Metal I/O Connector	NK	.025" Metal PC Board Mounted Connector

BODY			
2	2-Row	2	2-Row
BODY STYLE: 1 Plug, straight 5 Plug, straight, with factory installed backshell (See page NA-3)		BODY STYLE: B Receptacle, vertical mount SMT	
BODY MATERIAL: 2 Liquid Crystal Polymer w/ electroless nickel shell 3 Liquid Crystal Polymer w/ electrodeposited cadmium shell <input checked="" type="checkbox"/>		BODY MATERIAL: 2 Liquid Crystal Polymer w/ electroless nickel shell 3 Liquid Crystal Polymer w/ electrodeposited cadmium shell <input checked="" type="checkbox"/>	

SIZE			
XXX	Number of contacts (009, 015, 021, 025, 031, 037, 051, 065, 069, 085 or 091)	XXX	Number of contacts (009, 015, 021, 025, 031, 037, 051, 065, 069, 085 or 091)

CONTACTS			
TYPE CONTACTS/TERMINATIONS: 16 Pin, straight, crimped wire		TYPE CONTACTS/TERMINATIONS: 22 Socket, SMT (.020 lead envelope)	
PLATING OPTIONS: 1 50 u" Au contacts		PLATING OPTIONS: 5 50 u" Au contacts; Sn/Pb alloy terminations <input checked="" type="checkbox"/> 8 50 u" Au contacts; Tin plated terminations	

HARDWARE			
STYLE OF HARDWARE: 00 None JC Turning jackscrews, captivated #0-80 UNF*		STYLE OF HARDWARE: 00 None TH Threaded hole, #0-80 UNF*	
WIRING OPTIONS: XX See wiring codes, Page NA-2		WIRING OPTIONS: 00 None	

OPTIONS	
	010 .040 lead envelope

* = #2-56 UNC thread on 85 and 91 position connectors
 .050 hex key (#0-80 thread)
 1/16" hex key (#2-56 thread)
 Recommended torque value 1.0 inch-lbs. max. (#0-80 thread)
 Recommended torque value 2.0 inch-lbs. max. (#2-56 thread)
 Ball end hex wrench not recommended
 Hex wrench key/bit conforming to the requirements of ASME / ANSI-B-18.3 is recommended.
 .050" hex L-key long arm wrench - order AirBorn p/n CDG14148.
 1/16" hex L-key long arm wrench - order AirBorn p/n CDG14160.

= Option not RoHS compliant



Recommended PC Board Layout

Vertical SMT Plug
 .020 & .040 Lead Envelopes
 FOR REFERENCE ONLY

No solder mask allowed
 within connector outline

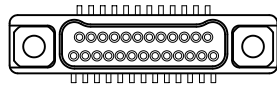
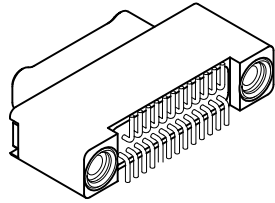

CONNECTOR MATING FACE

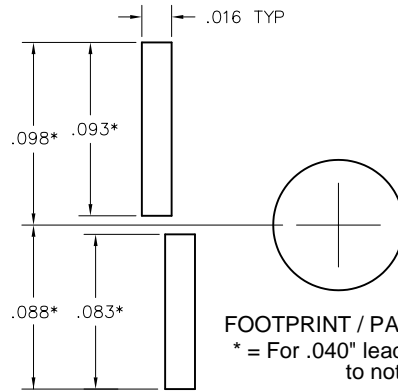

FOOTPRINT / PAD CONFIGURATION
 * = For .040" lead envelope, add .020" to noted dimensions

9 POSITION

9 ○○○○ 6
 5 ○○○○ 1

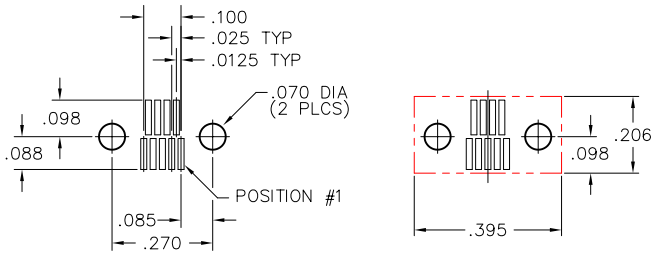

15 POSITION

15 ○○○○○○ 9
 8 ○○○○○○ 1

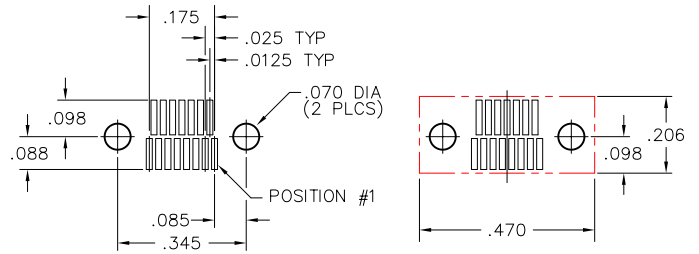

21 POSITION

21 ○○○○○○○○ 12
 11 ○○○○○○○○ 1

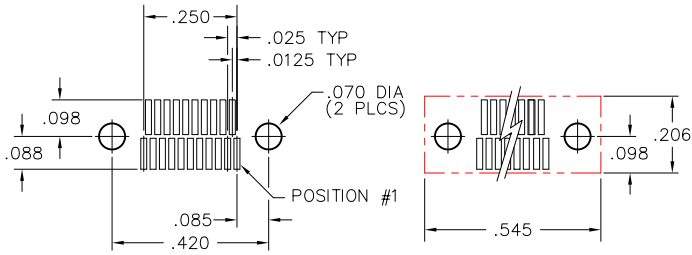

25 POSITION

25 ○○○○○○○○○○ 14
 13 ○○○○○○○○○○ 1

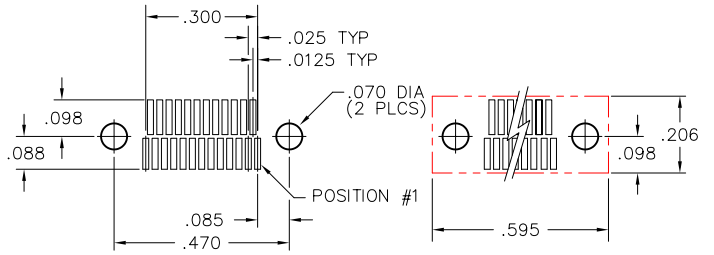

31 POSITION

31 ○○○○○○○○○○○○ 17
 16 ○○○○○○○○○○○○ 1

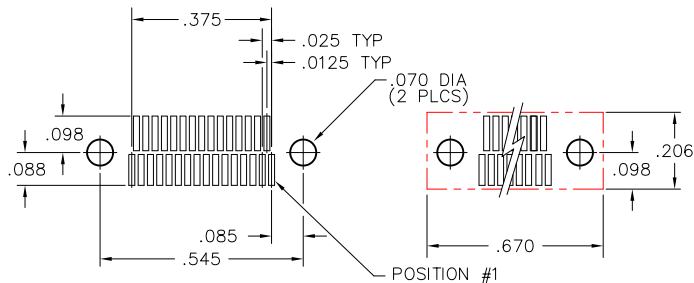

37 POSITION

37 ○○○○○○○○○○○○○○ 20
 19 ○○○○○○○○○○○○○○ 1

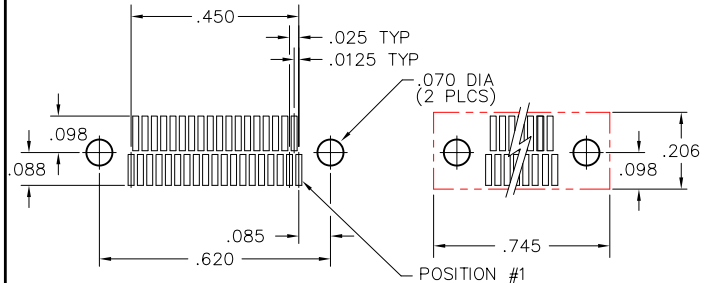

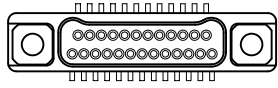
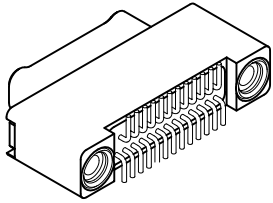

CONNECTOR MATING FACE

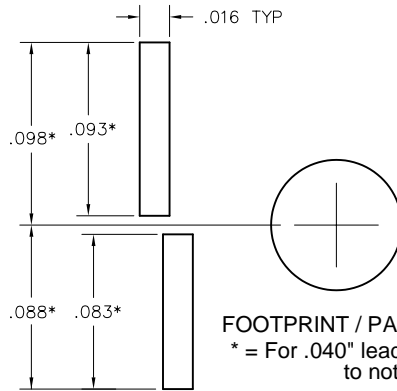

FOOTPRINT / PAD CONFIGURATION
 * = For .040" lead envelope, add .020" to noted dimensions



Recommended PC Board Layout

Vertical SMT Plug
 .020 & .040 Lead Envelopes
 FOR REFERENCE ONLY

No solder mask allowed within connector outline

51 POSITION

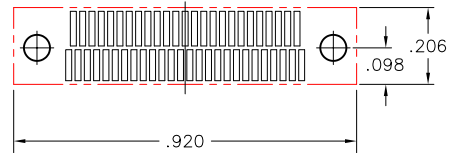
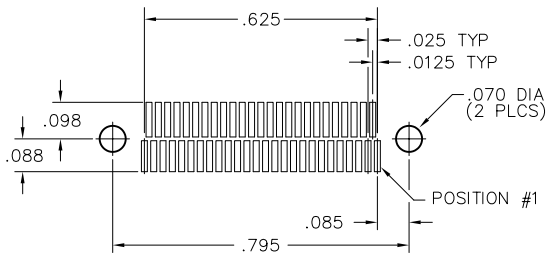
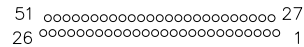

65 POSITION

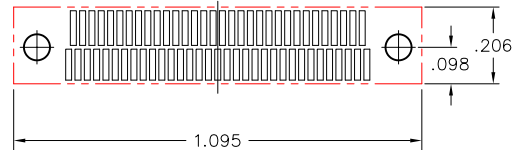
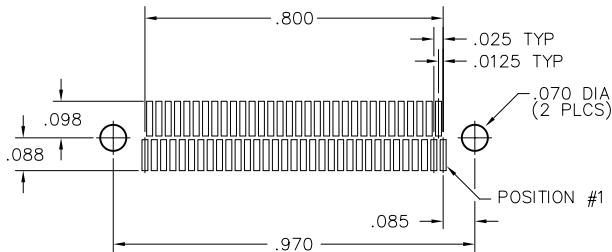
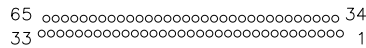

69 POSITION

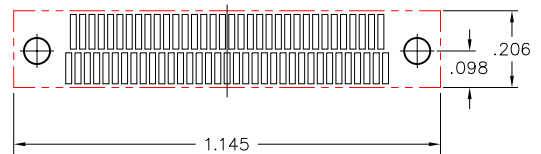
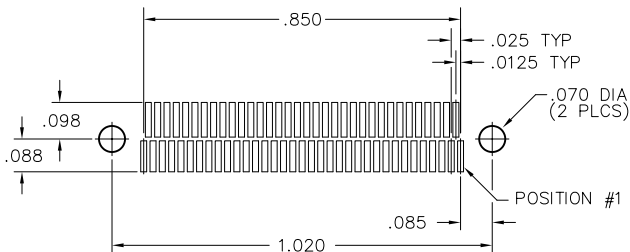
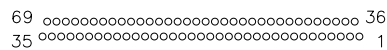



Recommended PC Board Layout

Vertical SMT Plug
.020 & .040 Lead Envelopes
FOR REFERENCE ONLY

No solder mask allowed
within connector outline

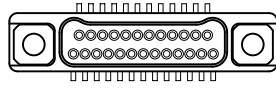
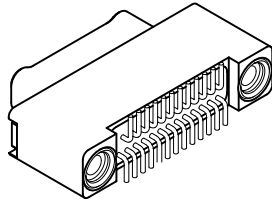

CONNECTOR MATING FACE

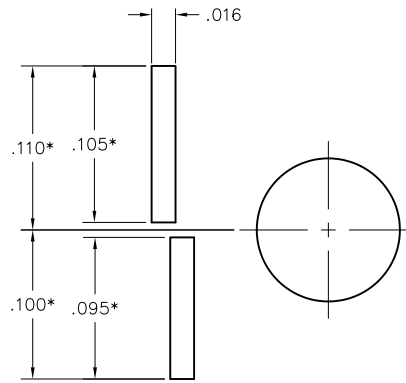

FOOTPRINT / PAD CONFIGURATION
* = For .040" lead envelope, add .020" to noted dimensions

85 POSITION

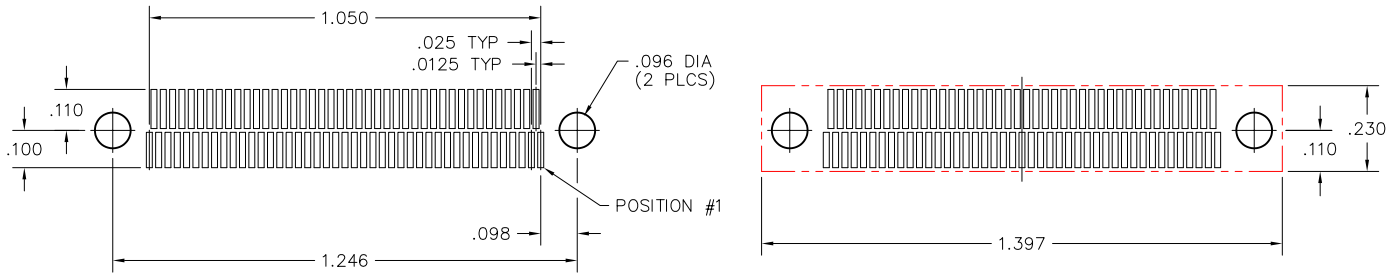
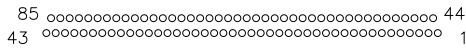

91 POSITION

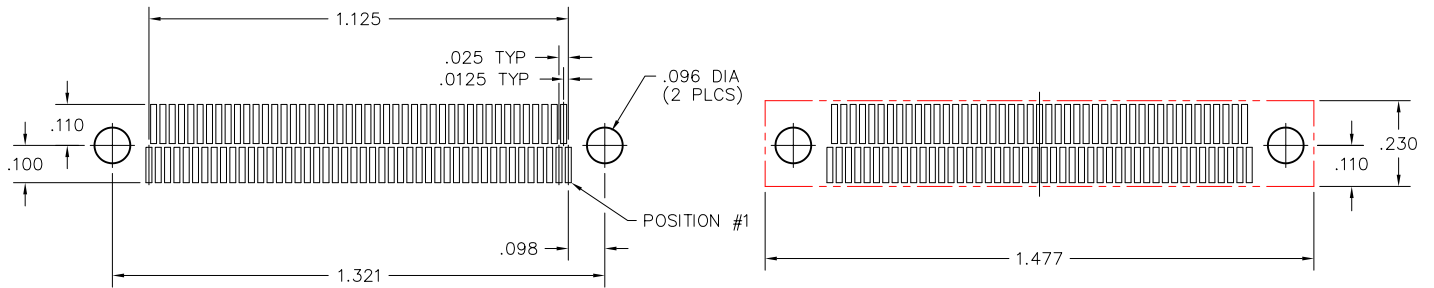
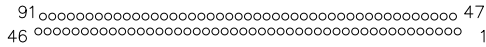



Recommended PC Board Layout

Vertical SMT Receptacle
 .020 & .040 Lead Envelopes
 FOR REFERENCE ONLY

CONNECTOR MATING FACE

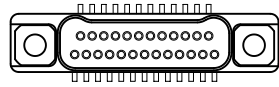
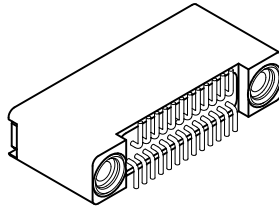

No solder mask allowed within connector outline

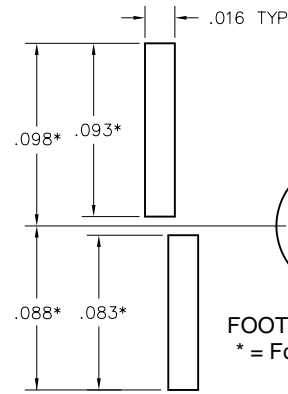

FOOTPRINT / PAD CONFIGURATION
 * = For .040" lead envelope, add .020" to noted dimensions

9 POSITION

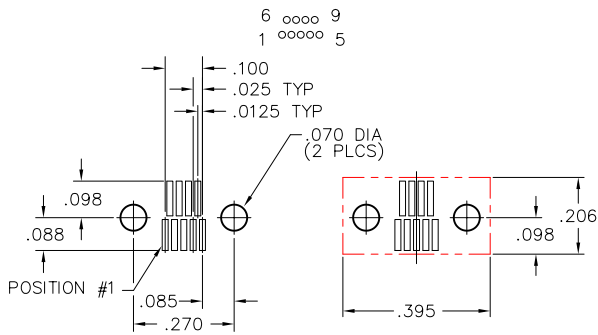

15 POSITION

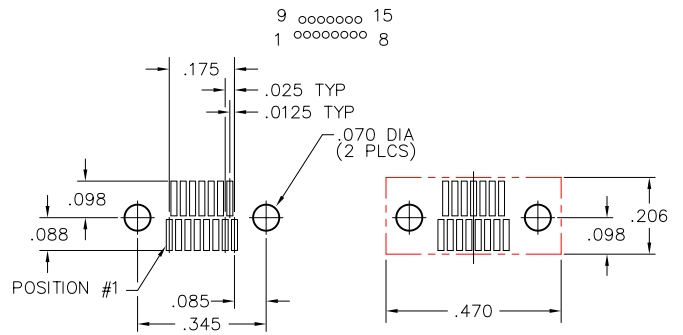

21 POSITION

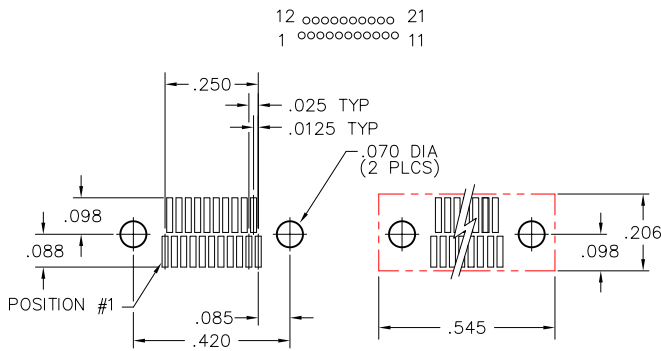

25 POSITION

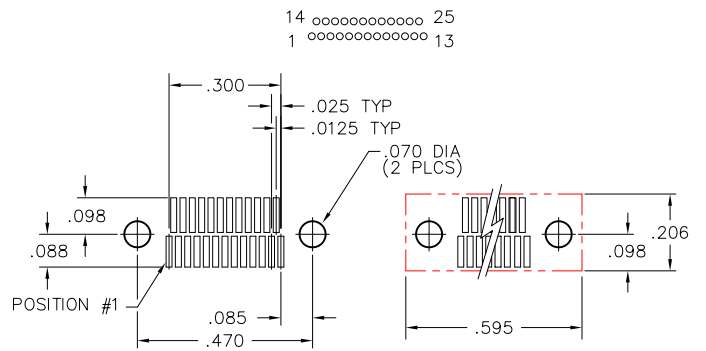

31 POSITION

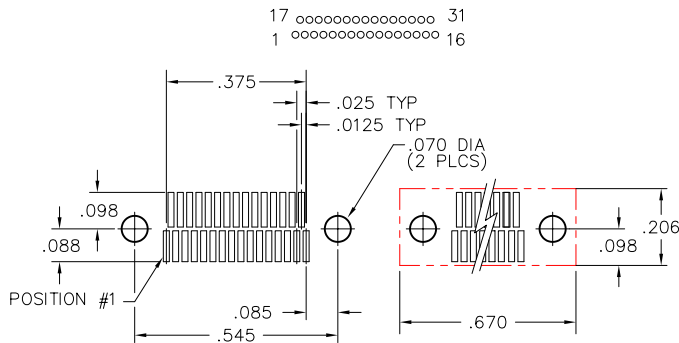

37 POSITION

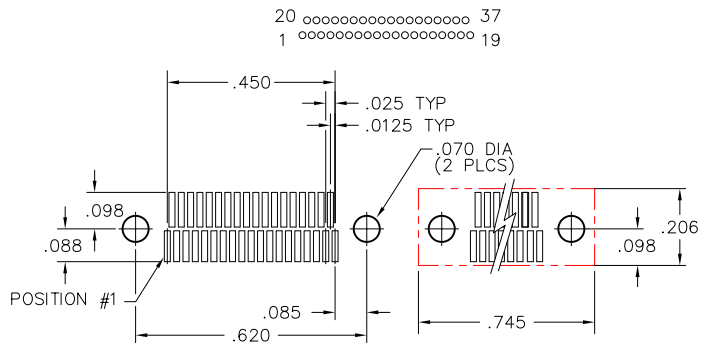



Recommended PC Board Layout

Vertical SMT Receptacle
.020 & .040 Lead Envelopes
FOR REFERENCE ONLY

No solder mask allowed within connector outline

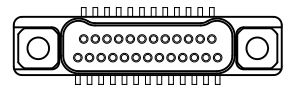
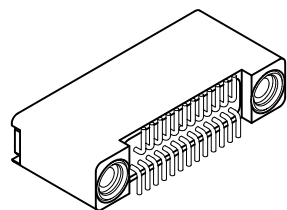

CONNECTOR MATING FACE

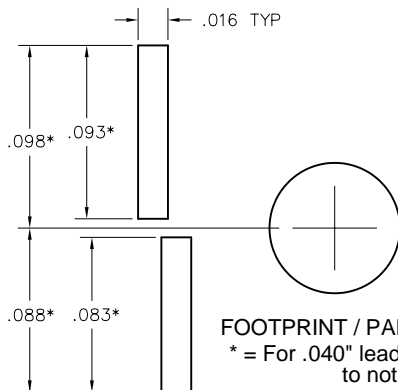

FOOTPRINT / PAD CONFIGURATION
* = For .040" lead envelope, add .020" to noted dimensions

51 POSITION

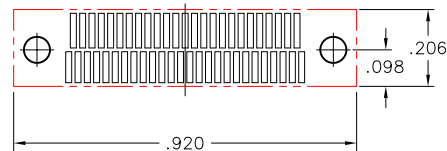
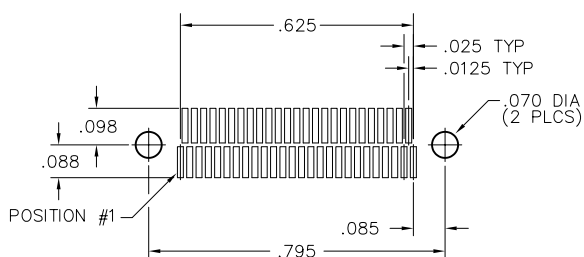
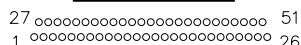

65 POSITION

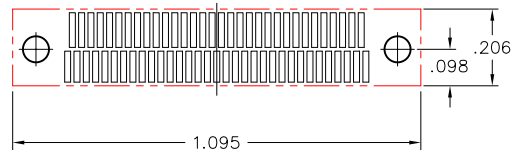
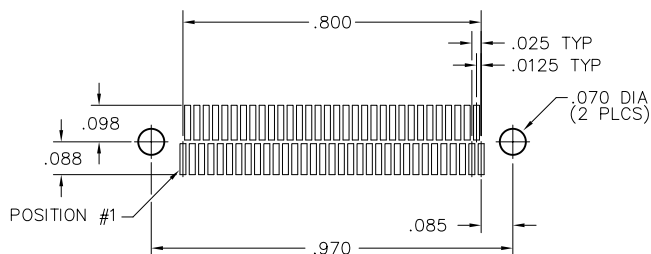
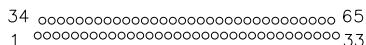

69 POSITION

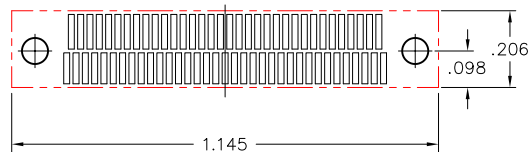
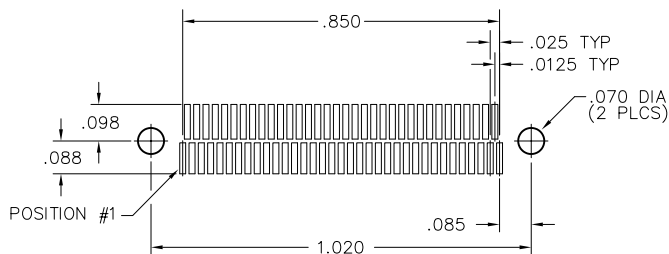
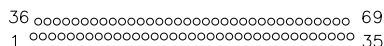



Recommended PC Board Layout

Vertical SMT Receptacle
 .020 & .040 Lead Envelopes
 FOR REFERENCE ONLY

CONNECTOR MATING FACE

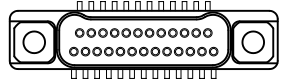
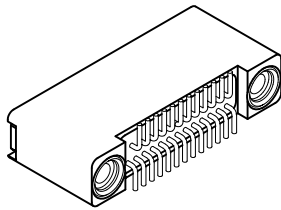

CONNECTOR MATING FACE

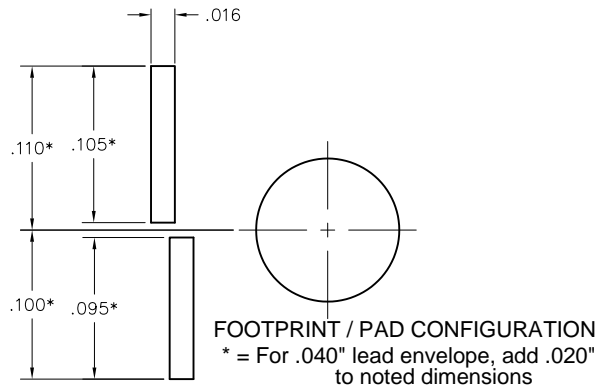

85 POSITION

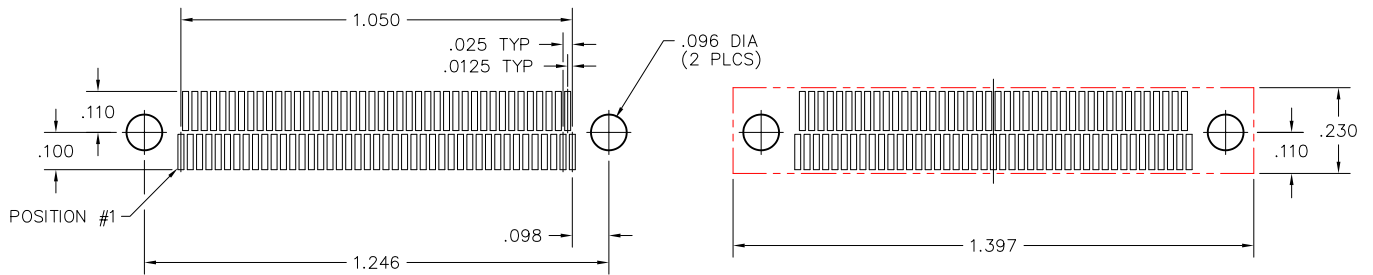
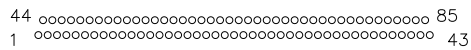

91 POSITION

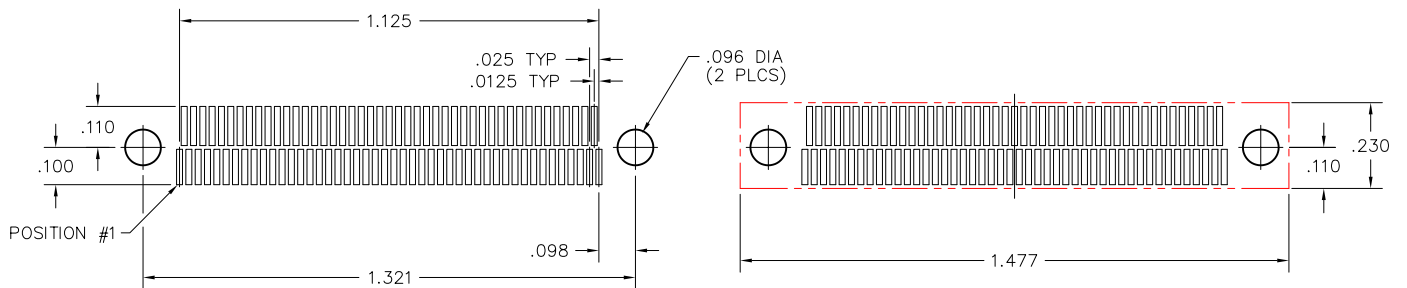
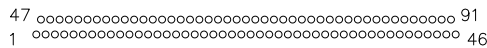



NM-212-025-161-THAC
(METAL)

2 · ROW Cable to Vertical SMT w/ Mounting Ears

.025"

NM, NK

9 thru 85 Contacts

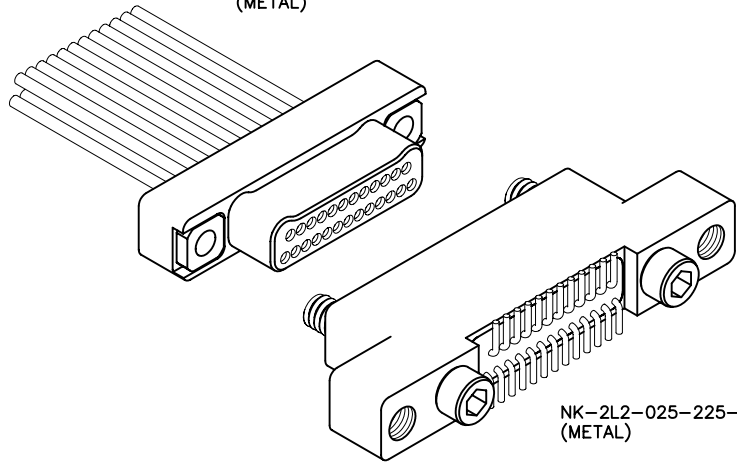

NK-2L2-025-225-JC00
(METAL)

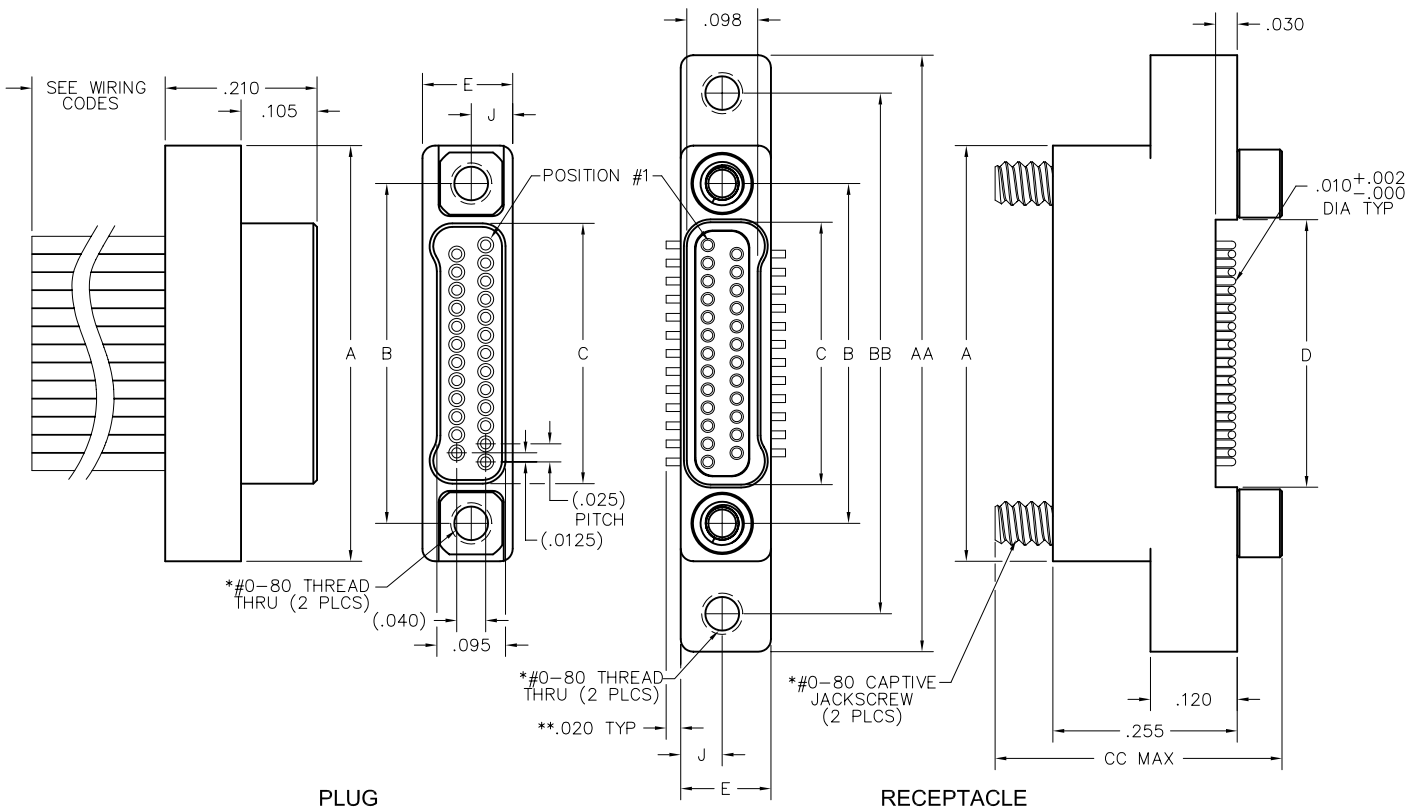

SIZE	A	B	C		D	E	J	AA	BB	CC	HARDWARE*
			PLUG	RCPT							
9	.375	.270	.160	.163	.170			.625	.520		
15	.450	.345	.235	.238	.245			.700	.595		
21	.525	.420	.310	.313	.320			.775	.670		
25	.575	.470	.360	.363	.370			.825	.720		
31	.650	.545	.435	.438	.445	.125	.0575	.900	.795	.415	#0-80 THREAD
37	.725	.620	.510	.513	.520			.975	.870		
51	.900	.795	.685	.688	.695			1.150	1.045		
65	1.075	.970	.860	.863	.870			1.325	1.220		
69	1.125	1.020	.910	.913	.920			1.375	1.270		
85	1.377	1.246	1.110	1.113	1.120	.150	.0700	1.679	1.546	.435	#2-56 THREAD

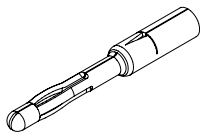

PIN CONTACT
3 TINE SPRING MEMBER,
CRIMP

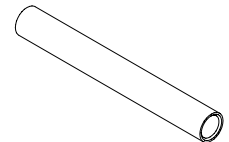

SOCKET CONTACT
DRAWN TUBE, CRIMP

* = #2-56 UNC THREAD ON 85 POSITION CONNECTORS

** = DIMENSION CHANGES TO .040" FOR "010" OPTION.

SEE PAGE N-54.

PLUG: NM-212-025-161-THAC
RECEPTACLE: NK-2L2-025-225-JC00
 XX-XXX-XXX-XXX-XXXX-XXX

PLUG

RECEPTACLE

SERIES

NM .025" Metal I/O Connector | NK .025" Metal PC Board Mounted Connector

BODY

2	2-Row	2	2-Row
1	BODY STYLE: Plug, straight	L	BODY STYLE: Receptacle, vertical SMT w/ mounting ears
2	BODY MATERIAL: Liquid Crystal Polymer w/ electroless nickel shell	2	BODY MATERIAL: Liquid Crystal Polymer w/ electroless nickel shell
3	BODY MATERIAL: Liquid Crystal Polymer w/ electrodeposited cadmium shell <input checked="" type="checkbox"/>	3	BODY MATERIAL: Liquid Crystal Polymer w/ electrodeposited cadmium shell <input checked="" type="checkbox"/>

SIZE

XXX Number of contacts (009, 015, 021, 025, 031, 037, 051, 065, 069 or 085) | XXX Number of contacts (009, 015, 021, 025, 031, 037, 051, 065, 069 or 085)

CONTACTS

16	TYPE CONTACTS/TERMINATIONS: Pin, straight, crimped wire	22	TYPE CONTACTS/TERMINATIONS: Socket, SMT (.020 lead envelope)
1	PLATING OPTIONS: 50 u" Au contacts	5	PLATING OPTIONS: 50 u" Au contacts; Sn/Pb alloy terminations <input checked="" type="checkbox"/>
		8	PLATING OPTIONS: 50 u" Au contacts; Tin plated terminations

HARDWARE

00	STYLE OF HARDWARE: None	00	STYLE OF HARDWARE: None
TH	STYLE OF HARDWARE: Threaded hole, #0-80 UNF*	JC	STYLE OF HARDWARE: Turning jackscrews, captivated #0-80 UNF*
XX	WIRING OPTIONS: See wiring codes, Page NA-2	00	WIRING OPTIONS: None

OPTIONS

010 .040 lead envelope

* = #2-56 UNC thread on 85 position connectors
 .050 hex key (#0-80 thread)
 1/16" hex key (#2-56 thread)
 Recommended torque value 1.0 inch-lbs. max. (#0-80 thread)
 Recommended torque value 2.0 inch-lbs. max. (#2-56 thread)
 Ball end hex wrench not recommended
 Hex wrench key/bit conforming to the requirements of ASME / ANSI-B-18.3 is recommended.
 .050" hex L-key long arm wrench - order AirBorn p/n CDG14148.
 1/16" hex L-key long arm wrench - order AirBorn p/n CDG14160.

= Option not RoHS compliant

2 · ROW Cable to Vertical SMT w/ Mounting Ears

.025"

NM, NK

9 thru 85 Contacts

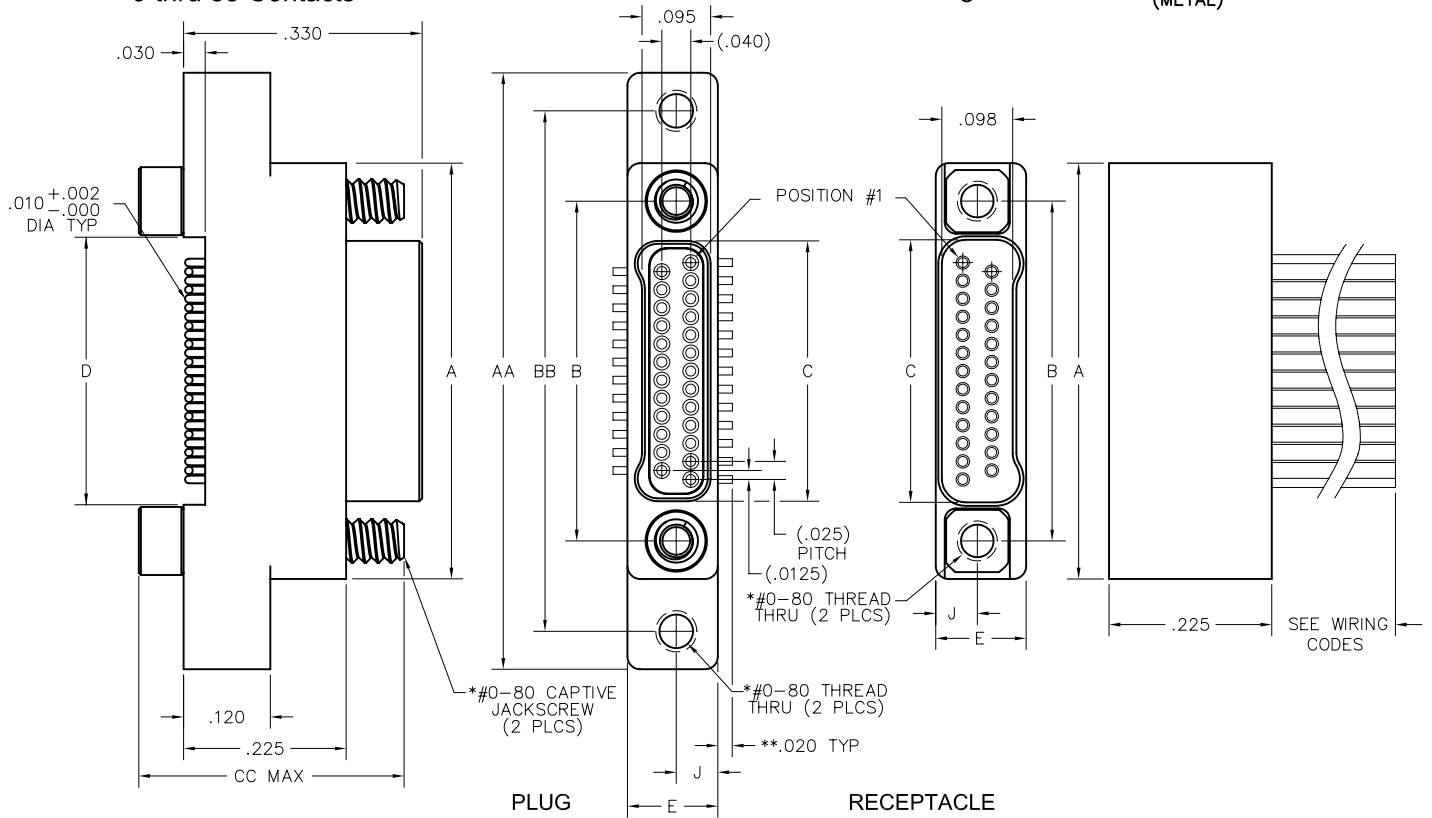

NM-222-025-261-THAC
(METAL)

NK-2K2-025-125-JC00
(METAL)

PLUG RECEPTACLE

SIZE	A	B	C		D	E	J	AA	BB	CC	HARDWARE*
			PLUG	RCPT							
9	.375	.270	.160	.163	.170			.625	.520		
15	.450	.345	.235	.238	.245			.700	.595		
21	.525	.420	.310	.313	.320			.775	.670		
25	.575	.470	.360	.363	.370			.825	.720		
31	.650	.545	.435	.438	.445	.125	.0575	.900	.795	.385	#0-80 THREAD
37	.725	.620	.510	.513	.520			.975	.870		
51	.900	.795	.685	.688	.695			1.150	1.045		
65	1.075	.970	.860	.863	.870			1.325	1.220		
69	1.125	1.020	.910	.913	.920			1.375	1.270		
85	1.377	1.246	1.110	1.113	1.120	.150	.0700	1.679	1.546	.405	#2-56 THREAD

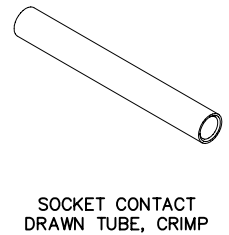
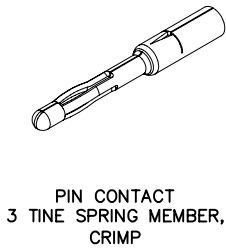

* = #2-56 UNC THREAD ON 85 POSITION CONNECTORS
 ** = DIMENSION CHANGES TO .040" FOR "010" OPTION.
 SEE PAGE N-56.

PLUG: NK-2K2-025-125-JC00
RECEPTACLE: NM-222-025-261-THAC
 XX-XXX-XXX-XXX-XXXX-XXX

PLUG	RECEPTACLE
SERIES	

NK .025" Metal PC Board Mounted Connector	NM .025" Metal I/O Connector
---	------------------------------

BODY	
-------------	--

2 2-Row	2 2-Row
BODY STYLE: K Plug, vertical SMT w/ mounting ears	BODY STYLE: 2 Receptacle, straight
BODY MATERIAL: 2 Liquid Crystal Polymer w/ electroless nickel shell	BODY MATERIAL: 2 Liquid Crystal Polymer w/ electroless nickel shell
3 Liquid Crystal Polymer w/ electrodeposited cadmium shell <input checked="" type="checkbox"/>	3 Liquid Crystal Polymer w/ electrodeposited cadmium shell <input checked="" type="checkbox"/>

SIZE	
-------------	--

XXX Number of contacts (009, 015, 021, 025, 031, 037, 051, 065, 069 or 085)	XXX Number of contacts (009, 015, 021, 025, 031, 037, 051, 065, 069 or 085)
---	---

CONTACTS	
-----------------	--

TYPE CONTACTS/TERMINATIONS: 12 Pin, SMT (.020 lead envelope)	TYPE CONTACTS/TERMINATIONS: 26 Socket, straight, crimped wire
PLATING OPTIONS: 5 50 u" Au contacts; Sn/Pb alloy terminations <input checked="" type="checkbox"/> 8 50 u" Au contacts; Tin plated terminations	PLATING OPTIONS: 1 50 u" Au contacts

HARDWARE	
-----------------	--

STYLE OF HARDWARE: 00 None JC Turning jackscrews, captivated #0-80 UNF*	STYLE OF HARDWARE: 00 None TH Threaded hole, #0-80 UNF*
WIRING OPTIONS: 00 None	WIRING OPTIONS: XX See wiring codes, Page NA-2

OPTIONS	
----------------	--

010 .040 lead envelope	
------------------------	--

* = #2-56 UNC thread on 85 position connectors
 .050 hex key (#0-80 thread)
 1/16" hex key (#2-56 thread)
 Recommended torque value 1.0 inch-lbs. max. (#0-80 thread)
 Recommended torque value 2.0 inch-lbs. max. (#2-56 thread)
 Ball end hex wrench not recommended
 Hex wrench key/bit conforming to the requirements of ASME / ANSI-B-18.3 is recommended.
 .050" hex L-key long arm wrench - order AirBorn p/n CDG14148.
 1/16" hex L-key long arm wrench - order AirBorn p/n CDG14160.

= Option not RoHS compliant



Recommended PC Board Layout

Vertical SMT Plug w/ Mounting Ears
 .020 & .040 Lead Envelopes
 FOR REFERENCE ONLY

No solder mask allowed
 within connector outline

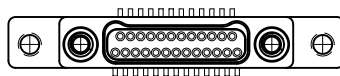
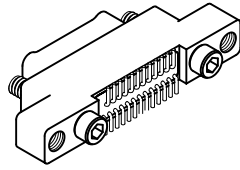

CONNECTOR MATING FACE

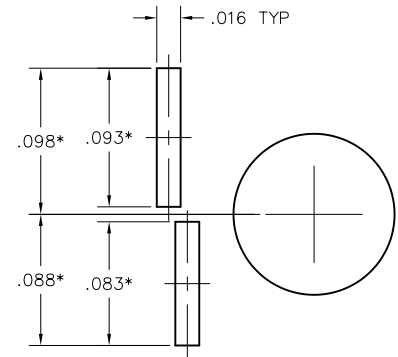

FOOTPRINT / PAD CONFIGURATION
 * = For .040" lead envelope, add .020" to noted dimensions

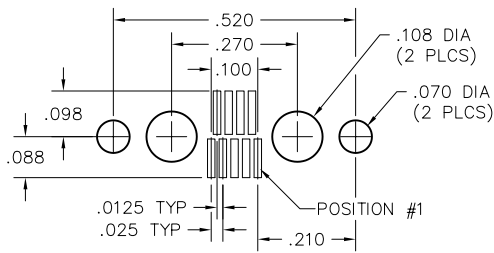

9 POSITION

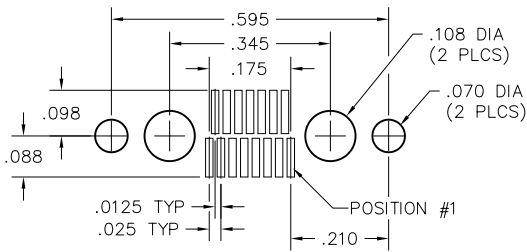
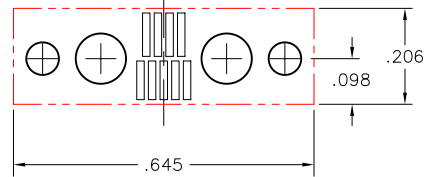

15 POSITION

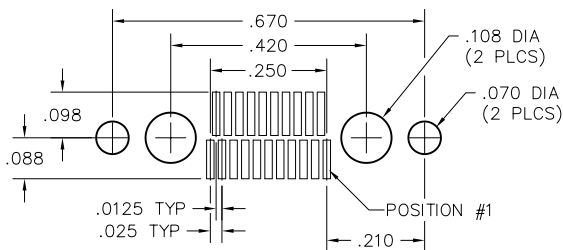
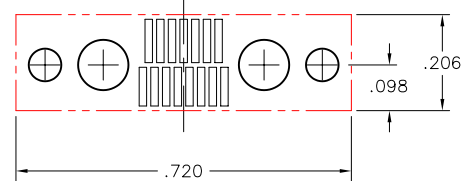

21 POSITION

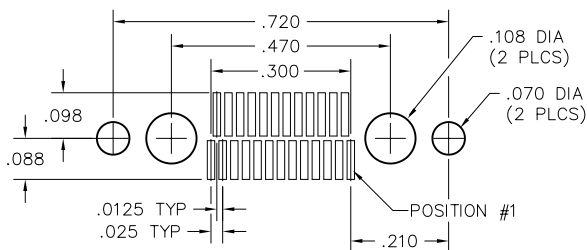
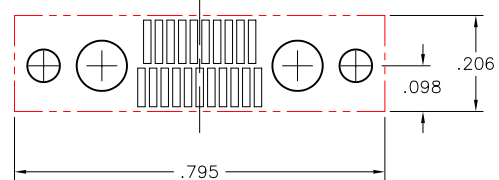
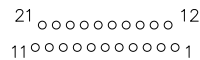

25 POSITION

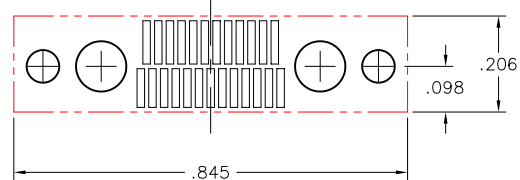
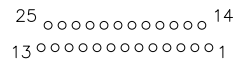

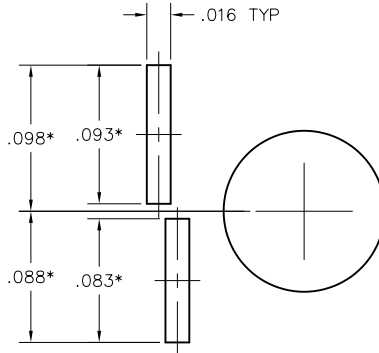
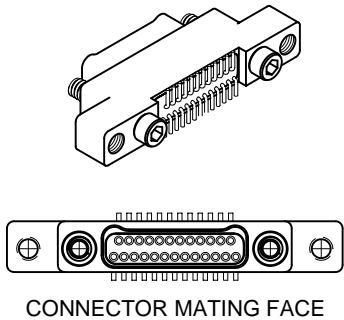

Recommended PC Board Layout

Vertical SMT Plug w/ Mounting Ears
 .020 & .040 Lead Envelopes
 FOR REFERENCE ONLY

No solder mask allowed within connector outline

FOOTPRINT / PAD CONFIGURATION
 * = For .040" lead envelope, add .020" to noted dimensions

31 POSITION

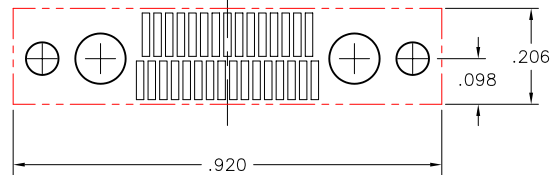
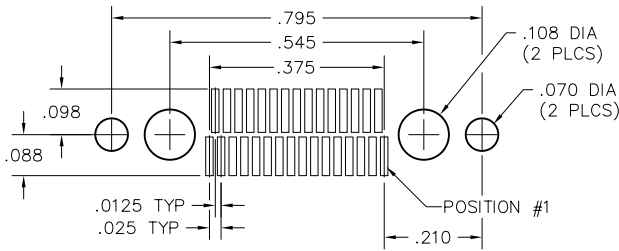
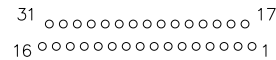

37 POSITION

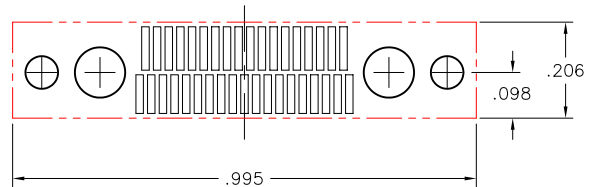
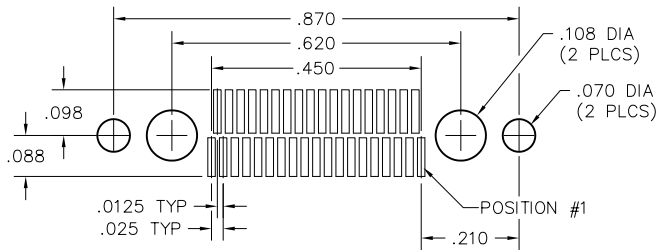
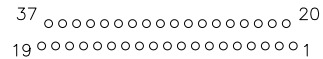

51 POSITION

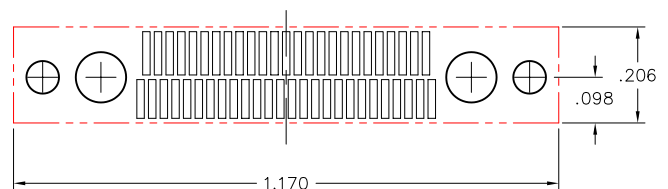
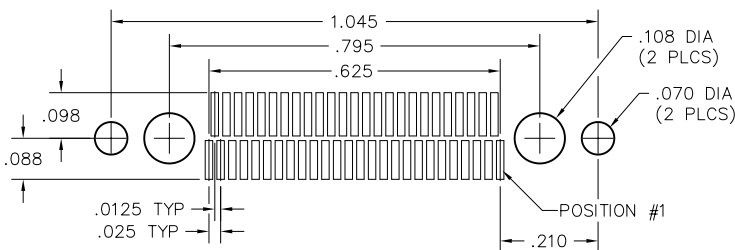
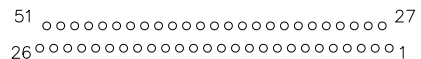

65 POSITION

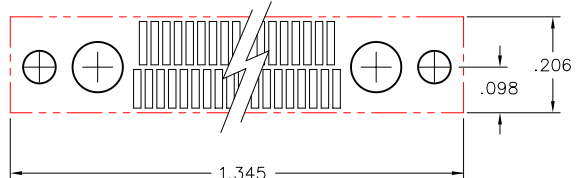
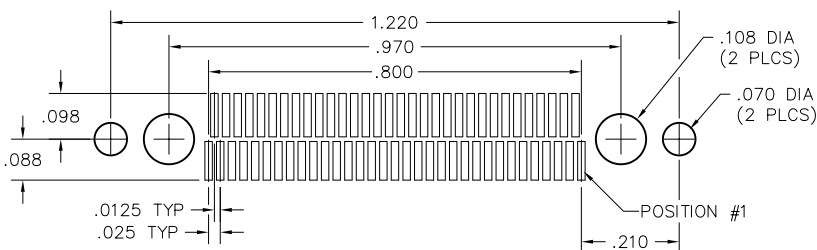
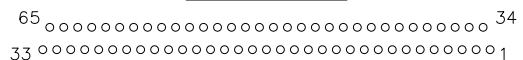

Ask About AirBorn's Accelerated Delivery Service



Recommended PC Board Layout

Vertical SMT Plug w/ Mounting Ears
 .020 & .040 Lead Envelopes
 FOR REFERENCE ONLY

No solder mask allowed within connector outline

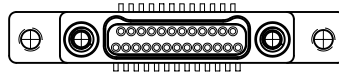
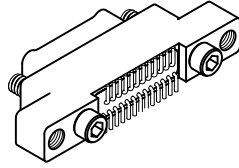

CONNECTOR MATING FACE

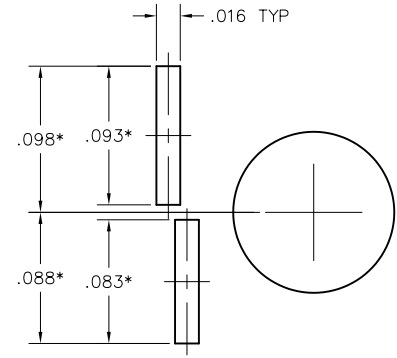

FOOTPRINT / PAD CONFIGURATION
 * = For .040" lead envelope, add .020" to noted dimensions

69 POSITION

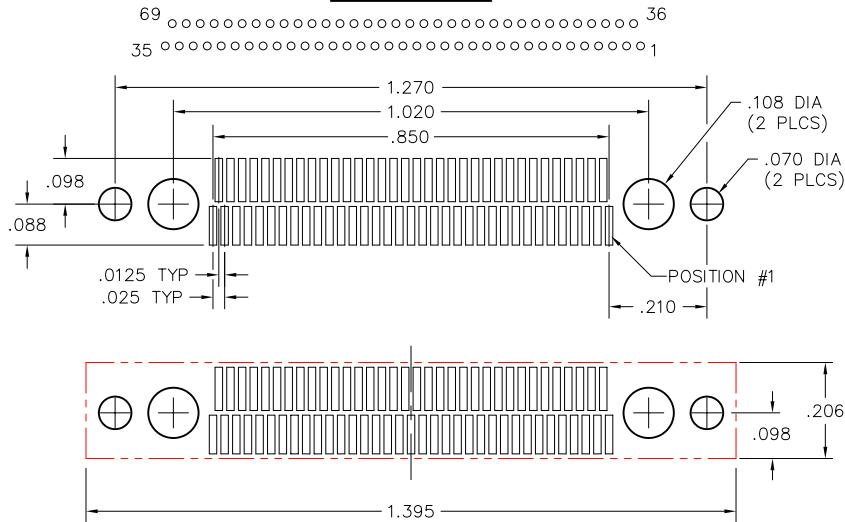

85 POSITION

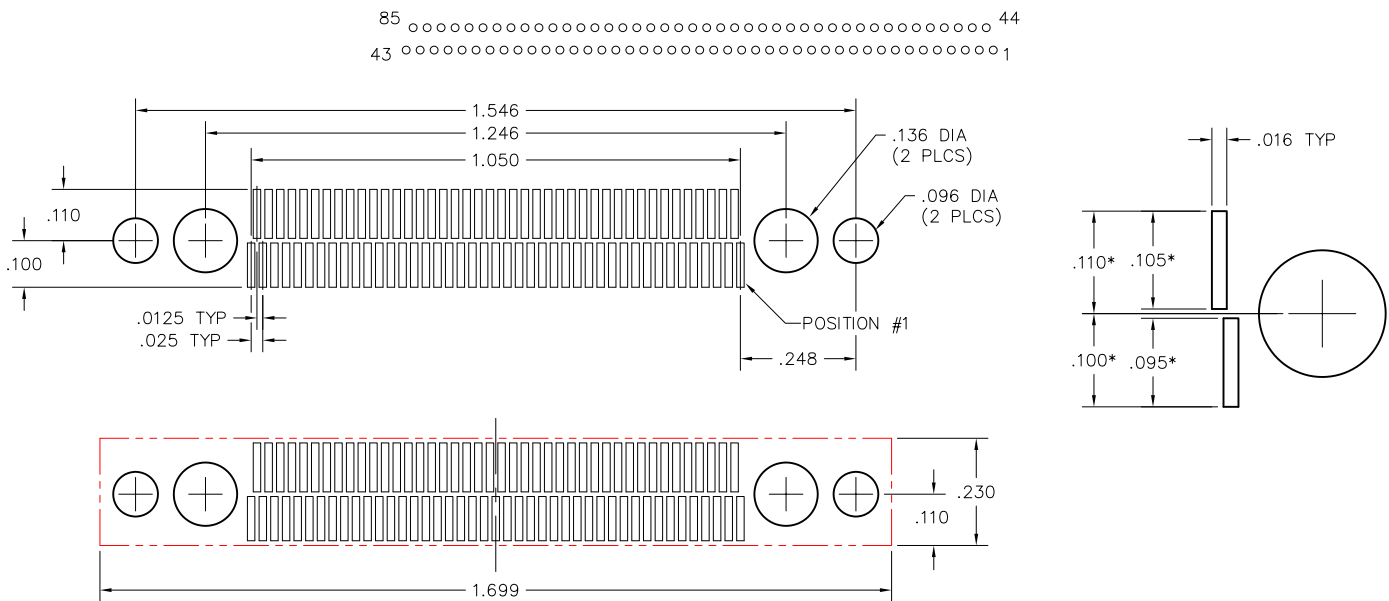



Recommended PC Board Layout

Vertical SMT Rcpt w/ Mounting Ears
 .020 & .040 Lead Envelopes
 FOR REFERENCE ONLY

No solder mask allowed
 within connector outline

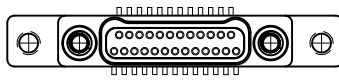
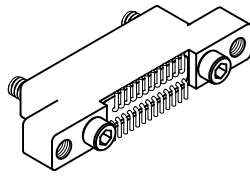

CONNECTOR MATING FACE

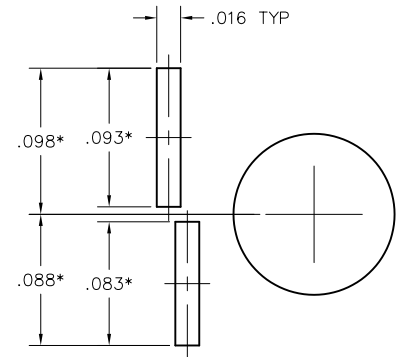

FOOTPRINT / PAD CONFIGURATION
 * = For .040" lead envelope, add .020" to noted dimensions

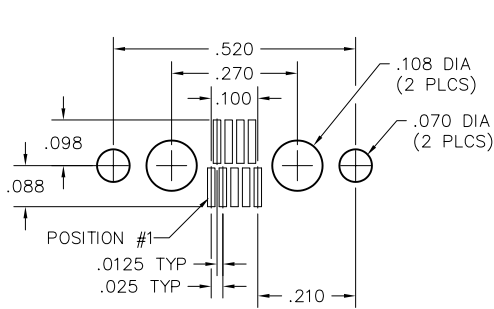

9 POSITION

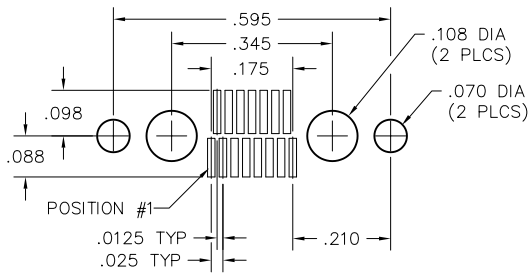
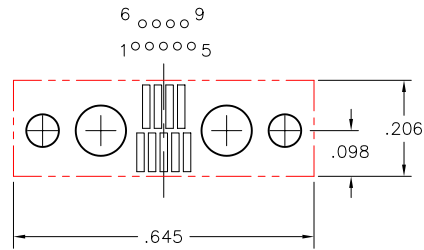

15 POSITION

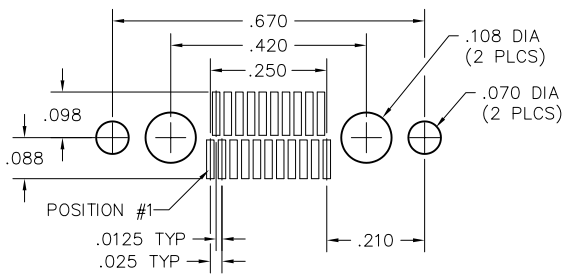
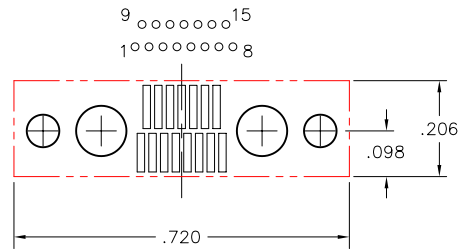

21 POSITION

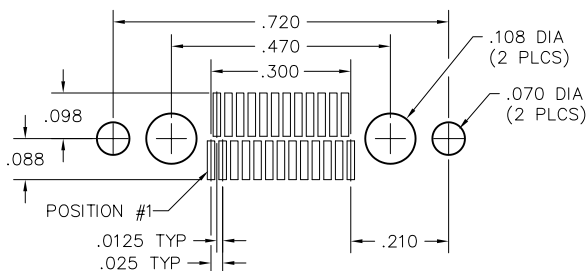
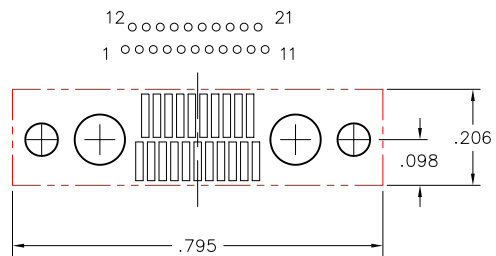

25 POSITION

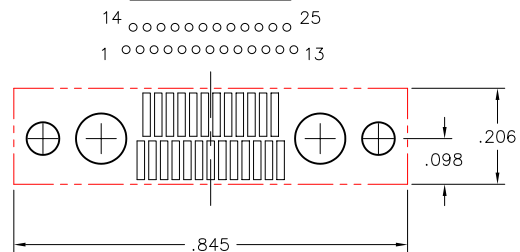

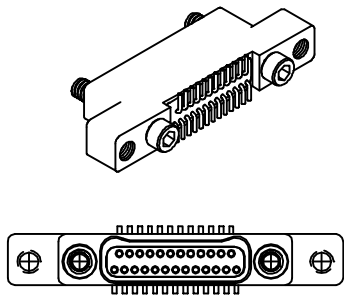

CONNECTOR MATING FACE

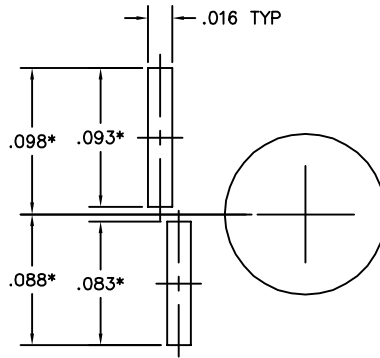

FOOTPRINT / PAD CONFIGURATION

* = For .040" lead envelope, add .020" to noted dimensions



Recommended PC Board Layout

Vertical SMT Rcpt w/ Mounting Ears
 .020 & .040 Lead Envelopes
 FOR REFERENCE ONLY

No solder mask allowed within connector outline

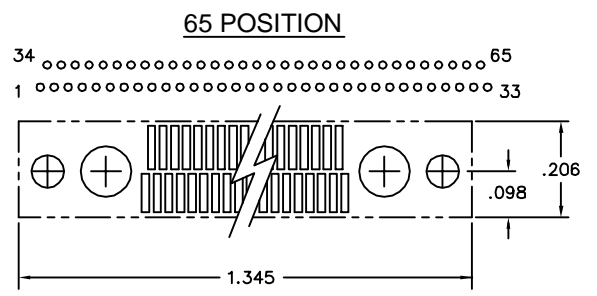
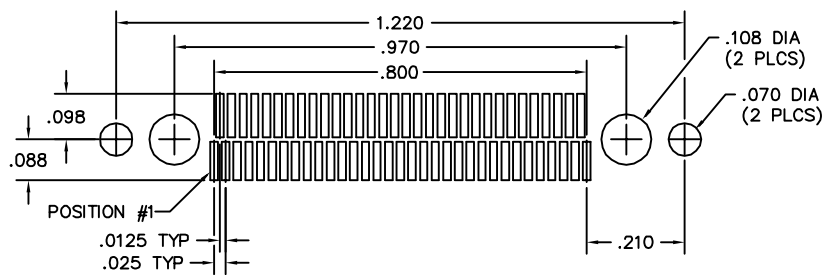
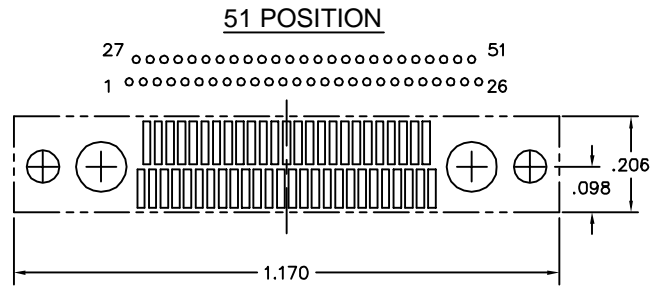
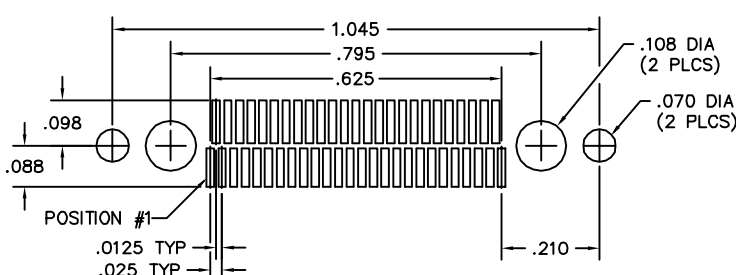
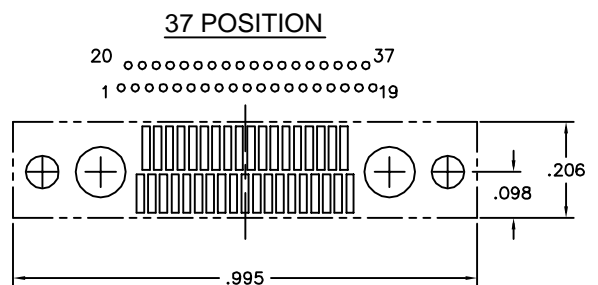
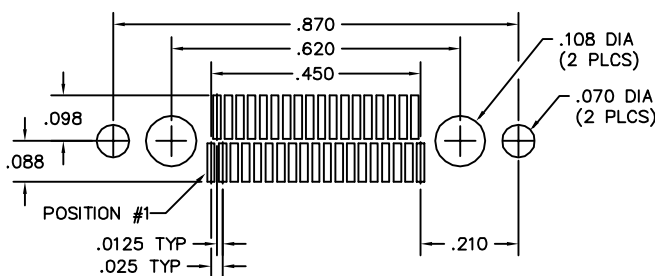
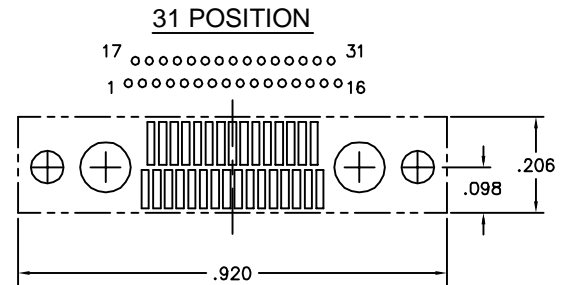
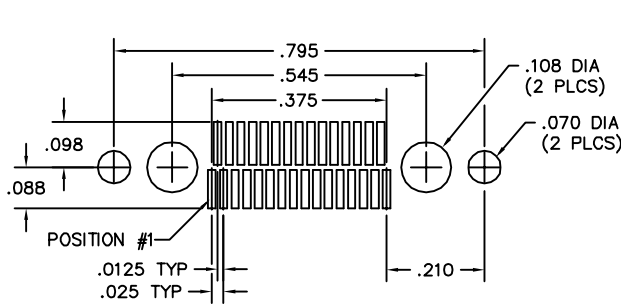

Ask About AirBorn's Accelerated Delivery Service



Recommended PC Board Layout

Vertical SMT Plug w/ Mounting Ears
.020 & .040 Lead Envelopes
FOR REFERENCE ONLY

No solder mask allowed within connector outline

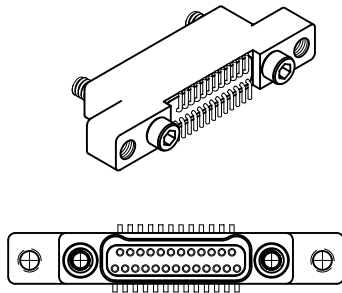

CONNECTOR MATING FACE

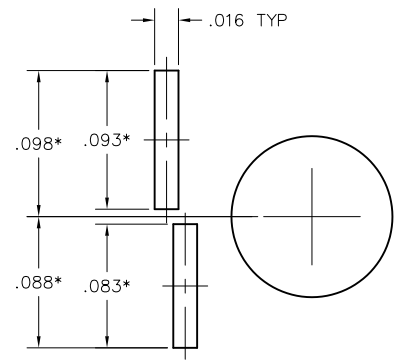

FOOTPRINT / PAD CONFIGURATION
* = For .040" lead envelope, add .020" to noted dimensions

69 POSITION

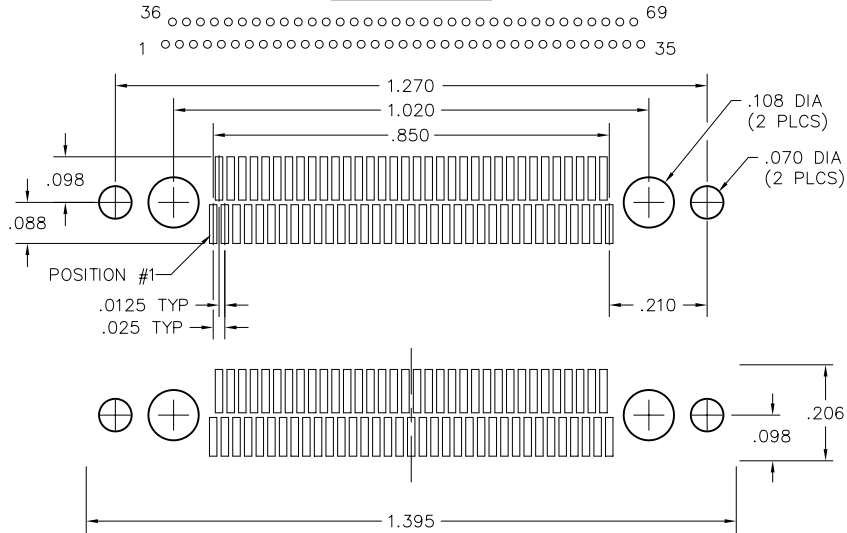

85 POSITION

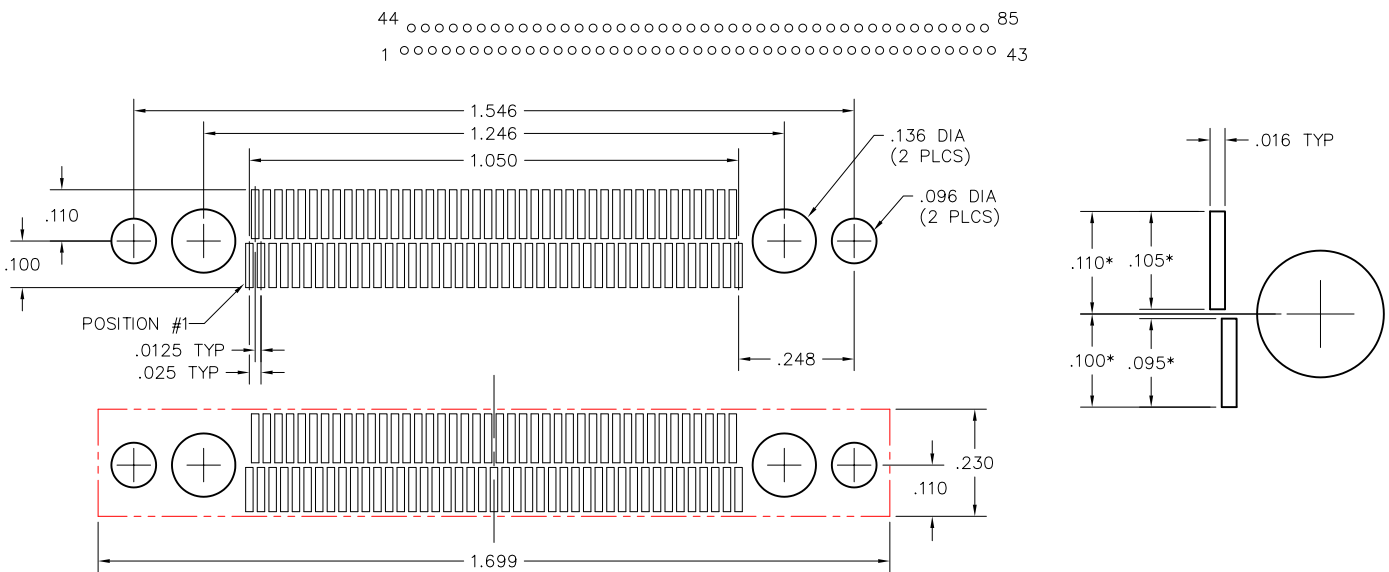



2 · ROW Cable to Board Right Angle PTH

.025"

NM, NK

9 thru 91 Contacts

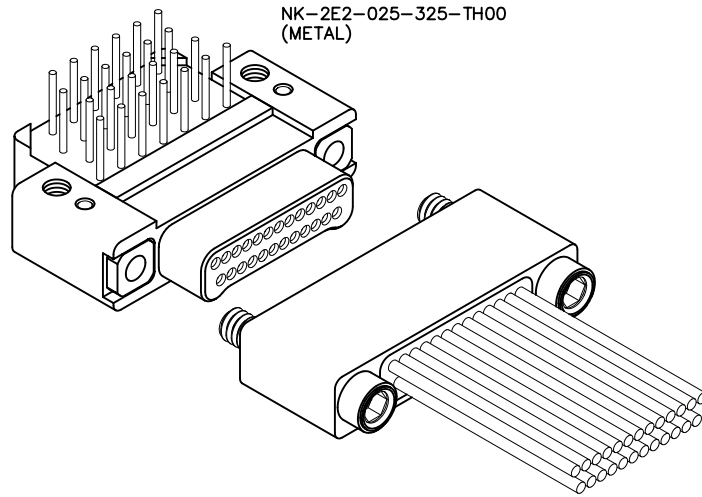

NM-222-025-261-JCAC
(METAL)

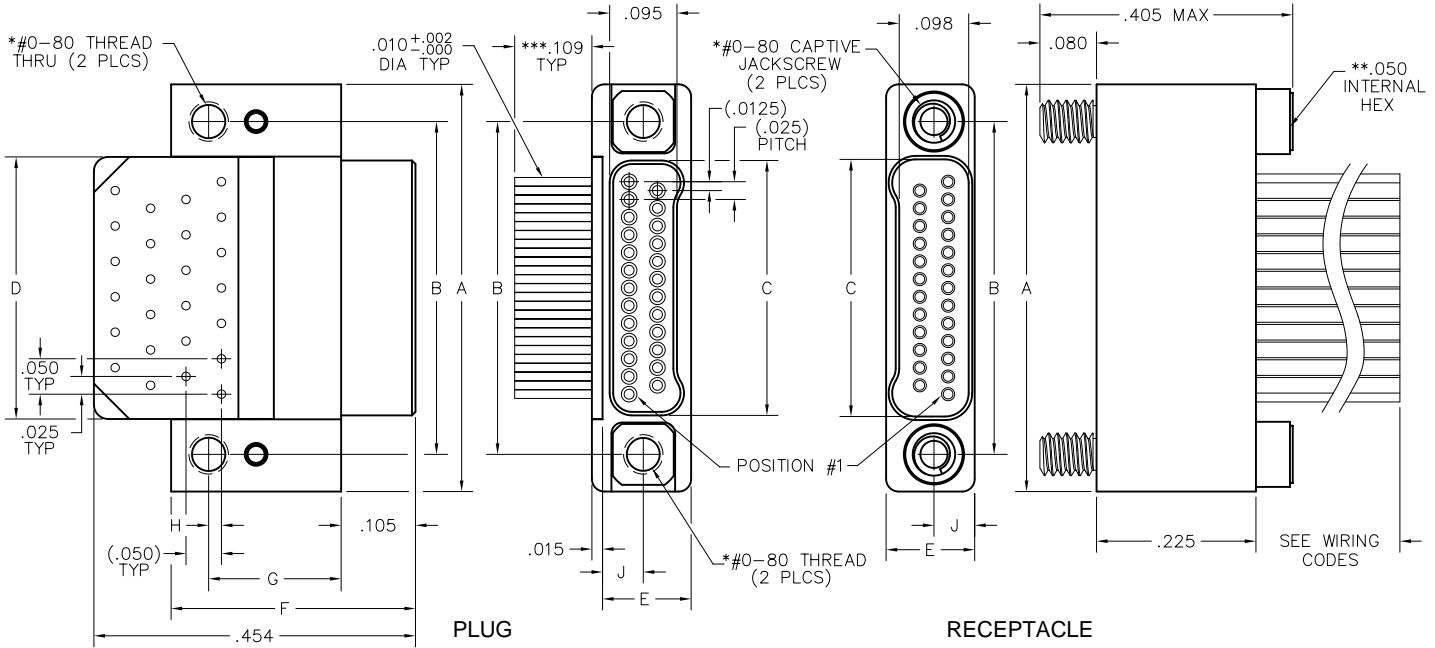

SIZE	A	B	C		D	E	F	G	H	J	*HARDWARE
			PLUG	RCPT							
9	.375	.270	.160	.163	.170	.125	.345	.187	.018	.0575	#0-80 THREAD
15	.450	.345	.235	.238	.245						
21	.525	.420	.310	.313	.320						
25	.575	.470	.360	.363	.370						
31	.650	.545	.435	.438	.445						
37	.725	.620	.510	.513	.520						
51	.900	.795	.685	.688	.695						
65	1.075	.970	.860	.863	.870						
69	1.125	1.020	.910	.913	.920	.150	.410	.244	.075	.0700	#2-56 THREAD
85	1.377	1.246	1.110	1.113	1.120						
91	1.452	1.321	1.185	1.188	1.195						

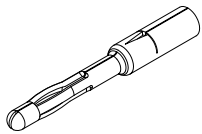

PIN CONTACT
3 TINE SPRING MEMBER, CRIMP

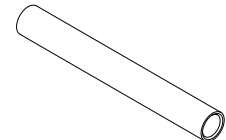

SOCKET CONTACT
DRAWN TUBE, CRIMP

- * = #2-56 UNC THREAD ON 85 AND 91 POSITION CONNECTORS.
- ** = 1/16" HEX ON 85 AND 91 POSITION CONNECTORS. HEX MEASUREMENT TAKEN ACROSS THE FLATS.
- *** = OTHER LENGTHS AS REQUIRED

PLUG: NK-2E2-025-325-TH00
RECEPTACLE: NM-222-025-261-JCAC
 XX-XXX-XXX-XXX-XXXX

PLUG	RECEPTACLE
SERIES	

NK .025" Metal PC Board Mounted Connector	NM .025" Metal I/O Connector
---	------------------------------

BODY	
-------------	--

2 2-Row	2 2-Row
---------	---------

BODY STYLE: E Plug, right angle, plated thru hole (PTH)	BODY STYLE: 2 Receptacle, straight 6 Receptacle, straight, with factory installed backshell (See page NA-3)
---	--

BODY MATERIAL: 2 Liquid Crystal Polymer w/ electroless nickel shell 3 Liquid Crystal Polymer w/ electrodeposited cadmium shell <input checked="" type="checkbox"/>	BODY MATERIAL: 2 Liquid Crystal Polymer w/ electroless nickel shell 3 Liquid Crystal Polymer w/ electrodeposited cadmium shell <input checked="" type="checkbox"/>
---	---

SIZE	
-------------	--

XXX Number of contacts (009, 015, 021, 025, 031, 037, 051, 065, 069, 085 or 091)	XXX Number of contacts (009, 015, 021, 025, 031, 037, 051, 065, 069, 085, or 091)
--	---

CONTACTS	
-----------------	--

TYPE CONTACTS/TERMINATIONS: 32 Pin, right angle, .109" 33 Pin, right angle, .140" 34 Pin, right angle, .172"	TYPE CONTACTS/TERMINATIONS: 26 Socket, straight, crimped wire
--	---

PLATING OPTIONS: 5 50 u" Au contacts; Sn/Pb alloy terminations <input checked="" type="checkbox"/> 8 50 u" Au contacts; Tin plated terminations	PLATING OPTIONS: 1 50 u" Au contacts
--	--

HARDWARE	
-----------------	--

STYLE OF HARDWARE: 00 None TH Threaded hole, #0-80 UNF*	STYLE OF HARDWARE: 00 None JC Turning jackscrews, captivated #0-80 UNF*
--	--

WIRING OPTIONS: 00 None	WIRING OPTIONS: XX See wiring codes, Page NA-2
-----------------------------------	--

* = #2-56 UNC thread on 85 and 91 position connectors
 .050 hex key (#0-80 thread)
 1/16" hex key (#2-56 thread)
 Recommended torque value 1.0 inch-lbs. max. (#0-80 thread)
 Recommended torque value 2.0 inch-lbs. max. (#2-56 thread)
 Ball end hex wrench not recommended
 Hex wrench key/bit conforming to the requirements of ASME / ANSI-B-18.3 is recommended.
 .050" hex L-key long arm wrench - order AirBorn p/n CDG14148.
 1/16" hex L-key long arm wrench - order AirBorn p/n CDG14160.

= Option not RoHS compliant

2 · ROW Cable to Board Right Angle PTH

.025"

NM, NK

9 thru 91 Contacts

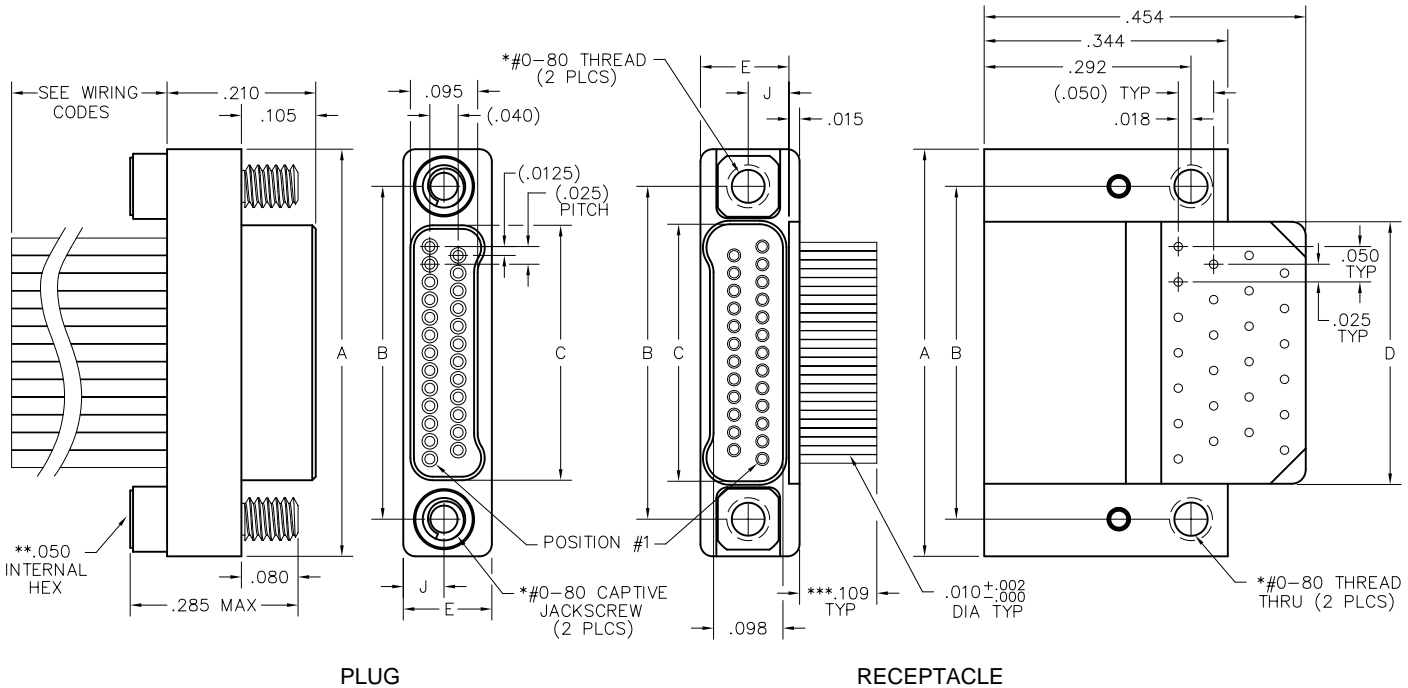
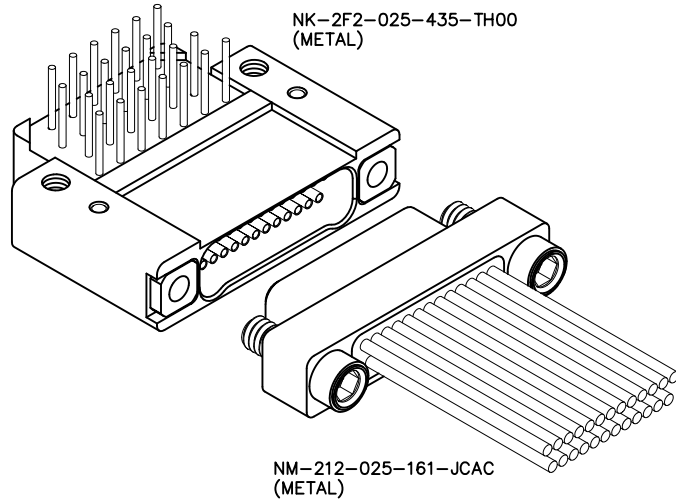

SIZE	A	B	C		D	E	J	*HARDWARE
			PLUG	RCPT				
9	.375	.270	.160	.163	.170			
15	.450	.345	.235	.238	.245			
21	.525	.420	.310	.313	.320			
25	.575	.470	.360	.363	.370			
31	.650	.545	.435	.438	.445	.125	.0575	#0-80 THREAD
37	.725	.620	.510	.513	.520			
51	.900	.795	.685	.688	.695			
65	1.075	.970	.860	.863	.870			
69	1.125	1.020	.910	.913	.920			
85	1.377	1.246	1.110	1.113	1.120	.150	.0700	#2-56 THREAD
91	1.452	1.321	1.185	1.188	1.195			

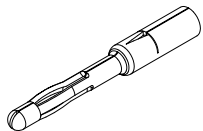

PIN CONTACT
3 TINE SPRING MEMBER, CRIMP

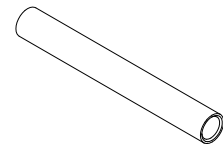

SOCKET CONTACT
DRAWN TUBE, CRIMP

* = #2-56 UNC THREAD ON 85 AND 91 POSITION CONNECTORS.
 ** = 1/16" HEX ON 85 AND 91 POSITION CONNECTORS. HEX MEASUREMENT TAKEN ACROSS THE FLATS.
 *** = OTHER LENGTHS AS REQUIRED

PLUG: NM-212-025-161-JCAC
RECEPTACLE: NK-2F2-025-435-TH00
 XX-XXX-XXX-XXX-XXXX

PLUG	RECEPTACLE
SERIES	

NM .025" Metal I/O Connector	NK .025" Metal PC Board Mounted Connector
------------------------------	---

BODY	
-------------	--

2 2-Row BODY STYLE: 1 Plug, straight 5 Plug, straight, with factory installed backshell (See page NA-3) BODY MATERIAL: 2 Liquid Crystal Polymer w/ electroless nickel shell 3 Liquid Crystal Polymer w/ electrodeposited cadmium shell <input checked="" type="checkbox"/>	2 2-Row BODY STYLE: F Receptacle, right angle, plated thru hole (PTH) BODY MATERIAL: 2 Liquid Crystal Polymer w/ electroless nickel shell 3 Liquid Crystal Polymer w/ electrodeposited cadmium shell <input checked="" type="checkbox"/>
--	---

SIZE	
-------------	--

XXX Number of contacts (009, 015, 021, 025, 031, 037, 051, 065, 069, 085 or 091)	XXX Number of contacts (009, 015, 021, 025, 031, 037, 051, 065, 069, 085 or 091)
--	--

CONTACTS	
-----------------	--

TYPE CONTACTS/TERMINATIONS: 16 Pin, straight, crimped wire PLATING OPTIONS: 1 50 u" Au contacts	TYPE CONTACTS/TERMINATIONS: 43 Socket, right angle, .109" 44 Socket, right angle, .140" 45 Socket, right angle, .172" PLATING OPTIONS: 5 50 u" Au contacts; Sn/Pb alloy terminations <input checked="" type="checkbox"/> 8 50 u" Au contacts; Tin plated terminations
--	---

HARDWARE	
-----------------	--

STYLE OF HARDWARE: 00 None JC Turning jackscrews, captivated #0-80 UNF* WIRING OPTIONS: XX See wiring codes, Page NA-2	STYLE OF HARDWARE: 00 None TH Threaded hole, #0-80 UNF* WIRING OPTIONS: 00 None
--	---

* = #2-56 UNC thread on 85 and 91 position connectors
 .050 hex key (#0-80 thread)
 1/16" hex key (#2-56 thread)
 Recommended torque value 1.0 inch-lbs. max. (#0-80 thread)
 Recommended torque value 2.0 inch-lbs. max. (#2-56 thread)
 Ball end hex wrench not recommended
 Hex wrench key/bit conforming to the requirements of ASME / ANSI-B-18.3 is recommended.
 .050" hex L-key long arm wrench - order AirBorn p/n CDG14148.
 1/16" hex L-key long arm wrench - order AirBorn p/n CDG14160.

= Option not RoHS compliant



Recommended PC Board Layout

Right Angle PTH Plug
FOR REFERENCE ONLY

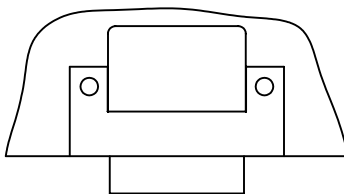

PC BOARD LAYOUT
COMPONENT SIDE

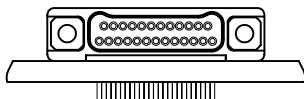
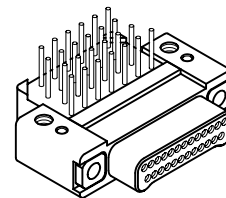

CONNECTOR MATING FACE

9 POSITION

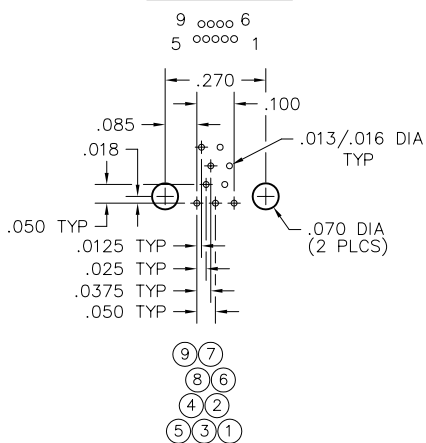

15 POSITION

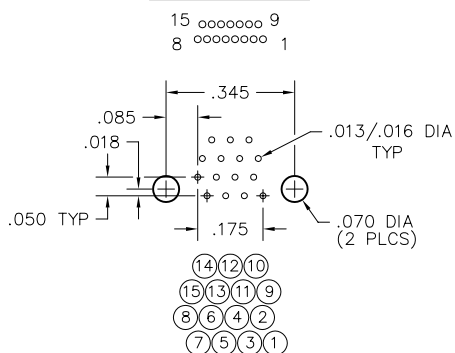

21 POSITION

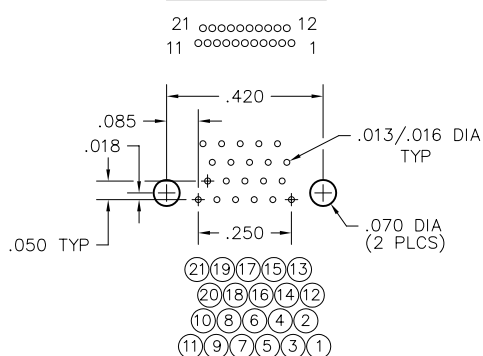

25 POSITION

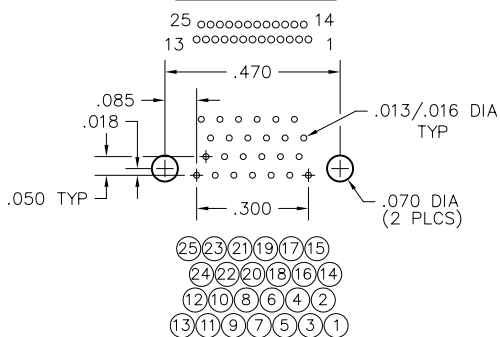

31 POSITION

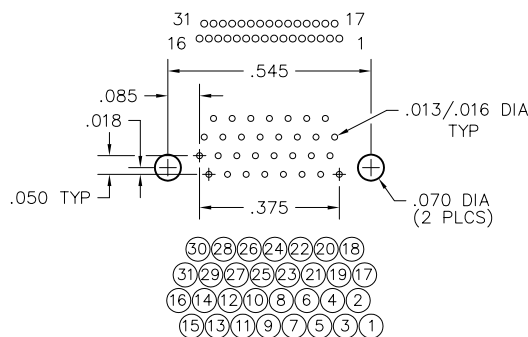

37 POSITION

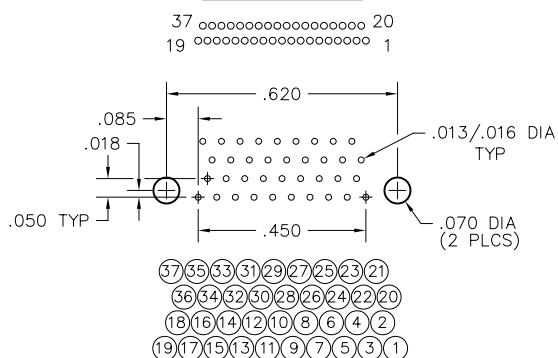

51 POSITION

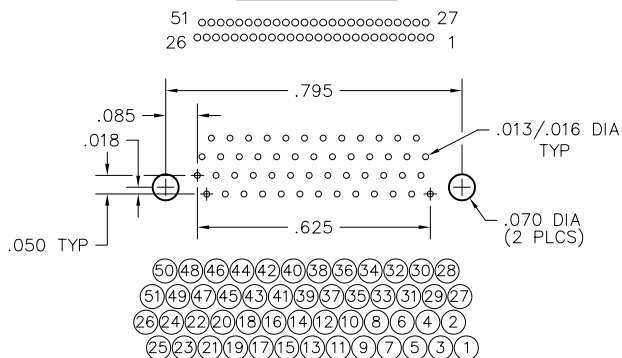

Recommended PC Board Layout

Right Angle PTH Plug
FOR REFERENCE ONLY

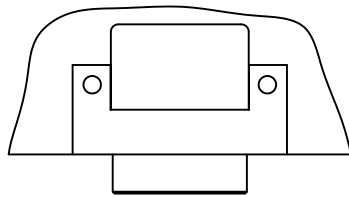

PC BOARD LAYOUT
COMPONENT SIDE

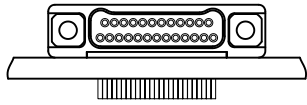
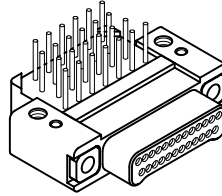

CONNECTOR MATING FACE

65 POSITION

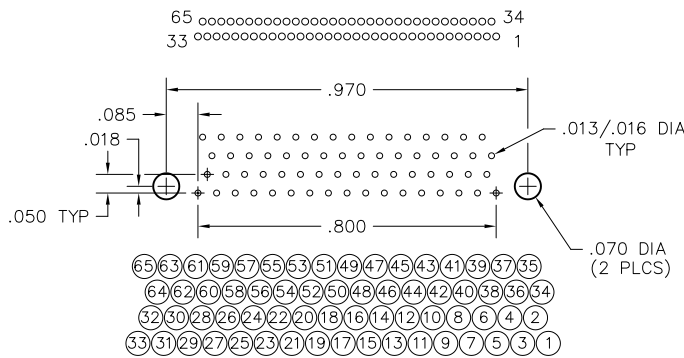

69 POSITION

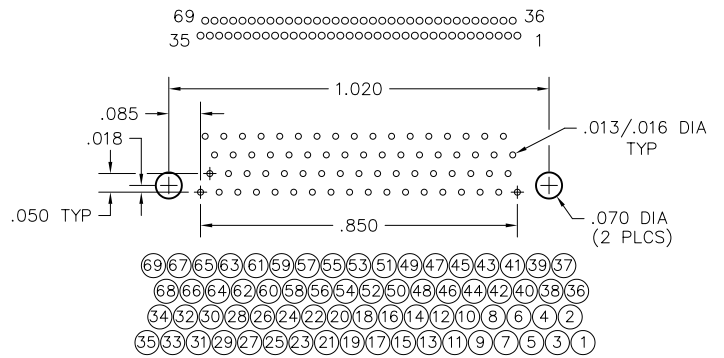

85 POSITION

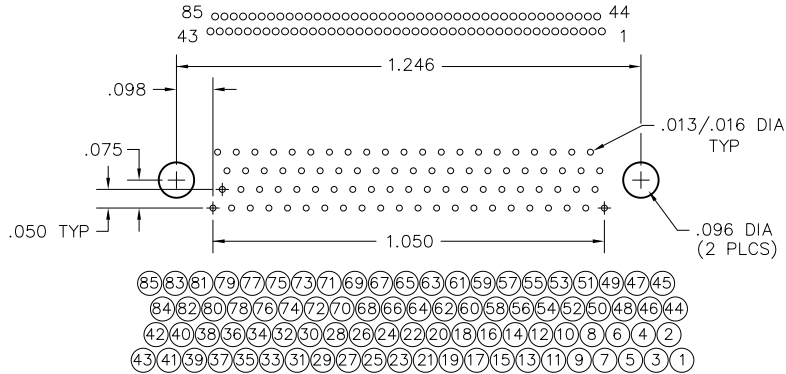

91 POSITION

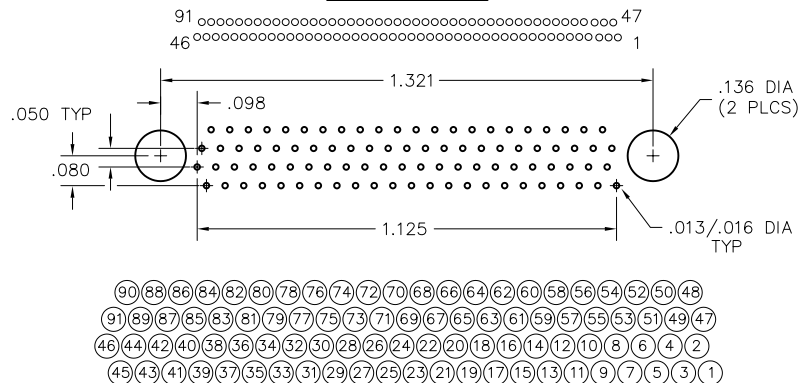



Recommended PC Board Layout

Right Angle PTH Receptacle
FOR REFERENCE ONLY

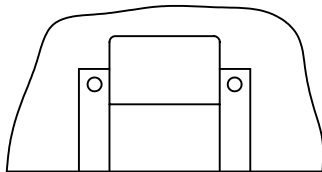

PC BOARD LAYOUT
COMPONENT SIDE

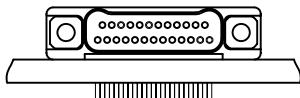
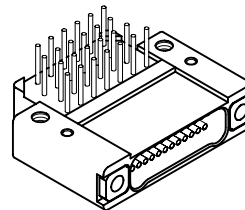

CONNECTOR MATING FACE

9 POSITION

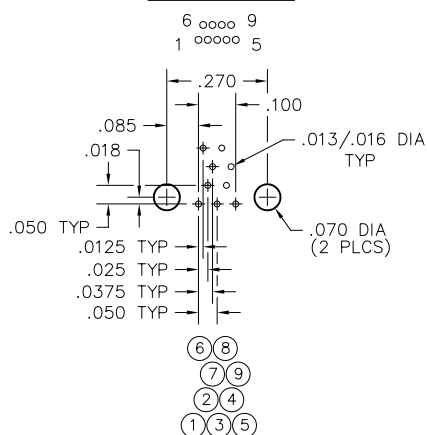

15 POSITION

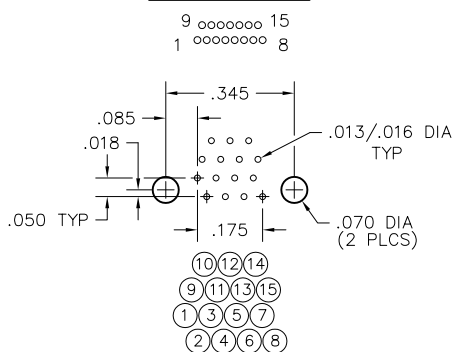

21 POSITION

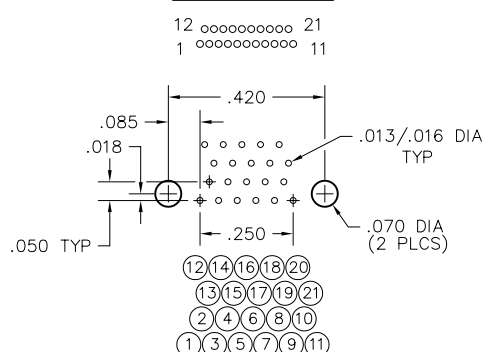

25 POSITION

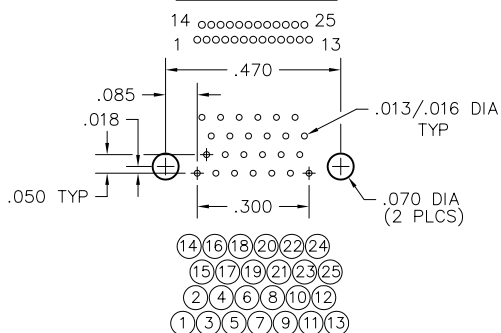

31 POSITION

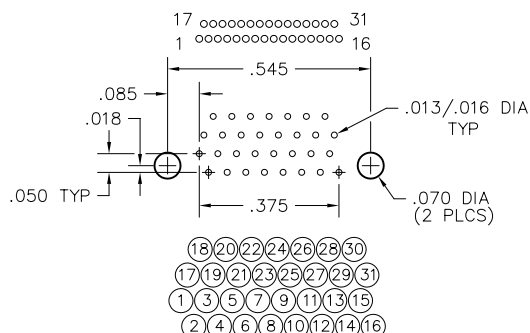

37 POSITION

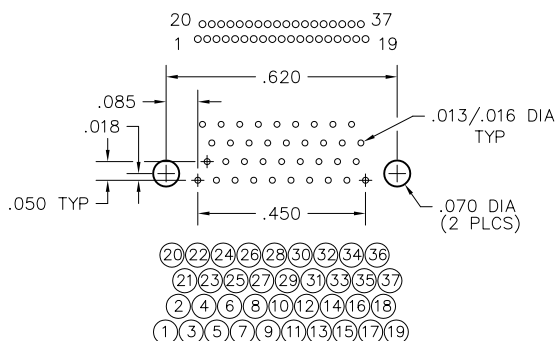

51 POSITION

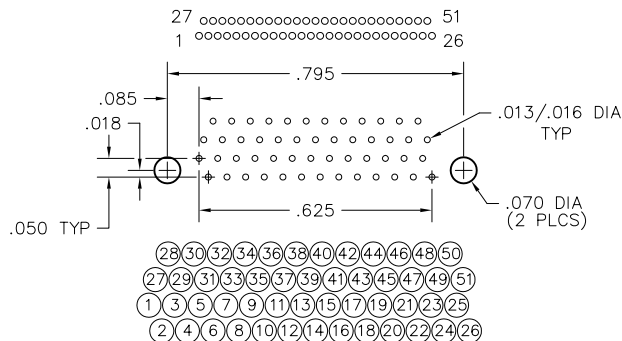

Recommended PC Board Layout

Right Angle PTH Receptacle
FOR REFERENCE ONLY

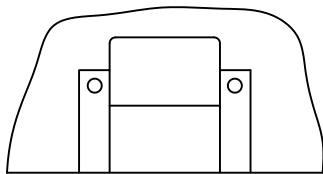

PC BOARD LAYOUT
COMPONENT SIDE

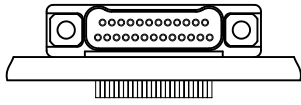
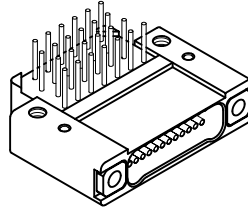

CONNECTOR MATING FACE

65 POSITION

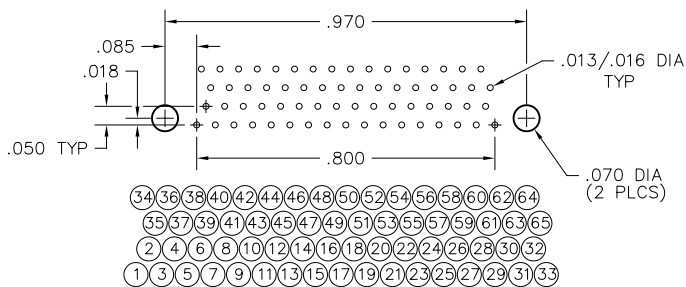
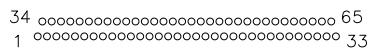

69 POSITION

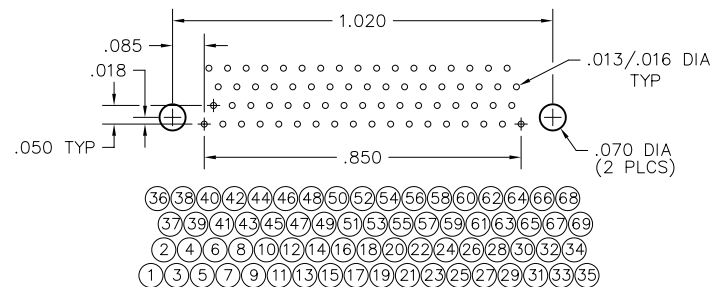
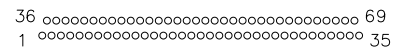

85 POSITION

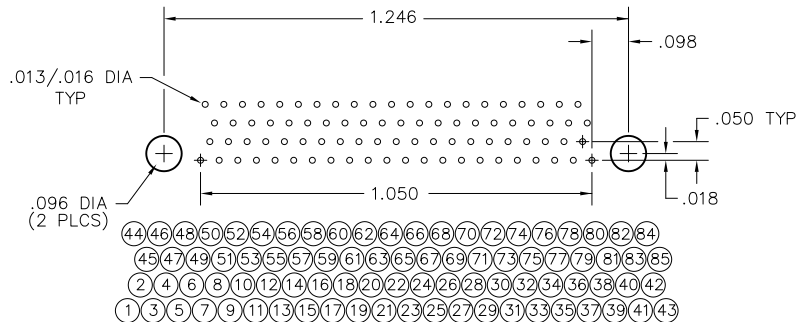
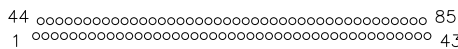

91 POSITION

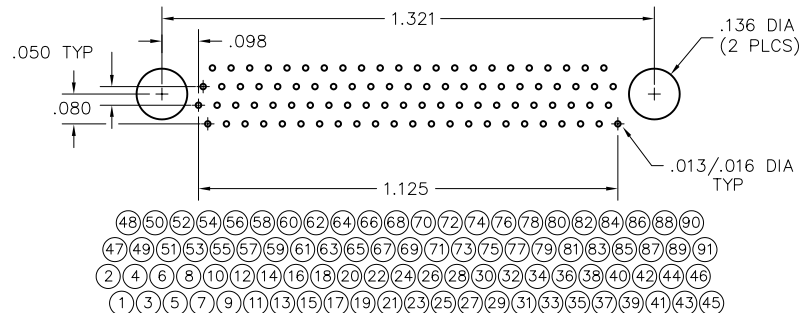
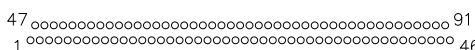

2 · ROW Vertical PTH Plug with Fixed Hardware

.025"

NK

9 thru 91 Contacts

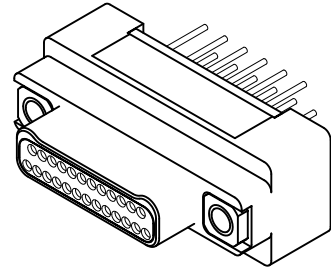
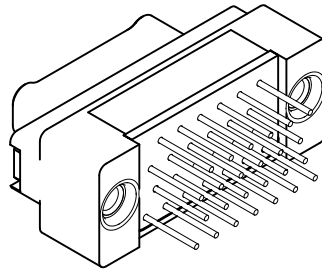

NK-2G2-025-135-TH00
PLUG

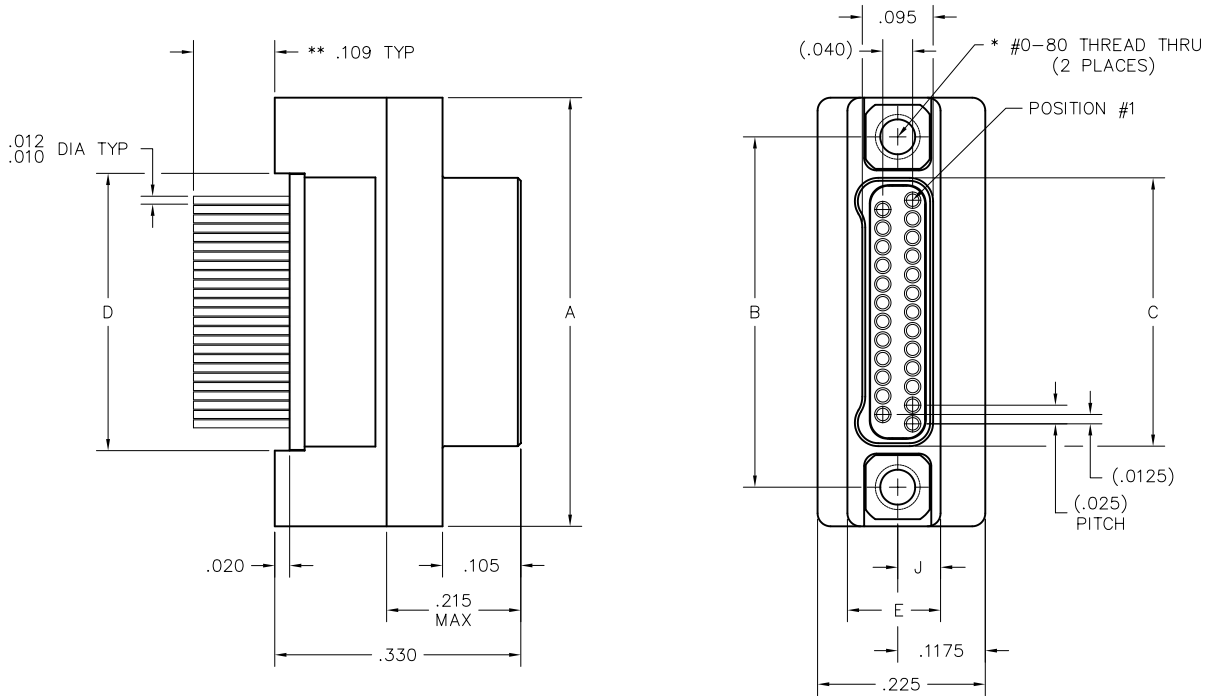

DIMENSIONS							
SIZE	A	B	C	D	E	J	*HARDWARE
9	.375	.270	.160	.170			
15	.450	.345	.235	.245			
21	.525	.420	.310	.320			
25	.575	.470	.360	.370			
31	.650	.545	.435	.445	.125	.0575	#0-80 THREAD
37	.725	.620	.510	.520			
51	.900	.795	.685	.695			
65	1.075	.970	.860	.870			
69	1.125	1.020	.910	.920			
85	1.377	1.246	1.110	1.120	.150	.070	#2-56 THREAD
91	1.452	1.321	1.184	1.198			

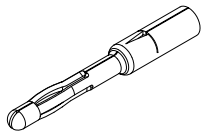

PIN CONTACT
3 TINE SPRING MEMBER, CRIMP

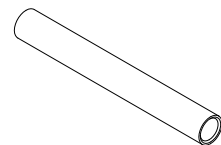

SOCKET CONTACT
DRAWN TUBE, CRIMP

* = #2-56 UNC THREAD ON 85 AND 91 POSITION CONNECTORS.
** = OTHER LENGTHS AS REQUIRED

NK-2G2-025-135-TH00
 XX-XXX-XXX-XXX-XXXX

SERIES

NK .025" Metal PC Board Mounted Connector

BODY

2 2-Row

BODY STYLE:

G Plug, vertical mount, plated thru hole (PTH)

BODY MATERIAL:

- 2 Liquid Crystal Polymer w/ electroless nickel shell
- 3 Liquid Crystal Polymer w/ electrodeposited cadmium shell

SIZE

XXX Number of contacts (009, 015, 021, 025, 031, 037, 051, 065, 069, 085 or 091)

CONTACTS

TYPE CONTACTS/TERMINATIONS:

- 13 Pin, straight, .109"
- 14 Pin, straight, .140"
- 15 Pin, straight, .172"

PLATING OPTIONS:

- 5 50 u" Au contacts; Sn/Pb alloy terminations
- 8 50 u" Au contacts; Tin plated terminations

HARDWARE

STYLE OF HARDWARE:

- 00 None
- TH Threaded hole, #0-80 UNF *

WIRING OPTIONS:

- 00 None

* = #2-56 UNC thread on 85 and 91 position connectors
 .050 hex key (#0-80 thread)
 1/16" hex key (#2-56 thread)
 Recommended torque value 1.0 inch-lbs. max. (#0-80 thread)
 Recommended torque value 2.0 inch-lbs. max. (#2-56 thread)
 Ball end hex wrench not recommended
 Hex wrench key/bit conforming to the requirements of ASME / ANSI-B-18.3 is recommended.
 .050" hex L-key long arm wrench - order AirBorn p/n CDG14148.
 1/16" hex L-key long arm wrench - order AirBorn p/n CDG14160.

= Option not RoHS compliant



Recommended PC Board Layout

Vertical PTH Plug
FOR REFERENCE ONLY

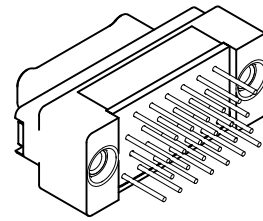
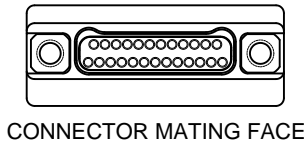

9 POSITION

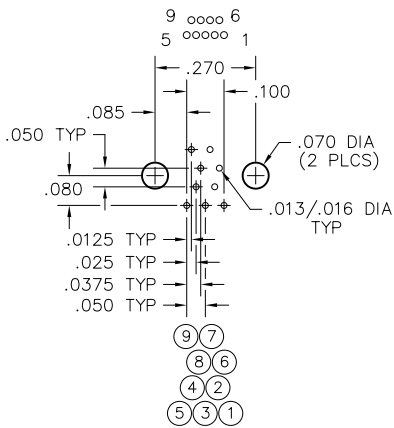

15 POSITION

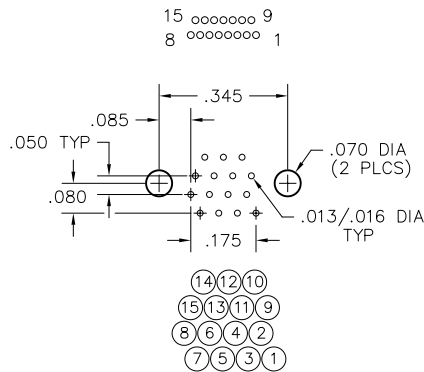

21 POSITION

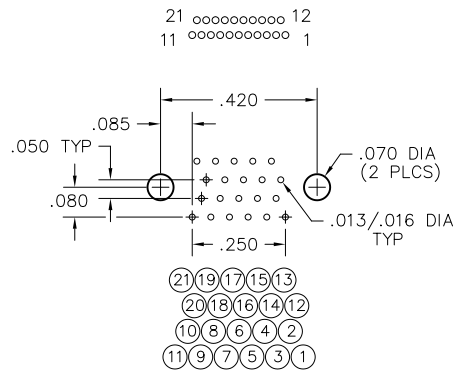

25 POSITION

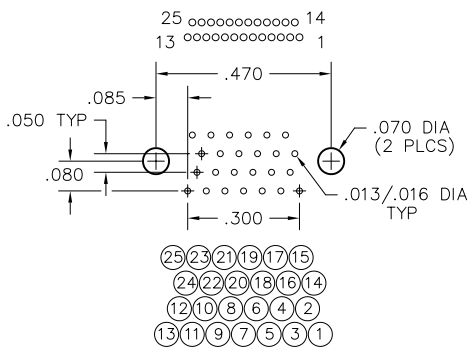

31 POSITION

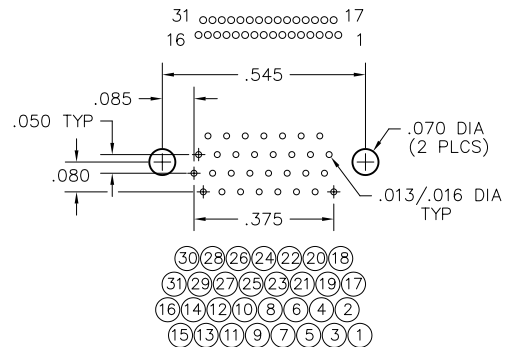

37 POSITION

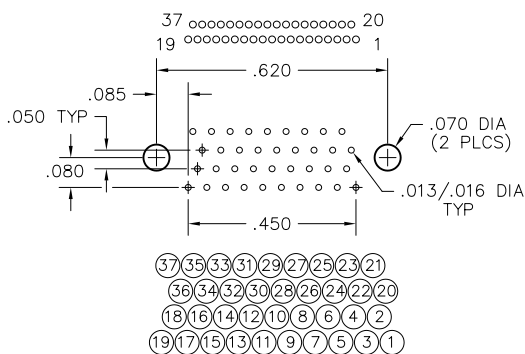

51 POSITION

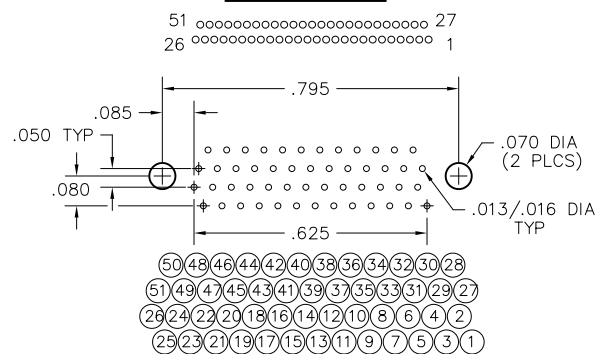

Recommended PC Board Layout

Vertical PTH Plug
FOR REFERENCE ONLY

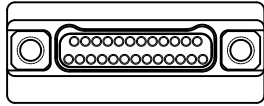

CONNECTOR MATING FACE

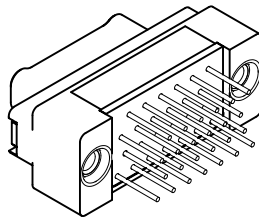

65 POSITION

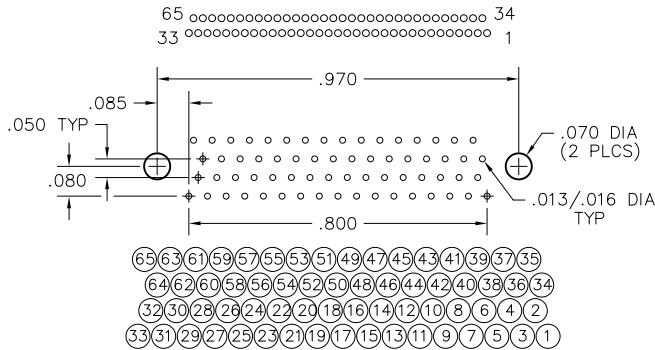

69 POSITION

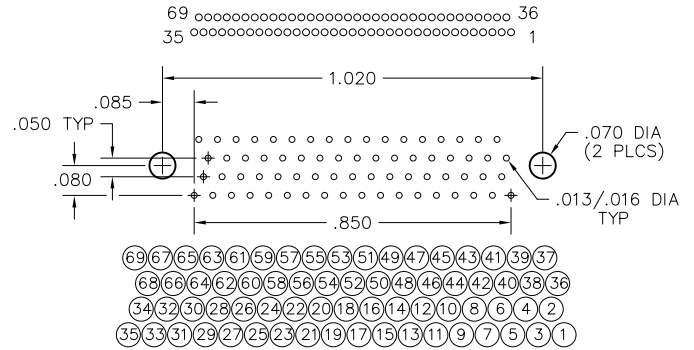

85 POSITION

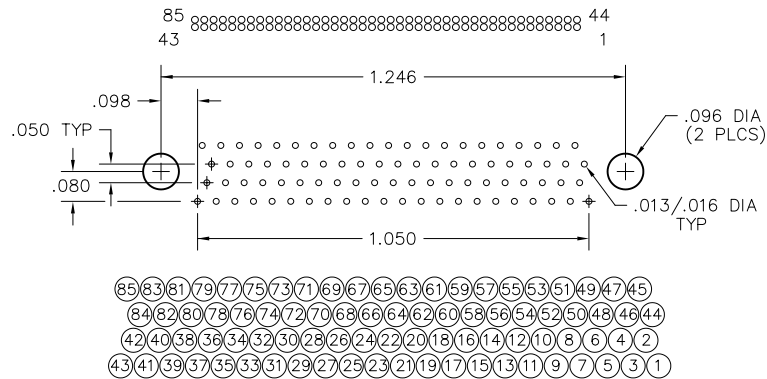

91 POSITION

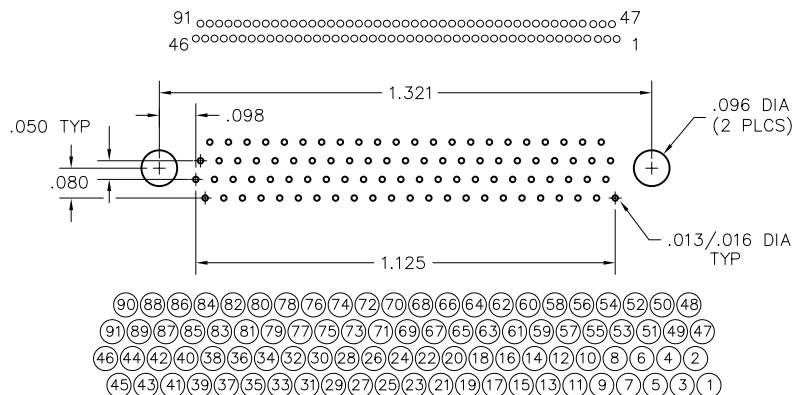

2 · ROW Vertical PTH Receptacle with Fixed Hardware

.025"

NK

9 thru 91 Contacts

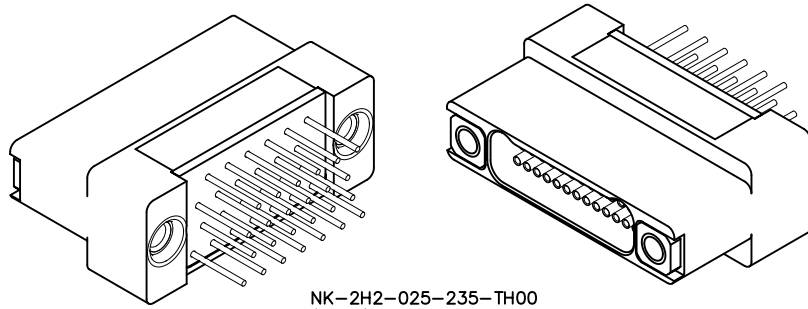

NK-2H2-025-235-TH00
(RCPT)

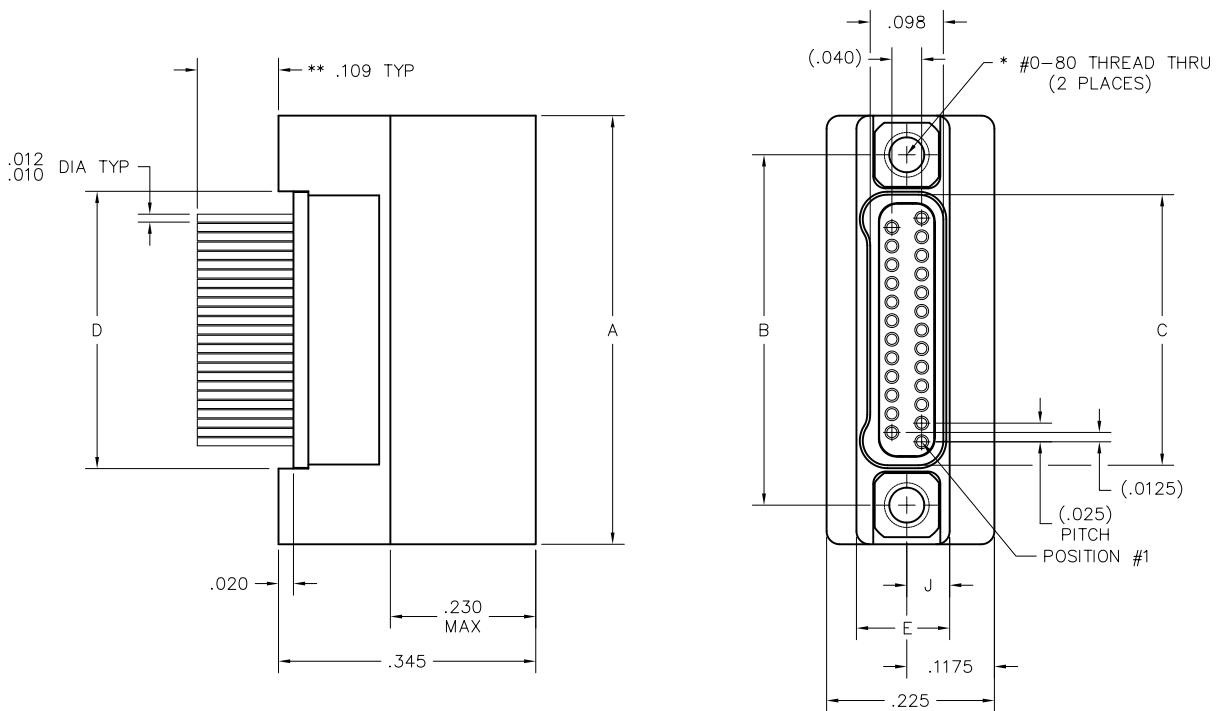

DIMENSIONS							
SIZE	A	B	C	D	E	J	*HARDWARE
9	.375	.270	.163	.170	.125	.0575	#0-80 THREAD
15	.450	.345	.238	.245			
21	.525	.420	.313	.320			
25	.575	.470	.363	.370			
31	.650	.545	.438	.445			
37	.725	.620	.513	.520			
51	.900	.795	.688	.695			
65	1.075	.970	.863	.870	.150	.070	#2-56 THREAD
69	1.125	1.020	.913	.920			
85	1.377	1.246	1.113	1.120			
91	1.452	1.321	1.184	1.198			

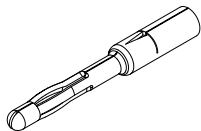

PIN CONTACT
3 TINE SPRING MEMBER, CRIMP

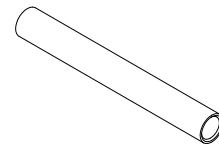

SOCKET CONTACT
DRAWN TUBE, CRIMP

* = #2-56 UNC THREAD ON 85 AND 91 POSITION CONNECTORS.
** = OTHER LENGTHS AS REQUIRED

NK-2H2-025-235-TH00
 XX-XXX-XXX-XXX-XXXX

SERIES

NK .025" Metal PC Board Mounted Connector

BODY

2 2-Row

BODY STYLE:

H Receptacle, vertical mount, plated thru hole (PTH)

BODY MATERIAL:

- 2 Liquid Crystal Polymer w/ electroless nickel shell
- 3 Liquid Crystal Polymer w/ electrodeposited cadmium shell

SIZE

XXX Number of contacts (009, 015, 021, 025, 031, 037, 051, 065, 069, 085 or 091)

CONTACTS

TYPE CONTACTS/TERMINATIONS:

- 23 Socket, straight, .109"
- 24 Socket, straight, .140"
- 25 Socket, straight, .172"

PLATING OPTIONS:

- 5 50 u" Au contacts; Sn/Pb alloy terminations
- 8 50 u" Au contacts; Tin plated terminations

HARDWARE

STYLE OF HARDWARE:

- 00 None
- TH Threaded hole, #0-80 UNF *

WIRING OPTIONS:

- 00 None

* = #2-56 UNC thread on 85 and 91 position connectors
 .050 hex key (#0-80 thread)
 1/16" hex key (#2-56 thread)
 Recommended torque value 1.0 inch-lbs. max. (#0-80 thread)
 Recommended torque value 2.0 inch-lbs. max. (#2-56 thread)
 Ball end hex wrench not recommended
 Hex wrench key/bit conforming to the requirements of ASME / ANSI-B-18.3 is recommended.
 .050" hex L-key long arm wrench - order AirBorn p/n CDG14148.
 1/16" hex L-key long arm wrench - order AirBorn p/n CDG14160.

= Option not RoHS compliant



Recommended PC Board Layout

Vertical PTH Receptacle
FOR REFERENCE ONLY

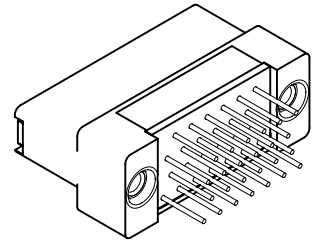
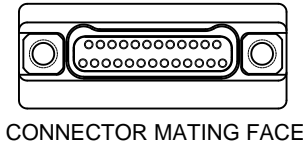

9 POSITION

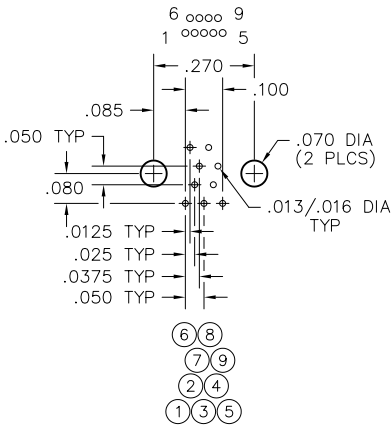

15 POSITION

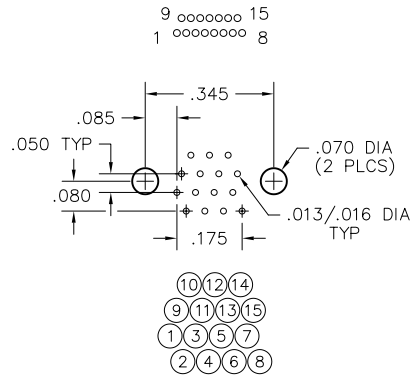

21 POSITION

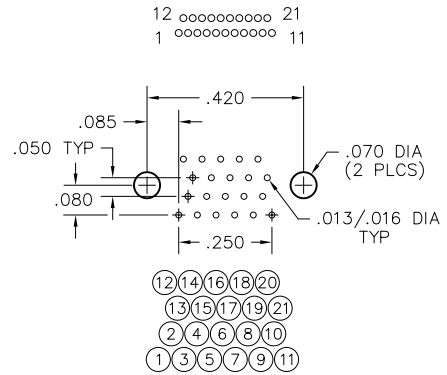

25 POSITION

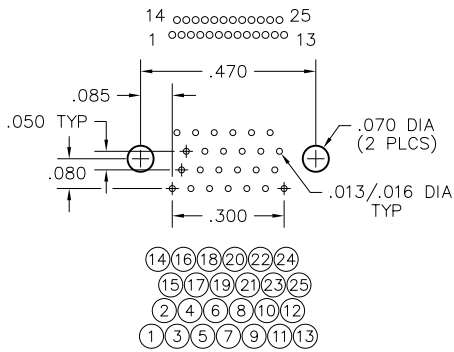

31 POSITION

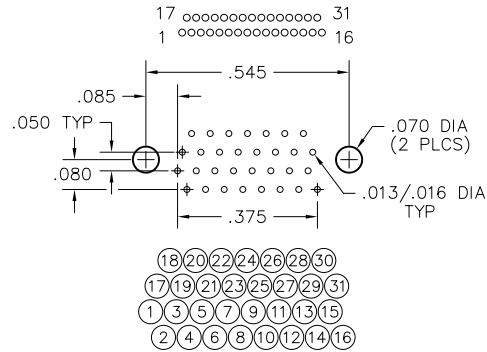

37 POSITION

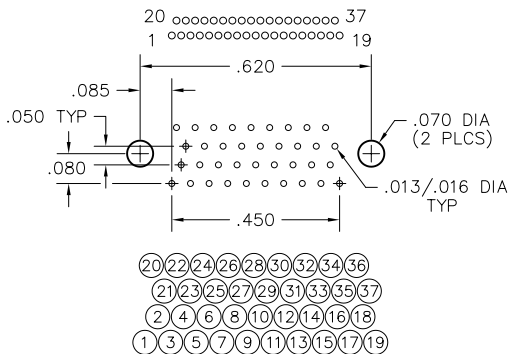

51 POSITION

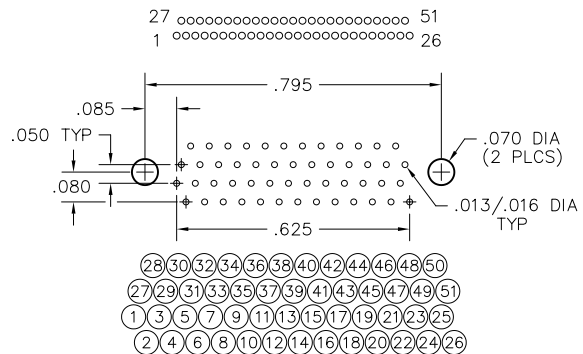

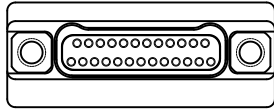

CONNECTOR MATING FACE

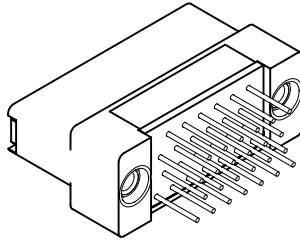

Recommended PC Board Layout

Vertical PTH Receptacle
FOR REFERENCE ONLY

65 POSITION

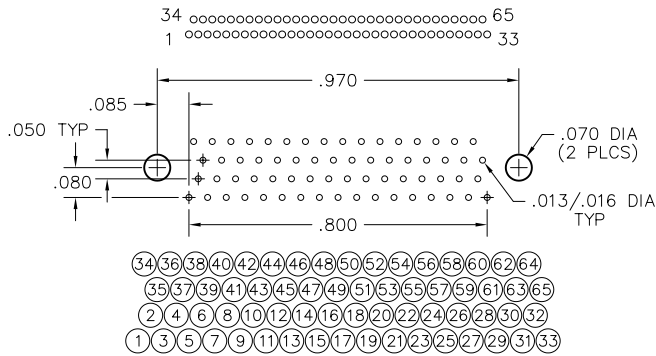

69 POSITION

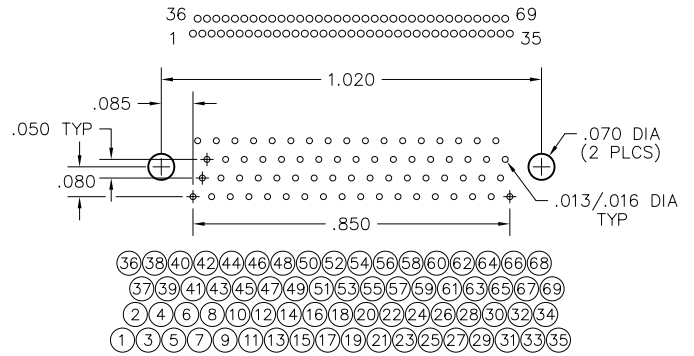

85 POSITION

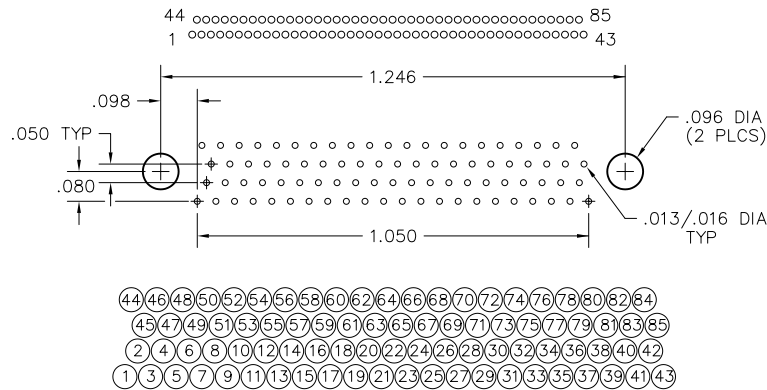

91 POSITION

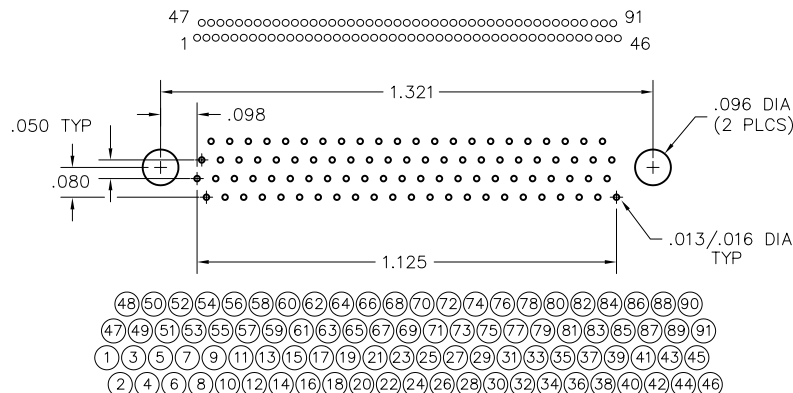

2 · ROW Vertical PTH Plug with Turning Hardware

.025"

NK

9 thru 91 Contacts

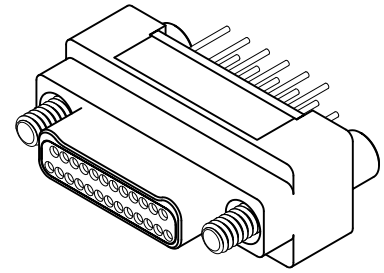
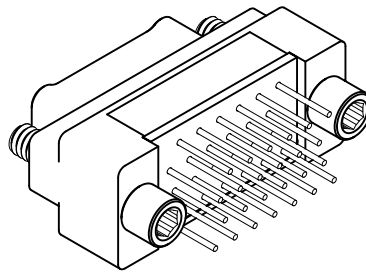

NK-2G2-025-135-JC00
PLUG

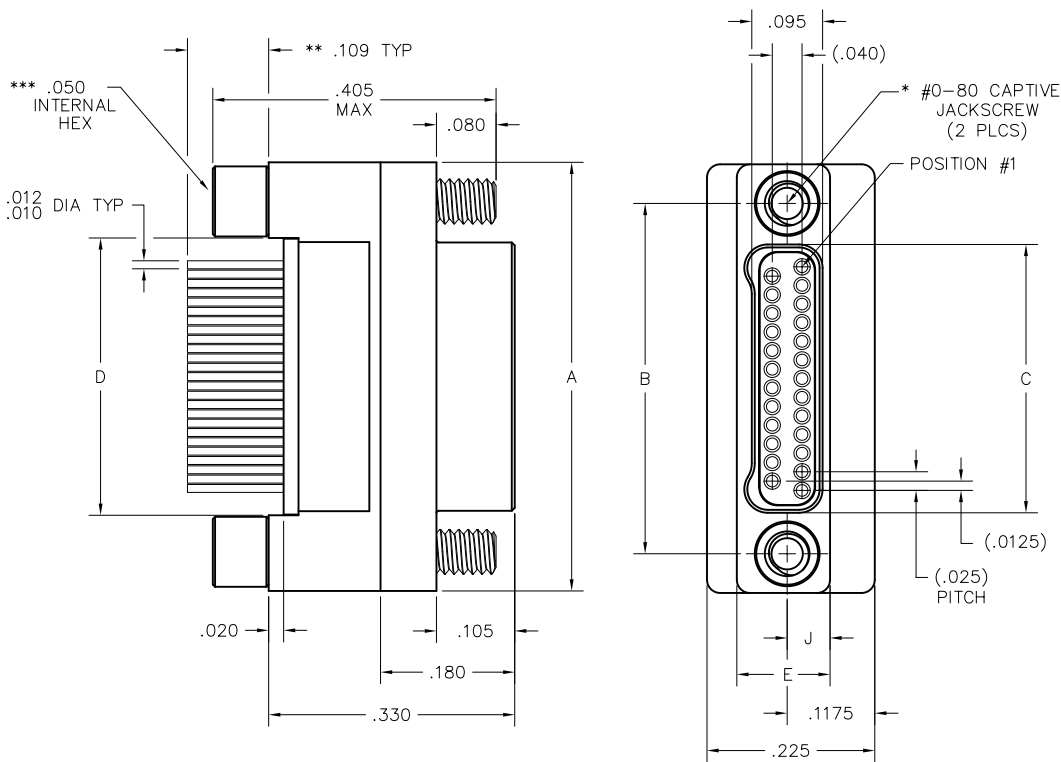

DIMENSIONS							
SIZE	A	B	C	D	E	J	*HARDWARE
9	.375	.270	.160	.170			
15	.450	.345	.235	.245			
21	.525	.420	.310	.320			
25	.575	.470	.360	.370			
31	.650	.545	.435	.445	.125	.0575	#0-80 THREAD
37	.725	.620	.510	.520			
51	.900	.795	.685	.695			
65	1.075	.970	.860	.870			
69	1.125	1.020	.910	.920			
85	1.377	1.246	1.110	1.120	.150	.070	#2-56 THREAD
91	1.451	1.321	1.184	1.198			

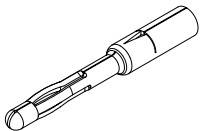

PIN CONTACT
3 TINE SPRING MEMBER, CRIMP

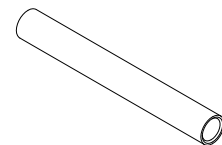

SOCKET CONTACT
DRAWN TUBE, CRIMP

- * = #2-56 UNC THREAD ON 85 AND 91 POSITION CONNECTORS.
- ** = OTHER LENGTHS AS REQUIRED
- *** = 1/16" HEX ON 85 POSITION CONNECTORS. HEX MEASUREMENT TAKEN ACROSS THE FLATS.

NK-2G2-025-135-JC00
 XX-XXX-XXX-XXX-XXXX

SERIES

NK .025" Metal PC Board Mounted Connector

BODY

2 2-Row

BODY STYLE:

G Plug, vertical mount, plated thru hole (PTH)

BODY MATERIAL:

- 2 Liquid Crystal Polymer w/ electroless nickel shell
- 3 Liquid Crystal Polymer w/ electrodeposited cadmium shell

SIZE

XXX Number of contacts (009, 015, 021, 025, 031, 037, 051, 065, 069, 085 or 091)

CONTACTS

TYPE CONTACTS/TERMINATIONS:

- 13 Pin, straight, .109"
- 14 Pin, straight, .140"
- 15 Pin, straight, .172"

PLATING OPTIONS:

- 5 50 u" Au contacts; Sn/Pb alloy terminations
- 8 50 u" Au contacts; Tin plated terminations

HARDWARE

STYLE OF HARDWARE:

JC #0-80 captive jackscrew *

WIRING OPTIONS:

00 None

* = #2-56 UNC thread on 85 and 91 position connectors
 .050 hex key (#0-80 thread)
 1/16" hex key (#2-56 thread)
 Recommended torque value 1.0 inch-lbs. max. (#0-80 thread)
 Recommended torque value 2.0 inch-lbs. max. (#2-56 thread)
 Ball end hex wrench not recommended
 Hex wrench key/bit conforming to the requirements of ASME / ANSI-B-18.3 is recommended.
 .050" hex L-key long arm wrench - order AirBorn p/n CDG14148.
 1/16" hex L-key long arm wrench - order AirBorn p/n CDG14160.

= Option not RoHS compliant



Recommended PC Board Layout

Vertical PTH Plug
with turning hardware
FOR REFERENCE ONLY

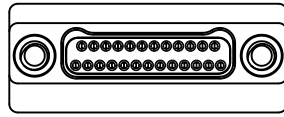

CONNECTOR MATING FACE

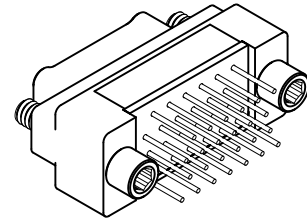

9 POSITION

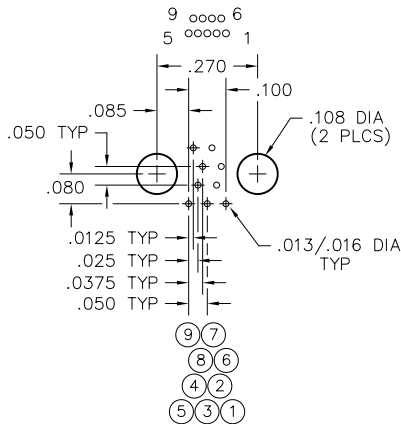

15 POSITION

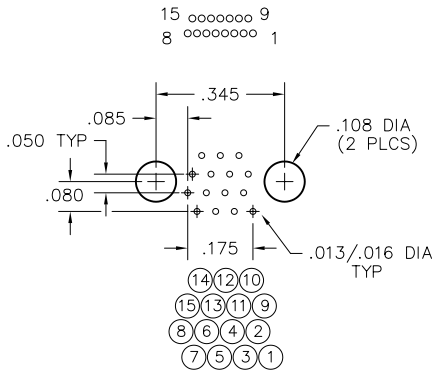

21 POSITION

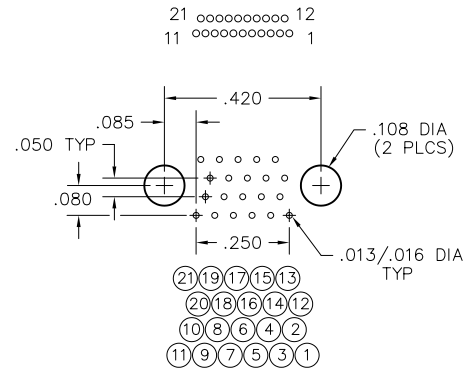

25 POSITION

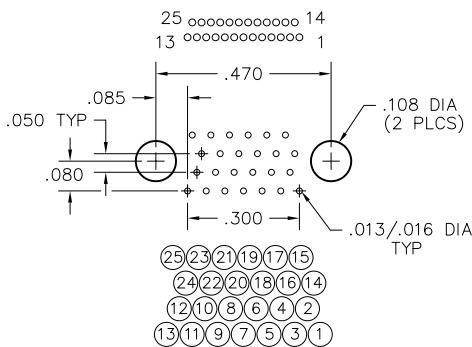

31 POSITION

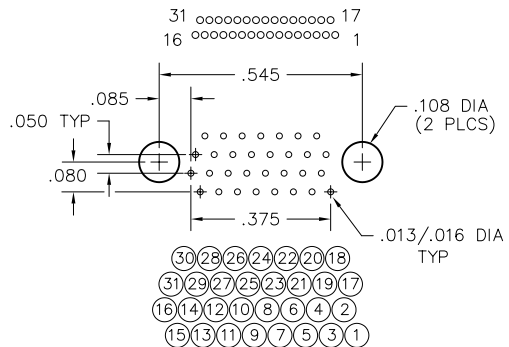

37 POSITION

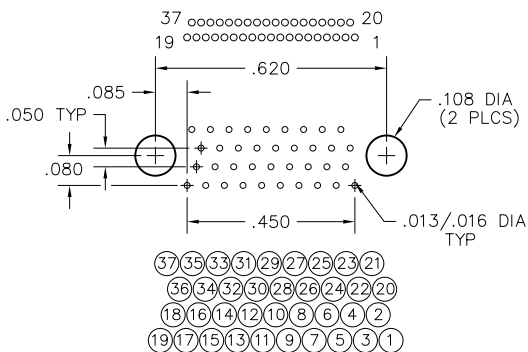

51 POSITION

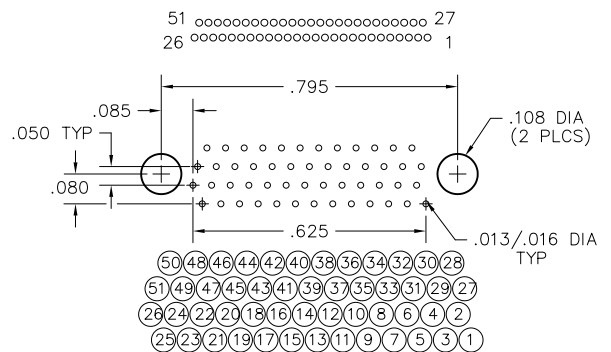

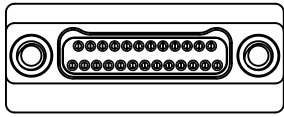

CONNECTOR MATING FACE

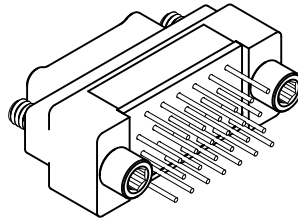

Recommended PC Board Layout

Vertical PTH Plug
with turning hardware
FOR REFERENCE ONLY

65 POSITION

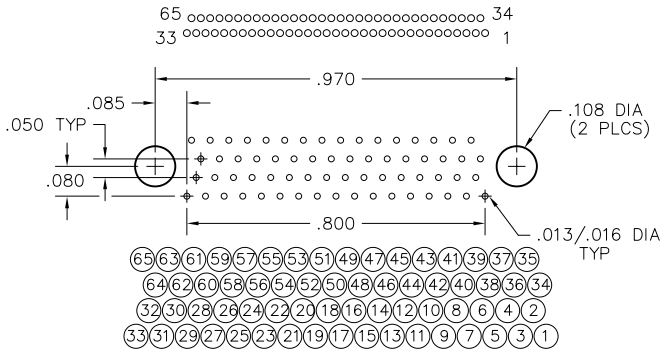

69 POSITION

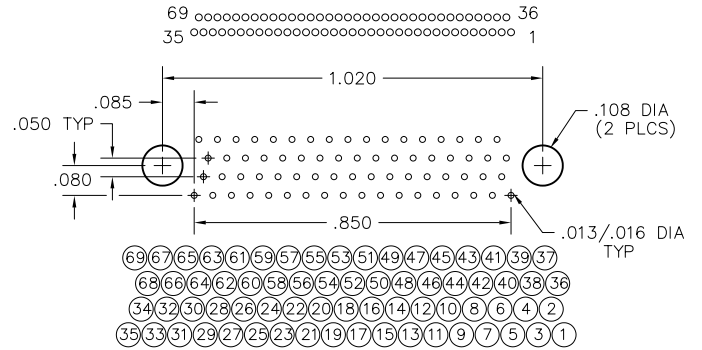

85 POSITION

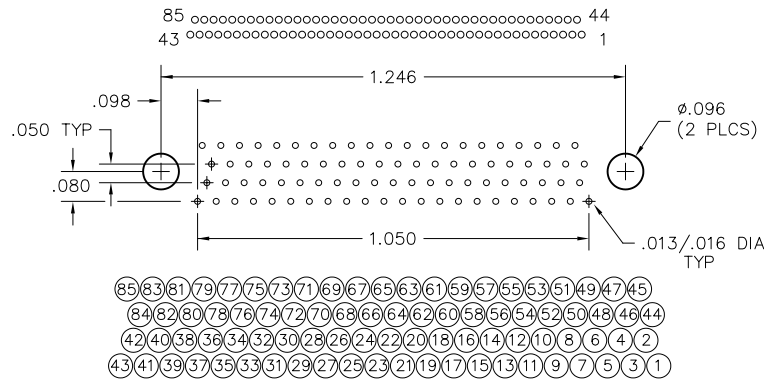

91 POSITION

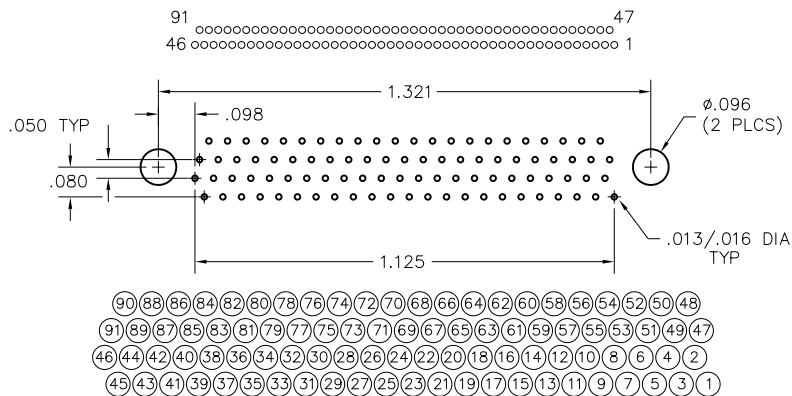

2 · ROW Vertical PTH Receptacle with Turning Hardware

.025"

NK

9 thru 91 Contacts

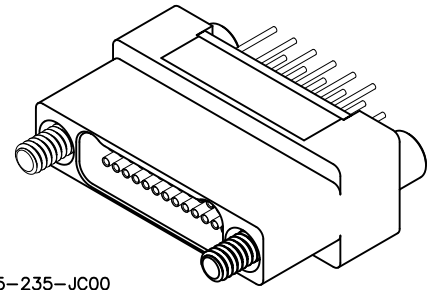
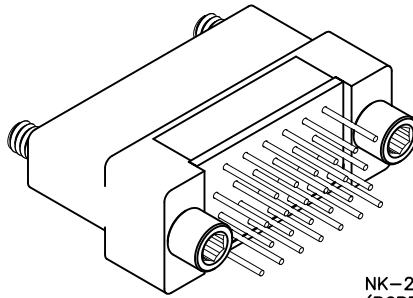

NK-2H2-025-235-JC00
(RCPT)

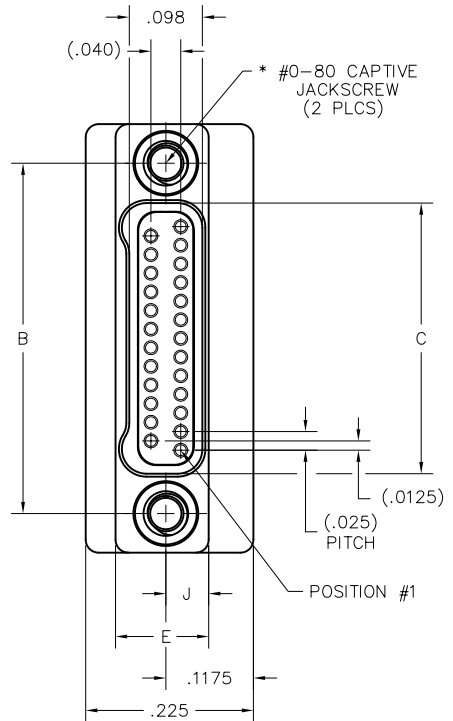
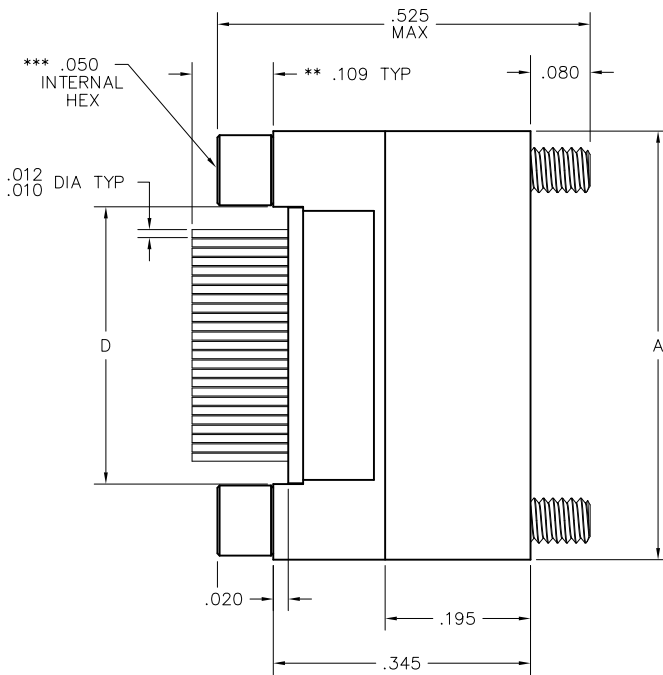

DIMENSIONS							
SIZE	A	B	C	D	E	J	*HARDWARE
9	.375	.270	.163	.170	.125	.0575	#0-80 THREAD
15	.450	.345	.238	.245			
21	.525	.420	.313	.320			
25	.575	.470	.363	.370			
31	.650	.545	.438	.445			
37	.725	.620	.513	.520			
51	.900	.795	.688	.695			
65	1.075	.970	.863	.870			
69	1.125	1.020	.913	.920	.150	.070	#2-56 THREAD
85	1.377	1.246	1.113	1.120			
91	1.452	1.321	1.188	1.197			

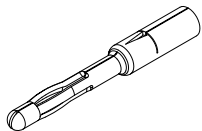

PIN CONTACT
3 TINE SPRING MEMBER, CRIMP

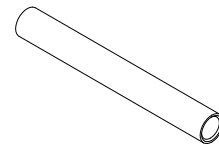

SOCKET CONTACT
DRAWN TUBE, CRIMP

- * = #2-56 UNC THREAD ON 85 AND 91 POSITION CONNECTORS.
- ** = OTHER LENGTHS AS REQUIRED
- *** = 1/16" HEX ON 85 POSITION CONNECTORS. HEX MEASUREMENT TAKEN ACROSS THE FLATS.

NK-2H2-025-235-JC00
 XX-XXX-XXX-XXX-XXXX

SERIES

NK .025" Metal PC Board Mounted Connector

BODY

2 2-Row

BODY STYLE:

H Receptacle, vertical mount, plated thru hole (PTH)

BODY MATERIAL:

- 2 Liquid Crystal Polymer w/ electroless nickel shell
- 3 Liquid Crystal Polymer w/ electrodeposited cadmium shell

SIZE

XXX Number of contacts (009, 015, 021, 025, 031, 037, 051, 065, 069, 085 or 091)

CONTACTS

TYPE CONTACTS/TERMINATIONS:

- 23 Socket, straight, .109"
- 24 Socket, straight, .140"
- 25 Socket, straight, .172"

PLATING OPTIONS:

- 5 50 u" Au contacts; Sn/Pb alloy terminations
- 8 50 u" Au contacts; Tin plated terminations

HARDWARE

STYLE OF HARDWARE:

JC #0-80 captive jackscrew *

WIRING OPTIONS:

00 None

* = #2-56 UNC thread on 85 and 91 position connectors
 .050 hex key (#0-80 thread)
 1/16" hex key (#2-56 thread)
 Recommended torque value 1.0 inch-lbs. max. (#0-80 thread)
 Recommended torque value 2.0 inch-lbs. max. (#2-56 thread)
 Ball end hex wrench not recommended
 Hex wrench key/bit conforming to the requirements of ASME / ANSI-B-18.3 is recommended.
 .050" hex L-key long arm wrench - order AirBorn p/n CDG14148.
 1/16" hex L-key long arm wrench - order AirBorn p/n CDG14160.

= Option not RoHS compliant



Recommended PC Board Layout

Vertical PTH Receptacle with turning hardware
FOR REFERENCE ONLY

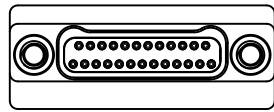

CONNECTOR MATING FACE

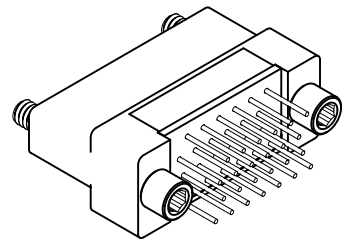

9 POSITION

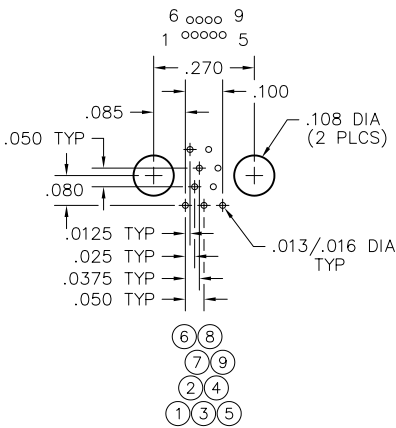

15 POSITION

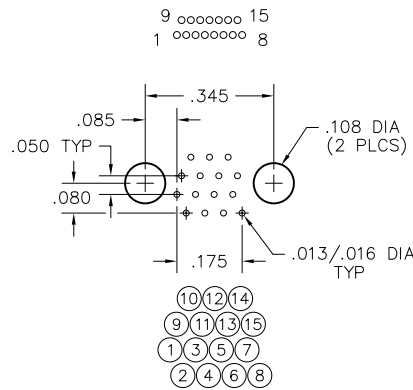

21 POSITION

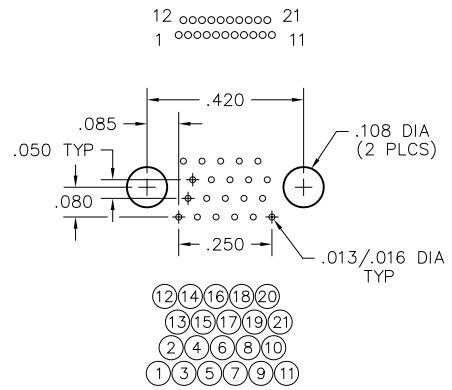

25 POSITION

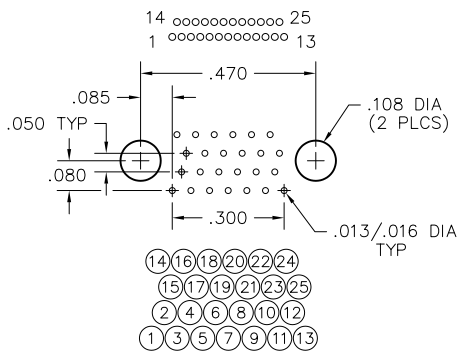

31 POSITION

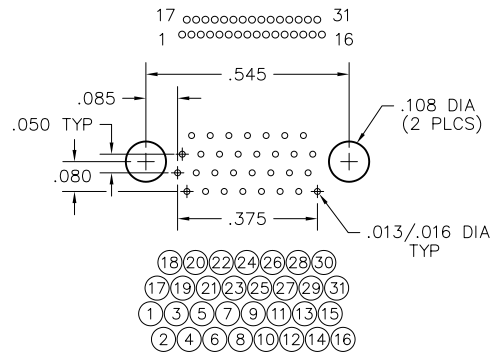

37 POSITION

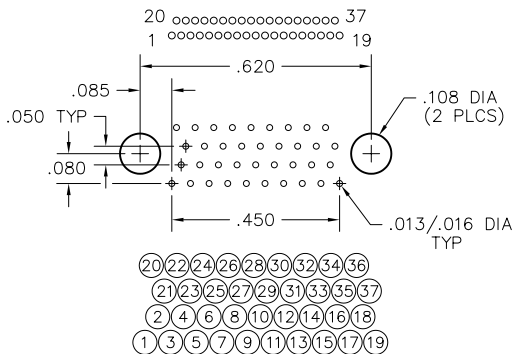

51 POSITION

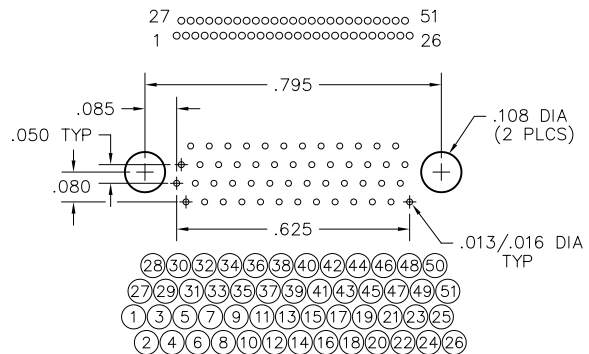

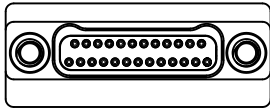

CONNECTOR MATING FACE

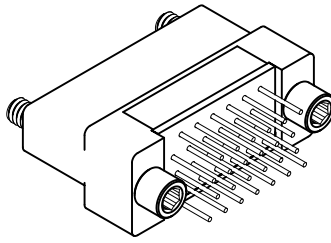

Recommended PC Board Layout

Vertical PTH Receptacle with turning hardware
FOR REFERENCE ONLY

65 POSITION

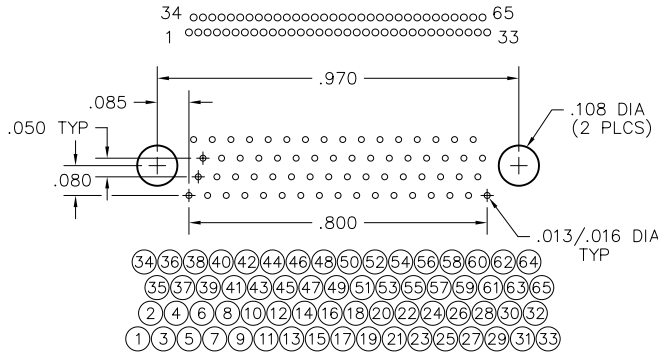

69 POSITION

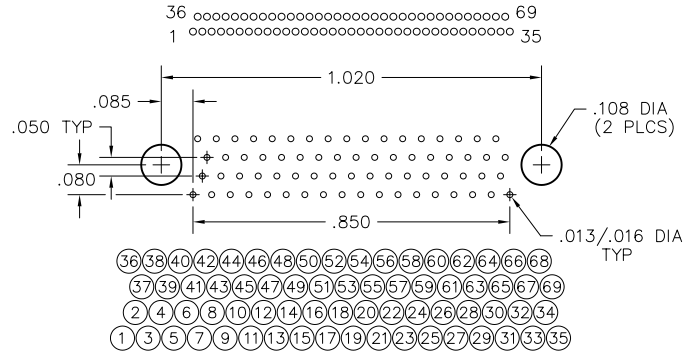

85 POSITION

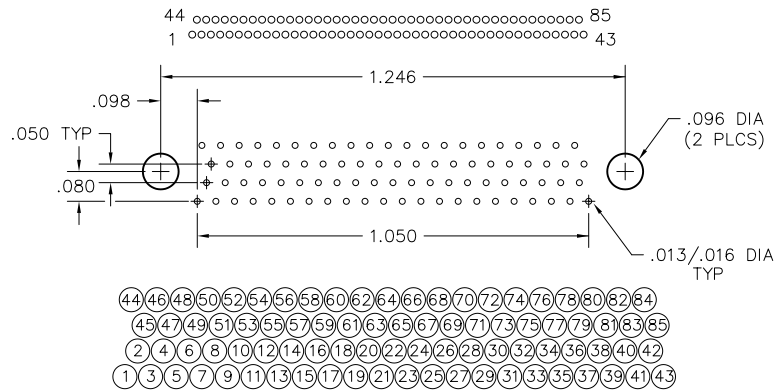

91 POSITION

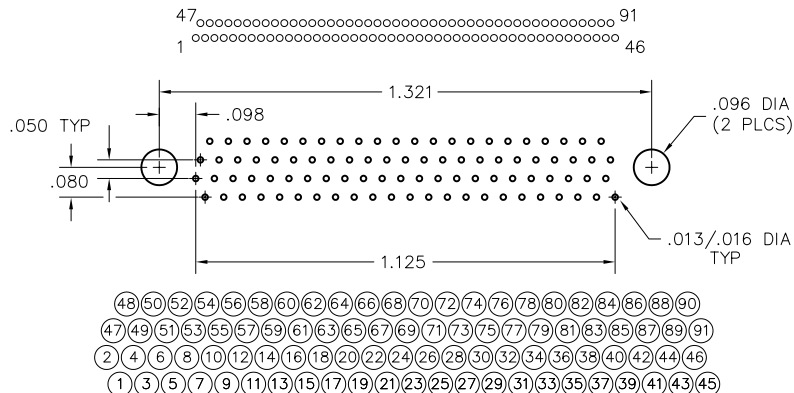

2 · ROW Vertical PTH Plug with Turning Hardware and Mounting Ears

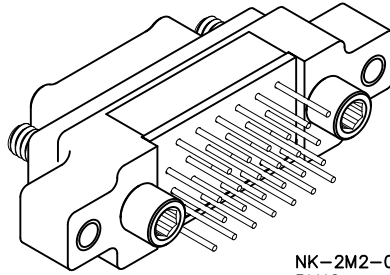

NK-2M2-025-135-JC00
PLUG

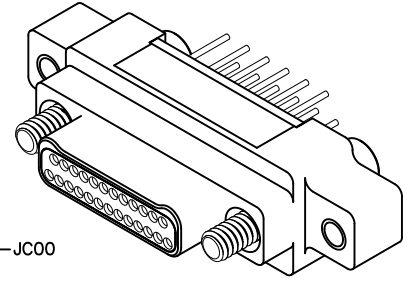

.025"

NK

9 thru 85 Contacts

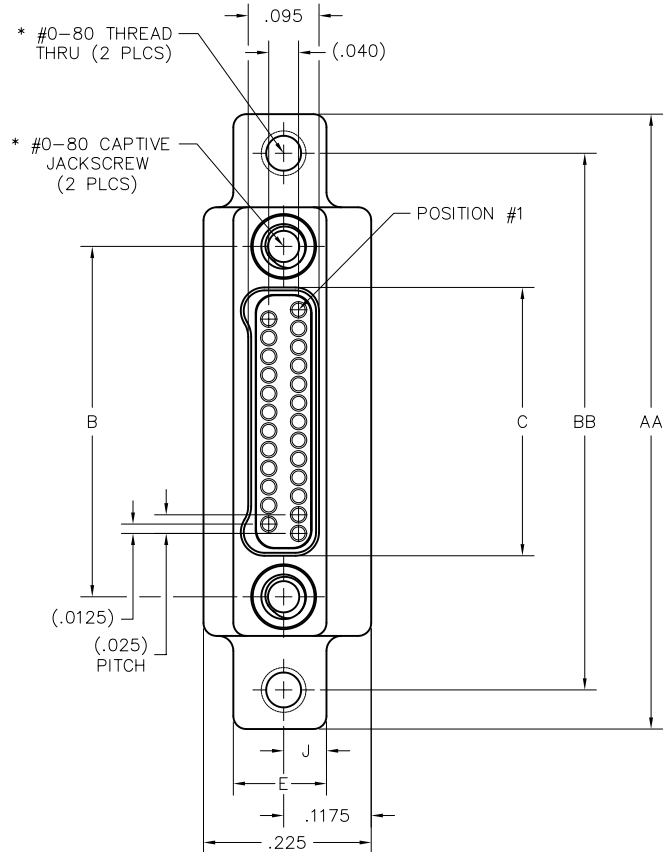
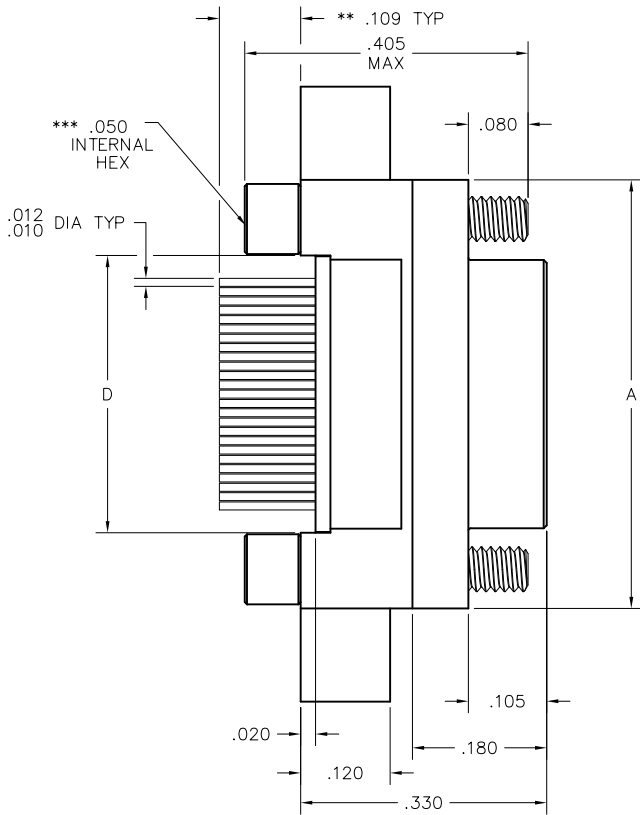

DIMENSIONS									
SIZE	A	B	AA	BB	C	D	E	J	*HARDWARE
9	.375	.270	.625	.520	.160	.170			
15	.450	.345	.700	.595	.235	.245			
21	.525	.420	.775	.670	.310	.320			
25	.575	.470	.825	.720	.360	.370			
31	.650	.545	.900	.795	.435	.445	.125	.0575	#0-80 THREAD
37	.725	.620	.975	.870	.510	.520			
51	.900	.795	1.150	1.045	.685	.695			
65	1.075	.970	1.325	1.220	.860	.870			
69	1.125	1.020	1.375	1.270	.910	.920			
85	1.377	1.246	1.679	1.546	1.110	1.120	.150	.070	#2-56 THREAD

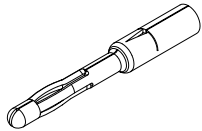

PIN CONTACT
3 TINE SPRING MEMBER, CRIMP

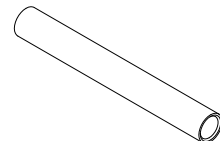

SOCKET CONTACT
DRAWN TUBE, CRIMP

* = #2-56 UNC THREAD ON 85 POSITION CONNECTORS.
 ** = OTHER LENGTHS AS REQUIRED
 *** = 1/16" HEX ON 85 POSITION CONNECTORS. HEX MEASUREMENT
 TAKEN ACROSS THE FLATS.

NK-2M2-025-135-JC00
 XX-XXX-XXX-XXX-XXXX

SERIES

NK .025" Metal PC Board Mounted Connector

BODY

2 2-Row

BODY STYLE:

M Plug, vertical mount, plated thru hole (PTH) with mounting ears

BODY MATERIAL:

- 2 Liquid Crystal Polymer w/ electroless nickel shell
- 3 Liquid Crystal Polymer w/ electrodeposited cadmium shell

SIZE

XXX Number of contacts (009, 015, 021, 025, 031, 037, 051, 065, 069 or 085)

CONTACTS

TYPE CONTACTS/TERMINATIONS:

- 13 Pin, straight, .109"
- 14 Pin, straight, .140"
- 15 Pin, straight, .172"

PLATING OPTIONS:

- 5 50 u" Au contacts; Sn/Pb alloy terminations
- 8 50 u" Au contacts; Tin plated terminations

HARDWARE

STYLE OF HARDWARE:

JC #0-80 captive jackscrew *

WIRING OPTIONS:

00 None

* = #2-56 UNC thread on 85 position connectors

- .050 hex key (#0-80 thread)
- 1/16" hex key (#2-56 thread)

Recommended torque value 1.0 inch-lbs. max. (#0-80 thread)

Recommended torque value 2.0 inch-lbs. max. (#2-56 thread)

Ball end hex wrench not recommended

Hex wrench key/bit conforming to the requirements of ASME / ANSI-B-18.3 is recommended.

.050" hex L-key long arm wrench - order AirBorn p/n CDG14148.

1/16" hex L-key long arm wrench - order AirBorn p/n CDG14160.

= Option not RoHS compliant



Recommended PC Board Layout

Vertical PTH Plug
with turning hardware
and mounting ears
FOR REFERENCE ONLY

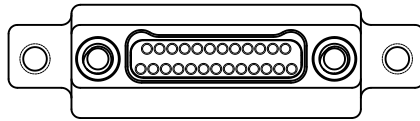

CONNECTOR MATING FACE

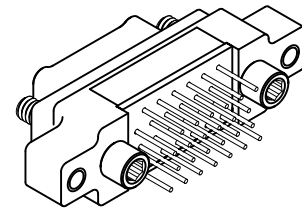

9 POSITION

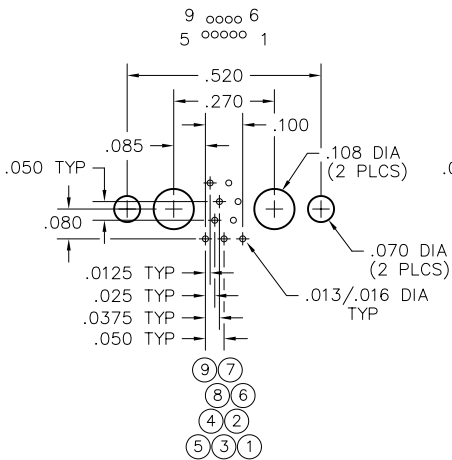

15 POSITION

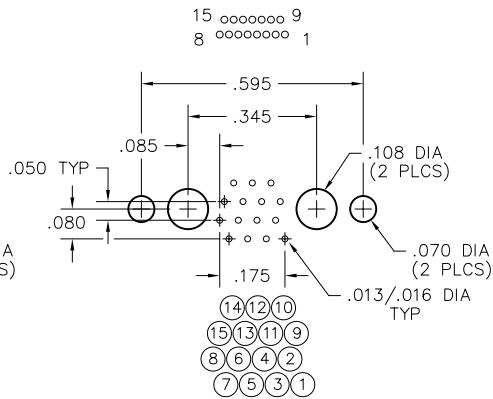

21 POSITION

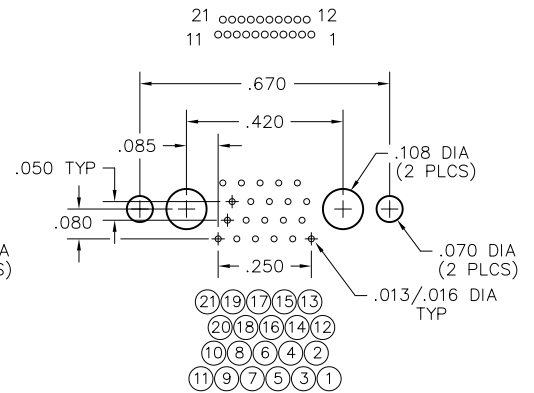

25 POSITION

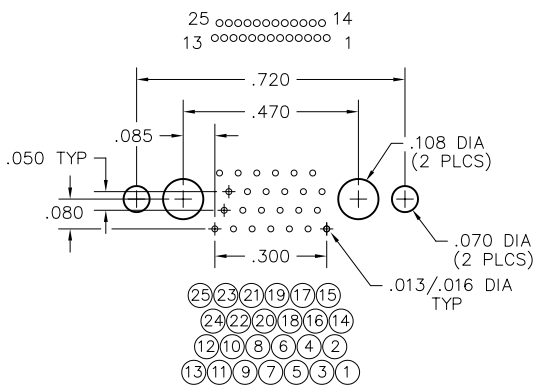

31 POSITION

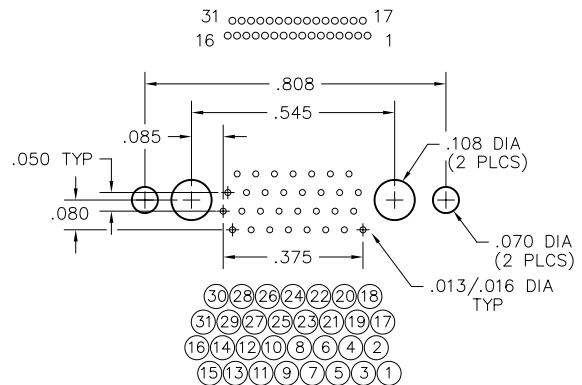

37 POSITION

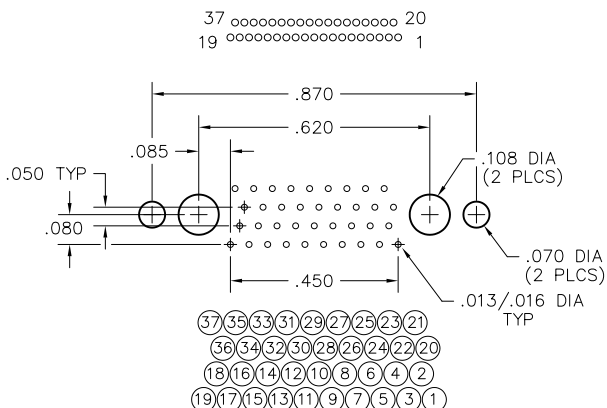

51 POSITION

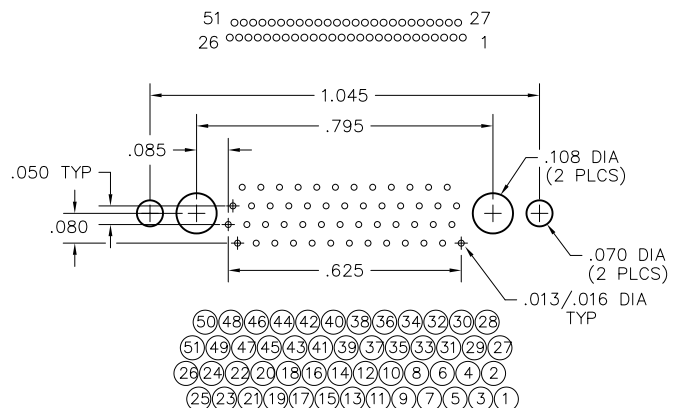

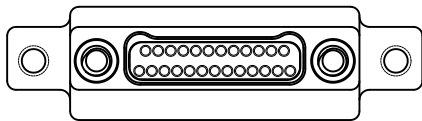

CONNECTOR MATING FACE

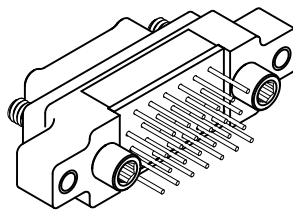

Recommended PC Board Layout

Vertical PTH Plug
with turning hardware
and mounting ears
FOR REFERENCE ONLY

65 POSITION

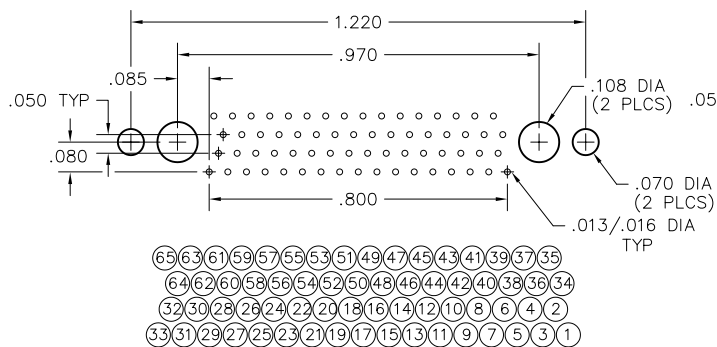
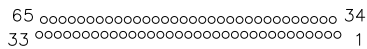

69 POSITION

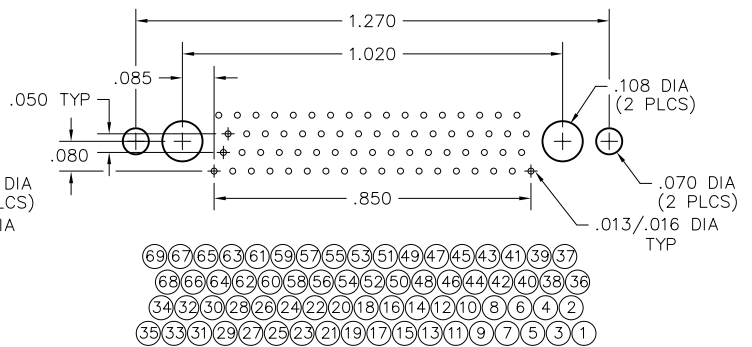
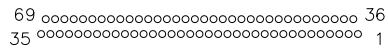

85 POSITION

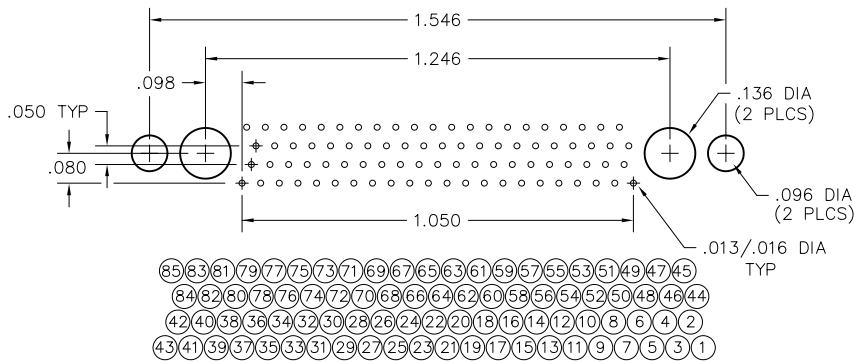
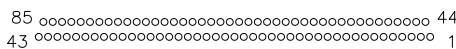

2 · ROW Vertical PTH Receptacle with Turning Hardware and Mounting Ears

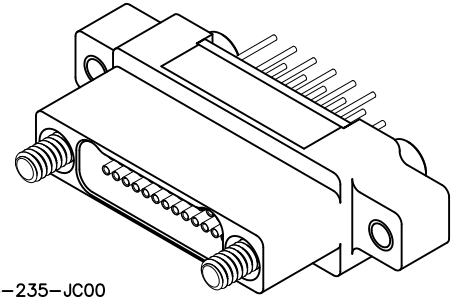
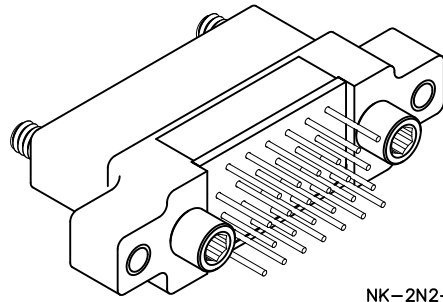

NK-2N2-025-235-JC00
RECEPTACLE

.025"

NK

9 thru 85 Contacts

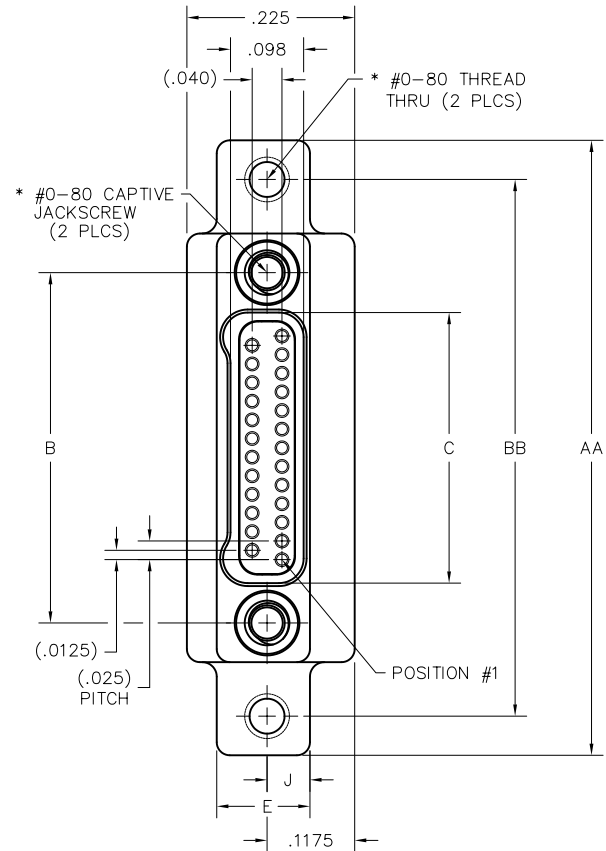
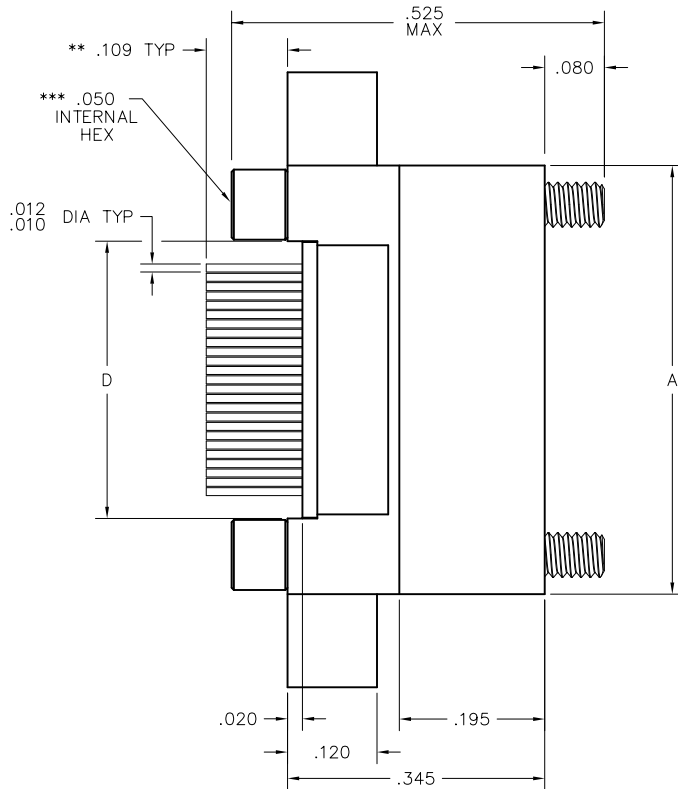

DIMENSIONS									
SIZE	A	B	AA	BB	C	D	E	J	*HARDWARE
9	.375	.270	.625	.520	.163	.170			
15	.450	.345	.700	.595	.238	.245			
21	.525	.420	.775	.670	.313	.320			
25	.575	.470	.825	.720	.363	.370			
31	.650	.545	.900	.795	.438	.445	.125	.0575	#0-80 THREAD
37	.725	.620	.975	.870	.513	.520			
51	.900	.795	1.150	1.045	.688	.695			
65	1.075	.970	1.325	1.220	.863	.870			
69	1.125	1.020	1.375	1.270	.913	.920			
85	1.377	1.246	1.679	1.546	1.113	1.120	.150	.070	#2-56 THREAD

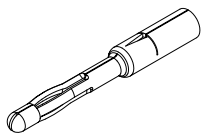

PIN CONTACT
3 TINE SPRING MEMBER, CRIMP

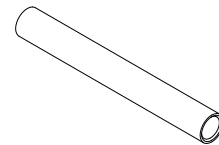

SOCKET CONTACT
DRAWN TUBE, CRIMP

- * = #2-56 UNC THREAD ON 85 POSITION CONNECTORS.
- ** = OTHER LENGTHS AS REQUIRED
- *** = 1/16" HEX ON 85 POSITION CONNECTORS. HEX MEASUREMENT TAKEN ACROSS THE FLATS.

NK-2N2-025-235-JC00
 XX-XXX-XXX-XXX-XXXX

SERIES

NK .025" Metal PC Board Mounted Connector

BODY

2 2-Row

BODY STYLE:

N Receptacle, vertical mount, plated thru hole (PTH) with mounting ears

BODY MATERIAL:

- 2 Liquid Crystal Polymer w/ electroless nickel shell
- 3 Liquid Crystal Polymer w/ electrodeposited cadmium shell

SIZE

XXX Number of contacts (009, 015, 021, 025, 031, 037, 051, 065, 069 or 085)

CONTACTS

TYPE CONTACTS/TERMINATIONS:

- 23 Socket, straight, .109"
- 24 Socket, straight, .140"
- 25 Socket, straight, .172"

PLATING OPTIONS:

- 5 50 u" Au contacts; Sn/Pb alloy terminations
- 8 50 u" Au contacts; Tin plated terminations

HARDWARE

STYLE OF HARDWARE:

JC #0-80 captive jackscrew *

WIRING OPTIONS:

00 None

* = #2-56 UNC thread on 85 position connectors
 .050 hex key (#0-80 thread)
 1/16" hex key (#2-56 thread)
 Recommended torque value 1.0 inch-lbs. max. (#0-80 thread)
 Recommended torque value 2.0 inch-lbs. max. (#2-56 thread)
 Ball end hex wrench not recommended
 Hex wrench key/bit conforming to the requirements of ASME / ANSI-B-18.3 is recommended.
 .050" hex L-key long arm wrench - order AirBorn p/n CDG14148.
 1/16" hex L-key long arm wrench - order AirBorn p/n CDG14160.

= Option not RoHS compliant



Recommended PC Board Layout

Vertical PTH Receptacle with turning hardware and mounting ears
FOR REFERENCE ONLY

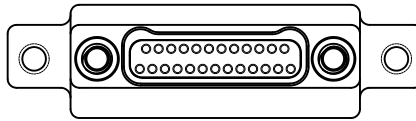

CONNECTOR MATING FACE

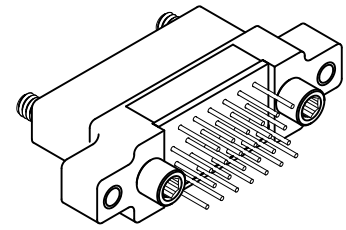

9 POSITION

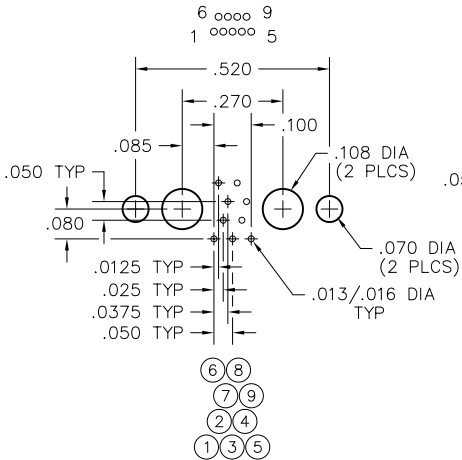

15 POSITION

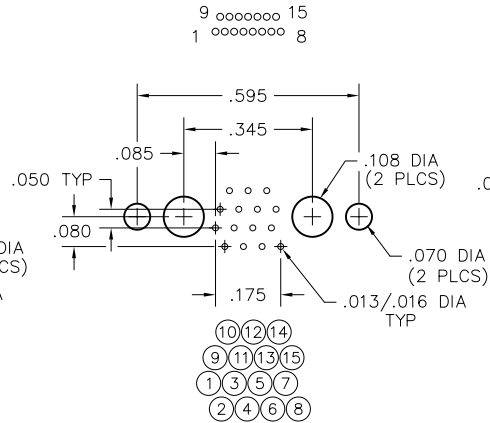

21 POSITION

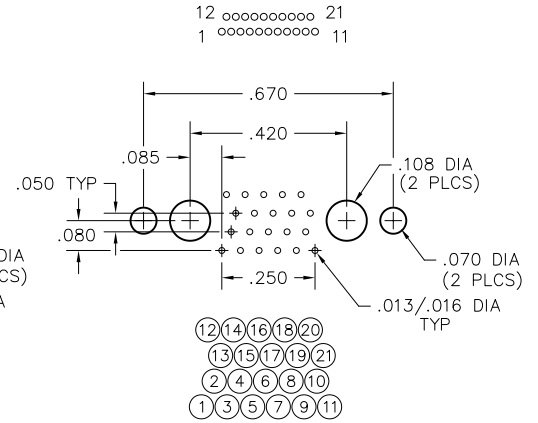

25 POSITION

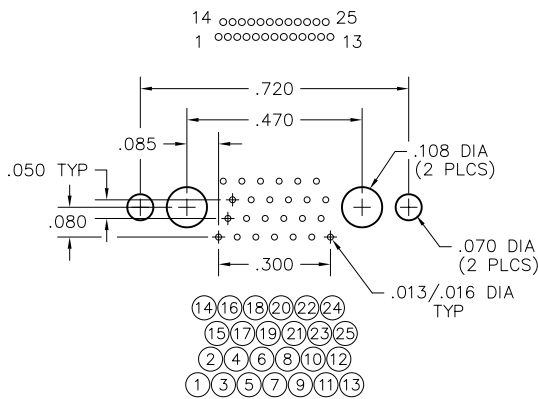

31 POSITION

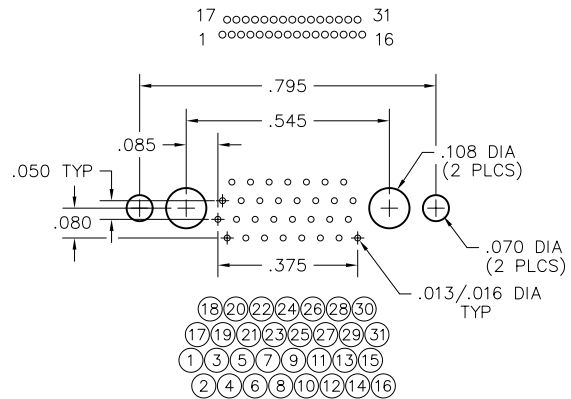

37 POSITION

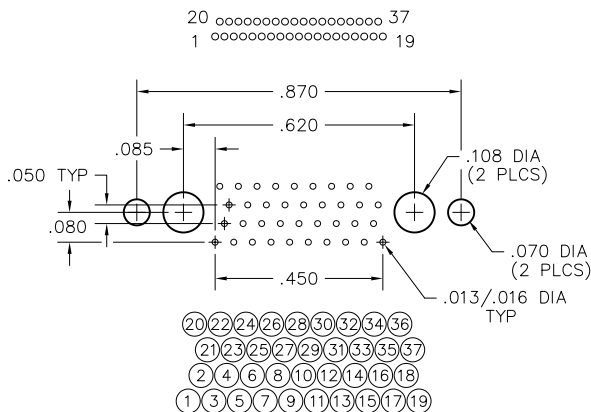

51 POSITION

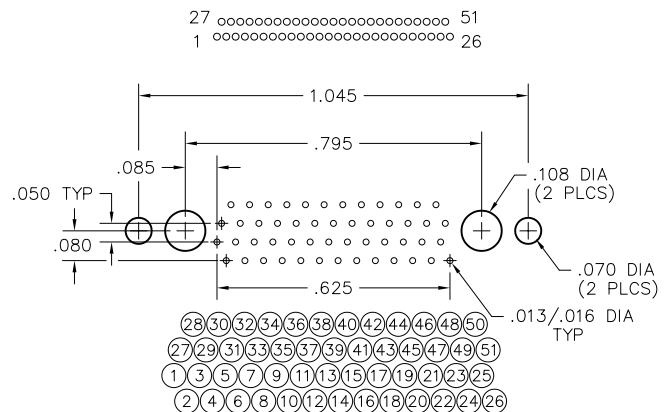

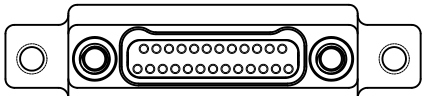

CONNECTOR MATING FACE

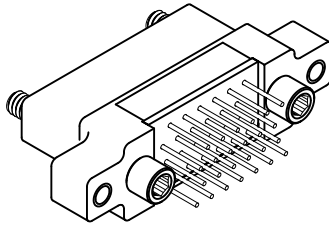

Recommended PC Board Layout

Vertical PTH Receptacle with turning hardware and mounting ears
FOR REFERENCE ONLY

65 POSITION

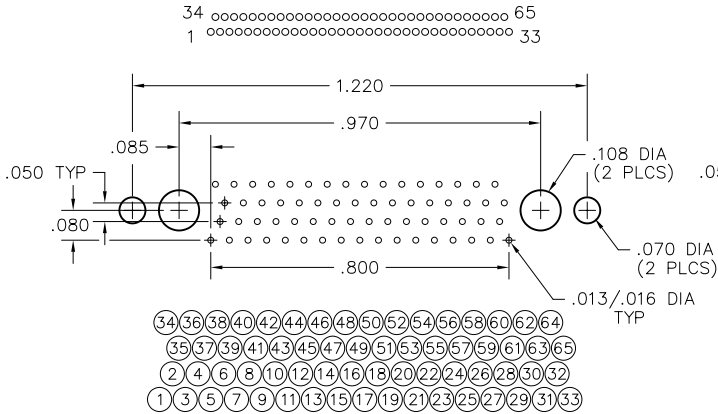

69 POSITION

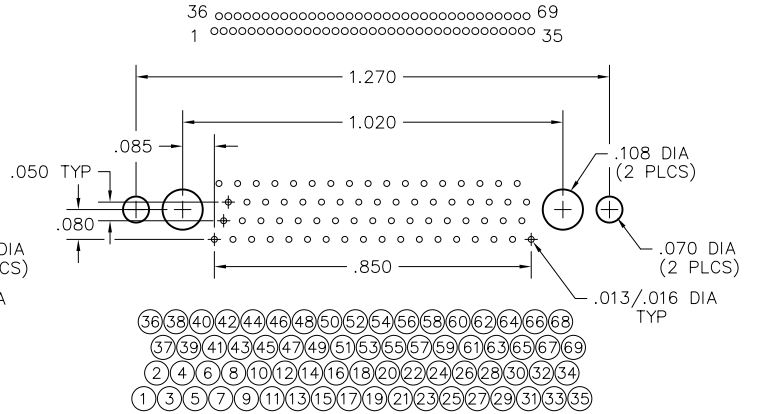

85 POSITION

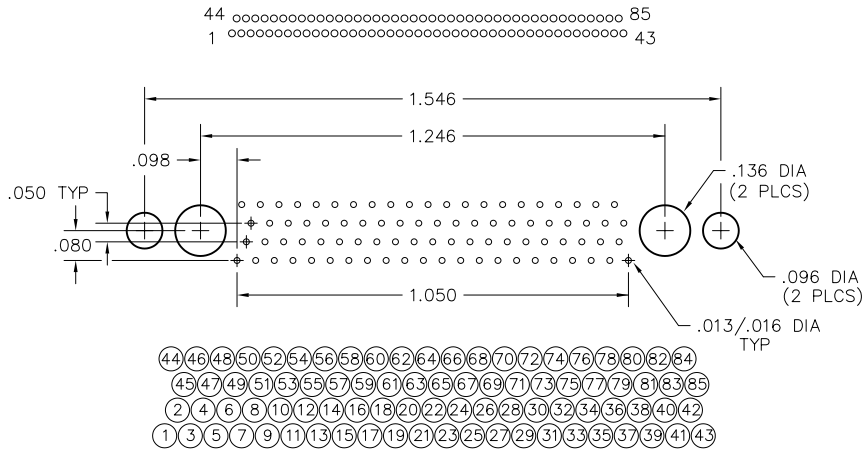

2 · ROW FLEX TO BOARD

.025"

NM, NK

9 thru 85 Contacts

NK-2D2-025-225-TH00
(METAL)

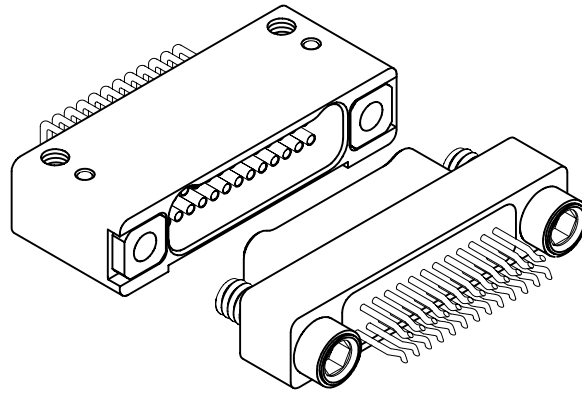

NM-212-025-125-JC00
(METAL)

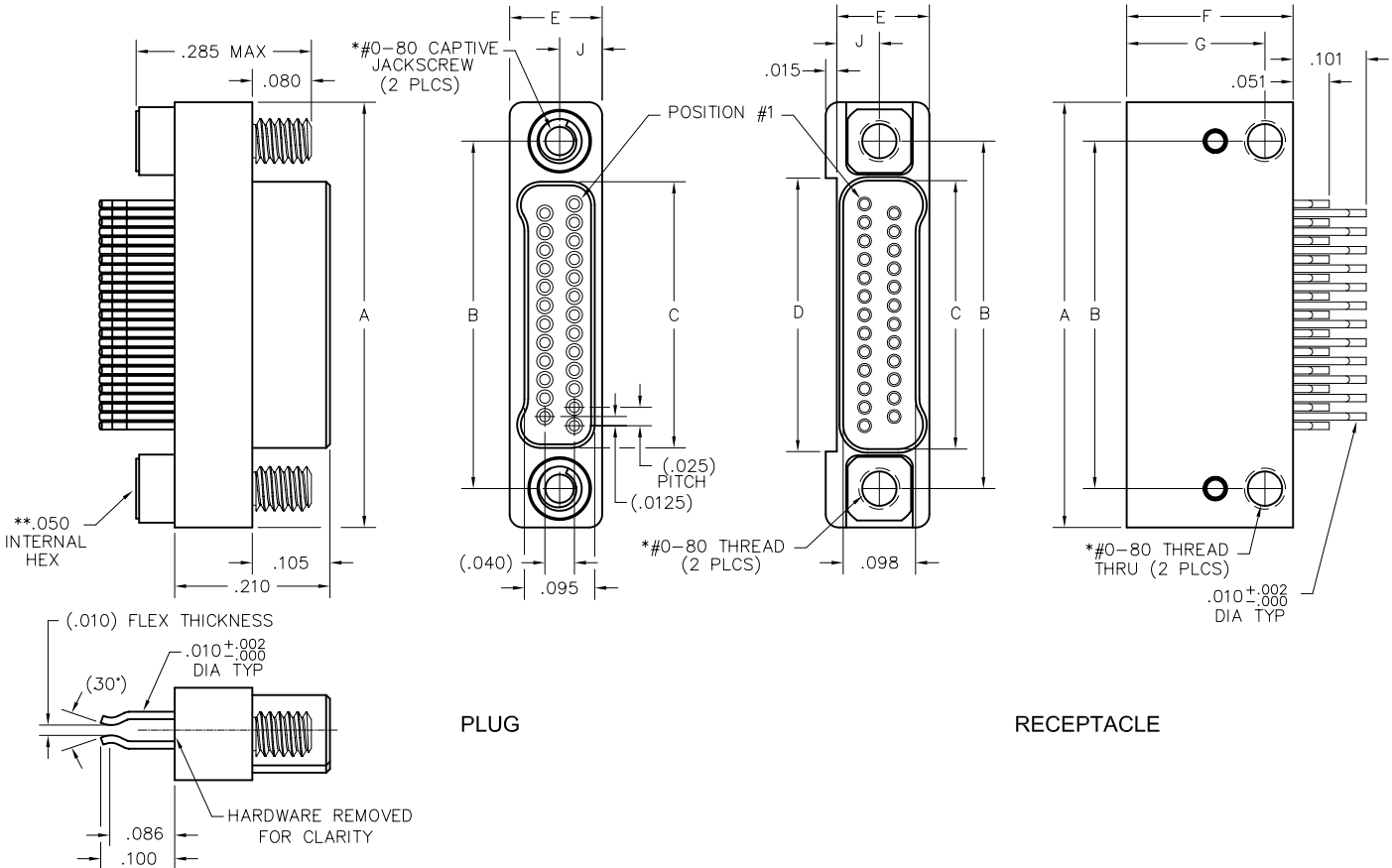

PLUG

RECEPTACLE

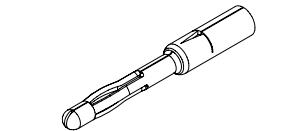

PIN CONTACT
3 TINE SPRING MEMBER, CRIMP

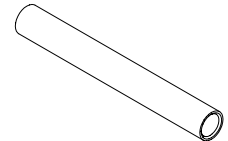

SOCKET CONTACT
DRAWN TUBE, CRIMP

SIZE	A	B	C		D	E	F	G	J	*HARDWARE
			PLUG	RCPT						
9	.375	.270	.160	.163	.170					
15	.450	.345	.235	.238	.245					
21	.525	.420	.310	.313	.320					
25	.575	.470	.360	.363	.370					
31	.650	.545	.435	.438	.445	.125	.225	.187	.0575	#0-80 THREAD
37	.725	.620	.510	.513	.520					
51	.900	.795	.685	.688	.695					
65	1.075	.970	.860	.863	.870					
69	1.125	1.020	.910	.913	.920					
85	1.377	1.246	1.110	1.113	1.120	.150	.270	.210	.0700	#2-56 THREAD

* = #2-56 UNC THREAD ON 85 POSITION CONNECTORS.
** = 1/16" HEX ON 85 POSITION CONNECTORS. HEX MEASUREMENTS
TAKEN ACROSS THE FLATS.

PLUG: NM-212-025-125-JC00
RECEPTACLE: NK-2D2-025-225-TH00
 XX-XXX-XXX-XXX-XXXX

PLUG	RECEPTACLE
SERIES	

NM .025" Metal Straddle Mount Flex Connector	NK .025" Metal PC Board Mounted Connector
--	---

BODY	
-------------	--

2 2-Row	2 2-Row
BODY STYLE: 1 Plug, straight	BODY STYLE: D Receptacle, horizontal mount SMT
BODY MATERIAL: 2 Liquid Crystal Polymer w/ electroless nickel shell 3 Liquid Crystal Polymer w/ electrodeposited cadmium shell <input checked="" type="checkbox"/>	BODY MATERIAL: 2 Liquid Crystal Polymer w/ electroless nickel shell 3 Liquid Crystal Polymer w/ electrodeposited cadmium shell <input checked="" type="checkbox"/>

SIZE	
-------------	--

XXX Number of contacts (009, 015, 021, 025, 031, 037, 051, 065, 069 or 085)	XXX Number of contacts (009, 015, 021, 025, 031, 037, 051, 065, 069 or 085)
---	---

CONTACTS	
-----------------	--

TYPE CONTACTS/TERMINATIONS: 12 Pin, straddle SMT	TYPE CONTACTS/TERMINATIONS: 22 Socket, SMT
PLATING OPTIONS: 5 50 u" Au contacts; Sn/Pb alloy terminations <input checked="" type="checkbox"/> 8 50 u" Au contacts; Tin plated terminations	PLATING OPTIONS: 5 50 u" Au contacts; Sn/Pb alloy terminations <input checked="" type="checkbox"/> 8 50 u" Au contacts; Tin plated terminations

HARDWARE	
-----------------	--

STYLE OF HARDWARE: 00 None JC Turning jackscrews, captivated #0-80 UNF*	STYLE OF HARDWARE: 00 None TH Threaded hole, #0-80 UNF*
WIRING OPTIONS: 00 None	WIRING OPTIONS: 00 None

* = #2-56 UNC thread on 85 position connectors
 .050 hex key (#0-80 thread)
 1/16" hex key (#2-56 thread)
 Recommended torque value 1.0 inch-lbs. max. (#0-80 thread)
 Recommended torque value 2.0 inch-lbs. max. (#2-56 thread)
 Ball end hex wrench not recommended
 Hex wrench key/bit conforming to the requirements of ASME / ANSI-B-18.3 is recommended.
 .050" hex L-key long arm wrench - order AirBorn p/n CDG14148.
 1/16" hex L-key long arm wrench - order AirBorn p/n CDG14160.

= Option not RoHS compliant

2 · ROW FLEX TO BOARD

.025"

NM, NK

9 thru 85 Contacts

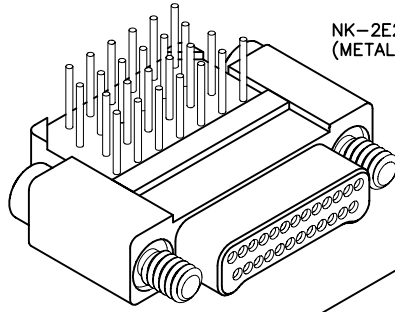

NK-2E2-025-325-JC00
(METAL)

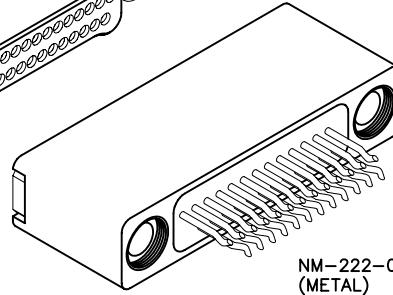

NM-222-025-225-TH00
(METAL)

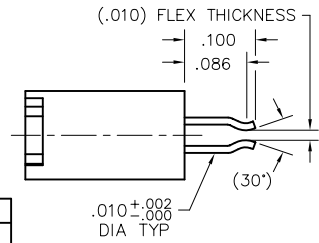
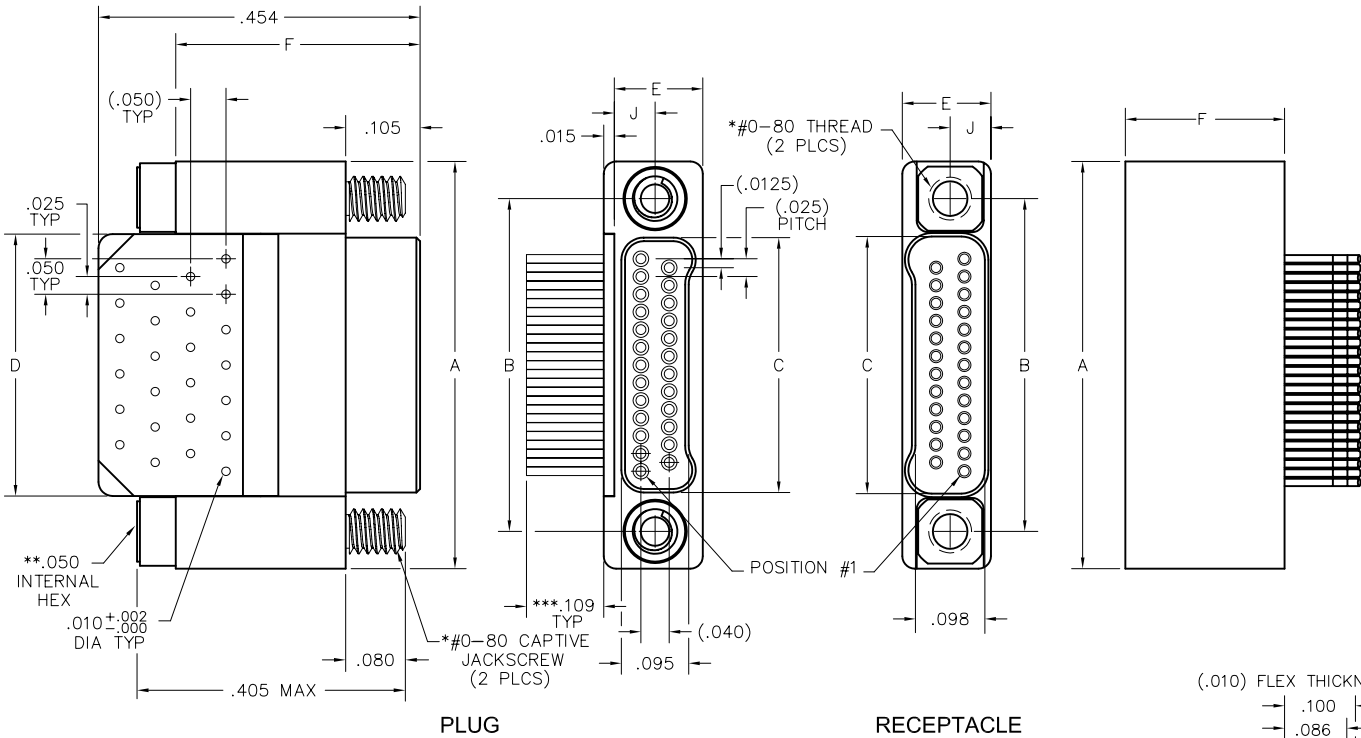

SIZE	A	B	C		D	E	F		J	*HARDWARE
			PLUG	RCPT			PLUG	RCPT		
9	.375	.270	.160	.163	.170	.125	.330	.225	.0575	#0-80 THREAD
15	.450	.345	.235	.238	.245					
21	.525	.420	.310	.313	.320					
25	.575	.470	.360	.363	.370					
31	.650	.545	.435	.438	.445					
37	.725	.620	.510	.513	.520					
51	.900	.795	.685	.688	.695					
65	1.075	.970	.860	.863	.870					
69	1.125	1.020	.910	.913	.920					
85	1.377	1.246	1.110	1.113	1.120					

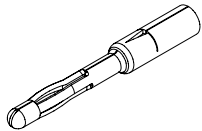

PIN CONTACT
3 TINE SPRING MEMBER, CRIMP

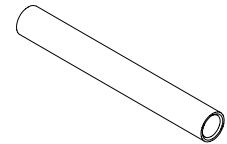

SOCKET CONTACT
DRAWN TUBE, CRIMP

* = #2-56 UNC THREAD ON 85 POSITION CONNECTORS.
 ** = 1/16" HEX ON 85 POSITION CONNECTORS. HEX MEASUREMENT TAKEN ACROSS THE FLATS.
 *** = OTHER LENGTHS AS REQUIRED

PLUG: NK-2E2-025-325-JC00
RECEPTACLE: NM-222-025-225-TH00
 XX-XXX-XXX-XXX-XXXX

PLUG

RECEPTACLE

SERIES

NK .025" Metal PC Board Mounted Connector | NM .025" Metal Straddle Mount Flex Connector

BODY

2	2-Row	2	2-Row
BODY STYLE:		BODY STYLE:	
E	Plug, right angle, plated thru hole (PTH)	2	Receptacle, straight
BODY MATERIAL:		BODY MATERIAL:	
2	Liquid Crystal Polymer w/ electroless nickel shell	2	Liquid Crystal Polymer w/ electroless nickel shell
3	Liquid Crystal Polymer w/ electrodeposited cadmium shell <input checked="" type="checkbox"/>	3	Liquid Crystal Polymer w/ electrodeposited cadmium shell <input checked="" type="checkbox"/>

SIZE

XXX Number of contacts (009, 015, 021, 025, 031, 037, 051, 065, 069 or 085) | XXX Number of contacts (009, 015, 021, 025, 031, 037, 051, 065, 069 or 085)

CONTACTS

TYPE CONTACTS/TERMINATIONS:		TYPE CONTACTS/TERMINATIONS:	
32	Pin, right angle, .109"	22	Socket, straddle SMT
33	Pin, right angle, .140"		
34	Pin, right angle, .172"		
PLATING OPTIONS:		PLATING OPTIONS:	
5	50 u" Au contacts; Sn/Pb alloy terminations <input checked="" type="checkbox"/>	5	50 u" Au contacts; Sn/Pb alloy terminations <input checked="" type="checkbox"/>
8	50 u" Au contacts; Tin plated terminations	8	50 u" Au contacts; Tin plated terminations

HARDWARE

STYLE OF HARDWARE:		STYLE OF HARDWARE:	
00	None	00	None
JC	Turning jackscrews, captive #0-80 UNF*	TH	Threaded hole, #0-80 UNF*
WIRING OPTIONS:		WIRING OPTIONS:	
00	None	00	None

* = #2-56 UNC thread on 85 position connectors
 .050 hex key (#0-80 thread)
 1/16" hex key (#2-56 thread)
 Recommended torque value 1.0 inch-lbs. max. (#0-80 thread)
 Recommended torque value 2.0 inch-lbs. max. (#2-56 thread)
 Ball end hex wrench not recommended
 Hex wrench key/bit conforming to the requirements of ASME / ANSI-B-18.3 is recommended.
 .050" hex L-key long arm wrench - order AirBorn p/n CDG14148.
 1/16" hex L-key long arm wrench - order AirBorn p/n CDG14160.

= Option not RoHS compliant



Recommended Flex Circuit Layout

Straddle Mount Flex Plug
FOR REFERENCE ONLY

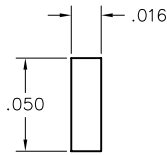

FOOTPRINT / PAD
CONFIGURATION

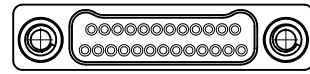
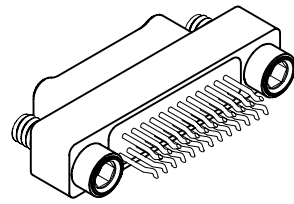

CONNECTOR MATING FACE

9 POSITION

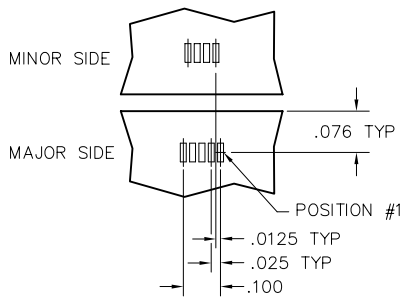

15 POSITION

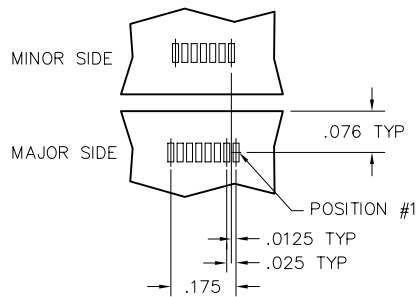
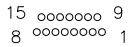

21 POSITION

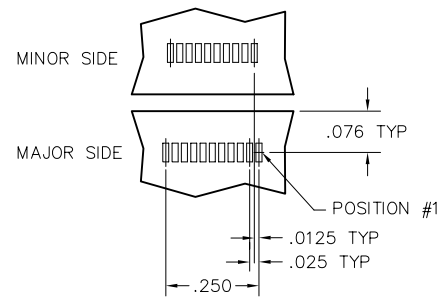
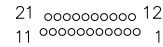

25 POSITION

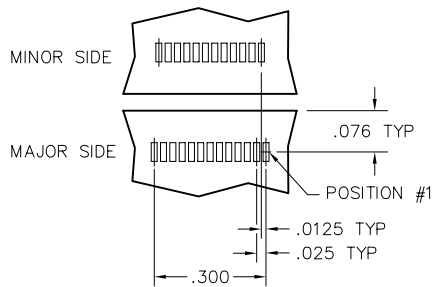
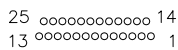

31 POSITION

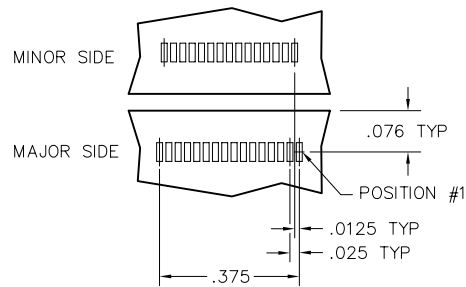
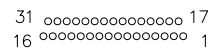

37 POSITION

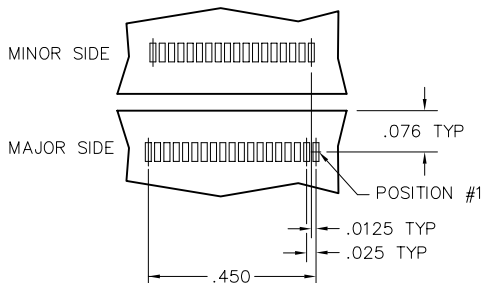
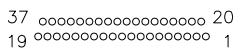

51 POSITION

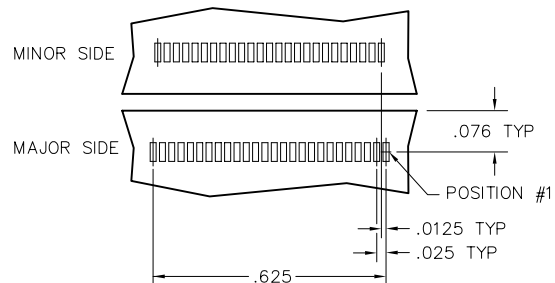
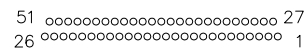

Recommended Flex Circuit Layout

Straddle Mount Flex Plug
FOR REFERENCE ONLY

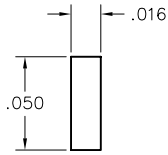

FOOTPRINT / PAD
CONFIGURATION

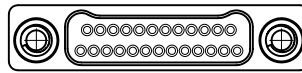
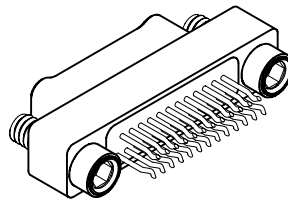

CONNECTOR MATING FACE

65 POSITION

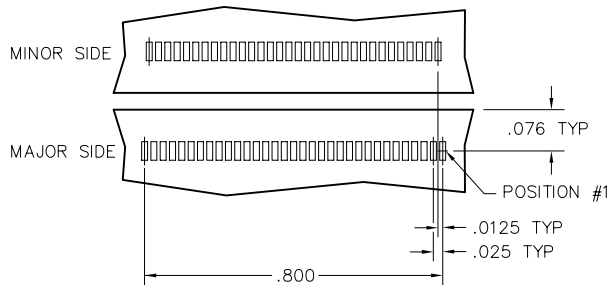
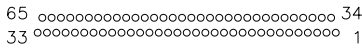

69 POSITION

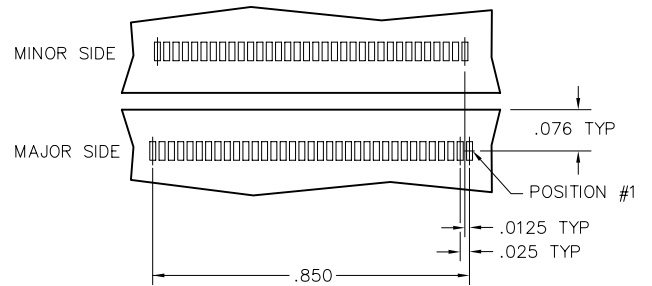
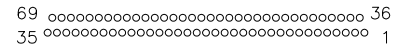

85 POSITION

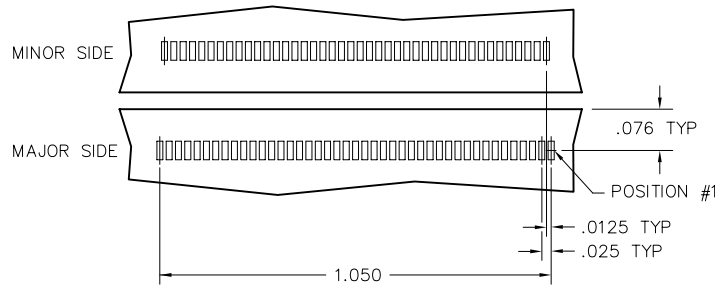
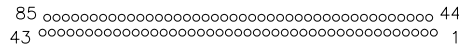



Recommended Flex Circuit Layout

Straddle Mount Flex Receptacle
FOR REFERENCE ONLY

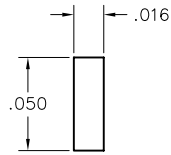

FOOTPRINT / PAD
CONFIGURATION

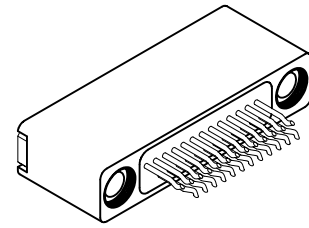

CONNECTOR MATING FACE

9 POSITION

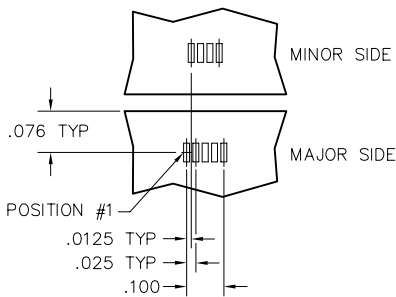

15 POSITION

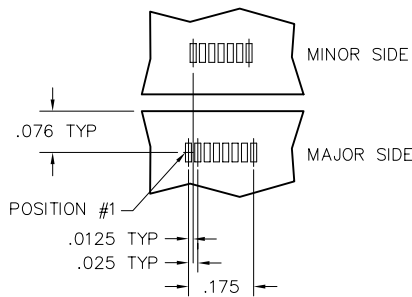
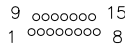

21 POSITION

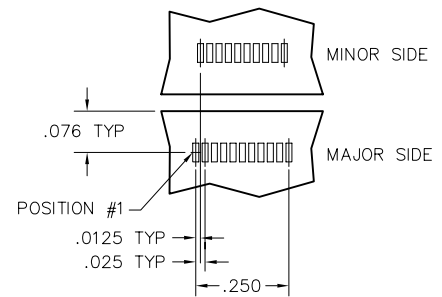
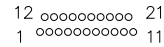

25 POSITION

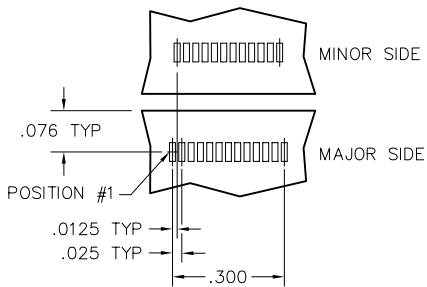
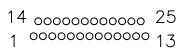

31 POSITION

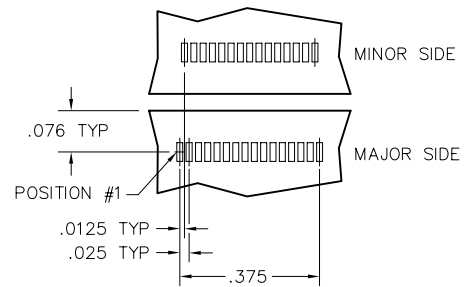
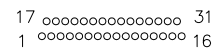

37 POSITION

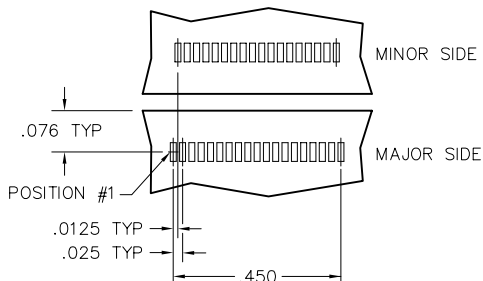
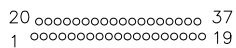

51 POSITION

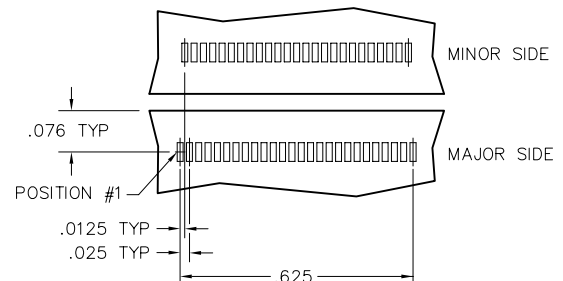
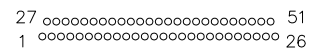



Recommended Flex Circuit Layout

Straddle Mount Flex Receptacle
FOR REFERENCE ONLY

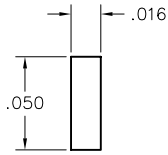

FOOTPRINT / PAD
CONFIGURATION

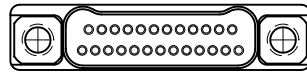
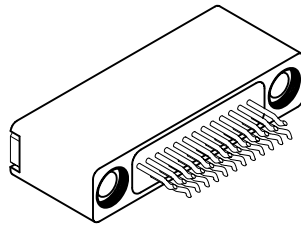

CONNECTOR MATING FACE

65 POSITION

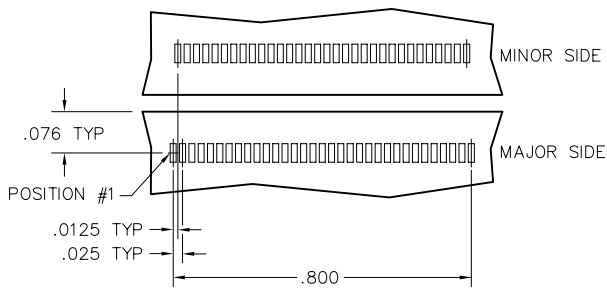
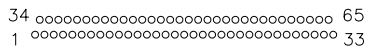

69 POSITION

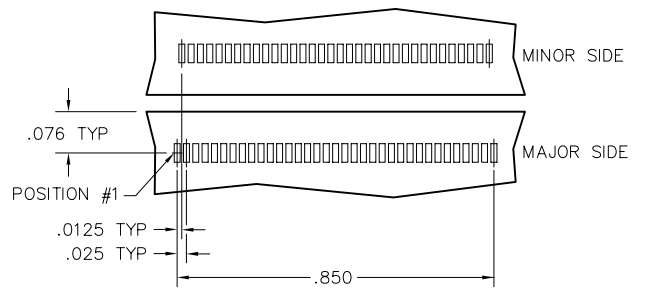
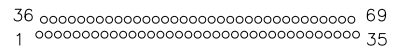

85 POSITION

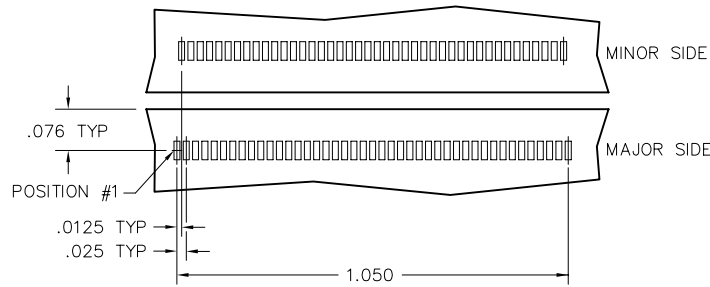
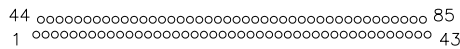



2 · ROW Flex to Board

.025"

NK, NK

9 thru 85 Contacts

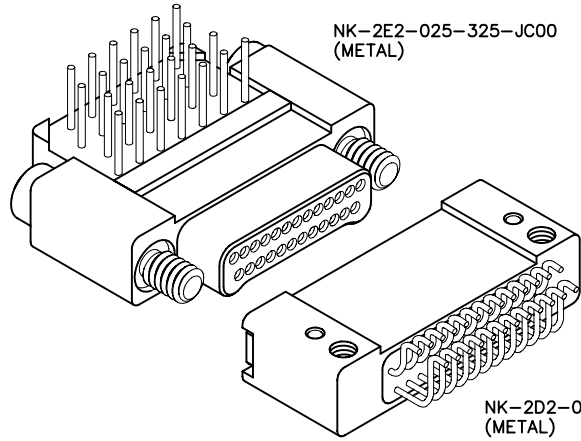

NK-2E2-025-325-JC00
(METAL)

NK-2D2-025-225-TH00
(METAL)

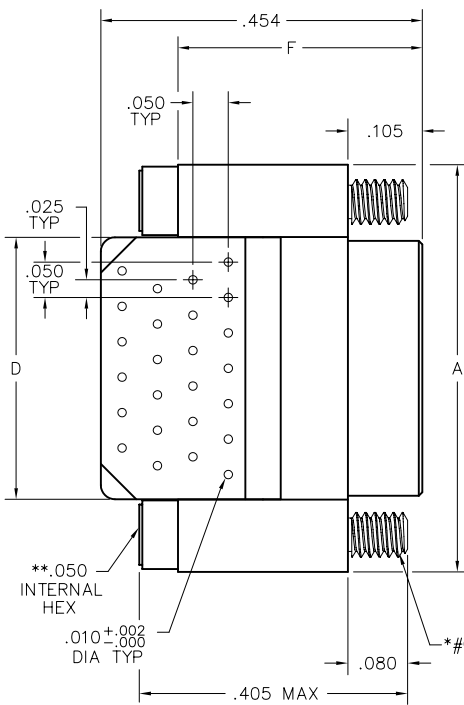

PLUG

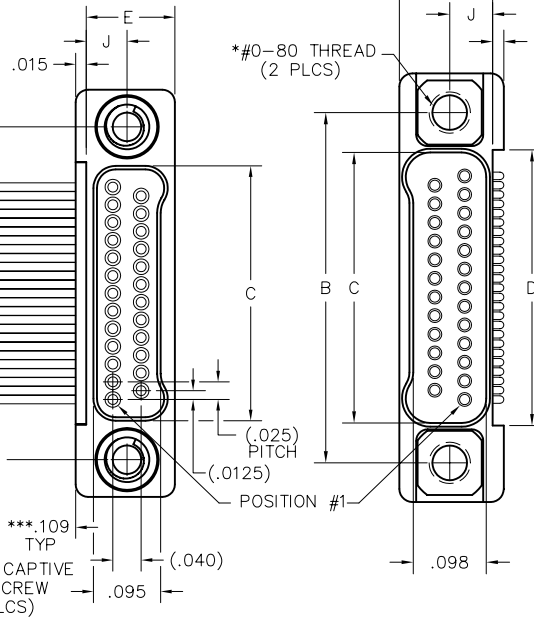

RECEPTACLE

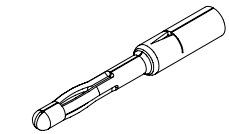
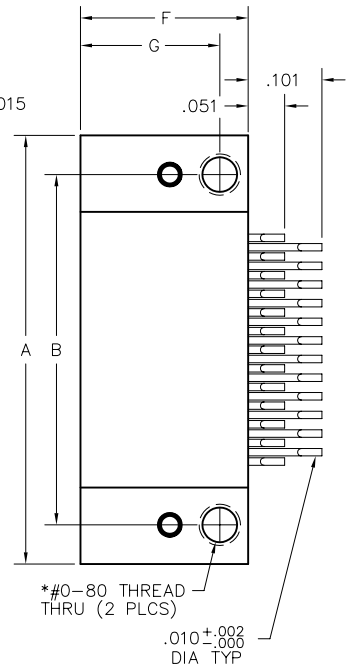

PIN CONTACT
3 TINE SPRING MEMBER,
CRIMP

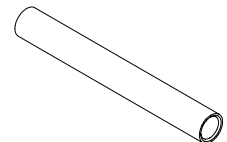

SOCKET CONTACT
DRAWN TUBE, CRIMP

SIZE	DIMENSIONS										
	A	B	C		D	E	F		G	J	*HARDWARE
			PLUG	RCPT			PLUG	RCPT			
9	.375	.270	.160	.163	.170						
15	.450	.345	.235	.238	.245						
21	.525	.420	.310	.313	.320						
25	.575	.470	.360	.363	.370						
31	.650	.545	.435	.438	.445	.125	.330	.225	.187	.0575	#0-80 THREAD
37	.725	.620	.510	.513	.520						
51	.900	.795	.685	.688	.695						
65	1.075	.970	.860	.863	.870						
69	1.125	1.020	.910	.913	.920						
85	1.377	1.246	1.110	1.113	1.120	.150		.270	.210	.0700	#2-56 THREAD

* = #2-56 UNC THREAD ON 85 POSITION CONNECTORS.
 ** = 1/16" HEX ON 85 POSITION CONNECTORS. HEX MEASUREMENT
 TAKEN ACROSS THE FLATS.
 *** = OTHER LENGTHS AS REQUIRED

PLUG: NK-2E2-025-325-JC00
RECEPTACLE: NK-2D2-025-225-TH00
 XX-XXX-XXX-XXX-XXXX

PLUG

RECEPTACLE

SERIES

NK .025" Metal PC Board Mounted Connector | NK .025" Metal PC Board Mounted Connector

BODY

2	2-Row	2	2-Row
BODY STYLE:		BODY STYLE:	
E	Plug, right angle, plated thru hole (PTH)	D	Receptacle, horizontal mount SMT
BODY MATERIAL:		BODY MATERIAL:	
2	Liquid Crystal Polymer w/ electroless nickel shell	2	Liquid Crystal Polymer w/ electroless nickel shell
3	Liquid Crystal Polymer w/ electrodeposited cadmium shell <input checked="" type="checkbox"/>	3	Liquid Crystal Polymer w/ electrodeposited cadmium shell <input checked="" type="checkbox"/>

SIZE

XXX Number of contacts (009, 015, 021, 025, 031, 037, 051, 065, 069 or 085) | XXX Number of contacts (009, 015, 021, 025, 031, 037, 051, 065, 069 or 085)

CONTACTS

TYPE CONTACTS/TERMINATIONS:		TYPE CONTACTS/TERMINATIONS:	
32	Pin, right angle, .109"	22	Socket, SMT
33	Pin, right angle, .140"		
34	Pin, right angle, .172"		
PLATING OPTIONS:		PLATING OPTIONS:	
5	50 u" Au contacts; Sn/Pb alloy terminations <input checked="" type="checkbox"/>	5	50 u" Au contacts; Sn/Pb alloy terminations <input checked="" type="checkbox"/>
8	50 u" Au contacts; Tin plated terminations	8	50 u" Au contacts; Tin plated terminations

HARDWARE

STYLE OF HARDWARE:		STYLE OF HARDWARE:	
00	None	00	None
JC	Turning jackscrews, captivated #0-80 UNF*	TH	Threaded hole, #0-80 UNF*
WIRING OPTIONS:		WIRING OPTIONS:	
00	None	00	None

* = #2-56 UNC thread on 85 position connectors
 .050 hex key (#0-80 thread)
 1/16" hex key (#2-56 thread)
 Recommended torque value 1.0 inch-lbs. max. (#0-80 thread)
 Recommended torque value 2.0 inch-lbs. max. (#2-56 thread)
 Ball end hex wrench not recommended
 Hex wrench key/bit conforming to the requirements of ASME / ANSI-B-18.3 is recommended.
 .050" hex L-key long arm wrench - order AirBorn p/n CDG14148.
 1/16" hex L-key long arm wrench - order AirBorn p/n CDG14160.

= Option not RoHS compliant



Recommended Flex Circuit Layout

Right Angle Flex Mount PTH Plug
FOR REFERENCE ONLY

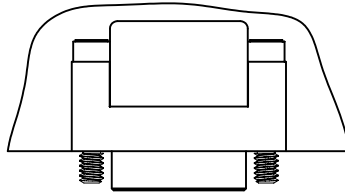

FLEX CIRCUIT LAYOUT
COMPONENT SIDE

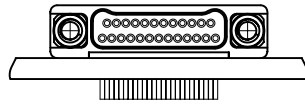

CONNECTOR MATING FACE

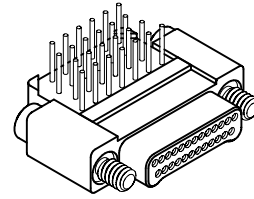

9 POSITION

9 ○○○○ 6
5 ○○○○ 1

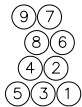
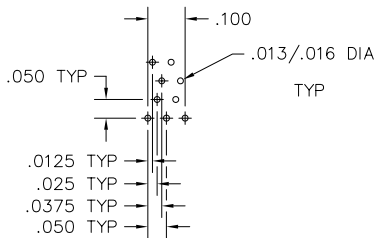

15 POSITION

15 ○○○○○○ 9
8 ○○○○○○ 1

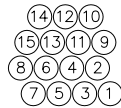
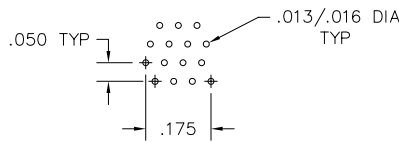

21 POSITION

21 ○○○○○○○○ 12
11 ○○○○○○○○ 1

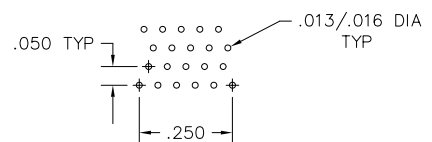

25 POSITION

25 ○○○○○○○○○○ 14
13 ○○○○○○○○○○ 1

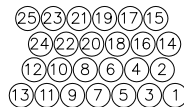
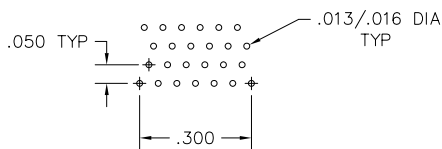

31 POSITION

31 ○○○○○○○○○○○○ 17
16 ○○○○○○○○○○○○ 1

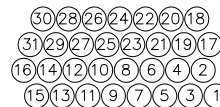
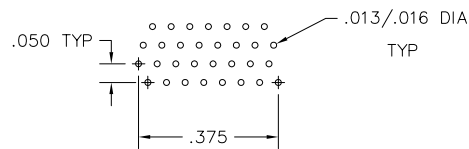

37 POSITION

37 ○○○○○○○○○○○○○○ 20
19 ○○○○○○○○○○○○○○ 1

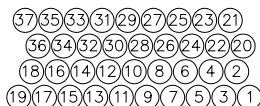
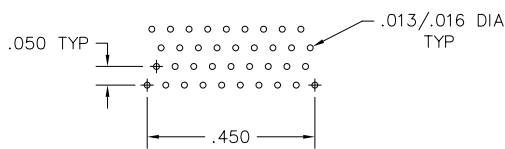

51 POSITION

51 ○○○○○○○○○○○○○○○○○○○○○○ 27
26 ○○○○○○○○○○○○○○○○○○○○○○ 1

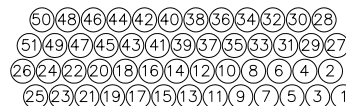
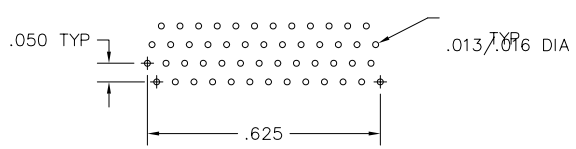

Recommended Flex Circuit Layout

Right Angle Flex Mount PTH Plug
FOR REFERENCE ONLY

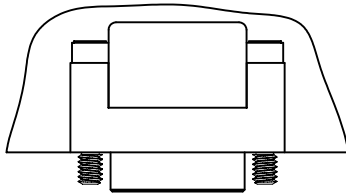

FLEX CIRCUIT LAYOUT
COMPONENT SIDE

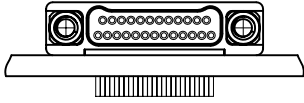
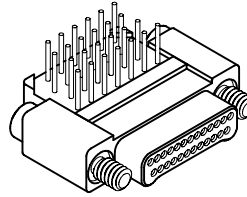

CONNECTOR MATING FACE

65 POSITION

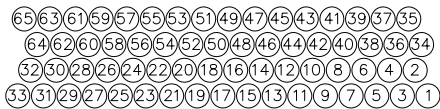
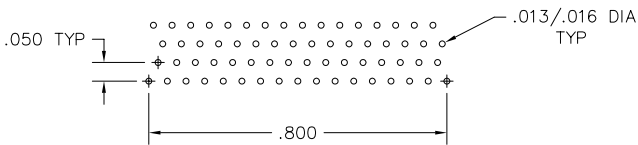
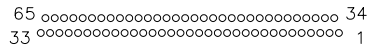

69 POSITION

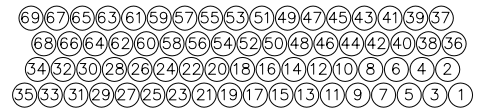
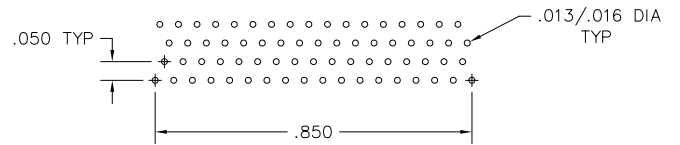
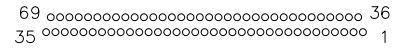

85 POSITION

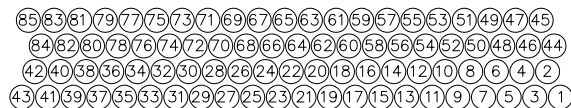
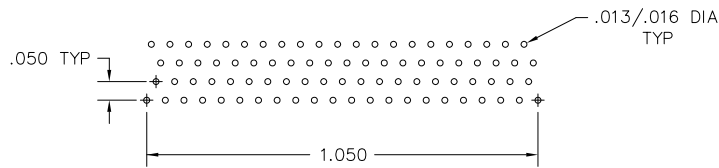
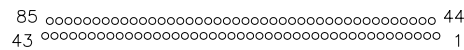



2 · ROW Horizontal SMT with Jackscrews Plug .025"

NK

9 thru 85 Contacts

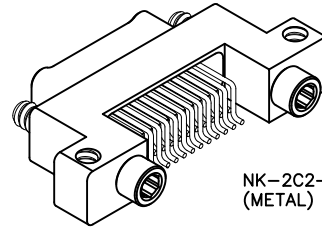

NK-2C2-025-125-JC00
(METAL)

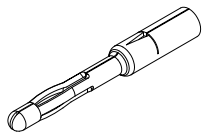
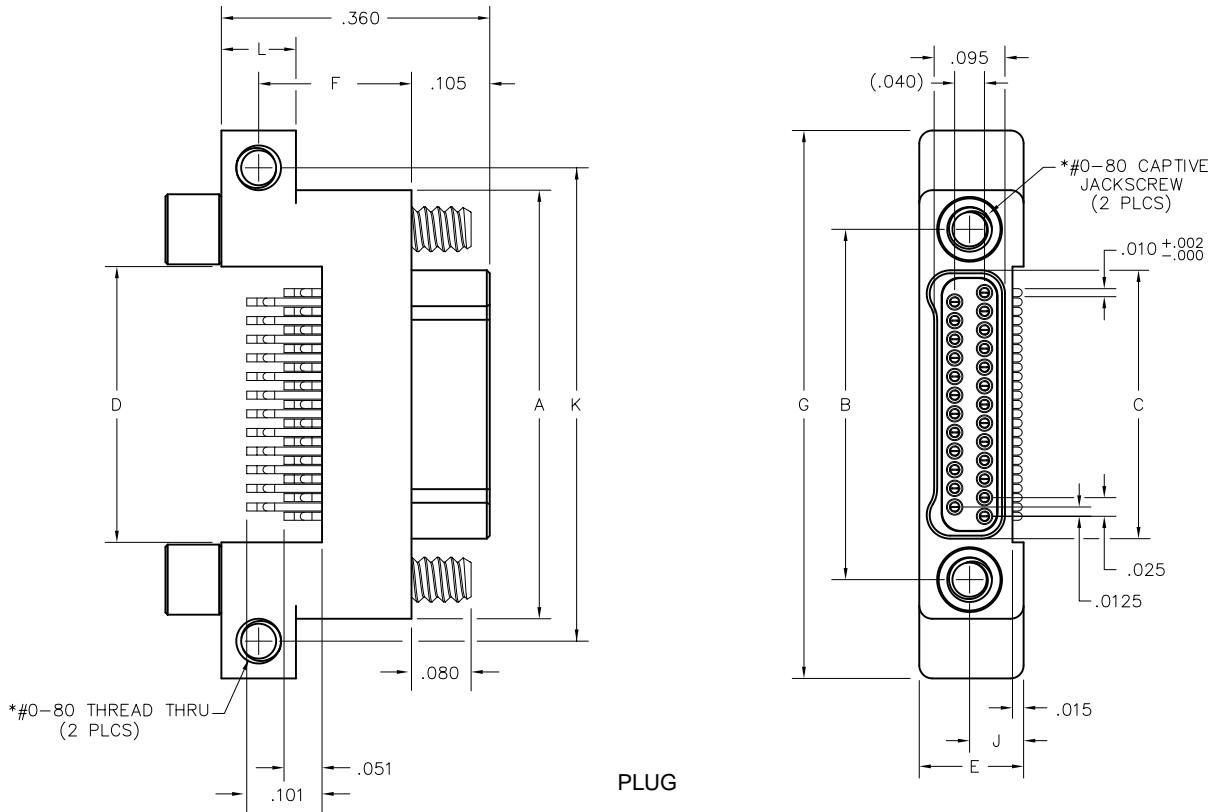

PIN CONTACT
3 TINE SPRING MEMBER, CRIMP

DIMENSIONS											
SIZE	A	B	C	D	E	F	G	J	K	L	*HARDWARE
9	.375	.270	.160	.170			.535		.435		#0-80 THREAD
15	.450	.345	.235	.245			.610		.510		
21	.525	.420	.310	.320			.685		.585		
25	.575	.470	.360	.370			.735		.635		
31	.650	.545	.435	.445	.125	.205	.810	.0575	.710	.100	
37	.725	.620	.510	.520			.885		.785		
51	.900	.795	.685	.695			1.060		.960		
65	1.075	.970	.860	.870			1.235		1.135		
69	1.125	1.020	.910	.920			1.285		1.185		
85	1.377	1.246	1.110	1.120	.150	.192	1.590	.0700	1.463	.126	

PLUG: NK-2C2-025-125-JC00
NK-XXX-XXX-XXX-XXXX

PLUG

SERIES

NK .025" Metal PC Board Mounted Connector

BODY

2 2-Row

BODY STYLE:

C Plug, horizontal mount SMT

BODY MATERIAL:

- 2 Liquid Crystal Polymer w/ electroless nickel shell
- 3 Liquid Crystal Polymer w/ electrodeposited cadmium shell

SIZE

XXX Number of contacts (009, 015, 021, 025, 031, 037, 051, 065, 069, or 085)

CONTACTS

TYPE CONTACTS/TERMINATIONS:

12 Pin, SMT

PLATING OPTIONS:

- 5 50 u" Au contacts, Sn/Pb alloy terminations
- 8 50 u" Au contacts, tin plated terminations

HARDWARE

STYLE OF HARDWARE:

JC Turning jackscrews, captivated #0-80 UNF*

WIRING OPTIONS:

00 None

* = #2-56 UNC thread on 85 position connectors
 .050 hex key (#0-80 thread)
 1/16" hex key (#2-56 thread)
 Recommended torque value 1.0 inch-lbs. max. (#0-80 thread)
 Recommended torque value 2.0 inch-lbs. max. (#2-56 thread)
 Ball end hex wrench not recommended
 Hex wrench key/bit conforming to the requirements of ASME / ANSI-B-18.3 is recommended.
 .050" hex L-key long arm wrench - order AirBorn p/n CDG14148.
 1/16" hex L-key long arm wrench - order AirBorn p/n CDG14160.

= Option not RoHS compliant



Recommended PC Board Layout

Horizontal SMT Plug
FOR REFERENCE ONLY

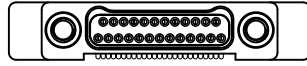
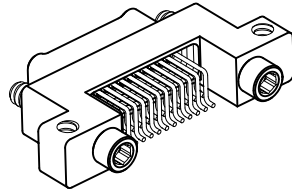

CONNECTOR MATING FACE

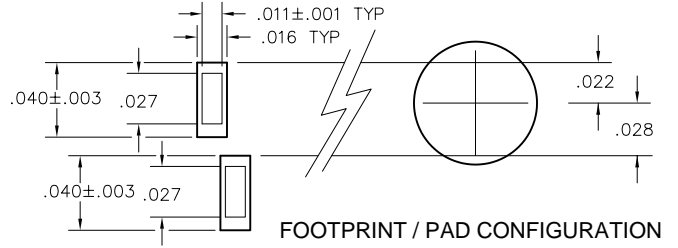

FOOTPRINT / PAD CONFIGURATION

9 POSITION

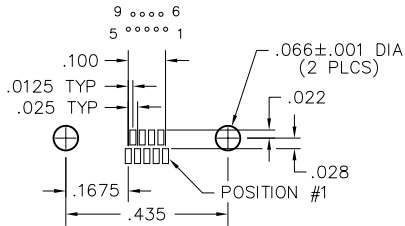

15 POSITION

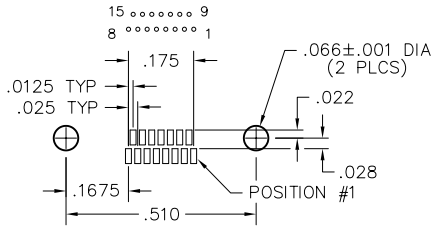

21 POSITION

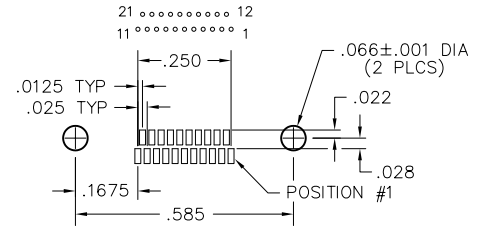

25 POSITION

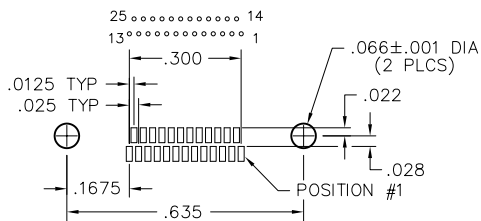

31 POSITION

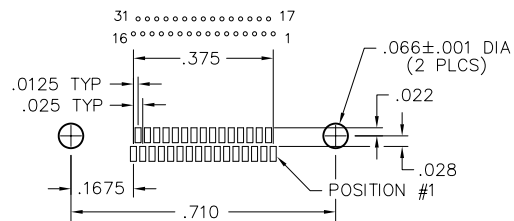

37 POSITION

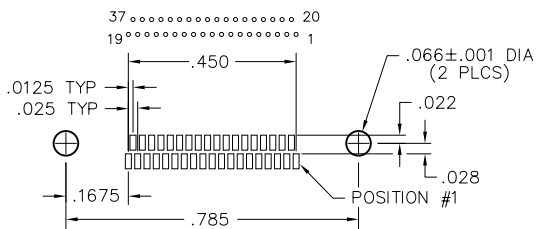

51 POSITION

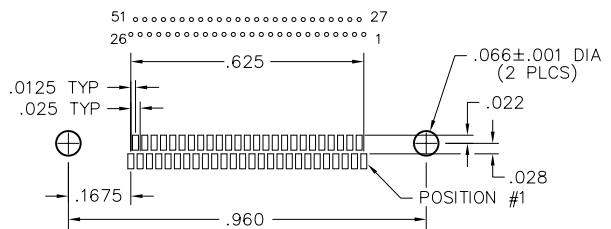

65 POSITION

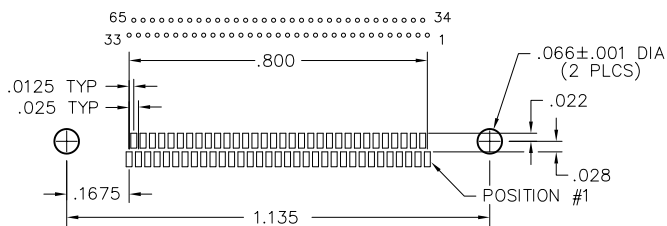

69 POSITION

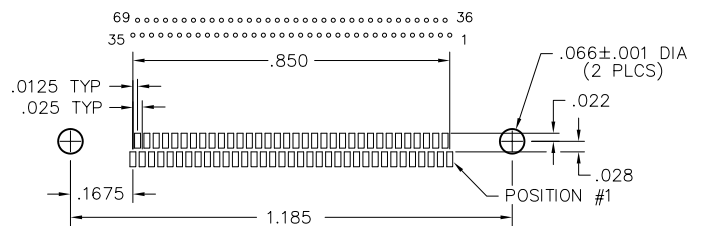

85 POSITION

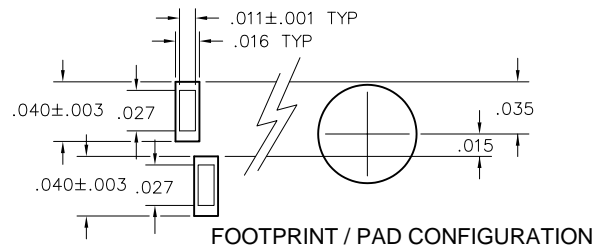
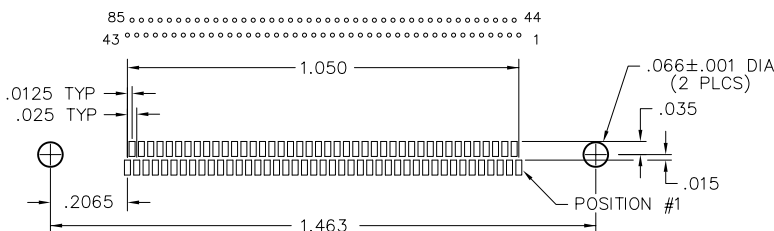

FOOTPRINT / PAD CONFIGURATION



2 · ROW
Splashproof**
Cable to Cable
.025"

NMSP, NMSP

9 thru 85 Contacts

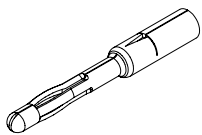
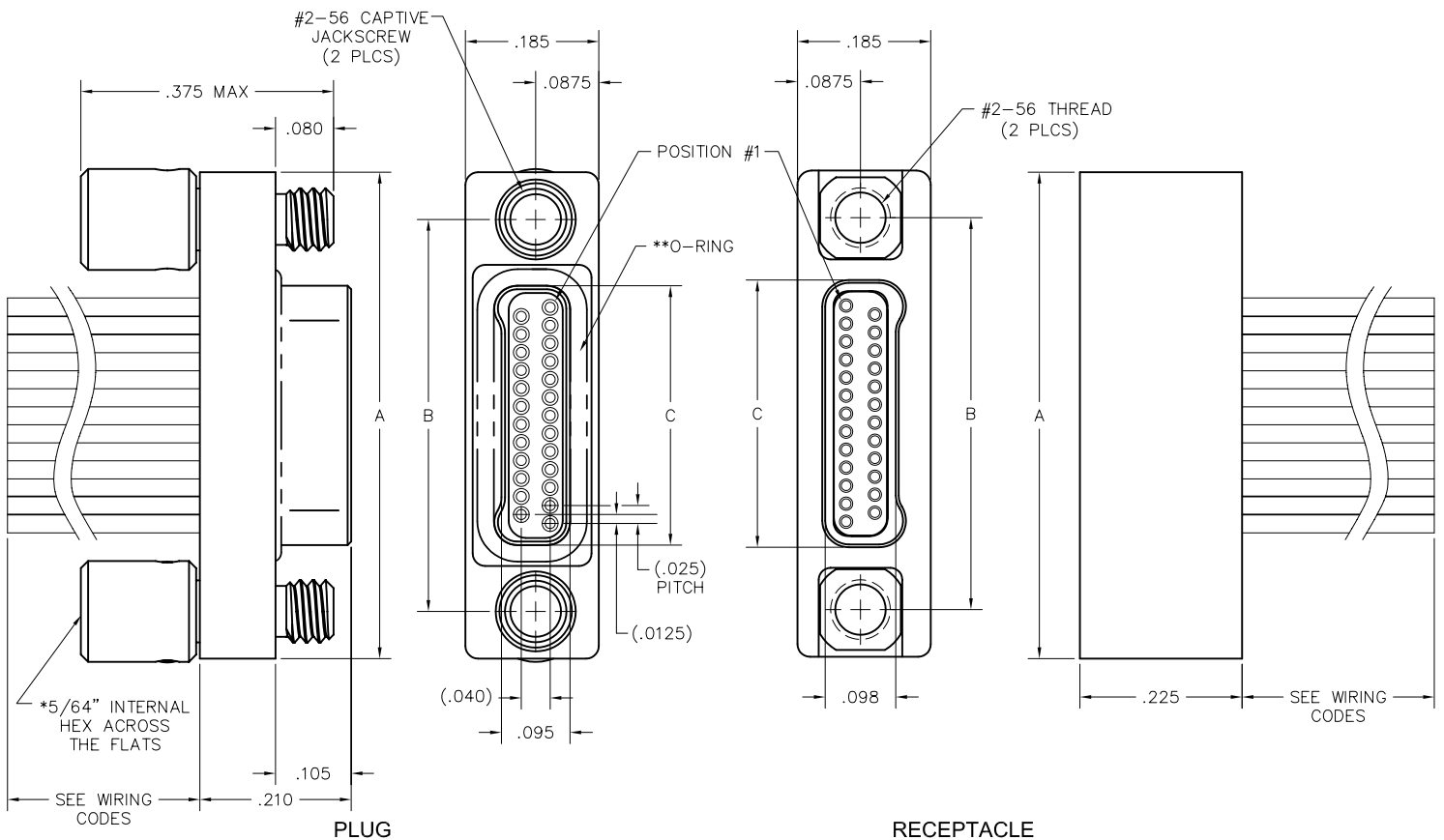
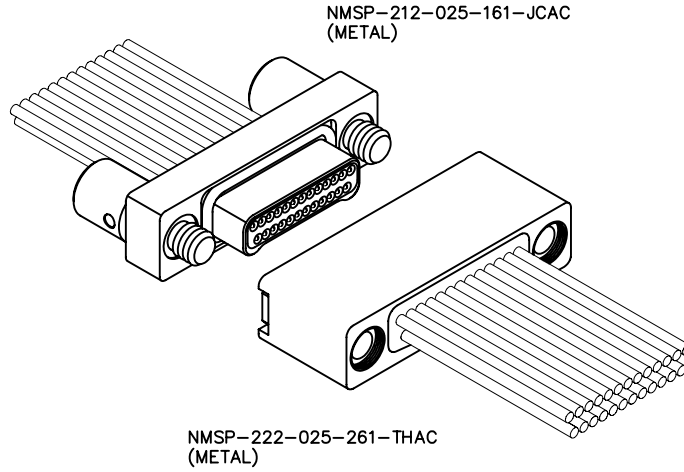

PIN CONTACT
3 TINE SPRING MEMBER, CRIMP

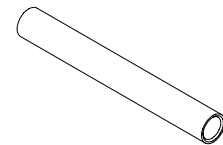

SOCKET CONTACT
DRAWN TUBE, CRIMP

SIZE	DIMENSIONS				HARDWARE
	A	B	C		
			PLUG	RCPT	
9	.475	.344	.160	.163	#2-56 THREAD
15	.550	.419	.235	.238	
21	.625	.494	.310	.313	
25	.675	.544	.360	.363	
31	.750	.619	.435	.438	
37	.825	.694	.510	.513	
51	1.000	.869	.685	.688	
65	1.175	1.044	.860	.863	
69	1.225	1.094	.910	.913	
85	1.425	1.294	1.110	1.113	

**The o-ring seal provides moisture resistance to fog, humidity and splashing.

PLUG: NMSP-212-025-161-JCAC
RECEPTACLE: NMSP-222-025-261-THAC
 XXXX-XXX-XXX-XXX-XXXX

PLUG		RECEPTACLE	
SERIES			
NMSP .025" Metal Splashproof I/O Connector		NMSP .025" Metal Splashproof I/O Connector	
BODY			
2	2-Row	2	2-Row
BODY STYLE:		BODY STYLE:	
1	Plug, straight, with fluorosilicone o-ring	2	Receptacle, straight
BODY MATERIAL:		BODY MATERIAL:	
2	Liquid Crystal Polymer w/ electroless nickel shell	2	Liquid Crystal Polymer w/ electroless nickel shell
3	Liquid Crystal Polymer w/ electrodeposited cadmium shell <input checked="" type="checkbox"/>	3	Liquid Crystal Polymer w/ electrodeposited cadmium shell <input checked="" type="checkbox"/>
SIZE			
XXX Number of contacts (009, 015, 021, 025, 031, 037, 051, 065, 069, or 085)		XXX Number of contacts (009, 015, 021, 025, 031, 037, 051, 065, 069, or 085)	
CONTACTS			
TYPE CONTACTS/TERMINATIONS:		TYPE CONTACTS/TERMINATIONS:	
16	Pin, straight, crimped wire	26	Socket, straight, crimped wire
PLATING OPTIONS:		PLATING OPTIONS:	
1	50 u" Au contacts	1	50 u" Au contacts
HARDWARE			
STYLE OF HARDWARE:		STYLE OF HARDWARE:	
JC	Turning jackscrews, captivated #2-56 UNF*	JC	Turning jackscrews, captivated #2-56 UNF*
TH	Threaded hole, #2-56 UNF	TH	Threaded hole, #2-56 UNF
WIRING OPTIONS:		WIRING OPTIONS:	
XX	See wiring codes, Page NA-2	XX	See wiring codes, Page NA-2

* 5/64" hex key
 Recommended torque value 2.0 inch-lbs. max.
 Ball end hex wrench not recommended
 Hex wrench key/bit conforming to the requirements of ASME / ANSI-B-18.3 is recommended.
 5/64" hex L-key long arm wrench - order AirBorn p/n CDG14179.

= Option not RoHS compliant

Performance - Rear Panel Mount Reference M32139

AirBorn "N" Series meets or exceeds M32139 Performance Specifications

Contact Rating:	1-ampere maximum
Solderability:	Terminals (except crimp) tested in accordance with MIL-STD-202, Method 208
Wire Size:	Stranded #30 & #32 AWG or solid #30 AWG standard (consult factory for other sizes and types)
Test Voltage:	250 V, RMS, 60 Hz
Operating Temperature:	-55° C to +125° C
Insulation Resistance:	5,000 megohms minimum @ 100 VDC
Durability:	200 connector mating cycles tested in accordance with EIA-364-09
Vibration:	Tested in accordance with EIA-364-28, Condition IV
Shock:	Tested in accordance with EIA-364-27, Condition G
Salt Spray:	Mated connectors tested in accordance with EIA-364-26, Condition B
Humidity:	Mated connectors tested in accordance with EIA-364-31, Condition A (except steps 7a and 7b)
Thermal Shock:	Tested to the temperature extremes of EIA-364-32, Condition I
Contact Resistance:	0.021 volt maximum drop @ 1.0 amps (.021 ohms)
Contact Engaging Force:	5.0 ounce maximum, with minimum diameter test sleeve
Contact Separating Force:	0.4 ounce minimum, with maximum diameter test sleeve
Crimp Strength:	1 pound minimum tensile strength

2 • ROW Rear Panel Mount I/O

.025"

NMRP

9 thru 85 Contacts

NMRP-224-025-261-TH00
(METAL)

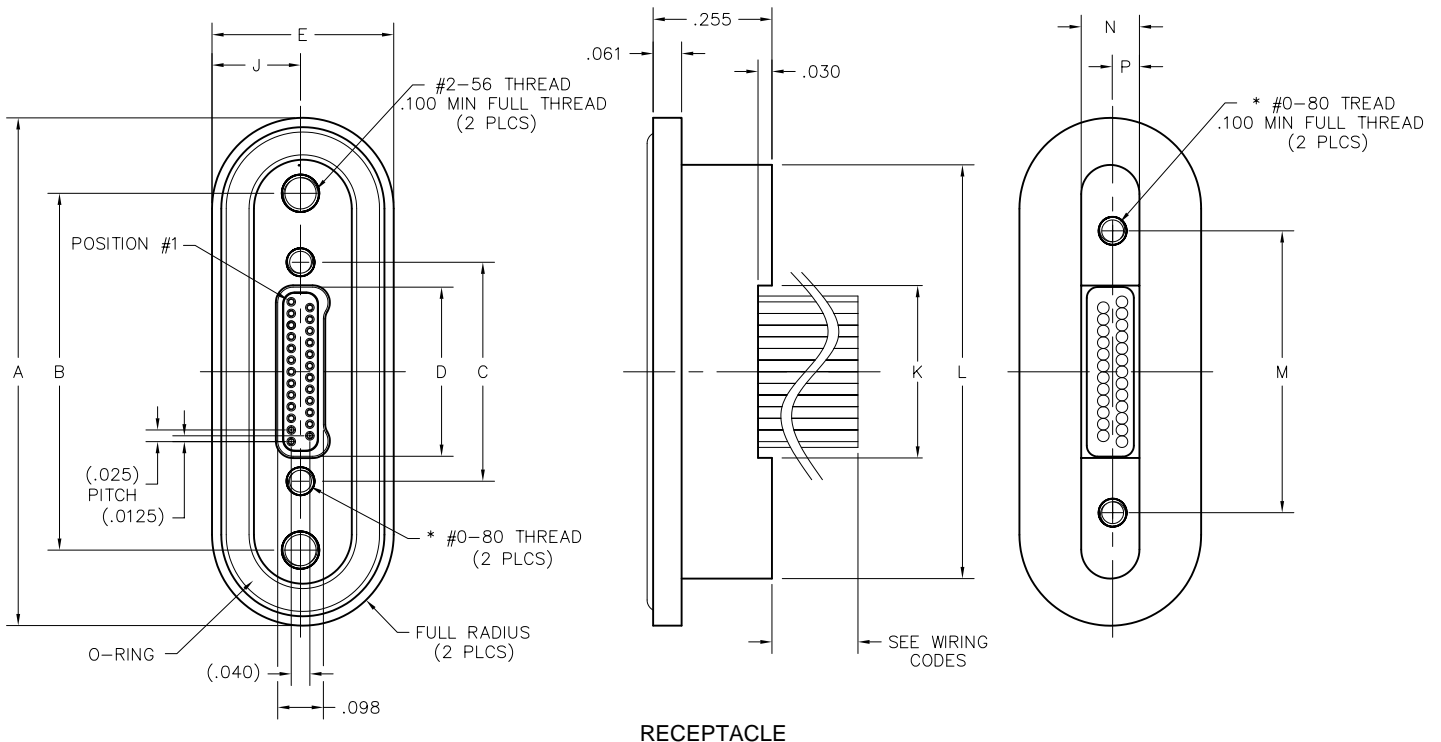
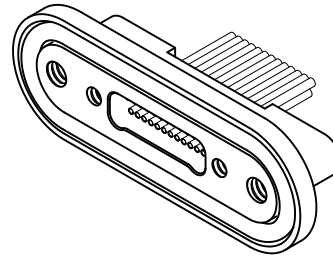

RECEPTACLE

DIMENSIONS											
SIZE	A	B	C	D	E	J	K	L	M	N	P
9	.890	.566	.270	.163	.390	.190	.170	.688	.405	.125	.0575
15	.965	.641	.345	.238			.245	.763	.480		
21	1.040	.716	.420	.313			.320	.838	.555		
25	1.090	.766	.470	.363			.370	.888	.605		
31	1.165	.841	.545	.438			.445	.963	.680		
37	1.240	.916	.620	.513			.520	1.038	.755		
51	1.415	1.091	.795	.688			.695	1.213	.930		
65	1.590	1.266	.970	.863			.870	1.388	1.105		
69	1.640	1.316	1.020	.913			.920	1.438	1.155		
85	1.892	1.568	1.246	1.113			.415	.2025	1.120		

* = #2-56 UNC THREAD ON 85 POSITION CONNECTORS.

RECEPTACLE: NMRP-224-025-261-TH00
 XXXX-XXX-XXX-XXX-XXXX-XXX

SERIES

NMRP .025" Metal I/O Connector

BODY

2 2-Row

BODY STYLE:

2 Receptacle, straight, rear panel mount with fluorosilicone o-ring

BODY MATERIAL:

4 Liquid Crystal Polymer w/ stainless steel shell

SIZE

XXX Number of contacts (009, 015, 021, 025, 031, 037, 051, 065, 069 or 085)

CONTACTS

TYPE CONTACTS/TERMINATIONS:

26 Socket, straight, crimped wire

PLATING OPTIONS:

1 50 u" Au contacts

HARDWARE

STYLE OF HARDWARE:

TH Threaded hole, #0-80 UNF*

WIRING OPTIONS:

XX See wiring codes, Page NA-2

OPTIONS

EMI EMI o-ring (in lieu of fluorosilicone o-ring)

* = #2-56 UNC thread on 85 position connectors
 Recommended torque value 1.0 inch-lbs. max. (#0-80 thread)
 Recommended torque value 2.0 inch-lbs. max. (#2-56 thread)

2 · ROW Rear Panel Mount Vertical SMT

.025"

NKRP

9 thru 85 Contacts

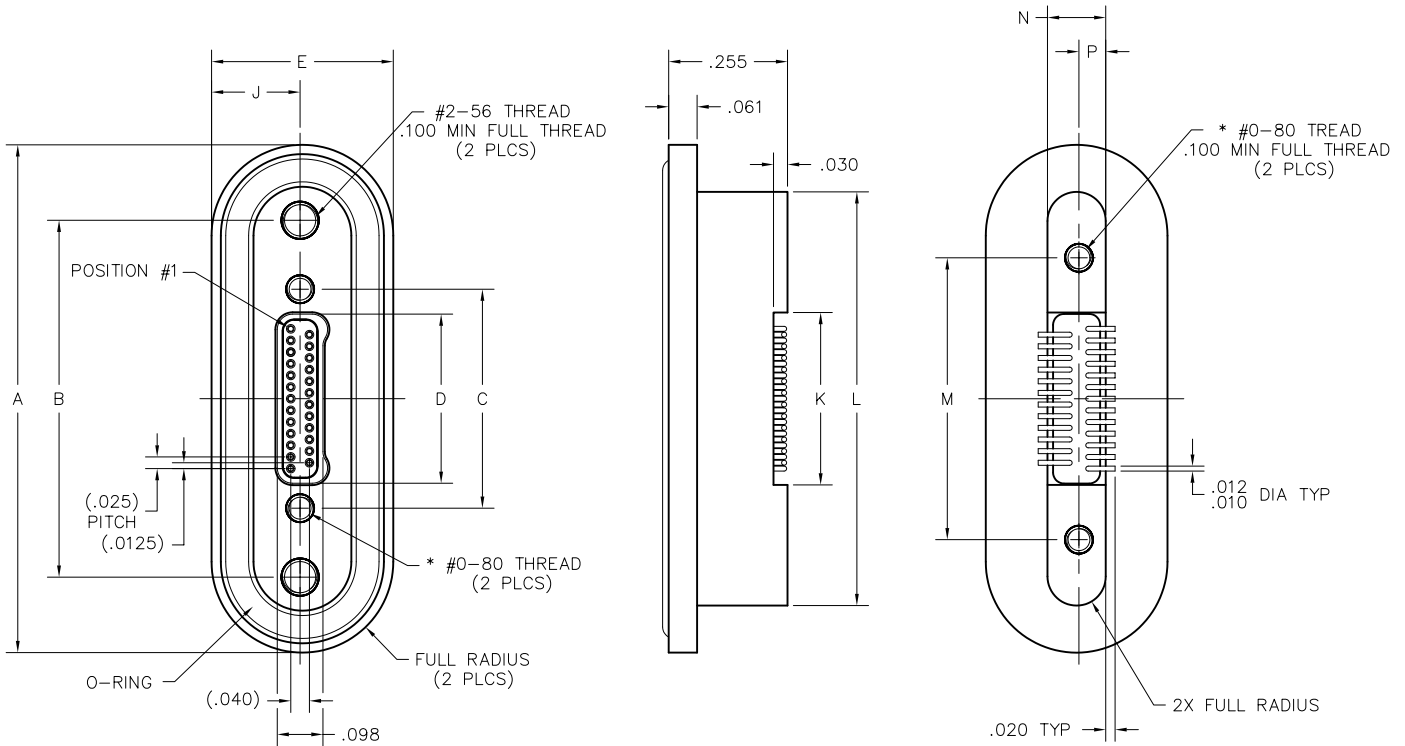
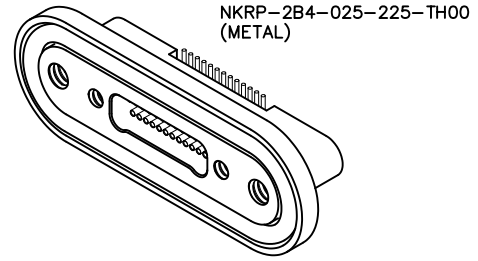

RECEPTACLE

DIMENSIONS											
SIZE	A	B	C	D	E	J	K	L	M	N	P
9	.890	.566	.270	.163	.390	.190	.170	.688	.405	.125	.0575
15	.965	.641	.345	.238			.245	.763	.480		
21	1.040	.716	.420	.313			.320	.838	.555		
25	1.090	.766	.470	.363			.370	.888	.605		
31	1.165	.841	.545	.438			.445	.963	.680		
37	1.240	.916	.620	.513			.520	1.038	.755		
51	1.415	1.091	.795	.688			.695	1.213	.930		
65	1.590	1.266	.970	.863			.870	1.388	1.105		
69	1.640	1.316	1.020	.913			.920	1.438	1.155		
85	1.892	1.568	1.246	1.113			.415	.2025	1.120		

* = #2-56 UNC THREAD ON 85 POSITION CONNECTORS.

RECEPTACLE: NKRP-2B4-025-225-TH00
 XXXX-XXX-XXX-XXX-XXXX-XXX

SERIES

NKRP .025" Metal PC Board Mounted Connector

BODY

2 2-Row

BODY STYLE:

B Receptacle, vertical SMT, rear panel mount with fluorosilicone o-ring

BODY MATERIAL:

4 Liquid Crystal Polymer w/ stainless steel shell

SIZE

XXX Number of contacts (009, 015, 021, 025, 031, 037, 051, 065, 069 or 085)

CONTACTS

TYPE CONTACTS/TERMINATIONS:

22 Socket, SMT

PLATING OPTIONS:

5 50 u" Au contacts; Sn/Pb alloy terminations
 8 50 u" Au contacts; Tin plated terminations

HARDWARE

STYLE OF HARDWARE:

TH Threaded hole, #0-80 UNF*

WIRING OPTIONS:

00 None

OPTIONS

EMI EMI o-ring (in lieu of fluorosilicone o-ring)

* = #2-56 UNC thread on 85 position connectors
 Recommended torque value 1.0 inch-lbs. max. (#0-80 thread)
 Recommended torque value 2.0 inch-lbs. max. (#2-56 thread)

= Option not RoHS compliant



Recommended PC Board Layout

Vertical SMT Rcpt
FOR REFERENCE ONLY

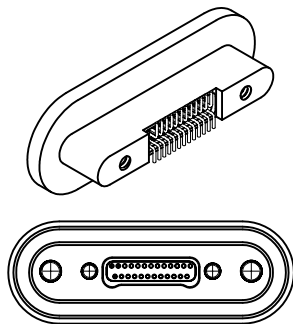

CONNECTOR MATING FACE

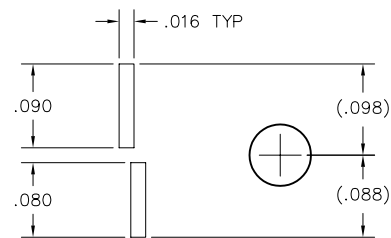

FOOTPRINT / PAD CONFIGURATION

9 POSITION

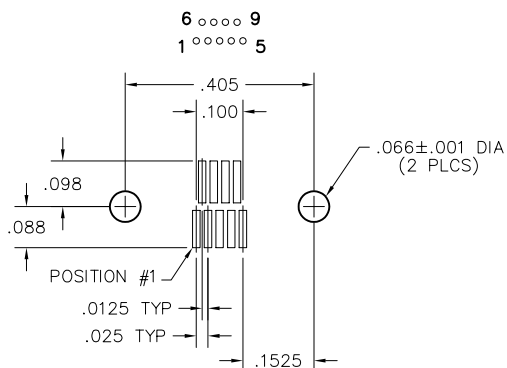

15 POSITION

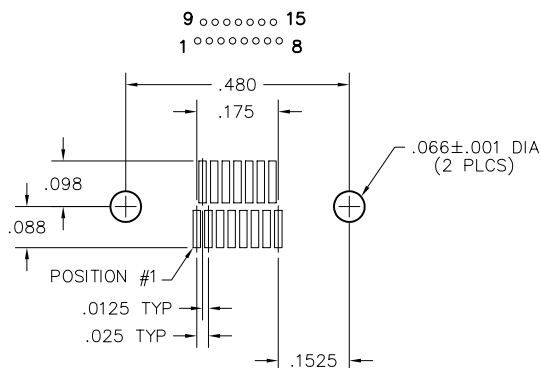

21 POSITION

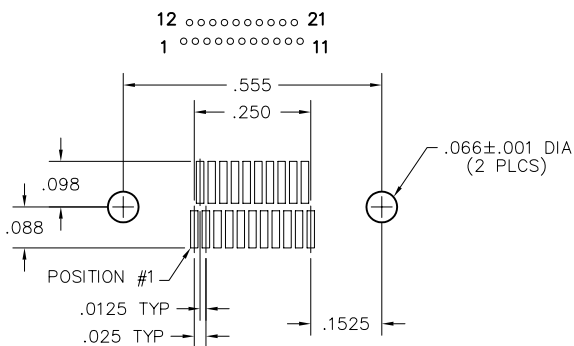

25 POSITION

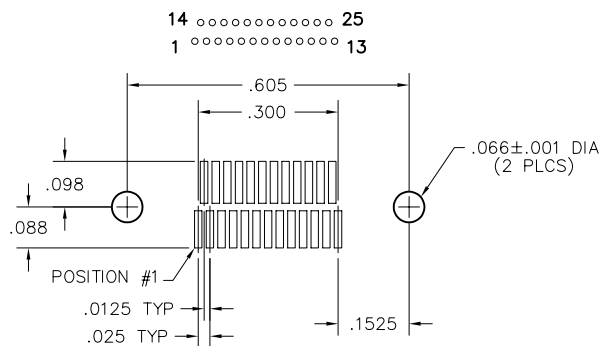

31 POSITION

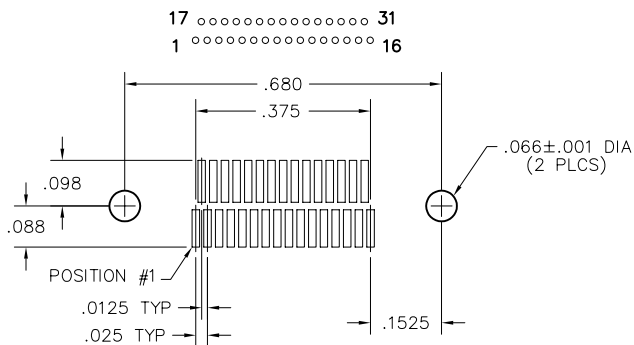

37 POSITION

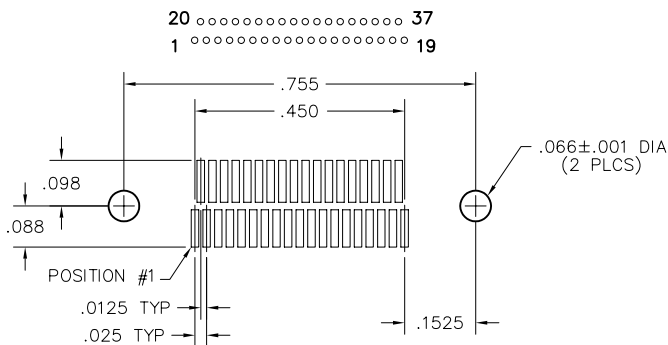

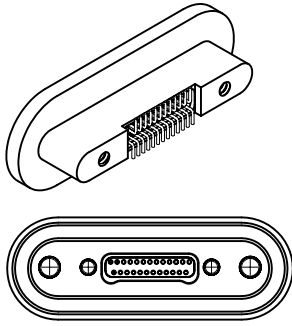

CONNECTOR MATING FACE

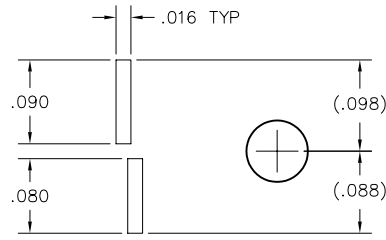

FOOTPRINT / PAD CONFIGURATION



Recommended PC Board Layout

Vertical SMT Rcpt
FOR REFERENCE ONLY

51 POSITION

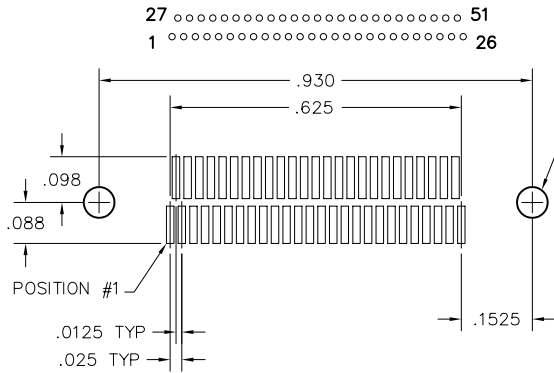

65 POSITION

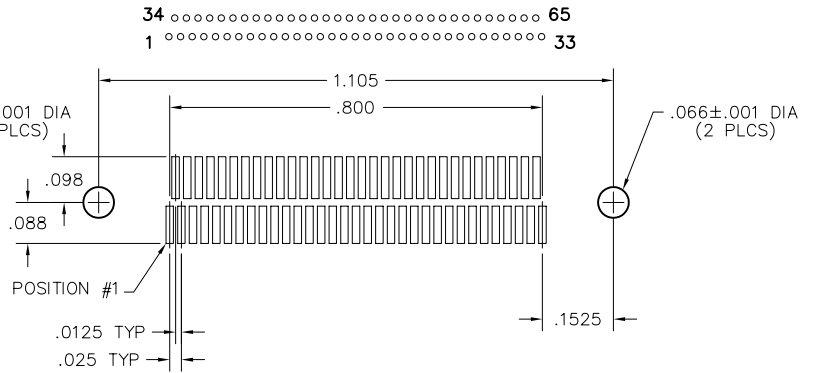

69 POSITION

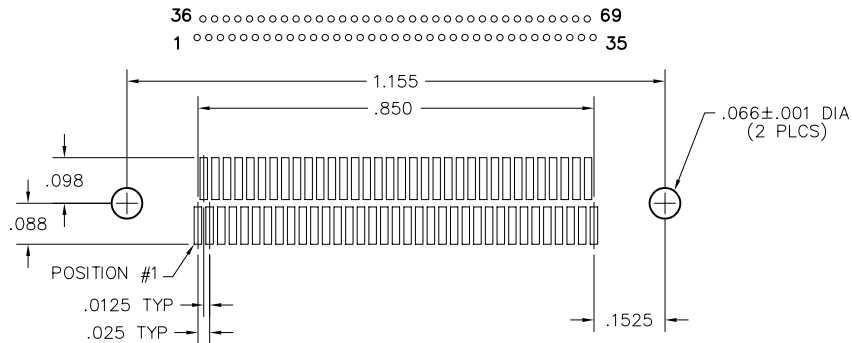

85 POSITION

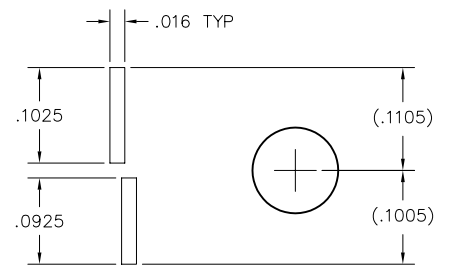
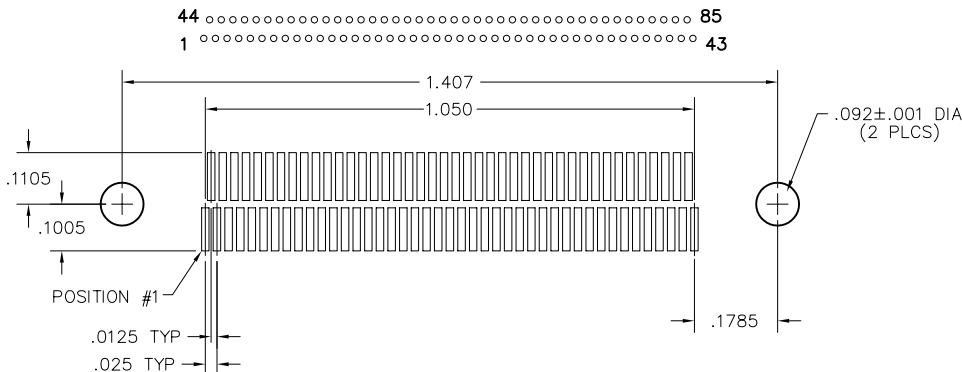

FOOTPRINT / PAD CONFIGURATION

2 · ROW Rear Panel Mount Horizontal SMT

.025"

NKRP

9 thru 85 Contacts

NKRP-2D4-025-225-TH00
(METAL)

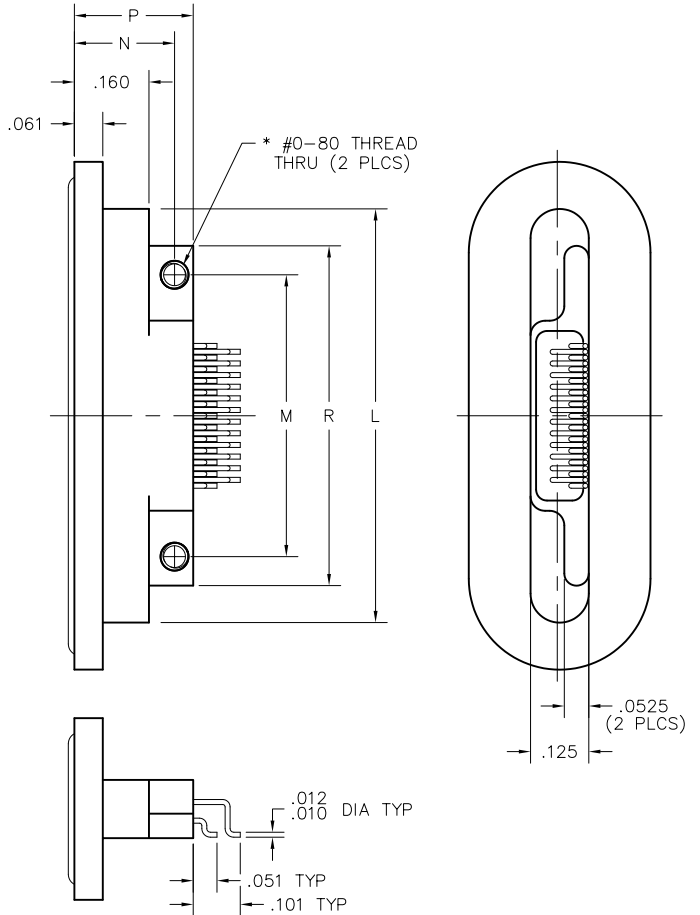
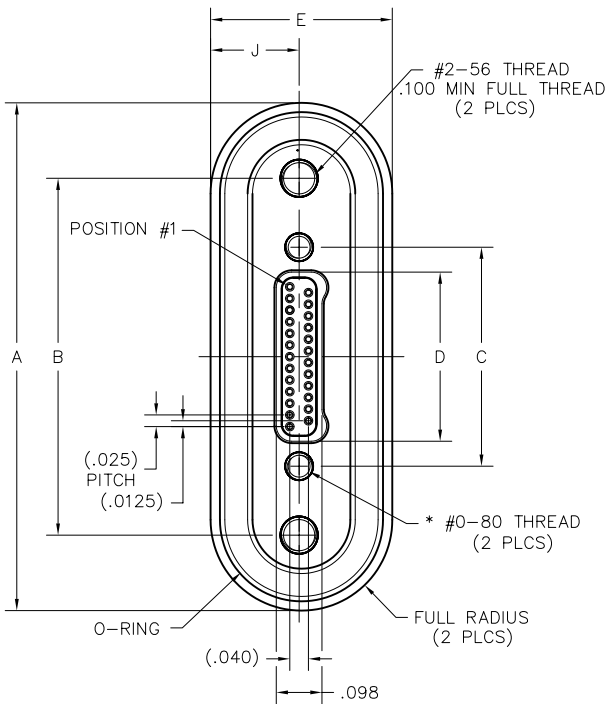
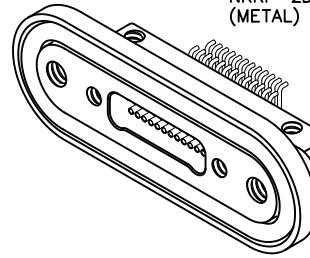

RECEPTACLE

DIMENSIONS											
SIZE	A	B	C	D	E	J	L	M	N	P	R
9	.890	.566	.270	.163	.390	.190	.688	.405	.215	.255	.531
15	.965	.641	.345	.238			.763	.480			.606
21	1.040	.716	.420	.313			.838	.555			.681
25	1.090	.766	.470	.363			.888	.605			.731
31	1.165	.841	.545	.438			.963	.680			.806
37	1.240	.916	.620	.513			1.038	.755			.881
51	1.415	1.091	.795	.688			1.213	.930			1.056
65	1.590	1.266	.970	.863			1.388	1.105			1.231
69	1.640	1.316	1.020	.913	1.438	1.155	1.281				
85	1.892	1.568	1.246	1.113	.415	.2025	1.690	1.407	.244	.300	1.533

* = #2-56 UNC THREAD ON 85 POSITION CONNECTORS.

RECEPTACLE: NKRP-2D4-025-225-TH00
 XXXX-XXX-XXX-XXX-XXXX-XXX

SERIES

NKRP .025" Metal PC Board Mounted Connector

BODY

2 2-Row

BODY STYLE:

D Receptacle, horizontal SMT, rear panel mount with fluorosilicone o-ring

BODY MATERIAL:

4 Liquid Crystal Polymer w/ stainless steel shell

SIZE

XXX Number of contacts (009, 015, 021, 025, 031, 037, 051, 065, 069 or 085)

CONTACTS

TYPE CONTACTS/TERMINATIONS:

22 Socket, SMT

PLATING OPTIONS:

5 50 u" Au contacts; Sn/Pb alloy terminations
 8 50 u" Au contacts; Tin plated terminations

HARDWARE

STYLE OF HARDWARE:

TH Threaded hole, #0-80 UNF*

WIRING OPTIONS:

00 None

OPTIONS

EMI EMI o-ring (in lieu of fluorosilicone o-ring)

* = #2-56 UNC thread on 85 position connectors
 Recommended torque value 1.0 inch-lbs. max. (#0-80 thread)
 Recommended torque value 2.0 inch-lbs. max. (#2-56 thread)

= Option not RoHS compliant



Recommended PC Board Layout

Horizontal SMT Rcpt
FOR REFERENCE ONLY

No solder mask allowed
within connector outline

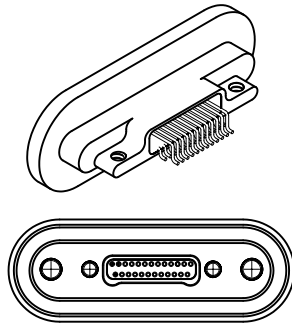

CONNECTOR MATING FACE

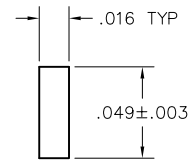

FOOTPRINT / PAD CONFIGURATION

9 POSITION

9 ○○○○ 6
5 ○○○○ 1

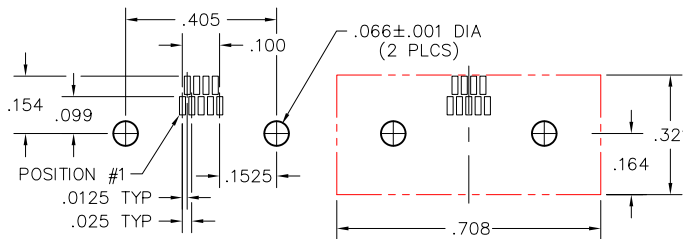

15 POSITION

15 ○○○○○○ 9
8 ○○○○○○ 1

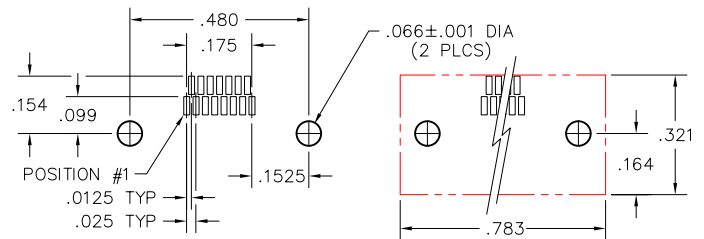

21 POSITION

21 ○○○○○○○○ 12
11 ○○○○○○○○ 1

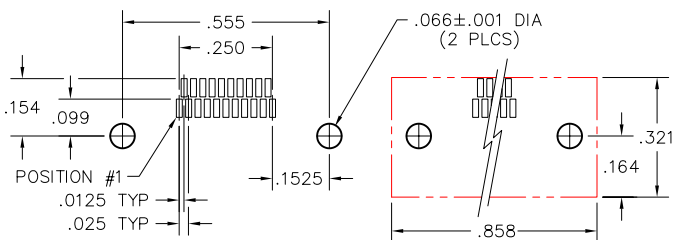

25 POSITION

25 ○○○○○○○○○○ 14
13 ○○○○○○○○○○ 1

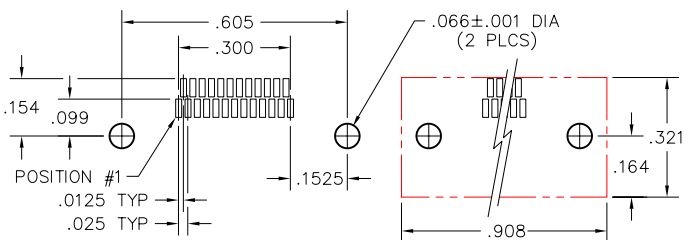

31 POSITION

31 ○○○○○○○○○○○○ 17
16 ○○○○○○○○○○○○ 1

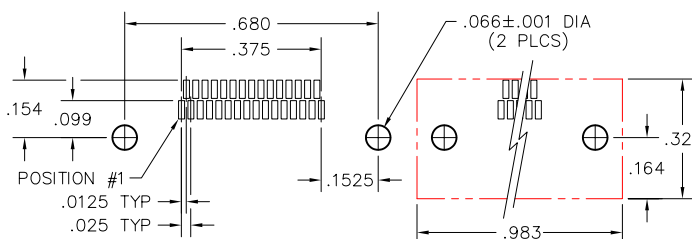

37 POSITION

37 ○○○○○○○○○○○○○○ 20
19 ○○○○○○○○○○○○○○ 1

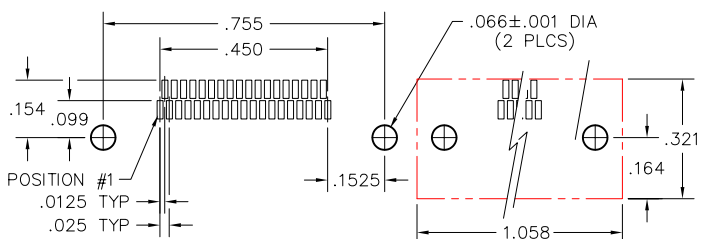

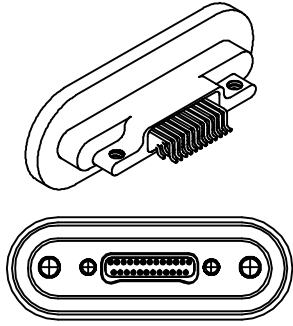

CONNECTOR MATING FACE

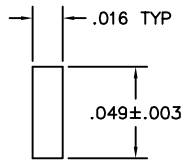

FOOTPRINT / PAD CONFIGURATION

Recommended PC Board Layout

Horizontal SMT Rcpt
FOR REFERENCE ONLY

No solder mask allowed
within connector outline

51 POSITION

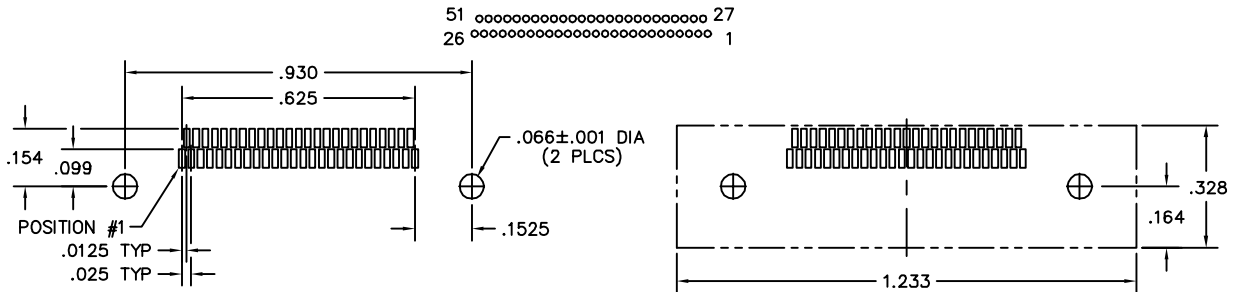

65 POSITION

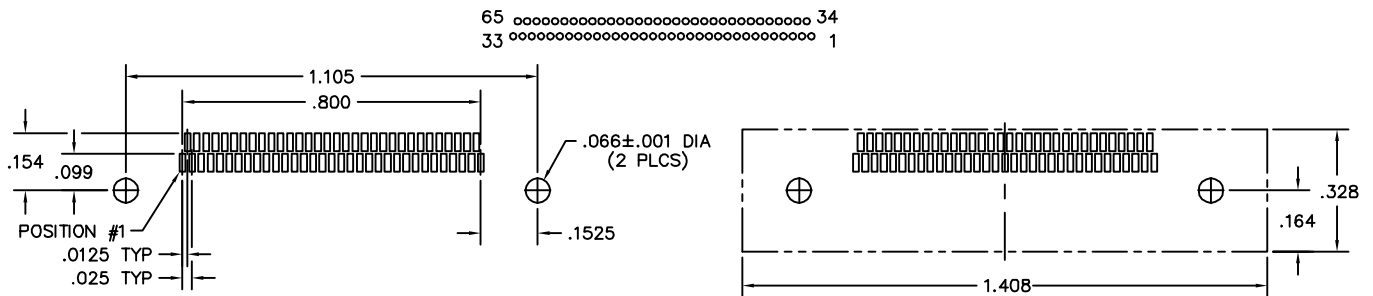

69 POSITION

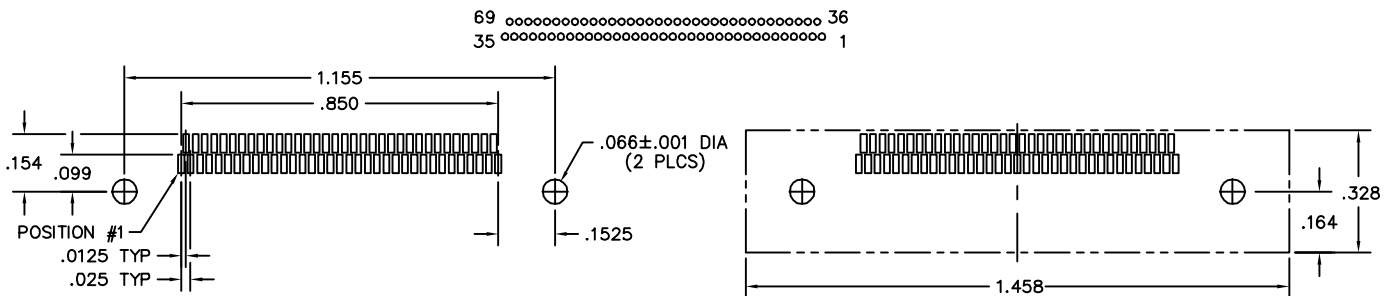

85 POSITION

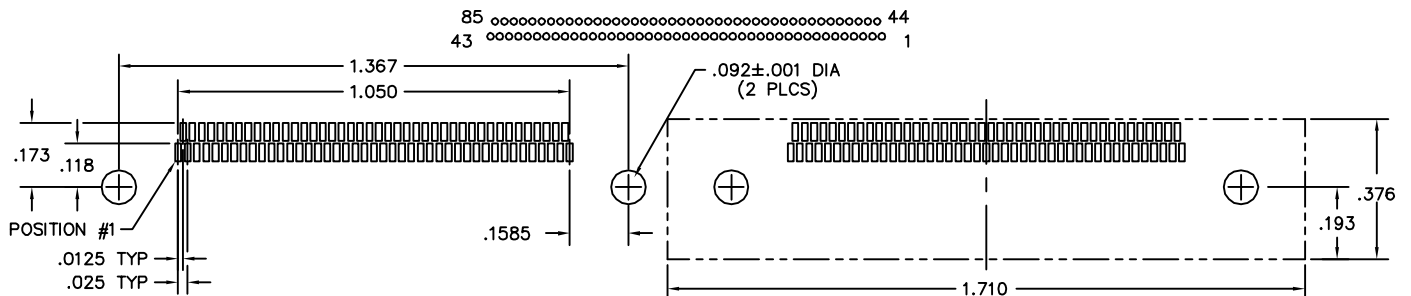

2 · ROW Rear Panel Mount Straddle Mount

.025"

NMRP

9 thru 85 Contacts

NMRP-224-025-225-TH00
(METAL)

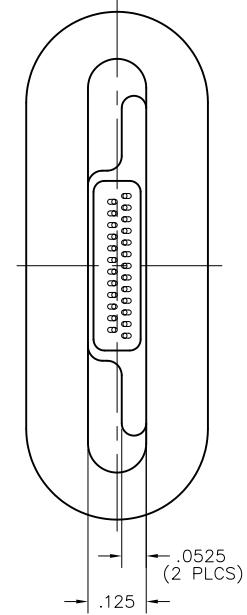
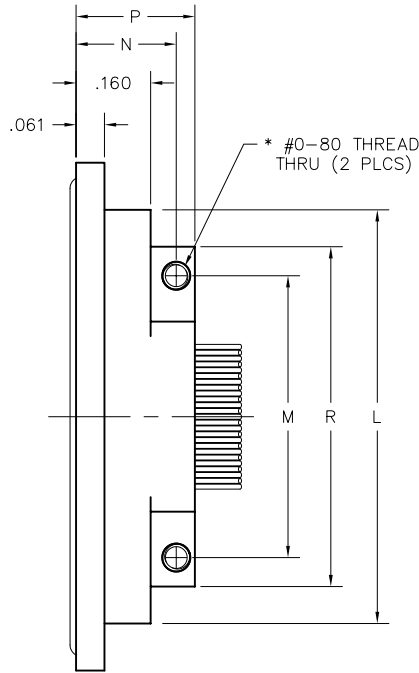
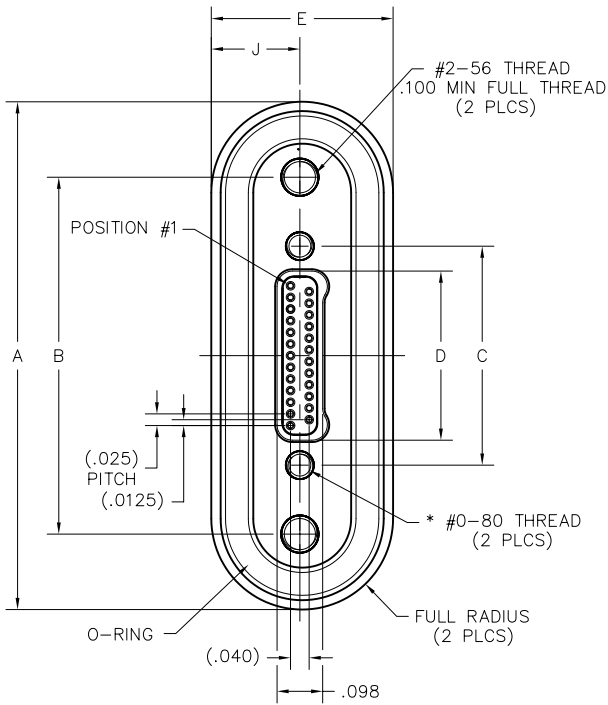
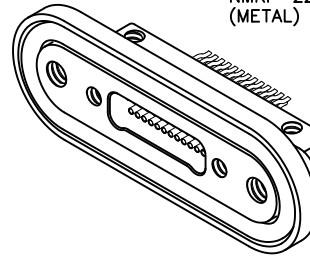

RECEPTACLE

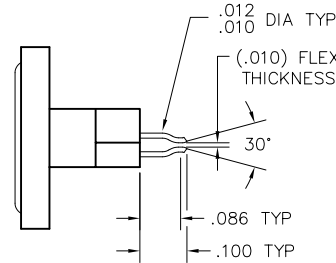

DIMENSIONS											
SIZE	A	B	C	D	E	J	L	M	N	P	R
9	.890	.566	.270	.163	.390	.190	.688	.405	.215	.255	.531
15	.965	.641	.345	.238			.763	.480			.606
21	1.040	.716	.420	.313			.838	.555			.681
25	1.090	.766	.470	.363			.888	.605			.731
31	1.165	.841	.545	.438			.963	.680			.806
37	1.240	.916	.620	.513			1.038	.755			.881
51	1.415	1.091	.795	.688			1.213	.930			1.056
65	1.590	1.266	.970	.863			1.388	1.105			1.231
69	1.640	1.316	1.020	.913	1.438	1.155	1.281				
85	1.892	1.568	1.246	1.113	.415	.2025	1.690	1.367	.244	.300	1.533

* = #2-56 UNC THREAD ON 85 POSITION CONNECTORS.

RECEPTACLE: NMRP-224-025-225-TH00
 XXXX-XXX-XXX-XXX-XXXX-XXX

SERIES

NMRP .025" Metal Straddle Mount Flex Connector

BODY

2 2-Row

BODY STYLE:

2 Receptacle, straight, rear panel mount with fluorosilicone o-ring

BODY MATERIAL:

4 Liquid Crystal Polymer w/ stainless steel shell

SIZE

XXX Number of contacts (009, 015, 021, 025, 031, 037, 051, 065, 069 or 085)

CONTACTS

TYPE CONTACTS/TERMINATIONS:

22 Socket, SMT

PLATING OPTIONS:

5 50 u" Au contacts; Sn/Pb alloy terminations
 8 50 u" Au contacts; Tin plated terminations

HARDWARE

STYLE OF HARDWARE:

TH Threaded hole, #0-80 UNF*

WIRING OPTIONS:

00 None

OPTIONS

EMI EMI o-ring (in lieu of fluorosilicone o-ring)

* = #2-56 UNC thread on 85 position connectors
 Recommended torque value 1.0 inch-lbs. max. (#0-80 thread)
 Recommended torque value 2.0 inch-lbs. max. (#2-56 thread)

= Option not RoHS compliant



Recommended PC Board Layout

Straddle Mount Rcpt
FOR REFERENCE ONLY

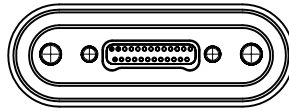
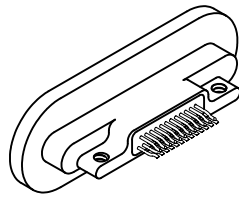

CONNECTOR MATING FACE

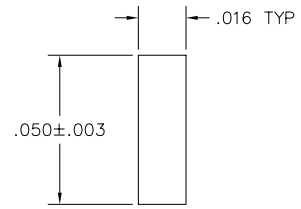

FOOTPRINT / PAD CONFIGURATION

9 POSITION

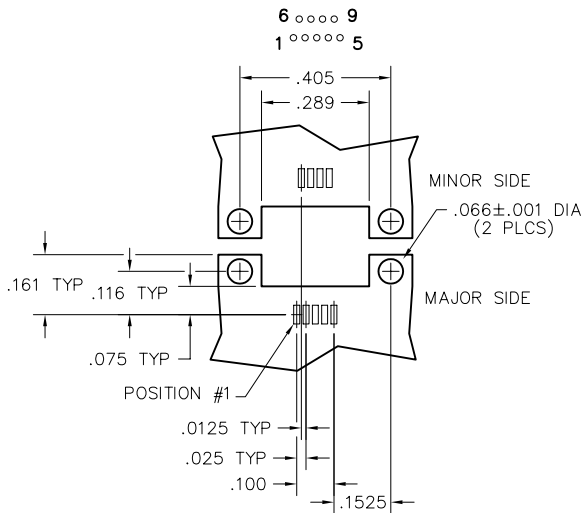

15 POSITION

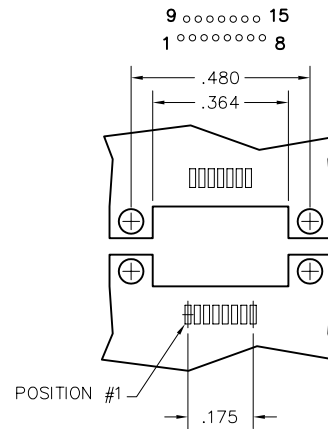

21 POSITION

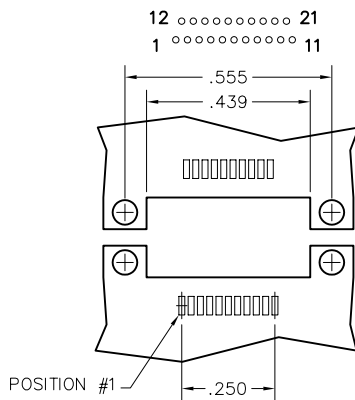

25 POSITION

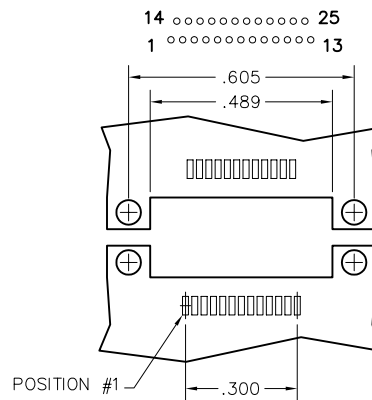

31 POSITION

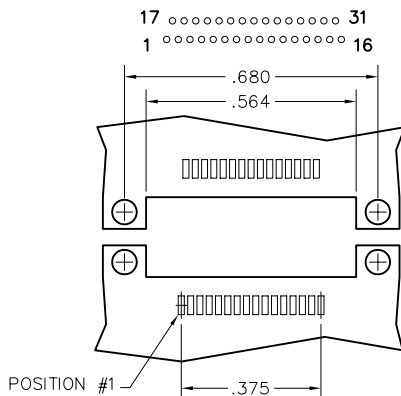

37 POSITION

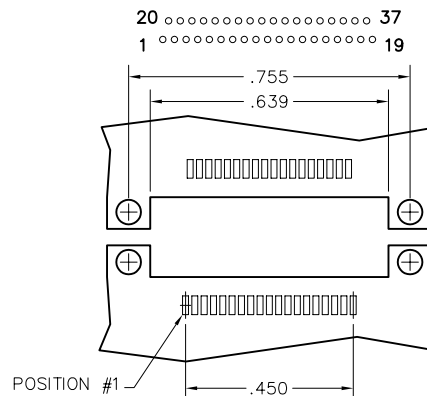

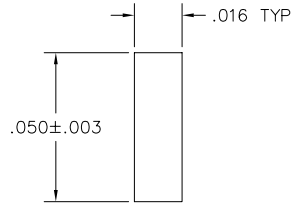
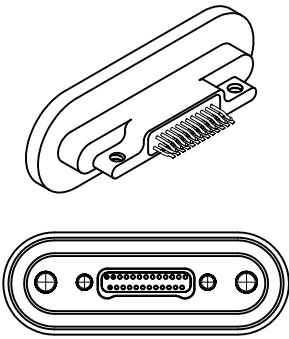

Recommended PC Board Layout

Straddle Mount Rcpt
FOR REFERENCE ONLY

FOOTPRINT / PAD CONFIGURATION

CONNECTOR MATING FACE

51 POSITION

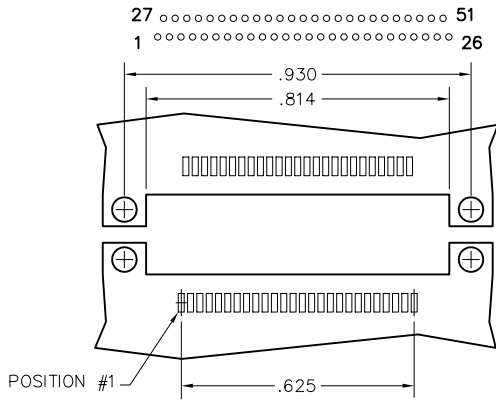

65 POSITION

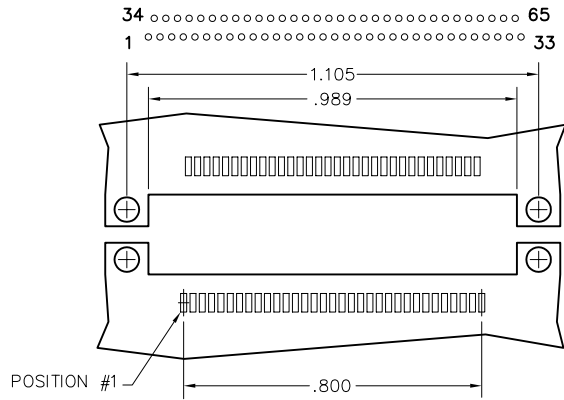

69 POSITION

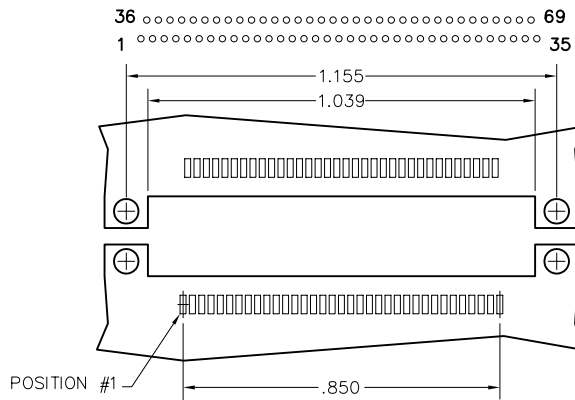

85 POSITION

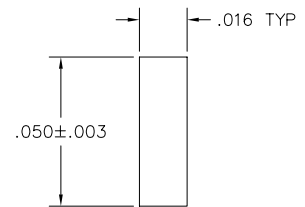
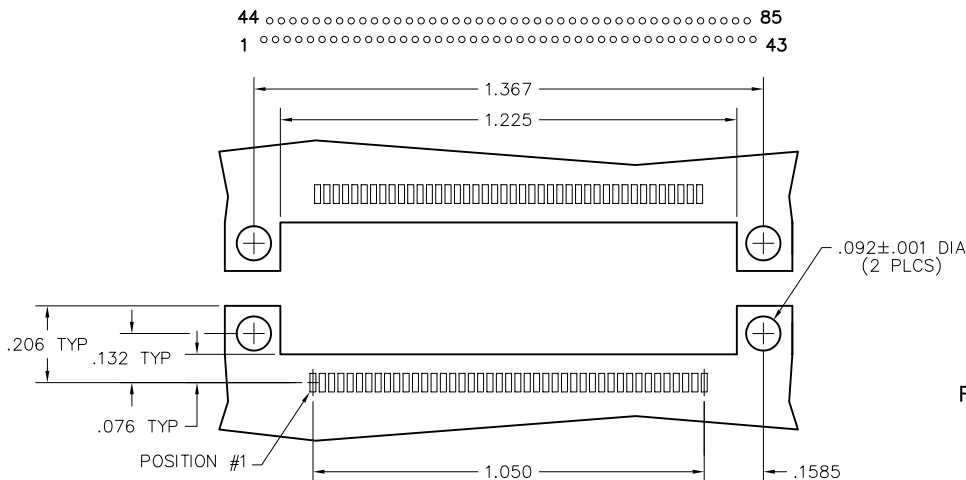

FOOTPRINT / PAD CONFIGURATION



Panel Mounting Dimensions for Rear Panel Mount Connectors

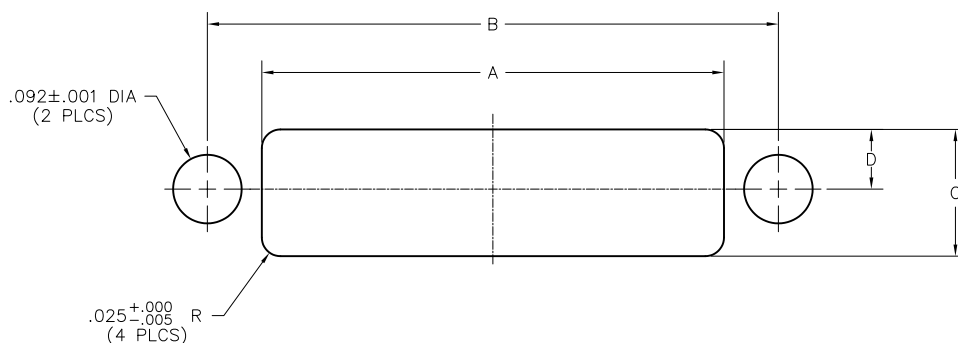

DIMENSIONS				
SIZE	A $\begin{smallmatrix} +.004 \\ -.000 \end{smallmatrix}$	B $\pm .002$	C $\begin{smallmatrix} +.004 \\ -.000 \end{smallmatrix}$	D $\pm .001$
9	.420	.566	.170	.080
15	.495	.641	.170	.080
21	.570	.716	.170	.080
25	.620	.766	.170	.080
31	.695	.841	.170	.080
37	.770	.916	.170	.080
51	.945	1.091	.170	.080
65	1.120	1.266	.170	.080
69	1.170	1.316	.170	.080
85	1.422	1.568	.195	.0925

Specifications - Circular Connectors Materials and Finishes *

Contacts:	Pins: BeCu alloy strip per ASTM-B-194 Sockets: BeCu per ASTM-B-194 or NiAg per ASTM-B-122
Embedment:	Insulating compound per MIL-I-16923
Contact Finish:	Gold plate per ASTM B 488, SAE AMS 2422
Molded Insulators:	Glass filled liquid crystal polymer (LCP) per ASTM D5138
Shell:	Copper Alloy per ASTM B16
Shell Finishes:	Electroless Nickel per SAE AMS-C-26074
Quick Release Coupling Rings & Jam Nuts:	Copper Alloy per ASTM B16
Quick Release Coupling Ring & Jam Nut Finish:	Electroless Nickel per SAE AMS-C-26074
Threaded Coupling Rings:	Corrosion resistant steel per ASTM A484 / A484M and ASTM A582 / A582M
Threaded Coupling Ring Finish:	Passivate per SAE AMS-2700
Lock Rings:	BeCu Alloy per ASTM B196
Lock Ring Finish:	Electroless Nickel per SAE AMS-C-26074
O-rings:	Fluorosilicone elastomer per AMS-R-25988
Tolerances:	Unless otherwise specified: Decimals = .XXX = ± 0.005 " .XXXX = ± 0.0050 " Angles = $\pm 2^\circ$

Note: AirBorn can manufacture special configurations for your exact specifications.

* = Reference the above listed specifications or an equivalent industry standard when applicable

Performance - Circular Connectors

Reference M32139

AirBorn "N" Series Circular meets or exceeds M32139 Performance Specifications

Contact Rating:	1-amperes maximum
Solderability:	Terminals (except crimp) tested in accordance with MIL-STD-202, Method 208
Wire Size:	Stranded #30 & #32 AWG or solid #30 AWG standard (consult factory for other sizes and types)
Test Voltage:	250 V, RMS, 60 Hz
Operating Temperature:	-55° C to +125° C
Insulation Resistance:	5,000 megohms minimum @ 100 VDC
Durability:	200 connector mating cycles tested in accordance with EIA-364-09
Vibration:	Tested in accordance with EIA-364-28, Condition IV
Shock:	Tested in accordance with EIA-364-27, Condition G
Salt Spray:	Mated connectors tested in accordance with EIA-364-26, Condition B
Humidity:	Mated connectors tested in accordance with EIA-364-31, Condition B (except steps 7a and 7b)
Thermal Shock:	Tested to the temperature extremes of EIA-364-32, Condition I (except step 3, temperature shall be 125° C)
Contact Resistance:	0.021 volt maximum drop @ 1.0 amps (.021 ohms)
Contact Engaging Force:	5.0 ounce maximum, with minimum diameter test sleeve
Contact Separating Force:	0.4 ounce minimum, with maximum diameter test sleeve
Crimp Strength:	1 pound minimum tensile strength

NC-141-007-261-00AC

Circular Cable Connectors with Quick Release

NC
7 & 19 Contacts

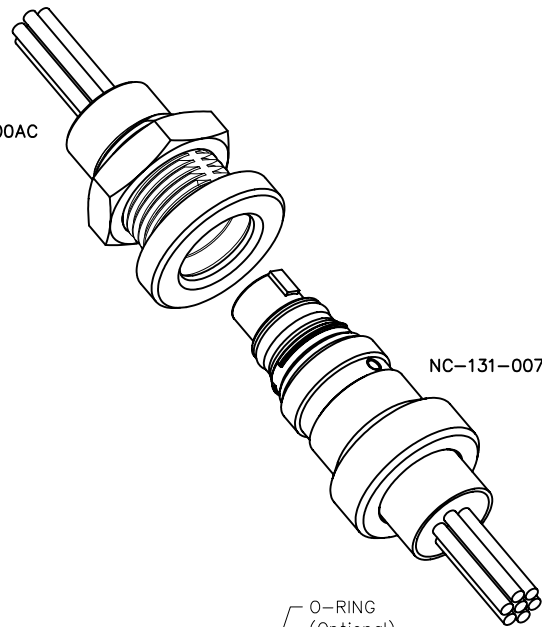

NC-131-007-161-00AC

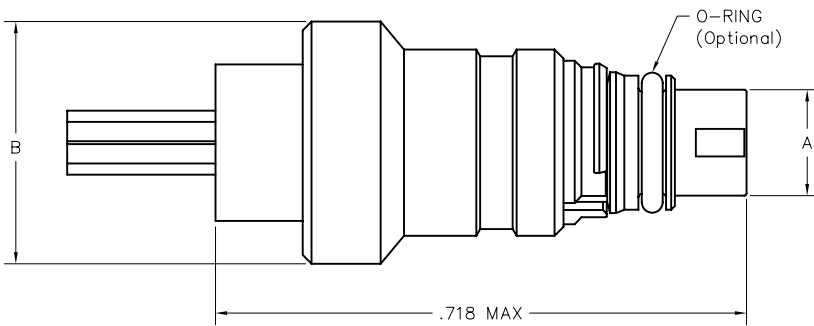

PLUG QUICK RELEASE (Socket Contacts)
Mates with Front and Rear Panel Receptacles

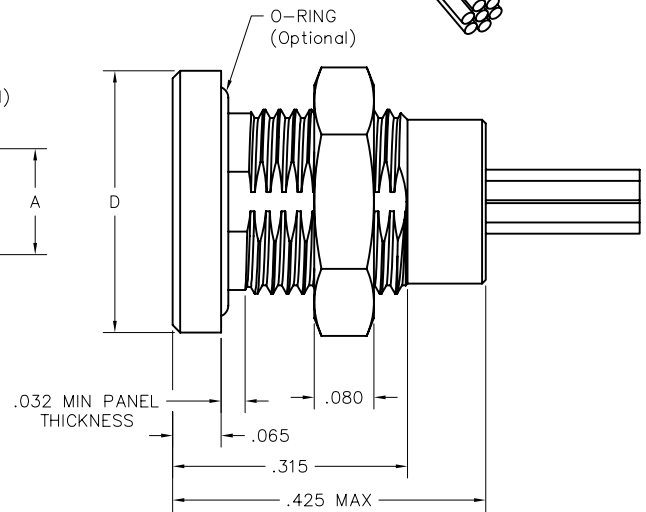

RECEPTACLE FRONT PANEL MOUNT (Pin Contacts)

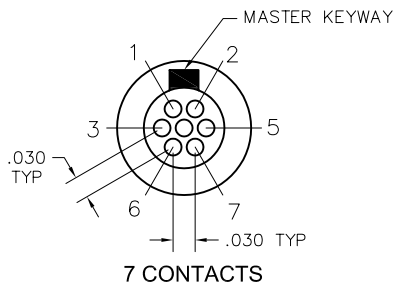

7 CONTACTS

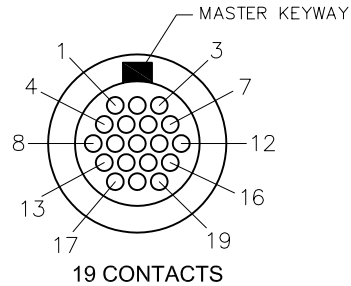

19 CONTACTS

Contact Arrangements

Face view, receptacle (Pin Contacts)

Cavity identification numbers are for reference and do not appear on connector.

PLUG DIMENSIONS			
MOUNT	SIZE	A MAX DIA	B MAX DIA
QUICK RELEASE	7 POS	.145	.330
	19 POS	.205	.326

RECEPTACLE DIMENSIONS			
MOUNT	SIZE	D MAX DIA	E THREAD
FRONT PANEL	7 POS	.356	.25-48 UNS-2A
	19 POS	.419	.3125-48 UNS-2A

Call (972) 931-3200 · Fax (972) 931-9305 · www.AirBorn.com

PLUG: NC-131-007-161-00AC
RECEPTACLE: NC-141-007-261-00AC
 XX-XXX-XXX-XXX-XXXX

PLUG

RECEPTACLE

SERIES

NC Circular Connector

NC Circular Connector

BODY

- 1 7 Position Shell
- 2 19 Position Shell

- 1 7 Position Shell
- 2 19 Position Shell

BODY STYLE:

- 1 Quick Release
- 3 Quick Release with o-ring

BODY STYLE:

- 2 Front Mount
- 4 Front Mount with o-ring
- 6 Rear Mount
- 8 Rear Mount with o-ring

BODY MATERIAL:

- 1 Liquid Crystal Polymer Insulator
Brass shell with Electroless nickel plating

BODY MATERIAL:

- 1 Liquid Crystal Polymer Insulator
Brass shell with Electroless nickel plating

SIZE

XXX Number of contacts (007 & 019)

XXX Number of contacts (007 & 019)

CONTACTS

TYPE CONTACTS/TERMINATIONS:

- 14 Socket, straight, .500" (.010 dia.)
- 16 Socket, straight, crimped wire

TYPE CONTACTS/TERMINATIONS:

- 24 Pin, straight, .500" (.010 dia.)
- 26 Pin, straight, crimped wire

PLATING OPTIONS:

- 1 50 u" Au contacts (crimped wire)
- 5 50 u" Au contacts; Sn/Pb alloy terminations
- 8 50 u" Au contacts; Tin plated terminations

PLATING OPTIONS:

- 1 50 u" Au contacts (crimped wire)
- 5 50 u" Au contacts; Sn/Pb alloy terminations
- 8 50 u" Au contacts; Tin plated terminations

HARDWARE

STYLE OF HARDWARE:

- 00 None

STYLE OF HARDWARE:

- 00 Jam nut

WIRING OPTIONS:

- 00 None
- XX See wiring codes, Page NA-2

WIRING OPTIONS:

- 00 None
- XX See wiring codes, Page NA-2

= Option not RoHS compliant

NC-181-007-261-00AC

Circular Cable Connectors with Threaded Coupling

NC

7 & 19 Contacts

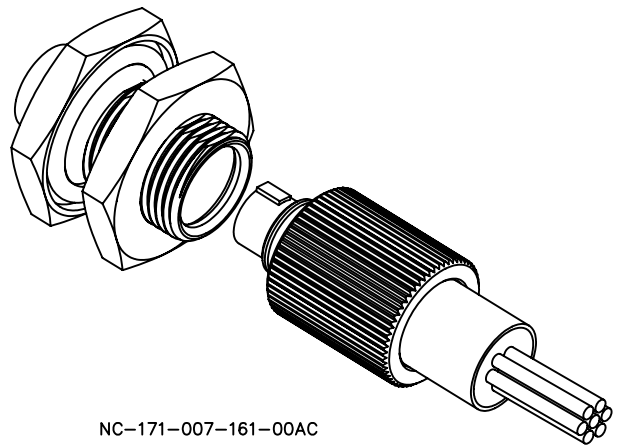

NC-171-007-161-00AC

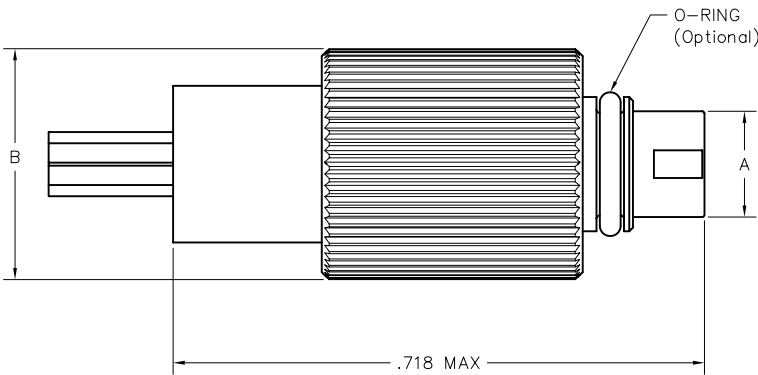

**PLUG
THREADED COUPLING**
(Socket Contacts)
Mates with Rear Panel
Receptacle Only

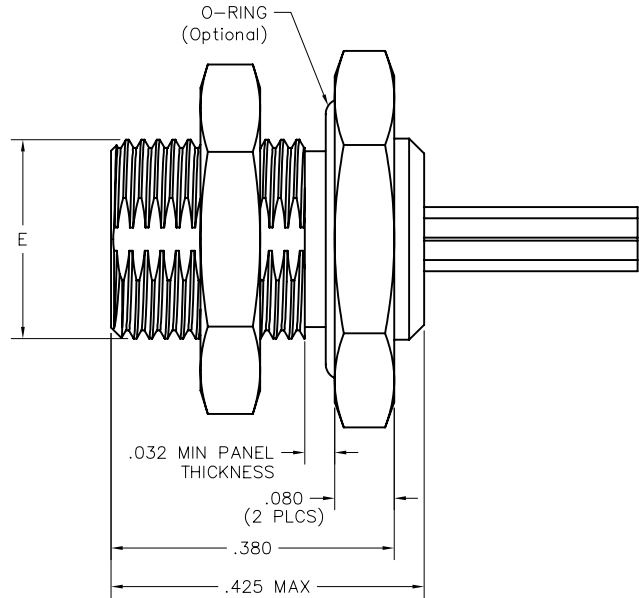

**RECEPTACLE
REAR PANEL MOUNT**
(Pin Contacts)

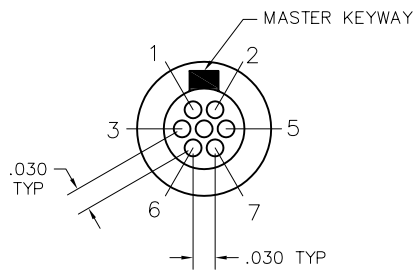

7 CONTACTS

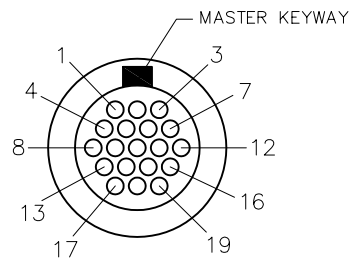

19 CONTACTS

Contact Arrangements

Face view, receptacle (Pin Contacts)

Cavity identification numbers are for reference and do not appear on connector.

DIMENSIONS (PLUG)			
MOUNT	SIZE	A MAX DIA	B MAX DIA
THREADED COUPLING	7 POS	.145	.315
	19 POS	.205	.374

DIMENSIONS (RECEPTACLE)		
MOUNT	SIZE	E THREAD
REAR PANEL	7 POS	.270-48 UNS-2A
	19 POS	.3281-48 UNS-2A

Call (972) 931-3200 · Fax (972) 931-9305 · www.AirBorn.com

PLUG: NC-171-007-161-00AC
RECEPTACLE: NC-181-007-261-00AC
 XX-XXX-XXX-XXX-XXXX

PLUG

RECEPTACLE

SERIES

NC Circular Connector

NC Circular Connector

BODY

- 1 7 Position Shell
- 2 19 Position Shell

- 1 7 Position Shell
- 2 19 Position Shell

BODY STYLE:

- 5 Threaded Coupling
- 7 Threaded Coupling with o-ring

BODY STYLE:

- 6 Rear Mount
- 8 Rear Mount with o-ring

BODY MATERIAL:

- 1 Liquid Crystal Polymer Insulator
Brass shell with Electroless nickel plating

BODY MATERIAL:

- 1 Liquid Crystal Polymer Insulator
Brass shell with Electroless nickel plating

SIZE

XXX Number of contacts (007 & 019)

XXX Number of contacts (007 & 019)

CONTACTS

TYPE CONTACTS/TERMINATIONS:

- 14 Socket, straight, .500" (.010 dia.)
- 16 Socket, straight, crimped wire

TYPE CONTACTS/TERMINATIONS:

- 24 Pin, straight, .500" (.010 dia.)
- 26 Pin, straight, crimped wire

PLATING OPTIONS:

- 1 50 u" Au contacts (crimped wire)
- 5 50 u" Au contacts; Sn/Pb alloy terminations
- 8 50 u" Au contacts; Tin plated terminations

PLATING OPTIONS:

- 1 50 u" Au contacts (crimped wire)
- 5 50 u" Au contacts; Sn/Pb alloy terminations
- 8 50 u" Au contacts; Tin plated terminations

HARDWARE

STYLE OF HARDWARE:

- 00 None

STYLE OF HARDWARE:

- 00 Jam nut

WIRING OPTIONS:

- 00 None
- XX See wiring codes, Page NA-2

WIRING OPTIONS:

- 00 None
- XX See wiring codes, Page NA-2

= Option not RoHS compliant

Circular Connectors Panel Mounting Dimensions

FRONT PANEL MOUNT

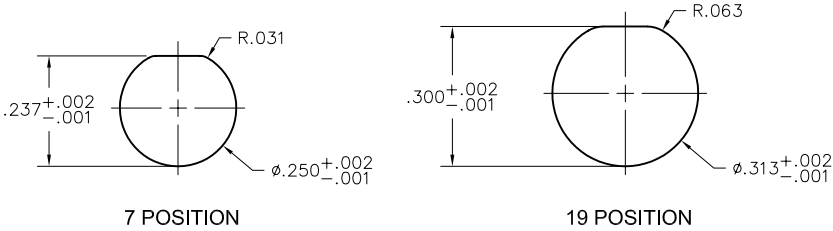

REAR PANEL MOUNT

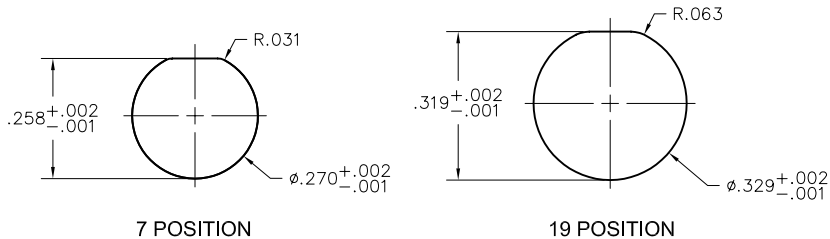

"N" SERIES ACCESSORIES

AirBorn Standard Nano Wire Codes

Wire Code	Wire Size	Wire Spec	Wire Color	Wire Length (+1.0"/-0.0")
AA	30 AWG	NEMA HP3	Color Coded *	6.0
AB	30 AWG	NEMA HP3	Color Coded *	12.0
AC	30 AWG	NEMA HP3	Color Coded *	18.0
AD	30 AWG	NEMA HP3	Color Coded *	36.0
AE	30 AWG	NEMA HP3	White	6.0
AF	30 AWG	NEMA HP3	White	12.0
AG	30 AWG	NEMA HP3	White	18.0
AH	30 AWG	NEMA HP3	White	36.0
AJ	30 AWG	NEMA HP3	Yellow	6.0
AK	30 AWG	NEMA HP3	Yellow	12.0
AL	30 AWG	NEMA HP3	Yellow	18.0
AM	30 AWG	NEMA HP3	Yellow	36.0
AN	32 AWG	NEMA HP3	Color Coded *	6.0
AP	32 AWG	NEMA HP3	Color Coded *	12.0
AQ	32 AWG	NEMA HP3	Color Coded *	18.0
AR	32 AWG	NEMA HP3	Color Coded *	36.0
AS	32 AWG	NEMA HP3	White	6.0
AT	32 AWG	NEMA HP3	White	12.0
AU	32 AWG	NEMA HP3	White	18.0
AV	32 AWG	NEMA HP3	White	36.0
AW	32 AWG	NEMA HP3	Yellow	6.0
AX	32 AWG	NEMA HP3	Yellow	12.0
AY	32 AWG	NEMA HP3	Yellow	18.0
AZ	32 AWG	NEMA HP3	Yellow	36.0
BA	30 AWG	SAE-AS22759/33 ☒	Color Coded *	6.0
BB	30 AWG	SAE-AS22759/33 ☒	Color Coded *	12.0
BC	30 AWG	SAE-AS22759/33 ☒	Color Coded *	18.0
BD	30 AWG	SAE-AS22759/33 ☒	Color Coded *	36.0
BE	30 AWG	SAE-AS22759/33 ☒	White	6.0
BF	30 AWG	SAE-AS22759/33 ☒	White	12.0
BG	30 AWG	SAE-AS22759/33 ☒	White	18.0
BH	30 AWG	SAE-AS22759/33 ☒	White	36.0
CA	30 AWG	04047-30A ☒	Color Coded *	6.0
CB	30 AWG	04047-30A ☒	Color Coded *	12.0
CC	30 AWG	04047-30A ☒	Color Coded *	18.0
CD	30 AWG	04047-30A ☒	Color Coded *	36.0
CE	30 AWG	04047-30A ☒	White	6.0
CF	30 AWG	04047-30A ☒	White	12.0
CG	30 AWG	04047-30A ☒	White	18.0
CH	30 AWG	04047-30A ☒	White	36.0

- NEMA HP3 has replaced MIL-W-16878/6 TFE 7-strand ET
- Consult factory for other available wire types.

* = Color coding in accordance with MIL-STD-681, System I, except using ten solid colors only in repeating sequence.

☒ = Option not RoHS compliant

2 · ROW BACKSHELLS

NM

Size 9 thru 91

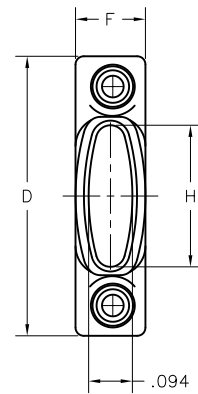
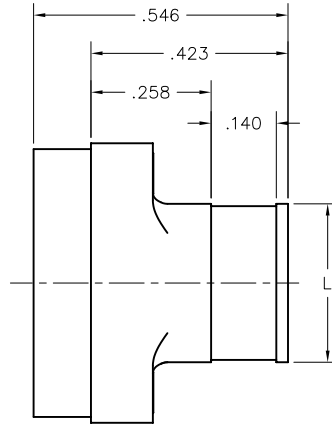
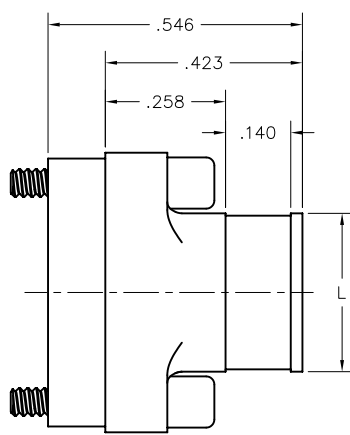
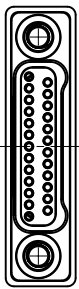
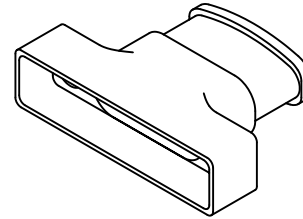

RECEPTACLE

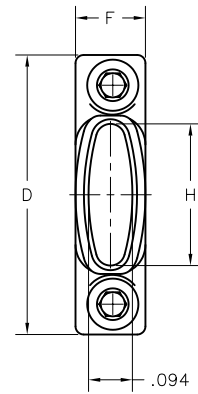
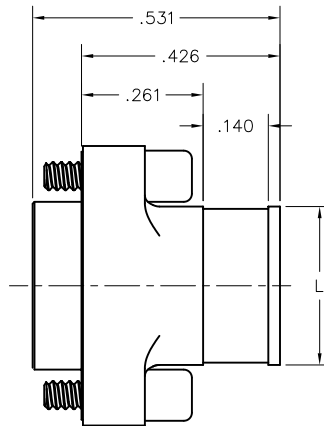
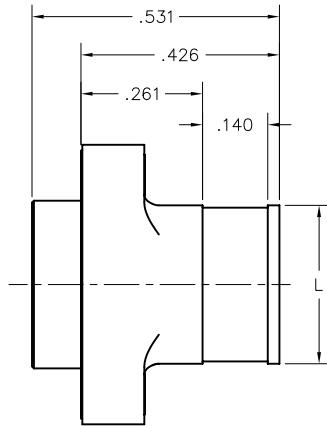
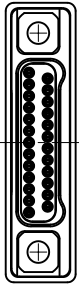

PLUG

DIMENSIONS					
SIZE	D	F	H	L	HARDWARE
9	.400	.150	.104	.140	#0-80
15	.475		.179	.215	
21	.550		.254	.290	
25	.600		.304	.340	
31	.675		.379	.415	
37	.750		.454	.490	
51	.925		.629	.665	
65	1.100	.175	.804	.840	#2-56
69	1.150		.854	.890	
85	1.402		1.054	1.090	
91	1.477		1.129	1.165	

THESE BACKSHELLS ARE AVAILABLE FACTORY INSTALLED ONLY, SEE PAGE N-38

Call (972) 931-3200 Fax (972) 931-9305 www.AirBorn.com

1 · ROW BACKSHELLS

NM

Size 9 thru 51

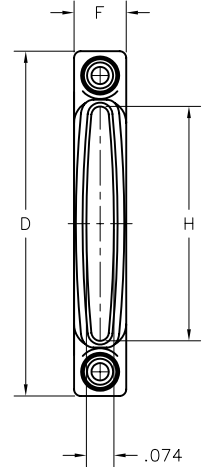
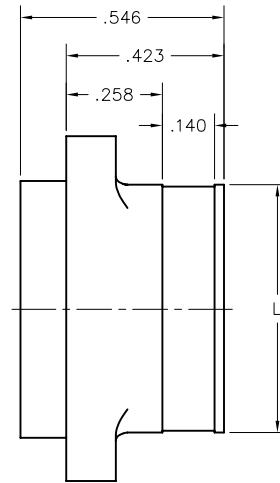
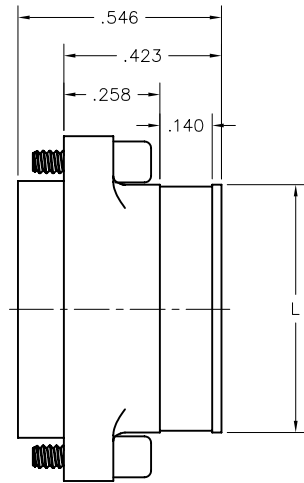
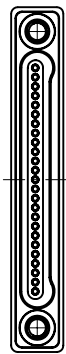

RECEPTACLE

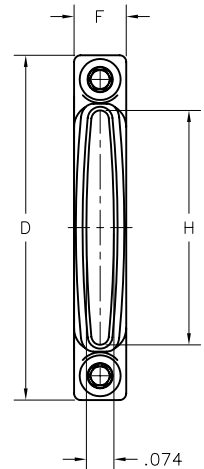
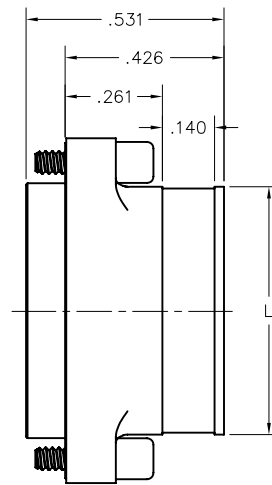
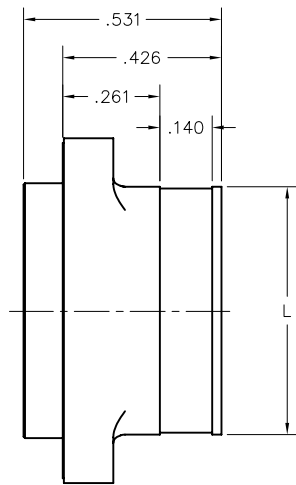
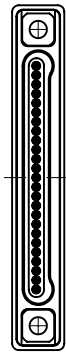

PLUG

DIMENSIONS					
SIZE	D	F	H	L	HARDWARE
9	.525	.140	.229	.265	#0-80
15	.675		.379	.415	
21	.825		.529	.565	
25	.925		.629	.665	
31	1.075		.779	.815	
37	1.225		.929	.965	
51	1.575	1.279	1.315		

THESE BACKSHELLS ARE AVAILABLE FACTORY INSTALLED ONLY. SEE PAGE N-10

1 · ROW Dust Cover

ND

Size 9 thru 51

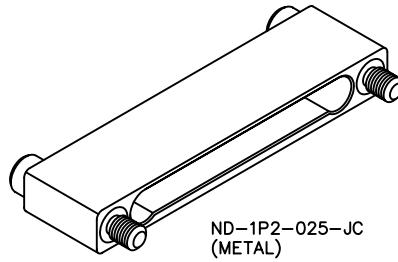

ND-1P2-025-JC
(METAL)

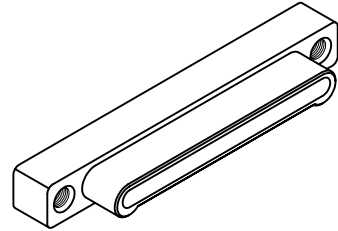

ND-1R2-025-TH
(METAL)

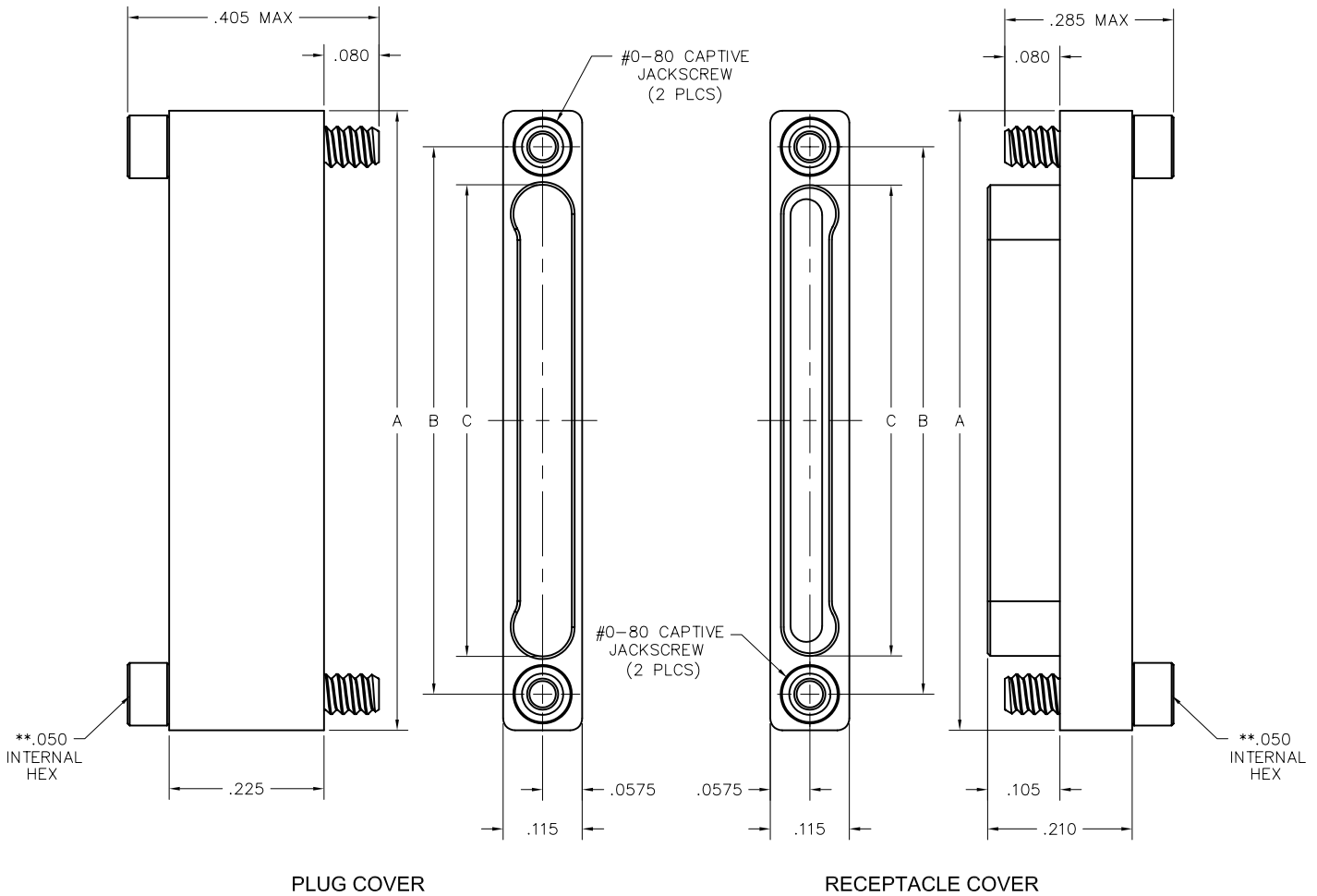

SIZE	DIMENSIONS			
	A	B	C	
			PLUG	RCPT
9	.500	.395	.285	.284
15	.650	.545	.435	.434
21	.800	.695	.585	.584
25	.900	.795	.685	.684
31	1.050	.945	.835	.834
37	1.200	1.095	.985	.984
51	1.550	1.445	1.335	1.334

** = HEX MEASUREMENT TAKEN ACROSS THE FLATS.

PLUG COVER: ND-1P2-009-JC
RECEPTACLE COVER: ND-1R2-009-TH
 XX-XXX-XXX-XX

PLUG COVER		RECEPTACLE COVER	
SERIES			
ND .025" Metal Dust Cover		ND .025" Metal Dust Cover	
BODY			
1	1-Row	1	1-Row
BODY STYLE: P Plug cover		BODY STYLE: R Receptacle cover	
BODY PLATING: 2 Electroless nickel 3 Electrodeposited cadmium <input checked="" type="checkbox"/>		BODY PLATING: 2 Electroless nickel 3 Electrodeposited cadmium <input checked="" type="checkbox"/>	
SIZE			
XXX 009, 015, 021, 025, 031, 037 or 051		XXX 009, 015, 021, 025, 031, 037 or 051	
HARDWARE			
STYLE OF HARDWARE: JC Turning jackscrews, captivated #0-80 UNF* TH Threaded hole, #0-80 UNF		STYLE OF HARDWARE: JC Turning jackscrews, captivated #0-80 UNF* TH Threaded hole, #0-80 UNF	

* = Recommended torque value 1.0 inch-lbs. max.
 Ball end hex wrench not recommended
 Hex wrench key/bit conforming to the requirements of ASME / ANSI-B-18.3 is recommended.
 .050" hex L-key long arm wrench - order AirBorn p/n CDG14148.

= Option not RoHS compliant

2 · ROW Dust Cover

ND

Size 9 thru 85

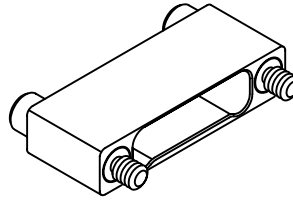

ND-2P2-025-JC
(METAL)

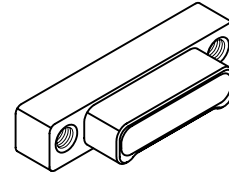

ND-2R2-025-TH
(METAL)

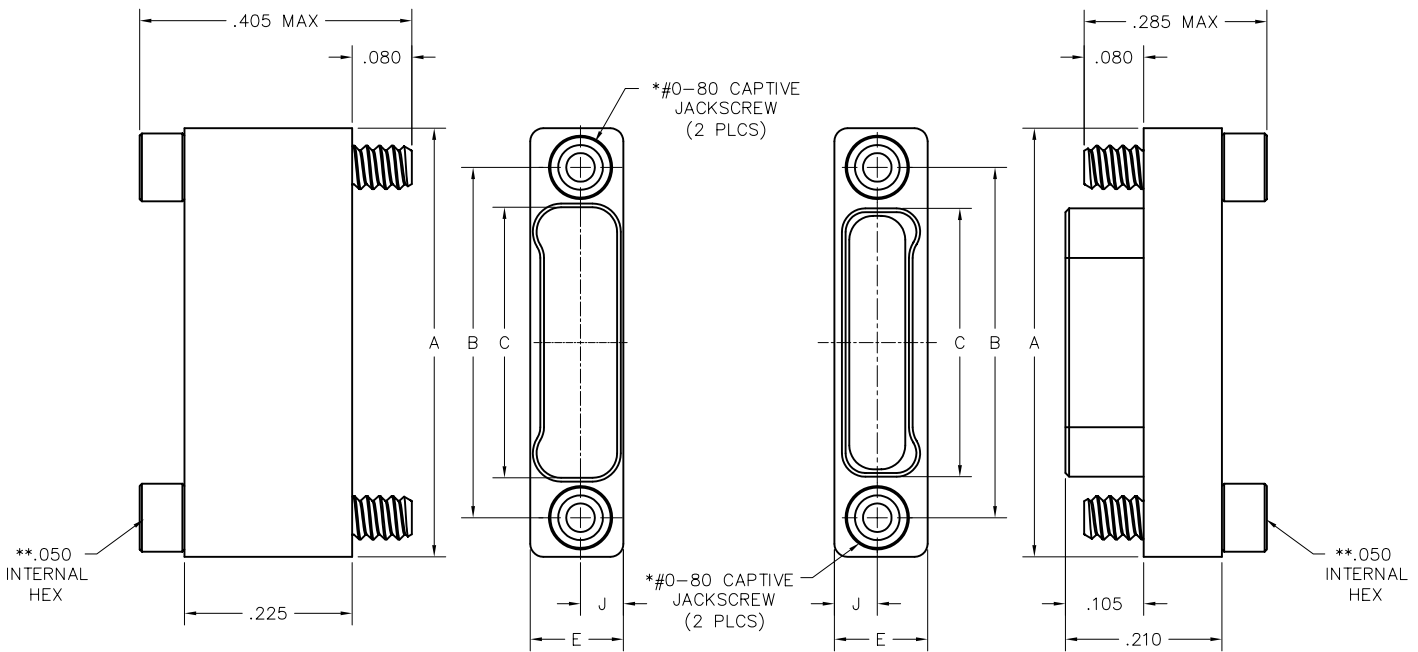

PLUG COVER

RECEPTACLE COVER

SIZE	DIMENSIONS						
	A	B	C		E	J	*HARDWARE
			PLUG	RCPT			
9	.375	.270	.163	.160			
15	.450	.345	.238	.235			
21	.525	.420	.313	.310			
25	.575	.470	.363	.360			
31	.650	.545	.438	.435	.125	.0575	#0-80 THREAD
37	.725	.620	.513	.510			
51	.900	.795	.688	.685			
65	1.075	.970	.863	.860			
69	1.125	1.020	.913	.910			
85	1.377	1.246	1.113	1.110	.150	.0700	#2-56 THREAD

* = #2-56 UNC THREAD ON 85 POSITION CONNECTORS.
 ** = 1/16" HEX ON 85 POSITION CONNECTORS. HEX MEASUREMENTS
 TAKEN ACROSS THE FLATS.

PLUG COVER: ND-2P2-009-JC
RECEPTACLE COVER: ND-2R2-009-TH
 XX-XXX-XXX-XX

PLUG COVER		RECEPTACLE COVER	
SERIES			
ND .025" Metal Dust Cover		ND .025" Metal Dust Cover	
BODY			
2 2-Row		2 2-Row	
BODY STYLE: P Plug cover		BODY STYLE: R Receptacle cover	
BODY PLATING: 2 Electroless nickel 3 Electrodeposited cadmium <input checked="" type="checkbox"/>		BODY PLATING: 2 Electroless nickel 3 Electrodeposited cadmium <input checked="" type="checkbox"/>	
SIZE			
XXX 009, 015, 021, 025, 031, 037, 051, 065, 069 or 085		XXX 009, 015, 021, 025, 031, 037, 051, 065, 069 or 085	
HARDWARE			
STYLE OF HARDWARE: JC Turning jackscrews, captivated #0-80 UNF* TH Threaded hole, #0-80 UNF*		STYLE OF HARDWARE: JC Turning jackscrews, captivated #0-80 UNF* TH Threaded hole, #0-80 UNF*	

* = #2-56 UNC thread on 85 position covers
 .050 hex key (#0-80 thread)
 1/16" hex key (#2-56 thread)
 Recommended torque value 1.0 inch-lbs. max. (#0-80 thread)
 Recommended torque value 2.0 inch-lbs. max. (#2-56 thread)
 Ball end hex wrench not recommended
 Hex wrench key/bit conforming to the requirements of ASME / ANSI-B-18.3 is recommended.
 .050" hex L-key long arm wrench - order AirBorn p/n CDG14148.
 1/16" hex L-key long arm wrench - order AirBorn p/n CDG14160.

= Option not RoHS compliant



2 · ROW Shorting

.025"

NMSH

9 thru 85 Contacts

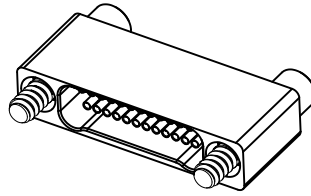

NMSH-222-025-225-JC00
(METAL)

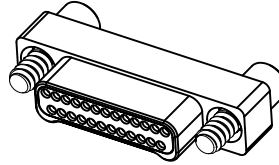

NMSH-212-025-125-JC00
(METAL)

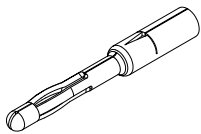
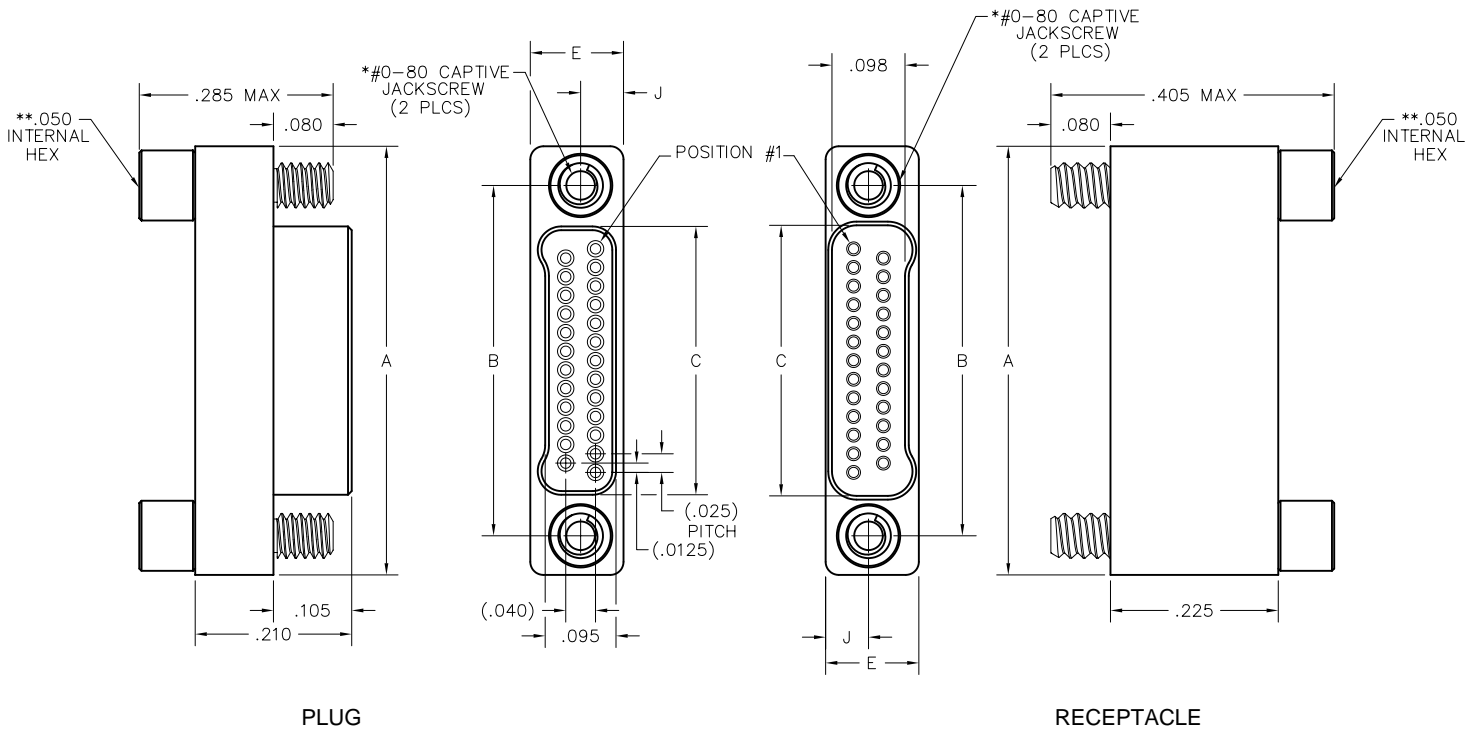

PIN CONTACT
3 TINE SPRING MEMBER, CRIMP

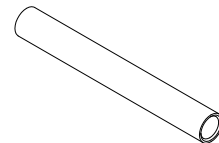

SOCKET CONTACT
DRAWN TUBE, CRIMP

SIZE	A	B	C		E	J	*HARDWARE
			PLUG	RCPT			
9	.375	.270	.160	.163	.125	.0575	#0-80 THREAD
15	.450	.345	.235	.238			
21	.525	.420	.310	.313			
25	.575	.470	.360	.363			
31	.650	.545	.435	.438			
37	.725	.620	.510	.513			
51	.900	.795	.685	.688			
65	1.075	.970	.860	.863			
69	1.125	1.020	.910	.913			
85	1.377	1.246	1.110	1.113			

* = #2-56 UNC THREAD ON 85 POSITION CONNECTORS.
 ** = 1/16" HEX ON 85 POSITION CONNECTORS. HEX MEASUREMENTS
 TAKEN ACROSS THE FLATS.



PLUG: NMSH-212-025-125-JC00
RECEPTACLE: NMSH-222-025-225-JC00
 XXXX-XXX-XXX-XXX-XXXX-XXX

PLUG	RECEPTACLE
SERIES	

NMSH .025" Metal I/O Connector	NMSH .025" Metal I/O Connector
--------------------------------	--------------------------------

BODY	
-------------	--

2 2-Row	2 2-Row
---------	---------

1 BODY STYLE: Plug, straight	2 BODY STYLE: Receptacle, straight
---------------------------------	---------------------------------------

2 BODY MATERIAL: Liquid Crystal Polymer w/ electroless nickel shell	2 BODY MATERIAL: Liquid Crystal Polymer w/ electroless nickel shell
3 Liquid Crystal Polymer w/ electrodeposited cadmium shell <input checked="" type="checkbox"/>	3 Liquid Crystal Polymer w/ electrodeposited cadmium shell <input checked="" type="checkbox"/>

SIZE	
-------------	--

XXX Number of contacts (009, 015, 021, 025, 031, 037, 051, 065, 069, or 085)	XXX Number of contacts (009, 015, 021, 025, 031, 037, 051, 065, 069, or 085)
--	--

CONTACTS	
-----------------	--

12 TYPE CONTACTS/TERMINATIONS: Pin, none	22 TYPE CONTACTS/TERMINATIONS: Socket, none
---	--

5 PLATING OPTIONS: 50 u" Au contacts, Sn/Pb alloy terminations <input checked="" type="checkbox"/>	5 PLATING OPTIONS: 50 u" Au contacts, Sn/Pb alloy terminations <input checked="" type="checkbox"/>
8 50 u" Au contacts, tin plated terminations	8 50 u" Au contacts, tin plated terminations

HARDWARE	
-----------------	--

JC STYLE OF HARDWARE: Turning jackscrews, captivated #0-80 UNF*	JC STYLE OF HARDWARE: Turning jackscrews, captivated #0-80 UNF*
TH Threaded hole, #0-80 UNF*	TH Threaded hole, #0-80 UNF*

00 WIRING OPTIONS: None, all contacts shorted together (not to shell)	00 WIRING OPTIONS: None, all contacts shorted together (not to shell)
--	--

OPTIONS	
----------------	--

yyy Selectively shorted contacts. Contact factory for modification code.	
--	--

* = #2-56 UNC thread on 85 position connectors
 .050 hex key (#0-80 thread)
 1/16" hex key (#2-56 thread)
 Recommended torque value 1.0 inch-lbs. max. (#0-80 thread)
 Recommended torque value 2.0 inch-lbs. max. (#2-56 thread)
 Ball end hex wrench not recommended
 Hex wrench key/bit conforming to the requirements of ASME / ANSI-B-18.3 is recommended.
 .050" hex L-key long arm wrench - order AirBorn p/n CDG14148.
 1/16" hex L-key long arm wrench - order AirBorn p/n CDG14160.

= Option not RoHS compliant

O-Rings, Fluorosilicone

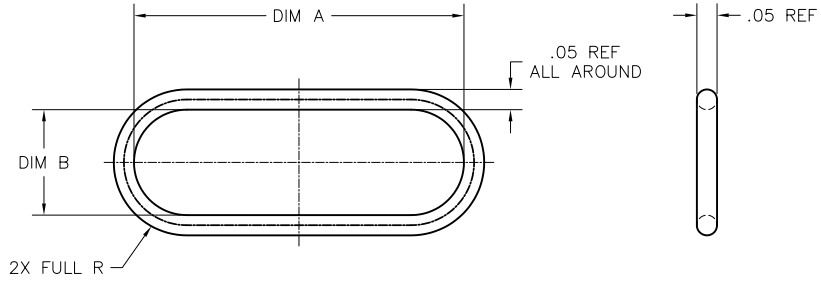

DIMENSIONS (Ref Only)			
SIZE	CONTACT ROWS	A	B
9	2	.73	.23
15		.81	
21		.88	
25		.93	
31		1.01	
37		1.08	
51		1.26	
65		1.43	
69	1.48		
85	2	1.73	.26

PART NUMBERS	
SIZE	P/N
9	CDP1980
15	CDP1981
21	CDP1982
25	CDP1983
31	CDP1984
37	CDP1985
51	CDP1986
65	CDP1987
69	CDP1988
85	CDP1989

EMI Gasket, Fluorosilicone

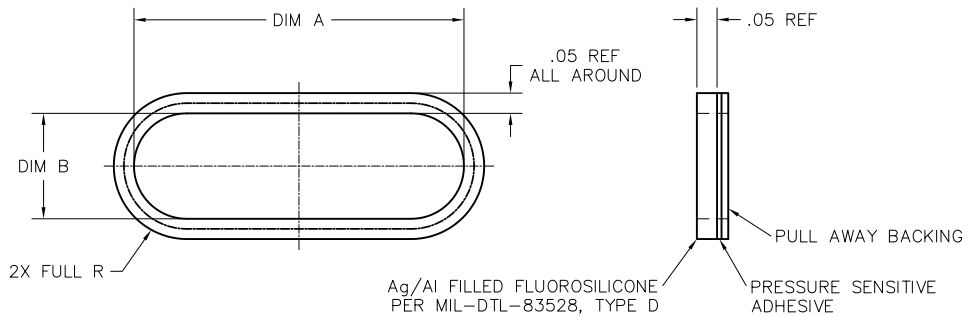

DIMENSIONS (Ref Only)			
SIZE	CONTACT ROWS	A	B
9	2	.74	.24
15		.81	
21		.89	
25		.94	
31		1.01	
37		1.09	
51		1.26	
65		1.44	
69	1.49		
85	2	1.74	.26

PART NUMBERS	
SIZE	P/N
9	CDP1990
15	CDP1991
21	CDP1992
25	CDP1993
31	CDP1994
37	CDP1995
51	CDP1996
65	CDP1997
69	CDP1998
85	CDP1999



Military Cross Reference Chart M32139/01

M32139/01- A01SC NM-113-009-161-JCAE B01SC NM-113-015-161-JCAE C01SC NM-113-021-161-JCAE D01SC NM-113-025-161-JCAE E01SC NM-113-031-161-JCAE F01SC NM-113-037-161-JCAE G01SC NM-113-051-161-JCAE	M32139/01- A01SN NM-112-009-161-JCAE B01SN NM-112-015-161-JCAE C01SN NM-112-021-161-JCAE D01SN NM-112-025-161-JCAE E01SN NM-112-031-161-JCAE F01SN NM-112-037-161-JCAE G01SN NM-112-051-161-JCAE	M32139/01- A01SS NM-114-009-161-JCAE B01SS NM-114-015-161-JCAE C01SS NM-114-021-161-JCAE D01SS NM-114-025-161-JCAE E01SS NM-114-031-161-JCAE F01SS NM-114-037-161-JCAE G01SS NM-114-051-161-JCAE	M32139/01- A01ST NM-115-009-161-JCAE B01ST NM-115-015-161-JCAE C01ST NM-115-021-161-JCAE D01ST NM-115-025-161-JCAE E01ST NM-115-031-161-JCAE F01ST NM-115-037-161-JCAE G01ST NM-115-051-161-JCAE
M32139/01- A02SC NM-113-009-161-JCAG B02SC NM-113-015-161-JCAG C02SC NM-113-021-161-JCAG D02SC NM-113-025-161-JCAG E02SC NM-113-031-161-JCAG F02SC NM-113-037-161-JCAG G02SC NM-113-051-161-JCAG	M32139/01- A02SN NM-112-009-161-JCAG B02SN NM-112-015-161-JCAG C02SN NM-112-021-161-JCAG D02SN NM-112-025-161-JCAG E02SN NM-112-031-161-JCAG F02SN NM-112-037-161-JCAG G02SN NM-112-051-161-JCAG	M32139/01- A02SS NM-114-009-161-JCAG B02SS NM-114-015-161-JCAG C02SS NM-114-021-161-JCAG D02SS NM-114-025-161-JCAG E02SS NM-114-031-161-JCAG F02SS NM-114-037-161-JCAG G02SS NM-114-051-161-JCAG	M32139/01- A02ST NM-115-009-161-JCAG B02ST NM-115-015-161-JCAG C02ST NM-115-021-161-JCAG D02ST NM-115-025-161-JCAG E02ST NM-115-031-161-JCAG F02ST NM-115-037-161-JCAG G02ST NM-115-051-161-JCAG
M32139/01- A03SC NM-113-009-161-JCAH B03SC NM-113-015-161-JCAH C03SC NM-113-021-161-JCAH D03SC NM-113-025-161-JCAH E03SC NM-113-031-161-JCAH F03SC NM-113-037-161-JCAH G03SC NM-113-051-161-JCAH	M32139/01- A03SN NM-112-009-161-JCAH B03SN NM-112-015-161-JCAH C03SN NM-112-021-161-JCAH D03SN NM-112-025-161-JCAH E03SN NM-112-031-161-JCAH F03SN NM-112-037-161-JCAH G03SN NM-112-051-161-JCAH	M32139/01- A03SS NM-114-009-161-JCAH B03SS NM-114-015-161-JCAH C03SS NM-114-021-161-JCAH D03SS NM-114-025-161-JCAH E03SS NM-114-031-161-JCAH F03SS NM-114-037-161-JCAH G03SS NM-114-051-161-JCAH	M32139/01- A03ST NM-115-009-161-JCAH B03ST NM-115-015-161-JCAH C03ST NM-115-021-161-JCAH D03ST NM-115-025-161-JCAH E03ST NM-115-031-161-JCAH F03ST NM-115-037-161-JCAH G03ST NM-115-051-161-JCAH
M32139/01- A04SC NM-113-009-161-JCAA B04SC NM-113-015-161-JCAA C04SC NM-113-021-161-JCAA D04SC NM-113-025-161-JCAA E04SC NM-113-031-161-JCAA F04SC NM-113-037-161-JCAA G04SC NM-113-051-161-JCAA	M32139/01- A04SN NM-112-009-161-JCAA B04SN NM-112-015-161-JCAA C04SN NM-112-021-161-JCAA D04SN NM-112-025-161-JCAA E04SN NM-112-031-161-JCAA F04SN NM-112-037-161-JCAA G04SN NM-112-051-161-JCAA	M32139/01- A04SS NM-114-009-161-JCAA B04SS NM-114-015-161-JCAA C04SS NM-114-021-161-JCAA D04SS NM-114-025-161-JCAA E04SS NM-114-031-161-JCAA F04SS NM-114-037-161-JCAA G04SS NM-114-051-161-JCAA	M32139/01- A04ST NM-115-009-161-JCAA B04ST NM-115-015-161-JCAA C04ST NM-115-021-161-JCAA D04ST NM-115-025-161-JCAA E04ST NM-115-031-161-JCAA F04ST NM-115-037-161-JCAA G04ST NM-115-051-161-JCAA
M32139/01- A05SC NM-113-009-161-JCAC B05SC NM-113-015-161-JCAC C05SC NM-113-021-161-JCAC D05SC NM-113-025-161-JCAC E05SC NM-113-031-161-JCAC F05SC NM-113-037-161-JCAC G05SC NM-113-051-161-JCAC	M32139/01- A05SN NM-112-009-161-JCAC B05SN NM-112-015-161-JCAC C05SN NM-112-021-161-JCAC D05SN NM-112-025-161-JCAC E05SN NM-112-031-161-JCAC F05SN NM-112-037-161-JCAC G05SN NM-112-051-161-JCAC	M32139/01- A05SS NM-114-009-161-JCAC B05SS NM-114-015-161-JCAC C05SS NM-114-021-161-JCAC D05SS NM-114-025-161-JCAC E05SS NM-114-031-161-JCAC F05SS NM-114-037-161-JCAC G05SS NM-114-051-161-JCAC	M32139/01- A05ST NM-115-009-161-JCAC B05ST NM-115-015-161-JCAC C05ST NM-115-021-161-JCAC D05ST NM-115-025-161-JCAC E05ST NM-115-031-161-JCAC F05ST NM-115-037-161-JCAC G05ST NM-115-051-161-JCAC
M32139/01- A06SC NM-113-009-161-JCAD B06SC NM-113-015-161-JCAD C06SC NM-113-021-161-JCAD D06SC NM-113-025-161-JCAD E06SC NM-113-031-161-JCAD F06SC NM-113-037-161-JCAD G06SC NM-113-051-161-JCAD	M32139/01- A06SN NM-112-009-161-JCAD B06SN NM-112-015-161-JCAD C06SN NM-112-021-161-JCAD D06SN NM-112-025-161-JCAD E06SN NM-112-031-161-JCAD F06SN NM-112-037-161-JCAD G06SN NM-112-051-161-JCAD	M32139/01- A06SS NM-114-009-161-JCAD B06SS NM-114-015-161-JCAD C06SS NM-114-021-161-JCAD D06SS NM-114-025-161-JCAD E06SS NM-114-031-161-JCAD F06SS NM-114-037-161-JCAD G06SS NM-114-051-161-JCAD	M32139/01- A06ST NM-115-009-161-JCAD B06ST NM-115-015-161-JCAD C06ST NM-115-021-161-JCAD D06ST NM-115-025-161-JCAD E06ST NM-115-031-161-JCAD F06ST NM-115-037-161-JCAD G06ST NM-115-051-161-JCAD

-- Continued on next page

SPACE CLASS DESIGNATOR - (S)

Cadmium Plated Aluminum shells are not available with the Space Class Designator; Space Class is optional on Nickel Plated Aluminum, Stainless Steel and Titanium Shells with SAE-AS22759/33 wire. AirBorn part numbers remain the same with or without the Designator.

Military Cross Reference Chart M32139/01

-- Continued from previous page

M32139/01- A07SC NM-113-009-161-JCBE B07SC NM-113-015-161-JCBE C07SC NM-113-021-161-JCBE D07SC NM-113-025-161-JCBE E07SC NM-113-031-161-JCBE F07SC NM-113-037-161-JCBE G07SC NM-113-051-161-JCBE	M32139/01- A07SN(S) NM-112-009-161-JCBE B07SN(S) NM-112-015-161-JCBE C07SN(S) NM-112-021-161-JCBE D07SN(S) NM-112-025-161-JCBE E07SN(S) NM-112-031-161-JCBE F07SN(S) NM-112-037-161-JCBE G07SN(S) NM-112-051-161-JCBE	M32139/01- A07SS(S) NM-114-009-161-JCBE B07SS(S) NM-114-015-161-JCBE C07SS(S) NM-114-021-161-JCBE D07SS(S) NM-114-025-161-JCBE E07SS(S) NM-114-031-161-JCBE F07SS(S) NM-114-037-161-JCBE G07SS(S) NM-114-051-161-JCBE	M32139/01- A07ST(S) NM-115-009-161-JCBE B07ST(S) NM-115-015-161-JCBE C07ST(S) NM-115-021-161-JCBE D07ST(S) NM-115-025-161-JCBE E07ST(S) NM-115-031-161-JCBE F07ST(S) NM-115-037-161-JCBE G07ST(S) NM-115-051-161-JCBE
M32139/01- A08SC NM-113-009-161-JCBG B08SC NM-113-015-161-JCBG C08SC NM-113-021-161-JCBG D08SC NM-113-025-161-JCBG E08SC NM-113-031-161-JCBG F08SC NM-113-037-161-JCBG G08SC NM-113-051-161-JCBG	M32139/01- A08SN(S) NM-112-009-161-JCBG B08SN(S) NM-112-015-161-JCBG C08SN(S) NM-112-021-161-JCBG D08SN(S) NM-112-025-161-JCBG E08SN(S) NM-112-031-161-JCBG F08SN(S) NM-112-037-161-JCBG G08SN(S) NM-112-051-161-JCBG	M32139/01- A08SS(S) NM-114-009-161-JCBG B08SS(S) NM-114-015-161-JCBG C08SS(S) NM-114-021-161-JCBG D08SS(S) NM-114-025-161-JCBG E08SS(S) NM-114-031-161-JCBG F08SS(S) NM-114-037-161-JCBG G08SS(S) NM-114-051-161-JCBG	M32139/01- A08ST(S) NM-115-009-161-JCBG B08ST(S) NM-115-015-161-JCBG C08ST(S) NM-115-021-161-JCBG D08ST(S) NM-115-025-161-JCBG E08ST(S) NM-115-031-161-JCBG F08ST(S) NM-115-037-161-JCBG G08ST(S) NM-115-051-161-JCBG
M32139/01- A09SC NM-113-009-161-JCBH B09SC NM-113-015-161-JCBH C09SC NM-113-021-161-JCBH D09SC NM-113-025-161-JCBH E09SC NM-113-031-161-JCBH F09SC NM-113-037-161-JCBH G09SC NM-113-051-161-JCBH	M32139/01- A09SN(S) NM-112-009-161-JCBH B09SN(S) NM-112-015-161-JCBH C09SN(S) NM-112-021-161-JCBH D09SN(S) NM-112-025-161-JCBH E09SN(S) NM-112-031-161-JCBH F09SN(S) NM-112-037-161-JCBH G09SN(S) NM-112-051-161-JCBH	M32139/01- A09SS(S) NM-114-009-161-JCBH B09SS(S) NM-114-015-161-JCBH C09SS(S) NM-114-021-161-JCBH D09SS(S) NM-114-025-161-JCBH E09SS(S) NM-114-031-161-JCBH F09SS(S) NM-114-037-161-JCBH G09SS(S) NM-114-051-161-JCBH	M32139/01- A09ST(S) NM-115-009-161-JCBH B09ST(S) NM-115-015-161-JCBH C09ST(S) NM-115-021-161-JCBH D09ST(S) NM-115-025-161-JCBH E09ST(S) NM-115-031-161-JCBH F09ST(S) NM-115-037-161-JCBH G09ST(S) NM-115-051-161-JCBH
M32139/01- A10SC NM-113-009-161-JCBA B10SC NM-113-015-161-JCBA C10SC NM-113-021-161-JCBA D10SC NM-113-025-161-JCBA E10SC NM-113-031-161-JCBA F10SC NM-113-037-161-JCBA G10SC NM-113-051-161-JCBA	M32139/01- A10SN(S) NM-112-009-161-JCBA B10SN(S) NM-112-015-161-JCBA C10SN(S) NM-112-021-161-JCBA D10SN(S) NM-112-025-161-JCBA E10SN(S) NM-112-031-161-JCBA F10SN(S) NM-112-037-161-JCBA G10SN(S) NM-112-051-161-JCBA	M32139/01- A10SS(S) NM-114-009-161-JCBA B10SS(S) NM-114-015-161-JCBA C10SS(S) NM-114-021-161-JCBA D10SS(S) NM-114-025-161-JCBA E10SS(S) NM-114-031-161-JCBA F10SS(S) NM-114-037-161-JCBA G10SS(S) NM-114-051-161-JCBA	M32139/01- A10ST(S) NM-115-009-161-JCBA B10ST(S) NM-115-015-161-JCBA C10ST(S) NM-115-021-161-JCBA D10ST(S) NM-115-025-161-JCBA E10ST(S) NM-115-031-161-JCBA F10ST(S) NM-115-037-161-JCBA G10ST(S) NM-115-051-161-JCBA
M32139/01- A11SC NM-113-009-161-JCBC B11SC NM-113-015-161-JCBC C11SC NM-113-021-161-JCBC D11SC NM-113-025-161-JCBC E11SC NM-113-031-161-JCBC F11SC NM-113-037-161-JCBC G11SC NM-113-051-161-JCBC	M32139/01- A11SN(S) NM-112-009-161-JCBC B11SN(S) NM-112-015-161-JCBC C11SN(S) NM-112-021-161-JCBC D11SN(S) NM-112-025-161-JCBC E11SN(S) NM-112-031-161-JCBC F11SN(S) NM-112-037-161-JCBC G11SN(S) NM-112-051-161-JCBC	M32139/01- A11SS(S) NM-114-009-161-JCBC B11SS(S) NM-114-015-161-JCBC C11SS(S) NM-114-021-161-JCBC D11SS(S) NM-114-025-161-JCBC E11SS(S) NM-114-031-161-JCBC F11SS(S) NM-114-037-161-JCBC G11SS(S) NM-114-051-161-JCBC	M32139/01- A11ST(S) NM-115-009-161-JCBC B11ST(S) NM-115-015-161-JCBC C11ST(S) NM-115-021-161-JCBC D11ST(S) NM-115-025-161-JCBC E11ST(S) NM-115-031-161-JCBC F11ST(S) NM-115-037-161-JCBC G11ST(S) NM-115-051-161-JCBC
M32139/01- A12SC NM-113-009-161-JCBD B12SC NM-113-015-161-JCBD C12SC NM-113-021-161-JCBD D12SC NM-113-025-161-JCBD E12SC NM-113-031-161-JCBD F12SC NM-113-037-161-JCBD G12SC NM-113-051-161-JCBD	M32139/01- A12SN(S) NM-112-009-161-JCBD B12SN(S) NM-112-015-161-JCBD C12SN(S) NM-112-021-161-JCBD D12SN(S) NM-112-025-161-JCBD E12SN(S) NM-112-031-161-JCBD F12SN(S) NM-112-037-161-JCBD G12SN(S) NM-112-051-161-JCBD	M32139/01- A12SS(S) NM-114-009-161-JCBD B12SS(S) NM-114-015-161-JCBD C12SS(S) NM-114-021-161-JCBD D12SS(S) NM-114-025-161-JCBD E12SS(S) NM-114-031-161-JCBD F12SS(S) NM-114-037-161-JCBD G12SS(S) NM-114-051-161-JCBD	M32139/01- A12ST(S) NM-115-009-161-JCBD B12ST(S) NM-115-015-161-JCBD C12ST(S) NM-115-021-161-JCBD D12ST(S) NM-115-025-161-JCBD E12ST(S) NM-115-031-161-JCBD F12ST(S) NM-115-037-161-JCBD G12ST(S) NM-115-051-161-JCBD

-- Continued on next page

SPACE CLASS DESIGNATOR - (S)

Cadmium Plated Aluminum shells are not available with the Space Class Designator; Space Class is optional on Nickel Plated Aluminum, Stainless Steel and Titanium Shells with SAE-AS22759/33 wire. AirBorn part numbers remain the same with or without the Designator.



Military Cross Reference Chart

M32139/01

-- Continued from previous page

M32139/01- A13SC NM-113-009-161-JCCE B13SC NM-113-015-161-JCCE C13SC NM-113-021-161-JCCE D13SC NM-113-025-161-JCCE E13SC NM-113-031-161-JCCE F13SC NM-113-037-161-JCCE G13SC NM-113-051-161-JCCE	M32139/01- A13SN NM-112-009-161-JCCE B13SN NM-112-015-161-JCCE C13SN NM-112-021-161-JCCE D13SN NM-112-025-161-JCCE E13SN NM-112-031-161-JCCE F13SN NM-112-037-161-JCCE G13SN NM-112-051-161-JCCE	M32139/01- A13SS NM-114-009-161-JCCE B13SS NM-114-015-161-JCCE C13SS NM-114-021-161-JCCE D13SS NM-114-025-161-JCCE E13SS NM-114-031-161-JCCE F13SS NM-114-037-161-JCCE G13SS NM-114-051-161-JCCE	M32139/01- A13ST NM-115-009-161-JCCE B13ST NM-115-015-161-JCCE C13ST NM-115-021-161-JCCE D13ST NM-115-025-161-JCCE E13ST NM-115-031-161-JCCE F13ST NM-115-037-161-JCCE G13ST NM-115-051-161-JCCE
M32139/01- A14SC NM-113-009-161-JCCG B14SC NM-113-015-161-JCCG C14SC NM-113-021-161-JCCG D14SC NM-113-025-161-JCCG E14SC NM-113-031-161-JCCG F14SC NM-113-037-161-JCCG G14SC NM-113-051-161-JCCG	M32139/01- A14SN NM-112-009-161-JCCG B14SN NM-112-015-161-JCCG C14SN NM-112-021-161-JCCG D14SN NM-112-025-161-JCCG E14SN NM-112-031-161-JCCG F14SN NM-112-037-161-JCCG G14SN NM-112-051-161-JCCG	M32139/01- A14SS NM-114-009-161-JCCG B14SS NM-114-015-161-JCCG C14SS NM-114-021-161-JCCG D14SS NM-114-025-161-JCCG E14SS NM-114-031-161-JCCG F14SS NM-114-037-161-JCCG G14SS NM-114-051-161-JCCG	M32139/01- A14ST NM-115-009-161-JCCG B14ST NM-115-015-161-JCCG C14ST NM-115-021-161-JCCG D14ST NM-115-025-161-JCCG E14ST NM-115-031-161-JCCG F14ST NM-115-037-161-JCCG G14ST NM-115-051-161-JCCG
M32139/01- A15SC NM-113-009-161-JCCH B15SC NM-113-015-161-JCCH C15SC NM-113-021-161-JCCH D15SC NM-113-025-161-JCCH E15SC NM-113-031-161-JCCH F15SC NM-113-037-161-JCCH G15SC NM-113-051-161-JCCH	M32139/01- A15SN NM-112-009-161-JCCH B15SN NM-112-015-161-JCCH C15SN NM-112-021-161-JCCH D15SN NM-112-025-161-JCCH E15SN NM-112-031-161-JCCH F15SN NM-112-037-161-JCCH G15SN NM-112-051-161-JCCH	M32139/01- A15SS NM-114-009-161-JCCH B15SS NM-114-015-161-JCCH C15SS NM-114-021-161-JCCH D15SS NM-114-025-161-JCCH E15SS NM-114-031-161-JCCH F15SS NM-114-037-161-JCCH G15SS NM-114-051-161-JCCH	M32139/01- A15ST NM-115-009-161-JCCH B15ST NM-115-015-161-JCCH C15ST NM-115-021-161-JCCH D15ST NM-115-025-161-JCCH E15ST NM-115-031-161-JCCH F15ST NM-115-037-161-JCCH G15ST NM-115-051-161-JCCH
M32139/01- A16SC NM-113-009-161-JCCA B16SC NM-113-015-161-JCCA C16SC NM-113-021-161-JCCA D16SC NM-113-025-161-JCCA E16SC NM-113-031-161-JCCA F16SC NM-113-037-161-JCCA G16SC NM-113-051-161-JCCA	M32139/01- A16SN NM-112-009-161-JCCA B16SN NM-112-015-161-JCCA C16SN NM-112-021-161-JCCA D16SN NM-112-025-161-JCCA E16SN NM-112-031-161-JCCA F16SN NM-112-037-161-JCCA G16SN NM-112-051-161-JCCA	M32139/01- A16SS NM-114-009-161-JCCA B16SS NM-114-015-161-JCCA C16SS NM-114-021-161-JCCA D16SS NM-114-025-161-JCCA E16SS NM-114-031-161-JCCA F16SS NM-114-037-161-JCCA G16SS NM-114-051-161-JCCA	M32139/01- A16ST NM-115-009-161-JCCA B16ST NM-115-015-161-JCCA C16ST NM-115-021-161-JCCA D16ST NM-115-025-161-JCCA E16ST NM-115-031-161-JCCA F16ST NM-115-037-161-JCCA G16ST NM-115-051-161-JCCA
M32139/01- A17SC NM-113-009-161-JCCC B17SC NM-113-015-161-JCCC C17SC NM-113-021-161-JCCC D17SC NM-113-025-161-JCCC E17SC NM-113-031-161-JCCC F17SC NM-113-037-161-JCCC G17SC NM-113-051-161-JCCC	M32139/01- A17SN NM-112-009-161-JCCC B17SN NM-112-015-161-JCCC C17SN NM-112-021-161-JCCC D17SN NM-112-025-161-JCCC E17SN NM-112-031-161-JCCC F17SN NM-112-037-161-JCCC G17SN NM-112-051-161-JCCC	M32139/01- A17SS NM-114-009-161-JCCC B17SS NM-114-015-161-JCCC C17SS NM-114-021-161-JCCC D17SS NM-114-025-161-JCCC E17SS NM-114-031-161-JCCC F17SS NM-114-037-161-JCCC G17SS NM-114-051-161-JCCC	M32139/01- A17ST NM-115-009-161-JCCC B17ST NM-115-015-161-JCCC C17ST NM-115-021-161-JCCC D17ST NM-115-025-161-JCCC E17ST NM-115-031-161-JCCC F17ST NM-115-037-161-JCCC G17ST NM-115-051-161-JCCC
M32139/01- A18SC NM-113-009-161-JCCD B18SC NM-113-015-161-JCCD C18SC NM-113-021-161-JCCD D18SC NM-113-025-161-JCCD E18SC NM-113-031-161-JCCD F18SC NM-113-037-161-JCCD G18SC NM-113-051-161-JCCD	M32139/01- A18SN NM-112-009-161-JCCD B18SN NM-112-015-161-JCCD C18SN NM-112-021-161-JCCD D18SN NM-112-025-161-JCCD E18SN NM-112-031-161-JCCD F18SN NM-112-037-161-JCCD G18SN NM-112-051-161-JCCD	M32139/01- A18SS NM-114-009-161-JCCD B18SS NM-114-015-161-JCCD C18SS NM-114-021-161-JCCD D18SS NM-114-025-161-JCCD E18SS NM-114-031-161-JCCD F18SS NM-114-037-161-JCCD G18SS NM-114-051-161-JCCD	M32139/01- A18ST NM-115-009-161-JCCD B18ST NM-115-015-161-JCCD C18ST NM-115-021-161-JCCD D18ST NM-115-025-161-JCCD E18ST NM-115-031-161-JCCD F18ST NM-115-037-161-JCCD G18ST NM-115-051-161-JCCD

-- Continued on next page

SPACE CLASS DESIGNATOR - (S)

Cadmium Plated Aluminum shells are not available with the Space Class Designator; Space Class is optional on Nickel Plated Aluminum, Stainless Steel and Titanium Shells with SAE-AS22759/33 wire. AirBorn part numbers remain the same with or without the Designator.

Military Cross Reference Chart M32139/02

-- Continued from previous page

M32139/02- A01TC NM-123-009-261-THAE B01TC NM-123-015-261-THAE C01TC NM-123-021-261-THAE D01TC NM-123-025-261-THAE E01TC NM-123-031-261-THAE F01TC NM-123-037-261-THAE G01TC NM-123-051-261-THAE	M32139/02- A01TN NM-122-009-261-THAE B01TN NM-122-015-261-THAE C01TN NM-122-021-261-THAE D01TN NM-122-025-261-THAE E01TN NM-122-031-261-THAE F01TN NM-122-037-261-THAE G01TN NM-122-051-261-THAE	M32139/02- A01TS NM-124-009-261-THAE B01TS NM-124-015-261-THAE C01TS NM-124-021-261-THAE D01TS NM-124-025-261-THAE E01TS NM-124-031-261-THAE F01TS NM-124-037-261-THAE G01TS NM-124-051-261-THAE	M32139/02- A01TT NM-125-009-261-THAE B01TT NM-125-015-261-THAE C01TT NM-125-021-261-THAE D01TT NM-125-025-261-THAE E01TT NM-125-031-261-THAE F01TT NM-125-037-261-THAE G01TT NM-125-051-261-THAE
M32139/02- A02TC NM-123-009-261-THAG B02TC NM-123-015-261-THAG C02TC NM-123-021-261-THAG D02TC NM-123-025-261-THAG E02TC NM-123-031-261-THAG F02TC NM-123-037-261-THAG G02TC NM-123-051-261-THAG	M32139/02- A02TN NM-122-009-261-THAG B02TN NM-122-015-261-THAG C02TN NM-122-021-261-THAG D02TN NM-122-025-261-THAG E02TN NM-122-031-261-THAG F02TN NM-122-037-261-THAG G02TN NM-122-051-261-THAG	M32139/02- A02TS NM-124-009-261-THAG B02TS NM-124-015-261-THAG C02TS NM-124-021-261-THAG D02TS NM-124-025-261-THAG E02TS NM-124-031-261-THAG F02TS NM-124-037-261-THAG G02TS NM-124-051-261-THAG	M32139/02- A02TT NM-125-009-261-THAG B02TT NM-125-015-261-THAG C02TT NM-125-021-261-THAG D02TT NM-125-025-261-THAG E02TT NM-125-031-261-THAG F02TT NM-125-037-261-THAG G02TT NM-125-051-261-THAG
M32139/02- A03TC NM-123-009-261-THAH B03TC NM-123-015-261-THAH C03TC NM-123-021-261-THAH D03TC NM-123-025-261-THAH E03TC NM-123-031-261-THAH F03TC NM-123-037-261-THAH G03TC NM-123-051-261-THAH	M32139/02- A03TN NM-122-009-261-THAH B03TN NM-122-015-261-THAH C03TN NM-122-021-261-THAH D03TN NM-122-025-261-THAH E03TN NM-122-031-261-THAH F03TN NM-122-037-261-THAH G03TN NM-122-051-261-THAH	M32139/02- A03TS NM-124-009-261-THAH B03TS NM-124-015-261-THAH C03TS NM-124-021-261-THAH D03TS NM-124-025-261-THAH E03TS NM-124-031-261-THAH F03TS NM-124-037-261-THAH G03TS NM-124-051-261-THAH	M32139/02- A03TT NM-125-009-261-THAH B03TT NM-125-015-261-THAH C03TT NM-125-021-261-THAH D03TT NM-125-025-261-THAH E03TT NM-125-031-261-THAH F03TT NM-125-037-261-THAH G03TT NM-125-051-261-THAH
M32139/02- A04TC NM-123-009-261-THAA B04TC NM-123-015-261-THAA C04TC NM-123-021-261-THAA D04TC NM-123-025-261-THAA E04TC NM-123-031-261-THAA F04TC NM-123-037-261-THAA G04TC NM-123-051-261-THAA	M32139/02- A04TN NM-122-009-261-THAA B04TN NM-122-015-261-THAA C04TN NM-122-021-261-THAA D04TN NM-122-025-261-THAA E04TN NM-122-031-261-THAA F04TN NM-122-037-261-THAA G04TN NM-122-051-261-THAA	M32139/02- A04TS NM-124-009-261-THAA B04TS NM-124-015-261-THAA C04TS NM-124-021-261-THAA D04TS NM-124-025-261-THAA E04TS NM-124-031-261-THAA F04TS NM-124-037-261-THAA G04TS NM-124-051-261-THAA	M32139/02- A04TT NM-125-009-261-THAA B04TT NM-125-015-261-THAA C04TT NM-125-021-261-THAA D04TT NM-125-025-261-THAA E04TT NM-125-031-261-THAA F04TT NM-125-037-261-THAA G04TT NM-125-051-261-THAA
M32139/02- A05TC NM-123-009-261-THAC B05TC NM-123-015-261-THAC C05TC NM-123-021-261-THAC D05TC NM-123-025-261-THAC E05TC NM-123-031-261-THAC F05TC NM-123-037-261-THAC G05TC NM-123-051-261-THAC	M32139/02- A05TN NM-122-009-261-THAC B05TN NM-122-015-261-THAC C05TN NM-122-021-261-THAC D05TN NM-122-025-261-THAC E05TN NM-122-031-261-THAC F05TN NM-122-037-261-THAC G05TN NM-122-051-261-THAC	M32139/02- A05TS NM-124-009-261-THAC B05TS NM-124-015-261-THAC C05TS NM-124-021-261-THAC D05TS NM-124-025-261-THAC E05TS NM-124-031-261-THAC F05TS NM-124-037-261-THAC G05TS NM-124-051-261-THAC	M32139/02- A05TT NM-125-009-261-THAC B05TT NM-125-015-261-THAC C05TT NM-125-021-261-THAC D05TT NM-125-025-261-THAC E05TT NM-125-031-261-THAC F05TT NM-125-037-261-THAC G05TT NM-125-051-261-THAC
M32139/02- A06TC NM-123-009-261-THAD B06TC NM-123-015-261-THAD C06TC NM-123-021-261-THAD D06TC NM-123-025-261-THAD E06TC NM-123-031-261-THAD F06TC NM-123-037-261-THAD G06TC NM-123-051-261-THAD	M32139/02- A06TN NM-122-009-261-THAD B06TN NM-122-015-261-THAD C06TN NM-122-021-261-THAD D06TN NM-122-025-261-THAD E06TN NM-122-031-261-THAD F06TN NM-122-037-261-THAD G06TN NM-122-051-261-THAD	M32139/02- A06TS NM-124-009-261-THAD B06TS NM-124-015-261-THAD C06TS NM-124-021-261-THAD D06TS NM-124-025-261-THAD E06TS NM-124-031-261-THAD F06TS NM-124-037-261-THAD G06TS NM-124-051-261-THAD	M32139/02- A06TT NM-125-009-261-THAD B06TT NM-125-015-261-THAD C06TT NM-125-021-261-THAD D06TT NM-125-025-261-THAD E06TT NM-125-031-261-THAD F06TT NM-125-037-261-THAD G06TT NM-125-051-261-THAD

-- Continued on next page

SPACE CLASS DESIGNATOR - (S)

Cadmium Plated Aluminum shells are not available with the Space Class Designator; Space Class is optional on Nickel Plated Aluminum, Stainless Steel and Titanium Shells with SAE-AS22759/33 wire. AirBorn part numbers remain the same with or without the Designator.



Military Cross Reference Chart

M32139/02

-- Continued from previous page

M32139/02- A07TC NM-123-009-261-THBE B07TC NM-123-015-261-THBE C07TC NM-123-021-261-THBE D07TC NM-123-025-261-THBE E07TC NM-123-031-261-THBE F07TC NM-123-037-261-THBE G07TC NM-123-051-261-THBE	M32139/02- A07TN(S) NM-122-009-261-THBE B07TN(S) NM-122-015-261-THBE C07TN(S) NM-122-021-261-THBE D07TN(S) NM-122-025-261-THBE E07TN(S) NM-122-031-261-THBE F07TN(S) NM-122-037-261-THBE G07TN(S) NM-122-051-261-THBE	M32139/02- A07TS(S) NM-124-009-261-THBE B07TS(S) NM-124-015-261-THBE C07TS(S) NM-124-021-261-THBE D07TS(S) NM-124-025-261-THBE E07TS(S) NM-124-031-261-THBE F07TS(S) NM-124-037-261-THBE G07TS(S) NM-124-051-261-THBE	M32139/02- A07TT(S) NM-125-009-261-THBE B07TT(S) NM-125-015-261-THBE C07TT(S) NM-125-021-261-THBE D07TT(S) NM-125-025-261-THBE E07TT(S) NM-125-031-261-THBE F07TT(S) NM-125-037-261-THBE G07TT(S) NM-125-051-261-THBE
M32139/02- A08TC NM-123-009-261-THBG B08TC NM-123-015-261-THBG C08TC NM-123-021-261-THBG D08TC NM-123-025-261-THBG E08TC NM-123-031-261-THBG F08TC NM-123-037-261-THBG G08TC NM-123-051-261-THBG	M32139/02- A08TN(S) NM-122-009-261-THBG B08TN(S) NM-122-015-261-THBG C08TN(S) NM-122-021-261-THBG D08TN(S) NM-122-025-261-THBG E08TN(S) NM-122-031-261-THBG F08TN(S) NM-122-037-261-THBG G08TN(S) NM-122-051-261-THBG	M32139/02- A08TS(S) NM-124-009-261-THBG B08TS(S) NM-124-015-261-THBG C08TS(S) NM-124-021-261-THBG D08TS(S) NM-124-025-261-THBG E08TS(S) NM-124-031-261-THBG F08TS(S) NM-124-037-261-THBG G08TS(S) NM-124-051-261-THBG	M32139/02- A08TT(S) NM-125-009-261-THBG B08TT(S) NM-125-015-261-THBG C08TT(S) NM-125-021-261-THBG D08TT(S) NM-125-025-261-THBG E08TT(S) NM-125-031-261-THBG F08TT(S) NM-125-037-261-THBG G08TT(S) NM-125-051-261-THBG
M32139/02- A09TC NM-123-009-261-THBH B09TC NM-123-015-261-THBH C09TC NM-123-021-261-THBH D09TC NM-123-025-261-THBH E09TC NM-123-031-261-THBH F09TC NM-123-037-261-THBH G09TC NM-123-051-261-THBH	M32139/02- A09TN(S) NM-122-009-261-THBH B09TN(S) NM-122-015-261-THBH C09TN(S) NM-122-021-261-THBH D09TN(S) NM-122-025-261-THBH E09TN(S) NM-122-031-261-THBH F09TN(S) NM-122-037-261-THBH G09TN(S) NM-122-051-261-THBH	M32139/02- A09TS(S) NM-124-009-261-THBH B09TS(S) NM-124-015-261-THBH C09TS(S) NM-124-021-261-THBH D09TS(S) NM-124-025-261-THBH E09TS(S) NM-124-031-261-THBH F09TS(S) NM-124-037-261-THBH G09TS(S) NM-124-051-261-THBH	M32139/02- A09TT(S) NM-125-009-261-THBH B09TT(S) NM-125-015-261-THBH C09TT(S) NM-125-021-261-THBH D09TT(S) NM-125-025-261-THBH E09TT(S) NM-125-031-261-THBH F09TT(S) NM-125-037-261-THBH G09TT(S) NM-125-051-261-THBH
M32139/02- A10TC NM-123-009-261-THBA B10TC NM-123-015-261-THBA C10TC NM-123-021-261-THBA D10TC NM-123-025-261-THBA E10TC NM-123-031-261-THBA F10TC NM-123-037-261-THBA G10TC NM-123-051-261-THBA	M32139/02- A10TN(S) NM-122-009-261-THBA B10TN(S) NM-122-015-261-THBA C10TN(S) NM-122-021-261-THBA D10TN(S) NM-122-025-261-THBA E10TN(S) NM-122-031-261-THBA F10TN(S) NM-122-037-261-THBA G10TN(S) NM-122-051-261-THBA	M32139/02- A10TS(S) NM-124-009-261-THBA B10TS(S) NM-124-015-261-THBA C10TS(S) NM-124-021-261-THBA D10TS(S) NM-124-025-261-THBA E10TS(S) NM-124-031-261-THBA F10TS(S) NM-124-037-261-THBA G10TS(S) NM-124-051-261-THBA	M32139/02- A10TT(S) NM-125-009-261-THBA B10TT(S) NM-125-015-261-THBA C10TT(S) NM-125-021-261-THBA D10TT(S) NM-125-025-261-THBA E10TT(S) NM-125-031-261-THBA F10TT(S) NM-125-037-261-THBA G10TT(S) NM-125-051-261-THBA
M32139/02- A11TC NM-123-009-261-THBC B11TC NM-123-015-261-THBC C11TC NM-123-021-261-THBC D11TC NM-123-025-261-THBC E11TC NM-123-031-261-THBC F11TC NM-123-037-261-THBC G11TC NM-123-051-261-THBC	M32139/02- A11TN(S) NM-122-009-261-THBC B11TN(S) NM-122-015-261-THBC C11TN(S) NM-122-021-261-THBC D11TN(S) NM-122-025-261-THBC E11TN(S) NM-122-031-261-THBC F11TN(S) NM-122-037-261-THBC G11TN(S) NM-122-051-261-THBC	M32139/02- A11TS(S) NM-124-009-261-THBC B11TS(S) NM-124-015-261-THBC C11TS(S) NM-124-021-261-THBC D11TS(S) NM-124-025-261-THBC E11TS(S) NM-124-031-261-THBC F11TS(S) NM-124-037-261-THBC G11TS(S) NM-124-051-261-THBC	M32139/02- A11TT(S) NM-125-009-261-THBC B11TT(S) NM-125-015-261-THBC C11TT(S) NM-125-021-261-THBC D11TT(S) NM-125-025-261-THBC E11TT(S) NM-125-031-261-THBC F11TT(S) NM-125-037-261-THBC G11TT(S) NM-125-051-261-THBC
M32139/02- A12TC NM-123-009-261-THBD B12TC NM-123-015-261-THBD C12TC NM-123-021-261-THBD D12TC NM-123-025-261-THBD E12TC NM-123-031-261-THBD F12TC NM-123-037-261-THBD G12TC NM-123-051-261-THBD	M32139/02- A12TN(S) NM-122-009-261-THBD B12TN(S) NM-122-015-261-THBD C12TN(S) NM-122-021-261-THBD D12TN(S) NM-122-025-261-THBD E12TN(S) NM-122-031-261-THBD F12TN(S) NM-122-037-261-THBD G12TN(S) NM-122-051-261-THBD	M32139/02- A12TS(S) NM-124-009-261-THBD B12TS(S) NM-124-015-261-THBD C12TS(S) NM-124-021-261-THBD D12TS(S) NM-124-025-261-THBD E12TS(S) NM-124-031-261-THBD F12TS(S) NM-124-037-261-THBD G12TS(S) NM-124-051-261-THBD	M32139/02- A12TT(S) NM-125-009-261-THBD B12TT(S) NM-125-015-261-THBD C12TT(S) NM-125-021-261-THBD D12TT(S) NM-125-025-261-THBD E12TT(S) NM-125-031-261-THBD F12TT(S) NM-125-037-261-THBD G12TT(S) NM-125-051-261-THBD

-- Continued on next page

SPACE CLASS DESIGNATOR - (S)

Cadmium Plated Aluminum shells are not available with the Space Class Designator; Space Class is optional on Nickel Plated Aluminum, Stainless Steel and Titanium Shells with SAE-AS22759/33 wire. AirBorn part numbers remain the same with or without the Designator.

Military Cross Reference Chart M32139/02

-- Continued from previous page

M32139/02- A13TC NM-123-009-261-THCE B13TC NM-123-015-261-THCE C13TC NM-123-021-261-THCE D13TC NM-123-025-261-THCE E13TC NM-123-031-261-THCE F13TC NM-123-037-261-THCE G13TC NM-123-051-261-THCE	M32139/02- A13TN NM-122-009-261-THCE B13TN NM-122-015-261-THCE C13TN NM-122-021-261-THCE D13TN NM-122-025-261-THCE E13TN NM-122-031-261-THCE F13TN NM-122-037-261-THCE G13TN NM-122-051-261-THCE	M32139/02- A13TS NM-124-009-261-THCE B13TS NM-124-015-261-THCE C13TS NM-124-021-261-THCE D13TS NM-124-025-261-THCE E13TS NM-124-031-261-THCE F13TS NM-124-037-261-THCE G13TS NM-124-051-261-THCE	M32139/02- A13TT NM-125-009-261-THCE B13TT NM-125-015-261-THCE C13TT NM-125-021-261-THCE D13TT NM-125-025-261-THCE E13TT NM-125-031-261-THCE F13TT NM-125-037-261-THCE G13TT NM-125-051-261-THCE
M32139/02- A14TC NM-123-009-261-THCG B14TC NM-123-015-261-THCG C14TC NM-123-021-261-THCG D14TC NM-123-025-261-THCG E14TC NM-123-031-261-THCG F14TC NM-123-037-261-THCG G14TC NM-123-051-261-THCG	M32139/02- A14TN NM-122-009-261-THCG B14TN NM-122-015-261-THCG C14TN NM-122-021-261-THCG D14TN NM-122-025-261-THCG E14TN NM-122-031-261-THCG F14TN NM-122-037-261-THCG G14TN NM-122-051-261-THCG	M32139/02- A14TS NM-124-009-261-THCG B14TS NM-124-015-261-THCG C14TS NM-124-021-261-THCG D14TS NM-124-025-261-THCG E14TS NM-124-031-261-THCG F14TS NM-124-037-261-THCG G14TS NM-124-051-261-THCG	M32139/02- A14TT NM-125-009-261-THCG B14TT NM-125-015-261-THCG C14TT NM-125-021-261-THCG D14TT NM-125-025-261-THCG E14TT NM-125-031-261-THCG F14TT NM-125-037-261-THCG G14TT NM-125-051-261-THCG
M32139/02- A15TC NM-123-009-261-THCH B15TC NM-123-015-261-THCH C15TC NM-123-021-261-THCH D15TC NM-123-025-261-THCH E15TC NM-123-031-261-THCH F15TC NM-123-037-261-THCH G15TC NM-123-051-261-THCH	M32139/02- A15TN NM-122-009-261-THCH B15TN NM-122-015-261-THCH C15TN NM-122-021-261-THCH D15TN NM-122-025-261-THCH E15TN NM-122-031-261-THCH F15TN NM-122-037-261-THCH G15TN NM-122-051-261-THCH	M32139/02- A15TS NM-124-009-261-THCH B15TS NM-124-015-261-THCH C15TS NM-124-021-261-THCH D15TS NM-124-025-261-THCH E15TS NM-124-031-261-THCH F15TS NM-124-037-261-THCH G15TS NM-124-051-261-THCH	M32139/02- A15TT NM-125-009-261-THCH B15TT NM-125-015-261-THCH C15TT NM-125-021-261-THCH D15TT NM-125-025-261-THCH E15TT NM-125-031-261-THCH F15TT NM-125-037-261-THCH G15TT NM-125-051-261-THCH
M32139/02- A16TC NM-123-009-261-THCA B16TC NM-123-015-261-THCA C16TC NM-123-021-261-THCA D16TC NM-123-025-261-THCA E16TC NM-123-031-261-THCA F16TC NM-123-037-261-THCA G16TC NM-123-051-261-THCA	M32139/02- A16TN NM-122-009-261-THCA B16TN NM-122-015-261-THCA C16TN NM-122-021-261-THCA D16TN NM-122-025-261-THCA E16TN NM-122-031-261-THCA F16TN NM-122-037-261-THCA G16TN NM-122-051-261-THCA	M32139/02- A16TS NM-124-009-261-THCA B16TS NM-124-015-261-THCA C16TS NM-124-021-261-THCA D16TS NM-124-025-261-THCA E16TS NM-124-031-261-THCA F16TS NM-124-037-261-THCA G16TS NM-124-051-261-THCA	M32139/02- A16TT NM-125-009-261-THCA B16TT NM-125-015-261-THCA C16TT NM-125-021-261-THCA D16TT NM-125-025-261-THCA E16TT NM-125-031-261-THCA F16TT NM-125-037-261-THCA G16TT NM-125-051-261-THCA
M32139/02- A17TC NM-123-009-261-THCC B17TC NM-123-015-261-THCC C17TC NM-123-021-261-THCC D17TC NM-123-025-261-THCC E17TC NM-123-031-261-THCC F17TC NM-123-037-261-THCC G17TC NM-123-051-261-THCC	M32139/02- A17TN NM-122-009-261-THCC B17TN NM-122-015-261-THCC C17TN NM-122-021-261-THCC D17TN NM-122-025-261-THCC E17TN NM-122-031-261-THCC F17TN NM-122-037-261-THCC G17TN NM-122-051-261-THCC	M32139/02- A17TS NM-124-009-261-THCC B17TS NM-124-015-261-THCC C17TS NM-124-021-261-THCC D17TS NM-124-025-261-THCC E17TS NM-124-031-261-THCC F17TS NM-124-037-261-THCC G17TS NM-124-051-261-THCC	M32139/02- A17TT NM-125-009-261-THCC B17TT NM-125-015-261-THCC C17TT NM-125-021-261-THCC D17TT NM-125-025-261-THCC E17TT NM-125-031-261-THCC F17TT NM-125-037-261-THCC G17TT NM-125-051-261-THCC
M32139/02- A18TC NM-123-009-261-THCD B18TC NM-123-015-261-THCD C18TC NM-123-021-261-THCD D18TC NM-123-025-261-THCD E18TC NM-123-031-261-THCD F18TC NM-123-037-261-THCD G18TC NM-123-051-261-THCD	M32139/02- A18TN NM-122-009-261-THCD B18TN NM-122-015-261-THCD C18TN NM-122-021-261-THCD D18TN NM-122-025-261-THCD E18TN NM-122-031-261-THCD F18TN NM-122-037-261-THCD G18TN NM-122-051-261-THCD	M32139/02- A18TS NM-124-009-261-THCD B18TS NM-124-015-261-THCD C18TS NM-124-021-261-THCD D18TS NM-124-025-261-THCD E18TS NM-124-031-261-THCD F18TS NM-124-037-261-THCD G18TS NM-124-051-261-THCD	M32139/02- A18TT NM-125-009-261-THCD B18TT NM-125-015-261-THCD C18TT NM-125-021-261-THCD D18TT NM-125-025-261-THCD E18TT NM-125-031-261-THCD F18TT NM-125-037-261-THCD G18TT NM-125-051-261-THCD

-- Continued on next page

SPACE CLASS DESIGNATOR - (S)

Cadmium Plated Aluminum shells are not available with the Space Class Designator; Space Class is optional on Nickel Plated Aluminum, Stainless Steel and Titanium Shells with SAE-AS22759/33 wire. AirBorn part numbers remain the same with or without the Designator.



Military Cross Reference Chart

M32139/03

-- Continued from previous page

M32139/03- A01SC NM-213-009-161-JCAE B01SC NM-213-015-161-JCAE C01SC NM-213-021-161-JCAE D01SC NM-213-025-161-JCAE E01SC NM-213-031-161-JCAE F01SC NM-213-037-161-JCAE G01SC NM-213-051-161-JCAE	M32139/03- A01SN NM-212-009-161-JCAE B01SN NM-212-015-161-JCAE C01SN NM-212-021-161-JCAE D01SN NM-212-025-161-JCAE E01SN NM-212-031-161-JCAE F01SN NM-212-037-161-JCAE G01SN NM-212-051-161-JCAE	M32139/03- A01SS NM-214-009-161-JCAE B01SS NM-214-015-161-JCAE C01SS NM-214-021-161-JCAE D01SS NM-214-025-161-JCAE E01SS NM-214-031-161-JCAE F01SS NM-214-037-161-JCAE G01SS NM-214-051-161-JCAE	M32139/03- A01ST NM-215-009-161-JCAE B01ST NM-215-015-161-JCAE C01ST NM-215-021-161-JCAE D01ST NM-215-025-161-JCAE E01ST NM-215-031-161-JCAE F01ST NM-215-037-161-JCAE G01ST NM-215-051-161-JCAE
M32139/03- A02SC NM-213-009-161-JCAG B02SC NM-213-015-161-JCAG C02SC NM-213-021-161-JCAG D02SC NM-213-025-161-JCAG E02SC NM-213-031-161-JCAG F02SC NM-213-037-161-JCAG G02SC NM-213-051-161-JCAG	M32139/03- A02SN NM-212-009-161-JCAG B02SN NM-212-015-161-JCAG C02SN NM-212-021-161-JCAG D02SN NM-212-025-161-JCAG E02SN NM-212-031-161-JCAG F02SN NM-212-037-161-JCAG G02SN NM-212-051-161-JCAG	M32139/03- A02SS NM-214-009-161-JCAG B02SS NM-214-015-161-JCAG C02SS NM-214-021-161-JCAG D02SS NM-214-025-161-JCAG E02SS NM-214-031-161-JCAG F02SS NM-214-037-161-JCAG G02SS NM-214-051-161-JCAG	M32139/03- A02ST NM-215-009-161-JCAG B02ST NM-215-015-161-JCAG C02ST NM-215-021-161-JCAG D02ST NM-215-025-161-JCAG E02ST NM-215-031-161-JCAG F02ST NM-215-037-161-JCAG G02ST NM-215-051-161-JCAG
M32139/03- A03SC NM-213-009-161-JCAH B03SC NM-213-015-161-JCAH C03SC NM-213-021-161-JCAH D03SC NM-213-025-161-JCAH E03SC NM-213-031-161-JCAH F03SC NM-213-037-161-JCAH G03SC NM-213-051-161-JCAH	M32139/03- A03SN NM-212-009-161-JCAH B03SN NM-212-015-161-JCAH C03SN NM-212-021-161-JCAH D03SN NM-212-025-161-JCAH E03SN NM-212-031-161-JCAH F03SN NM-212-037-161-JCAH G03SN NM-212-051-161-JCAH	M32139/03- A03SS NM-214-009-161-JCAH B03SS NM-214-015-161-JCAH C03SS NM-214-021-161-JCAH D03SS NM-214-025-161-JCAH E03SS NM-214-031-161-JCAH F03SS NM-214-037-161-JCAH G03SS NM-214-051-161-JCAH	M32139/03- A03ST NM-215-009-161-JCAH B03ST NM-215-015-161-JCAH C03ST NM-215-021-161-JCAH D03ST NM-215-025-161-JCAH E03ST NM-215-031-161-JCAH F03ST NM-215-037-161-JCAH G03ST NM-215-051-161-JCAH
M32139/03- A04SC NM-213-009-161-JCAA B04SC NM-213-015-161-JCAA C04SC NM-213-021-161-JCAA D04SC NM-213-025-161-JCAA E04SC NM-213-031-161-JCAA F04SC NM-213-037-161-JCAA G04SC NM-213-051-161-JCAA	M32139/03- A04SN NM-212-009-161-JCAA B04SN NM-212-015-161-JCAA C04SN NM-212-021-161-JCAA D04SN NM-212-025-161-JCAA E04SN NM-212-031-161-JCAA F04SN NM-212-037-161-JCAA G04SN NM-212-051-161-JCAA	M32139/03- A04SS NM-214-009-161-JCAA B04SS NM-214-015-161-JCAA C04SS NM-214-021-161-JCAA D04SS NM-214-025-161-JCAA E04SS NM-214-031-161-JCAA F04SS NM-214-037-161-JCAA G04SS NM-214-051-161-JCAA	M32139/03- A04ST NM-215-009-161-JCAA B04ST NM-215-015-161-JCAA C04ST NM-215-021-161-JCAA D04ST NM-215-025-161-JCAA E04ST NM-215-031-161-JCAA F04ST NM-215-037-161-JCAA G04ST NM-215-051-161-JCAA
M32139/03- A05SC NM-213-009-161-JCAC B05SC NM-213-015-161-JCAC C05SC NM-213-021-161-JCAC D05SC NM-213-025-161-JCAC E05SC NM-213-031-161-JCAC F05SC NM-213-037-161-JCAC G05SC NM-213-051-161-JCAC	M32139/03- A05SN NM-212-009-161-JCAC B05SN NM-212-015-161-JCAC C05SN NM-212-021-161-JCAC D05SN NM-212-025-161-JCAC E05SN NM-212-031-161-JCAC F05SN NM-212-037-161-JCAC G05SN NM-212-051-161-JCAC	M32139/03- A05SS NM-214-009-161-JCAC B05SS NM-214-015-161-JCAC C05SS NM-214-021-161-JCAC D05SS NM-214-025-161-JCAC E05SS NM-214-031-161-JCAC F05SS NM-214-037-161-JCAC G05SS NM-214-051-161-JCAC	M32139/03- A05ST NM-215-009-161-JCAC B05ST NM-215-015-161-JCAC C05ST NM-215-021-161-JCAC D05ST NM-215-025-161-JCAC E05ST NM-215-031-161-JCAC F05ST NM-215-037-161-JCAC G05ST NM-215-051-161-JCAC
M32139/03- A06SC NM-213-009-161-JCAD B06SC NM-213-015-161-JCAD C06SC NM-213-021-161-JCAD D06SC NM-213-025-161-JCAD E06SC NM-213-031-161-JCAD F06SC NM-213-037-161-JCAD G06SC NM-213-051-161-JCAD	M32139/03- A06SN NM-212-009-161-JCAD B06SN NM-212-015-161-JCAD C06SN NM-212-021-161-JCAD D06SN NM-212-025-161-JCAD E06SN NM-212-031-161-JCAD F06SN NM-212-037-161-JCAD G06SN NM-212-051-161-JCAD	M32139/03- A06SS NM-214-009-161-JCAD B06SS NM-214-015-161-JCAD C06SS NM-214-021-161-JCAD D06SS NM-214-025-161-JCAD E06SS NM-214-031-161-JCAD F06SS NM-214-037-161-JCAD G06SS NM-214-051-161-JCAD	M32139/03- A06ST NM-215-009-161-JCAD B06ST NM-215-015-161-JCAD C06ST NM-215-021-161-JCAD D06ST NM-215-025-161-JCAD E06ST NM-215-031-161-JCAD F06ST NM-215-037-161-JCAD G06ST NM-215-051-161-JCAD

-- Continued on next page

SPACE CLASS DESIGNATOR - (S)

Cadmium Plated Aluminum shells are not available with the Space Class Designator; Space Class is optional on Nickel Plated Aluminum, Stainless Steel and Titanium Shells with SAE-AS22759/33 wire. AirBorn part numbers remain the same with or without the Designator.

Military Cross Reference Chart M32139/03

-- Continued from previous page

M32139/03- A07SC NM-213-009-161-JCBE B07SC NM-213-015-161-JCBE C07SC NM-213-021-161-JCBE D07SC NM-213-025-161-JCBE E07SC NM-213-031-161-JCBE F07SC NM-213-037-161-JCBE G07SC NM-213-051-161-JCBE	M32139/03- A07SN(S) NM-212-009-161-JCBE B07SN(S) NM-212-015-161-JCBE C07SN(S) NM-212-021-161-JCBE D07SN(S) NM-212-025-161-JCBE E07SN(S) NM-212-031-161-JCBE F07SN(S) NM-212-037-161-JCBE G07SN(S) NM-212-051-161-JCBE	M32139/03- A07SS(S) NM-214-009-161-JCBE B07SS(S) NM-214-015-161-JCBE C07SS(S) NM-214-021-161-JCBE D07SS(S) NM-214-025-161-JCBE E07SS(S) NM-214-031-161-JCBE F07SS(S) NM-214-037-161-JCBE G07SS(S) NM-214-051-161-JCBE	M32139/03- A07ST(S) NM-215-009-161-JCBE B07ST(S) NM-215-015-161-JCBE C07ST(S) NM-215-021-161-JCBE D07ST(S) NM-215-025-161-JCBE E07ST(S) NM-215-031-161-JCBE F07ST(S) NM-215-037-161-JCBE G07ST(S) NM-215-051-161-JCBE
M32139/03- A08SC NM-213-009-161-JCBG B08SC NM-213-015-161-JCBG C08SC NM-213-021-161-JCBG D08SC NM-213-025-161-JCBG E08SC NM-213-031-161-JCBG F08SC NM-213-037-161-JCBG G08SC NM-213-051-161-JCBG	M32139/03- A08SN(S) NM-212-009-161-JCBG B08SN(S) NM-212-015-161-JCBG C08SN(S) NM-212-021-161-JCBG D08SN(S) NM-212-025-161-JCBG E08SN(S) NM-212-031-161-JCBG F08SN(S) NM-212-037-161-JCBG G08SN(S) NM-212-051-161-JCBG	M32139/03- A08SS(S) NM-214-009-161-JCBG B08SS(S) NM-214-015-161-JCBG C08SS(S) NM-214-021-161-JCBG D08SS(S) NM-214-025-161-JCBG E08SS(S) NM-214-031-161-JCBG F08SS(S) NM-214-037-161-JCBG G08SS(S) NM-214-051-161-JCBG	M32139/03- A08ST(S) NM-215-009-161-JCBG B08ST(S) NM-215-015-161-JCBG C08ST(S) NM-215-021-161-JCBG D08ST(S) NM-215-025-161-JCBG E08ST(S) NM-215-031-161-JCBG F08ST(S) NM-215-037-161-JCBG G08ST(S) NM-215-051-161-JCBG
M32139/03- A09SC NM-213-009-161-JCBH B09SC NM-213-015-161-JCBH C09SC NM-213-021-161-JCBH D09SC NM-213-025-161-JCBH E09SC NM-213-031-161-JCBH F09SC NM-213-037-161-JCBH G09SC NM-213-051-161-JCBH	M32139/03- A09SN(S) NM-212-009-161-JCBH B09SN(S) NM-212-015-161-JCBH C09SN(S) NM-212-021-161-JCBH D09SN(S) NM-212-025-161-JCBH E09SN(S) NM-212-031-161-JCBH F09SN(S) NM-212-037-161-JCBH G09SN(S) NM-212-051-161-JCBH	M32139/03- A09SS(S) NM-214-009-161-JCBH B09SS(S) NM-214-015-161-JCBH C09SS(S) NM-214-021-161-JCBH D09SS(S) NM-214-025-161-JCBH E09SS(S) NM-214-031-161-JCBH F09SS(S) NM-214-037-161-JCBH G09SS(S) NM-214-051-161-JCBH	M32139/03- A09ST(S) NM-215-009-161-JCBH B09ST(S) NM-215-015-161-JCBH C09ST(S) NM-215-021-161-JCBH D09ST(S) NM-215-025-161-JCBH E09ST(S) NM-215-031-161-JCBH F09ST(S) NM-215-037-161-JCBH G09ST(S) NM-215-051-161-JCBH
M32139/03- A10SC NM-213-009-161-JCBA B10SC NM-213-015-161-JCBA C10SC NM-213-021-161-JCBA D10SC NM-213-025-161-JCBA E10SC NM-213-031-161-JCBA F10SC NM-213-037-161-JCBA G10SC NM-213-051-161-JCBA	M32139/03- A10SN(S) NM-212-009-161-JCBA B10SN(S) NM-212-015-161-JCBA C10SN(S) NM-212-021-161-JCBA D10SN(S) NM-212-025-161-JCBA E10SN(S) NM-212-031-161-JCBA F10SN(S) NM-212-037-161-JCBA G10SN(S) NM-212-051-161-JCBA	M32139/03- A10SS(S) NM-214-009-161-JCBA B10SS(S) NM-214-015-161-JCBA C10SS(S) NM-214-021-161-JCBA D10SS(S) NM-214-025-161-JCBA E10SS(S) NM-214-031-161-JCBA F10SS(S) NM-214-037-161-JCBA G10SS(S) NM-214-051-161-JCBA	M32139/03- A10ST(S) NM-215-009-161-JCBA B10ST(S) NM-215-015-161-JCBA C10ST(S) NM-215-021-161-JCBA D10ST(S) NM-215-025-161-JCBA E10ST(S) NM-215-031-161-JCBA F10ST(S) NM-215-037-161-JCBA G10ST(S) NM-215-051-161-JCBA
M32139/03- A11SC NM-213-009-161-JCBC B11SC NM-213-015-161-JCBC C11SC NM-213-021-161-JCBC D11SC NM-213-025-161-JCBC E11SC NM-213-031-161-JCBC F11SC NM-213-037-161-JCBC G11SC NM-213-051-161-JCBC	M32139/03- A11SN(S) NM-212-009-161-JCBC B11SN(S) NM-212-015-161-JCBC C11SN(S) NM-212-021-161-JCBC D11SN(S) NM-212-025-161-JCBC E11SN(S) NM-212-031-161-JCBC F11SN(S) NM-212-037-161-JCBC G11SN(S) NM-212-051-161-JCBC	M32139/03- A11SS(S) NM-214-009-161-JCBC B11SS(S) NM-214-015-161-JCBC C11SS(S) NM-214-021-161-JCBC D11SS(S) NM-214-025-161-JCBC E11SS(S) NM-214-031-161-JCBC F11SS(S) NM-214-037-161-JCBC G11SS(S) NM-214-051-161-JCBC	M32139/03- A11ST(S) NM-215-009-161-JCBC B11ST(S) NM-215-015-161-JCBC C11ST(S) NM-215-021-161-JCBC D11ST(S) NM-215-025-161-JCBC E11ST(S) NM-215-031-161-JCBC F11ST(S) NM-215-037-161-JCBC G11ST(S) NM-215-051-161-JCBC
M32139/03- A12SC NM-213-009-161-JCBD B12SC NM-213-015-161-JCBD C12SC NM-213-021-161-JCBD D12SC NM-213-025-161-JCBD E12SC NM-213-031-161-JCBD F12SC NM-213-037-161-JCBD G12SC NM-213-051-161-JCBD	M32139/03- A12SN(S) NM-212-009-161-JCBD B12SN(S) NM-212-015-161-JCBD C12SN(S) NM-212-021-161-JCBD D12SN(S) NM-212-025-161-JCBD E12SN(S) NM-212-031-161-JCBD F12SN(S) NM-212-037-161-JCBD G12SN(S) NM-212-051-161-JCBD	M32139/03- A12SS(S) NM-214-009-161-JCBD B12SS(S) NM-214-015-161-JCBD C12SS(S) NM-214-021-161-JCBD D12SS(S) NM-214-025-161-JCBD E12SS(S) NM-214-031-161-JCBD F12SS(S) NM-214-037-161-JCBD G12SS(S) NM-214-051-161-JCBD	M32139/03- A12ST(S) NM-215-009-161-JCBD B12ST(S) NM-215-015-161-JCBD C12ST(S) NM-215-021-161-JCBD D12ST(S) NM-215-025-161-JCBD E12ST(S) NM-215-031-161-JCBD F12ST(S) NM-215-037-161-JCBD G12ST(S) NM-215-051-161-JCBD

-- Continued on next page

SPACE CLASS DESIGNATOR - (S)

Cadmium Plated Aluminum shells are not available with the Space Class Designator; Space Class is optional on Nickel Plated Aluminum, Stainless Steel and Titanium Shells with SAE-AS22759/33 wire. AirBorn part numbers remain the same with or without the Designator.



Military Cross Reference Chart

M32139/03

-- Continued from previous page

M32139/03- A13SC NM-213-009-161-JCCE B13SC NM-213-015-161-JCCE C13SC NM-213-021-161-JCCE D13SC NM-213-025-161-JCCE E13SC NM-213-031-161-JCCE F13SC NM-213-037-161-JCCE G13SC NM-213-051-161-JCCE	M32139/03- A13SN NM-212-009-161-JCCE B13SN NM-212-015-161-JCCE C13SN NM-212-021-161-JCCE D13SN NM-212-025-161-JCCE E13SN NM-212-031-161-JCCE F13SN NM-212-037-161-JCCE G13SN NM-212-051-161-JCCE	M32139/03- A13SS NM-214-009-161-JCCE B13SS NM-214-015-161-JCCE C13SS NM-214-021-161-JCCE D13SS NM-214-025-161-JCCE E13SS NM-214-031-161-JCCE F13SS NM-214-037-161-JCCE G13SS NM-214-051-161-JCCE	M32139/03- A13ST NM-215-009-161-JCCE B13ST NM-215-015-161-JCCE C13ST NM-215-021-161-JCCE D13ST NM-215-025-161-JCCE E13ST NM-215-031-161-JCCE F13ST NM-215-037-161-JCCE G13ST NM-215-051-161-JCCE
M32139/03- A14SC NM-213-009-161-JCCG B14SC NM-213-015-161-JCCG C14SC NM-213-021-161-JCCG D14SC NM-213-025-161-JCCG E14SC NM-213-031-161-JCCG F14SC NM-213-037-161-JCCG G14SC NM-213-051-161-JCCG	M32139/03- A14SN NM-212-009-161-JCCG B14SN NM-212-015-161-JCCG C14SN NM-212-021-161-JCCG D14SN NM-212-025-161-JCCG E14SN NM-212-031-161-JCCG F14SN NM-212-037-161-JCCG G14SN NM-212-051-161-JCCG	M32139/03- A14SS NM-214-009-161-JCCG B14SS NM-214-015-161-JCCG C14SS NM-214-021-161-JCCG D14SS NM-214-025-161-JCCG E14SS NM-214-031-161-JCCG F14SS NM-214-037-161-JCCG G14SS NM-214-051-161-JCCG	M32139/03- A14ST NM-215-009-161-JCCG B14ST NM-215-015-161-JCCG C14ST NM-215-021-161-JCCG D14ST NM-215-025-161-JCCG E14ST NM-215-031-161-JCCG F14ST NM-215-037-161-JCCG G14ST NM-215-051-161-JCCG
M32139/03- A15SC NM-213-009-161-JCCH B15SC NM-213-015-161-JCCH C15SC NM-213-021-161-JCCH D15SC NM-213-025-161-JCCH E15SC NM-213-031-161-JCCH F15SC NM-213-037-161-JCCH G15SC NM-213-051-161-JCCH	M32139/03- A15SN NM-212-009-161-JCCH B15SN NM-212-015-161-JCCH C15SN NM-212-021-161-JCCH D15SN NM-212-025-161-JCCH E15SN NM-212-031-161-JCCH F15SN NM-212-037-161-JCCH G15SN NM-212-051-161-JCCH	M32139/03- A15SS NM-214-009-161-JCCH B15SS NM-214-015-161-JCCH C15SS NM-214-021-161-JCCH D15SS NM-214-025-161-JCCH E15SS NM-214-031-161-JCCH F15SS NM-214-037-161-JCCH G15SS NM-214-051-161-JCCH	M32139/03- A15ST NM-215-009-161-JCCH B15ST NM-215-015-161-JCCH C15ST NM-215-021-161-JCCH D15ST NM-215-025-161-JCCH E15ST NM-215-031-161-JCCH F15ST NM-215-037-161-JCCH G15ST NM-215-051-161-JCCH
M32139/03- A16SC NM-213-009-161-JCCA B16SC NM-213-015-161-JCCA C16SC NM-213-021-161-JCCA D16SC NM-213-025-161-JCCA E16SC NM-213-031-161-JCCA F16SC NM-213-037-161-JCCA G16SC NM-213-051-161-JCCA	M32139/03- A16SN NM-212-009-161-JCCA B16SN NM-212-015-161-JCCA C16SN NM-212-021-161-JCCA D16SN NM-212-025-161-JCCA E16SN NM-212-031-161-JCCA F16SN NM-212-037-161-JCCA G16SN NM-212-051-161-JCCA	M32139/03- A16SS NM-214-009-161-JCCA B16SS NM-214-015-161-JCCA C16SS NM-214-021-161-JCCA D16SS NM-214-025-161-JCCA E16SS NM-214-031-161-JCCA F16SS NM-214-037-161-JCCA G16SS NM-214-051-161-JCCA	M32139/03- A16ST NM-215-009-161-JCCA B16ST NM-215-015-161-JCCA C16ST NM-215-021-161-JCCA D16ST NM-215-025-161-JCCA E16ST NM-215-031-161-JCCA F16ST NM-215-037-161-JCCA G16ST NM-215-051-161-JCCA
M32139/03- A17SC NM-213-009-161-JCCC B17SC NM-213-015-161-JCCC C17SC NM-213-021-161-JCCC D17SC NM-213-025-161-JCCC E17SC NM-213-031-161-JCCC F17SC NM-213-037-161-JCCC G17SC NM-213-051-161-JCCC	M32139/03- A17SN NM-212-009-161-JCCC B17SN NM-212-015-161-JCCC C17SN NM-212-021-161-JCCC D17SN NM-212-025-161-JCCC E17SN NM-212-031-161-JCCC F17SN NM-212-037-161-JCCC G17SN NM-212-051-161-JCCC	M32139/03- A17SS NM-214-009-161-JCCC B17SS NM-214-015-161-JCCC C17SS NM-214-021-161-JCCC D17SS NM-214-025-161-JCCC E17SS NM-214-031-161-JCCC F17SS NM-214-037-161-JCCC G17SS NM-214-051-161-JCCC	M32139/03- A17ST NM-215-009-161-JCCC B17ST NM-215-015-161-JCCC C17ST NM-215-021-161-JCCC D17ST NM-215-025-161-JCCC E17ST NM-215-031-161-JCCC F17ST NM-215-037-161-JCCC G17ST NM-215-051-161-JCCC
M32139/03- A18SC NM-213-009-161-JCCD B18SC NM-213-015-161-JCCD C18SC NM-213-021-161-JCCD D18SC NM-213-025-161-JCCD E18SC NM-213-031-161-JCCD F18SC NM-213-037-161-JCCD G18SC NM-213-051-161-JCCD	M32139/03- A18SN NM-212-009-161-JCCD B18SN NM-212-015-161-JCCD C18SN NM-212-021-161-JCCD D18SN NM-212-025-161-JCCD E18SN NM-212-031-161-JCCD F18SN NM-212-037-161-JCCD G18SN NM-212-051-161-JCCD	M32139/03- A18SS NM-214-009-161-JCCD B18SS NM-214-015-161-JCCD C18SS NM-214-021-161-JCCD D18SS NM-214-025-161-JCCD E18SS NM-214-031-161-JCCD F18SS NM-214-037-161-JCCD G18SS NM-214-051-161-JCCD	M32139/03- A18ST NM-215-009-161-JCCD B18ST NM-215-015-161-JCCD C18ST NM-215-021-161-JCCD D18ST NM-215-025-161-JCCD E18ST NM-215-031-161-JCCD F18ST NM-215-037-161-JCCD G18ST NM-215-051-161-JCCD

-- Continued on next page

SPACE CLASS DESIGNATOR - (S)

Cadmium Plated Aluminum shells are not available with the Space Class Designator; Space Class is optional on Nickel Plated Aluminum, Stainless Steel and Titanium Shells with SAE-AS22759/33 wire. AirBorn part numbers remain the same with or without the Designator.

Military Cross Reference Chart M32139/04

-- Continued from previous page

M32139/04- A01TC NM-223-009-261-THAE B01TC NM-223-015-261-THAE C01TC NM-223-021-261-THAE D01TC NM-223-025-261-THAE E01TC NM-223-031-261-THAE F01TC NM-223-037-261-THAE G01TC NM-223-051-261-THAE	M32139/04- A01TN NM-222-009-261-THAE B01TN NM-222-015-261-THAE C01TN NM-222-021-261-THAE D01TN NM-222-025-261-THAE E01TN NM-222-031-261-THAE F01TN NM-222-037-261-THAE G01TN NM-222-051-261-THAE	M32139/04- A01TS NM-224-009-261-THAE B01TS NM-224-015-261-THAE C01TS NM-224-021-261-THAE D01TS NM-224-025-261-THAE E01TS NM-224-031-261-THAE F01TS NM-224-037-261-THAE G01TS NM-224-051-261-THAE	M32139/04- A01TT NM-225-009-261-THAE B01TT NM-225-015-261-THAE C01TT NM-225-021-261-THAE D01TT NM-225-025-261-THAE E01TT NM-225-031-261-THAE F01TT NM-225-037-261-THAE G01TT NM-225-051-261-THAE
M32139/04- A02TC NM-223-009-261-THAG B02TC NM-223-015-261-THAG C02TC NM-223-021-261-THAG D02TC NM-223-025-261-THAG E02TC NM-223-031-261-THAG F02TC NM-223-037-261-THAG G02TC NM-223-051-261-THAG	M32139/04- A02TN NM-222-009-261-THAG B02TN NM-222-015-261-THAG C02TN NM-222-021-261-THAG D02TN NM-222-025-261-THAG E02TN NM-222-031-261-THAG F02TN NM-222-037-261-THAG G02TN NM-222-051-261-THAG	M32139/04- A02TS NM-224-009-261-THAG B02TS NM-224-015-261-THAG C02TS NM-224-021-261-THAG D02TS NM-224-025-261-THAG E02TS NM-224-031-261-THAG F02TS NM-224-037-261-THAG G02TS NM-224-051-261-THAG	M32139/04- A02TT NM-225-009-261-THAG B02TT NM-225-015-261-THAG C02TT NM-225-021-261-THAG D02TT NM-225-025-261-THAG E02TT NM-225-031-261-THAG F02TT NM-225-037-261-THAG G02TT NM-225-051-261-THAG
M32139/04- A03TC NM-223-009-261-THAH B03TC NM-223-015-261-THAH C03TC NM-223-021-261-THAH D03TC NM-223-025-261-THAH E03TC NM-223-031-261-THAH F03TC NM-223-037-261-THAH G03TC NM-223-051-261-THAH	M32139/04- A03TN NM-222-009-261-THAH B03TN NM-222-015-261-THAH C03TN NM-222-021-261-THAH D03TN NM-222-025-261-THAH E03TN NM-222-031-261-THAH F03TN NM-222-037-261-THAH G03TN NM-222-051-261-THAH	M32139/04- A03TS NM-224-009-261-THAH B03TS NM-224-015-261-THAH C03TS NM-224-021-261-THAH D03TS NM-224-025-261-THAH E03TS NM-224-031-261-THAH F03TS NM-224-037-261-THAH G03TS NM-224-051-261-THAH	M32139/04- A03TT NM-225-009-261-THAH B03TT NM-225-015-261-THAH C03TT NM-225-021-261-THAH D03TT NM-225-025-261-THAH E03TT NM-225-031-261-THAH F03TT NM-225-037-261-THAH G03TT NM-225-051-261-THAH
M32139/04- A04TC NM-223-009-261-THAA B04TC NM-223-015-261-THAA C04TC NM-223-021-261-THAA D04TC NM-223-025-261-THAA E04TC NM-223-031-261-THAA F04TC NM-223-037-261-THAA G04TC NM-223-051-261-THAA	M32139/04- A04TN NM-222-009-261-THAA B04TN NM-222-015-261-THAA C04TN NM-222-021-261-THAA D04TN NM-222-025-261-THAA E04TN NM-222-031-261-THAA F04TN NM-222-037-261-THAA G04TN NM-222-051-261-THAA	M32139/04- A04TS NM-224-009-261-THAA B04TS NM-224-015-261-THAA C04TS NM-224-021-261-THAA D04TS NM-224-025-261-THAA E04TS NM-224-031-261-THAA F04TS NM-224-037-261-THAA G04TS NM-224-051-261-THAA	M32139/04- A04TT NM-225-009-261-THAA B04TT NM-225-015-261-THAA C04TT NM-225-021-261-THAA D04TT NM-225-025-261-THAA E04TT NM-225-031-261-THAA F04TT NM-225-037-261-THAA G04TT NM-225-051-261-THAA
M32139/04- A05TC NM-223-009-261-THAC B05TC NM-223-015-261-THAC C05TC NM-223-021-261-THAC D05TC NM-223-025-261-THAC E05TC NM-223-031-261-THAC F05TC NM-223-037-261-THAC G05TC NM-223-051-261-THAC	M32139/04- A05TN NM-222-009-261-THAC B05TN NM-222-015-261-THAC C05TN NM-222-021-261-THAC D05TN NM-222-025-261-THAC E05TN NM-222-031-261-THAC F05TN NM-222-037-261-THAC G05TN NM-222-051-261-THAC	M32139/04- A05TS NM-224-009-261-THAC B05TS NM-224-015-261-THAC C05TS NM-224-021-261-THAC D05TS NM-224-025-261-THAC E05TS NM-224-031-261-THAC F05TS NM-224-037-261-THAC G05TS NM-224-051-261-THAC	M32139/04- A05TT NM-225-009-261-THAC B05TT NM-225-015-261-THAC C05TT NM-225-021-261-THAC D05TT NM-225-025-261-THAC E05TT NM-225-031-261-THAC F05TT NM-225-037-261-THAC G05TT NM-225-051-261-THAC
M32139/04- A06TC NM-223-009-261-THAD B06TC NM-223-015-261-THAD C06TC NM-223-021-261-THAD D06TC NM-223-025-261-THAD E06TC NM-223-031-261-THAD F06TC NM-223-037-261-THAD G06TC NM-223-051-261-THAD	M32139/04- A06TN NM-222-009-261-THAD B06TN NM-222-015-261-THAD C06TN NM-222-021-261-THAD D06TN NM-222-025-261-THAD E06TN NM-222-031-261-THAD F06TN NM-222-037-261-THAD G06TN NM-222-051-261-THAD	M32139/04- A06TS NM-224-009-261-THAD B06TS NM-224-015-261-THAD C06TS NM-224-021-261-THAD D06TS NM-224-025-261-THAD E06TS NM-224-031-261-THAD F06TS NM-224-037-261-THAD G06TS NM-224-051-261-THAD	M32139/04- A06TT NM-225-009-261-THAD B06TT NM-225-015-261-THAD C06TT NM-225-021-261-THAD D06TT NM-225-025-261-THAD E06TT NM-225-031-261-THAD F06TT NM-225-037-261-THAD G06TT NM-225-051-261-THAD

-- Continued on next page

SPACE CLASS DESIGNATOR - (S)

Cadmium Plated Aluminum shells are not available with the Space Class Designator; Space Class is optional on Nickel Plated Aluminum, Stainless Steel and Titanium Shells with SAE-AS22759/33 wire. AirBorn part numbers remain the same with or without the Designator.



Military Cross Reference Chart

M32139/04

-- Continued from previous page

M32139/04- A07TC NM-223-009-261-THBE B07TC NM-223-015-261-THBE C07TC NM-223-021-261-THBE D07TC NM-223-025-261-THBE E07TC NM-223-031-261-THBE F07TC NM-223-037-261-THBE G07TC NM-223-051-261-THBE	M32139/04- A07TN(S) NM-222-009-261-THBE B07TN(S) NM-222-015-261-THBE C07TN(S) NM-222-021-261-THBE D07TN(S) NM-222-025-261-THBE E07TN(S) NM-222-031-261-THBE F07TN(S) NM-222-037-261-THBE G07TN(S) NM-222-051-261-THBE	M32139/04- A07TS(S) NM-224-009-261-THBE B07TS(S) NM-224-015-261-THBE C07TS(S) NM-224-021-261-THBE D07TS(S) NM-224-025-261-THBE E07TS(S) NM-224-031-261-THBE F07TS(S) NM-224-037-261-THBE G07TS(S) NM-224-051-261-THBE	M32139/04- A07TT(S) NM-225-009-261-THBE B07TT(S) NM-225-015-261-THBE C07TT(S) NM-225-021-261-THBE D07TT(S) NM-225-025-261-THBE E07TT(S) NM-225-031-261-THBE F07TT(S) NM-225-037-261-THBE G07TT(S) NM-225-051-261-THBE
M32139/04- A08TC NM-223-009-261-THBG B08TC NM-223-015-261-THBG C08TC NM-223-021-261-THBG D08TC NM-223-025-261-THBG E08TC NM-223-031-261-THBG F08TC NM-223-037-261-THBG G08TC NM-223-051-261-THBG	M32139/04- A08TN(S) NM-222-009-261-THBG B08TN(S) NM-222-015-261-THBG C08TN(S) NM-222-021-261-THBG D08TN(S) NM-222-025-261-THBG E08TN(S) NM-222-031-261-THBG F08TN(S) NM-222-037-261-THBG G08TN(S) NM-222-051-261-THBG	M32139/04- A08TS(S) NM-224-009-261-THBG B08TS(S) NM-224-015-261-THBG C08TS(S) NM-224-021-261-THBG D08TS(S) NM-224-025-261-THBG E08TS(S) NM-224-031-261-THBG F08TS(S) NM-224-037-261-THBG G08TS(S) NM-224-051-261-THBG	M32139/04- A08TT(S) NM-225-009-261-THBG B08TT(S) NM-225-015-261-THBG C08TT(S) NM-225-021-261-THBG D08TT(S) NM-225-025-261-THBG E08TT(S) NM-225-031-261-THBG F08TT(S) NM-225-037-261-THBG G08TT(S) NM-225-051-261-THBG
M32139/04- A09TC NM-223-009-261-THBH B09TC NM-223-015-261-THBH C09TC NM-223-021-261-THBH D09TC NM-223-025-261-THBH E09TC NM-223-031-261-THBH F09TC NM-223-037-261-THBH G09TC NM-223-051-261-THBH	M32139/04- A09TN(S) NM-222-009-261-THBH B09TN(S) NM-222-015-261-THBH C09TN(S) NM-222-021-261-THBH D09TN(S) NM-222-025-261-THBH E09TN(S) NM-222-031-261-THBH F09TN(S) NM-222-037-261-THBH G09TN(S) NM-222-051-261-THBH	M32139/04- A09TS(S) NM-224-009-261-THBH B09TS(S) NM-224-015-261-THBH C09TS(S) NM-224-021-261-THBH D09TS(S) NM-224-025-261-THBH E09TS(S) NM-224-031-261-THBH F09TS(S) NM-224-037-261-THBH G09TS(S) NM-224-051-261-THBH	M32139/04- A09TT(S) NM-225-009-261-THBH B09TT(S) NM-225-015-261-THBH C09TT(S) NM-225-021-261-THBH D09TT(S) NM-225-025-261-THBH E09TT(S) NM-225-031-261-THBH F09TT(S) NM-225-037-261-THBH G09TT(S) NM-225-051-261-THBH
M32139/04- A10TC NM-223-009-261-THBA B10TC NM-223-015-261-THBA C10TC NM-223-021-261-THBA D10TC NM-223-025-261-THBA E10TC NM-223-031-261-THBA F10TC NM-223-037-261-THBA G10TC NM-223-051-261-THBA	M32139/04- A10TN(S) NM-222-009-261-THBA B10TN(S) NM-222-015-261-THBA C10TN(S) NM-222-021-261-THBA D10TN(S) NM-222-025-261-THBA E10TN(S) NM-222-031-261-THBA F10TN(S) NM-222-037-261-THBA G10TN(S) NM-222-051-261-THBA	M32139/04- A10TS(S) NM-224-009-261-THBA B10TS(S) NM-224-015-261-THBA C10TS(S) NM-224-021-261-THBA D10TS(S) NM-224-025-261-THBA E10TS(S) NM-224-031-261-THBA F10TS(S) NM-224-037-261-THBA G10TS(S) NM-224-051-261-THBA	M32139/04- A10TT(S) NM-225-009-261-THBA B10TT(S) NM-225-015-261-THBA C10TT(S) NM-225-021-261-THBA D10TT(S) NM-225-025-261-THBA E10TT(S) NM-225-031-261-THBA F10TT(S) NM-225-037-261-THBA G10TT(S) NM-225-051-261-THBA
M32139/04- A11TC NM-223-009-261-THBC B11TC NM-223-015-261-THBC C11TC NM-223-021-261-THBC D11TC NM-223-025-261-THBC E11TC NM-223-031-261-THBC F11TC NM-223-037-261-THBC G11TC NM-223-051-261-THBC	M32139/04- A11TN(S) NM-222-009-261-THBC B11TN(S) NM-222-015-261-THBC C11TN(S) NM-222-021-261-THBC D11TN(S) NM-222-025-261-THBC E11TN(S) NM-222-031-261-THBC F11TN(S) NM-222-037-261-THBC G11TN(S) NM-222-051-261-THBC	M32139/04- A11TS(S) NM-224-009-261-THBC B11TS(S) NM-224-015-261-THBC C11TS(S) NM-224-021-261-THBC D11TS(S) NM-224-025-261-THBC E11TS(S) NM-224-031-261-THBC F11TS(S) NM-224-037-261-THBC G11TS(S) NM-224-051-261-THBC	M32139/04- A11TT(S) NM-225-009-261-THBC B11TT(S) NM-225-015-261-THBC C11TT(S) NM-225-021-261-THBC D11TT(S) NM-225-025-261-THBC E11TT(S) NM-225-031-261-THBC F11TT(S) NM-225-037-261-THBC G11TT(S) NM-225-051-261-THBC
M32139/04- A12TC NM-223-009-261-THBD B12TC NM-223-015-261-THBD C12TC NM-223-021-261-THBD D12TC NM-223-025-261-THBD E12TC NM-223-031-261-THBD F12TC NM-223-037-261-THBD G12TC NM-223-051-261-THBD	M32139/04- A12TN(S) NM-222-009-261-THBD B12TN(S) NM-222-015-261-THBD C12TN(S) NM-222-021-261-THBD D12TN(S) NM-222-025-261-THBD E12TN(S) NM-222-031-261-THBD F12TN(S) NM-222-037-261-THBD G12TN(S) NM-222-051-261-THBD	M32139/04- A12TS(S) NM-224-009-261-THBD B12TS(S) NM-224-015-261-THBD C12TS(S) NM-224-021-261-THBD D12TS(S) NM-224-025-261-THBD E12TS(S) NM-224-031-261-THBD F12TS(S) NM-224-037-261-THBD G12TS(S) NM-224-051-261-THBD	M32139/04- A12TT(S) NM-225-009-261-THBD B12TT(S) NM-225-015-261-THBD C12TT(S) NM-225-021-261-THBD D12TT(S) NM-225-025-261-THBD E12TT(S) NM-225-031-261-THBD F12TT(S) NM-225-037-261-THBD G12TT(S) NM-225-051-261-THBD

-- Continued on next page

SPACE CLASS DESIGNATOR - (S)

Cadmium Plated Aluminum shells are not available with the Space Class Designator; Space Class is optional on Nickel Plated Aluminum, Stainless Steel and Titanium Shells with SAE-AS22759/33 wire. AirBorn part numbers remain the same with or without the Designator.