

**TRUST
THE
ORIGINAL**

Accessories & Patch Panels



NEUTRIK®

Content	Page
Accessories	4 - 15
Circular Adapters	4
D Shape Adapters	6
Ordering Information	8
AES / EBU Digital Impedance Transformer Adapters	9
Ordering Information	9
DMX Adapters	10
Ordering Information	10
Feedthrough	11
Ordering Information	11
etherCON Feedthrough & Adapter	12
Ordering Information	12
Modules & Audio Transformers	13
Audio Transformer selection Guide	14
Ordering Information	14
Goosenecks	15
Ordering Information	15
Patch Panels	17 - 32
NPPA-Series - 96 Bantam (TT) Jacks	20
Configuration, Grounding, Wiring	21
NPP-TB-Series - 48 B-Gauge Jacks	22
Configuration, Grounding, Wiring	23
1/4" Patch Panel NYS Series	24
Configuration, Grounding	25
MA 96 and XPM 96 Bantam Patchbays	26
MAJ 501 Bantam Jack Socket	27
LF 48 B-Gauge Patchbays	28
LFJ 501 B-Gauge Jack Socket	29
Technical Data	30
Operating Accessories, Labeling software	30
Ordering Information	31
General information:	
Definition, Abbreviation & Useful Information	33
Neutrik Part Number Guide	34
Neutrik Product Line	35

Accessories

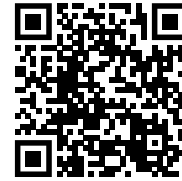

Patch Panels



Introduction

Various connector standards in the professional and semi-professional audio and video world lead to many interconnection challenges.

Neutrik has made it a rule to serve our customers' needs in all its connector offerings and has therefore produced a variety of problem solvers.

With our adapter series we have a solution for the most known interconnection difficulties and in addition we offer modules for the most common connector types to fulfill more specific needs.

Miniature impedance balancing adapters are the answer to the most common noise and grounding problems and for customized designs we recommend our proven audio transformers in combination with our modules.

Neutrik offers a wide range of audio adapters, transformers, AES / EBU adapters and gooseneck products. From problem solvers to connection quick fixes, Neutrik has the most popular audio connectivity solutions. All Neutrik adapters and connectors are soldered with lead free RoHS compliant solder.



Adapter



XLR connector



RCA phono socket



Jack with locking latch



BNC socket

Circular Adapters



NA2FP



NA2MPMM



NA3MJ



NA4FX-F

- Variety of adapters offered to interface with most connector combinations
- Professional look and compact space saving design
- Rugged diecast shell for best reliability
- Compact design and durability with Neutrik quality

NA3FP

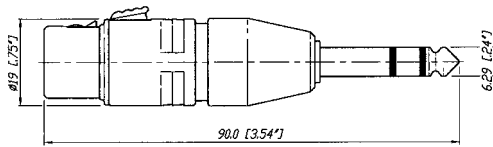

NA4FX-F

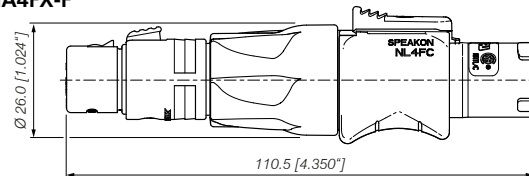

NA3FJ

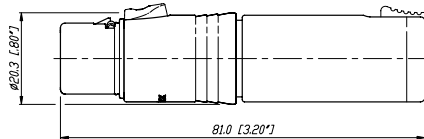

NA2FBNC

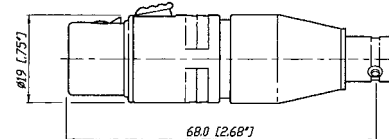

Example drawing. Find more info on www.neutrik.com

Adapter

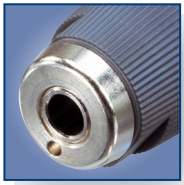

1/4" mono jack



Ergonomic latch design



Rugged diecast shell

Circular Adapters



NA4L



NA3FM



NA3MM



NA3FF-B

- Neutrik speakON NL4FC with 1/4" mono jack (Wiring: +1 to TIP and -1 to SLEEVE)
- Versatile, pre-wired and ready to use adapters to reliably interlock various connector systems
- Based on the XX Series

NA4L

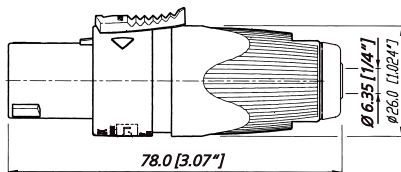

NA3FM

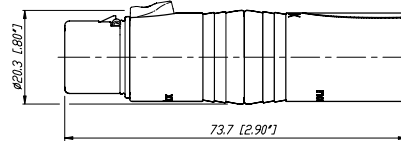

Adapter



Phono socket



speakON NL4MP



Jack with locking latch

D Shape Adapters



NA2BBNC-D9B



NA2M-D2B-TX



NA4MP-J



NA4MP-M-X

- Problem solvers for various intermating problems for professional and semi-professional applications
- Rugged aluminium extrusion housings for best reliability
- Colour coding on all RCA types

Miniature transformer balancing adapters NA2*-TX

- Audio Transformer 1:1 impedance ratio 200:200
- Low cost solution for unbalanced / balanced line conversion and passive DI applications, where no earth or gain switching is required.
- Source / Load impedance 600 / 10 K
Max. input level @ 50 Hz at 1% THD: -3 dBu



NA2F-D0B-TX

NA2BBNC-D9B

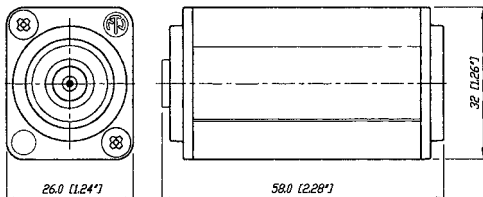

NA4MP-J

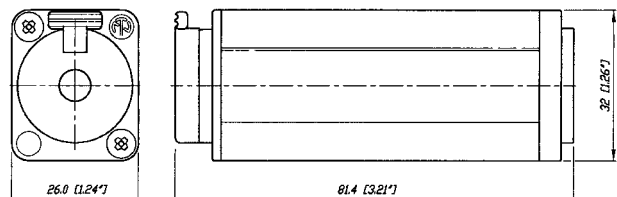

Example drawing. Find more info on www.neutrik.com

Adapter



3 pole XLR male



Locking release tab



powerCON



speakON

D Shape Adapters



NA2M-J-TX



NA2F-D2D-TX



NAC3MM-1



NL8MM

- Miniature transformer balancing adapter
- powerCON NAC3MM-1:
NAC3MPA-1 (power in) - powerCON NAC3MPB-1 (power out), coupler for linking cables
- 8 pole speakON feedthrough adapter for cable extensions

NAC3MM-1

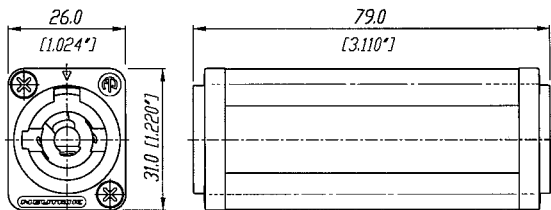

NL8MM

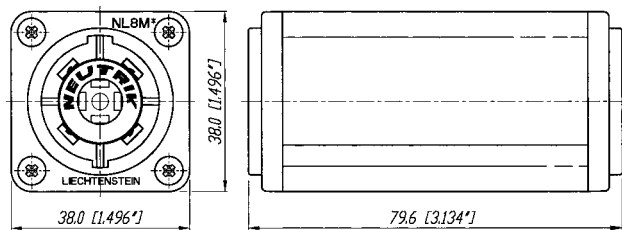

Circular Adapters

Part No.	Port 1	Port 2	Comments
NA2FBNC	3 pole XLR female	BNC socket	1)
NA2FP	3 pole XLR female	TS ²⁾ , 1/4" plug	1)
NA2FPMF	3 pole XLR female	RCA / phono socket	1)
NA2FPMM	3 pole XLR female	RCA / phono plug	1)
NA2MBNC	3 pole XLR male	BNC socket	1)
NA2MP	3 pole XLR male	TS ²⁾ , 1/4" plug	1)
NA2MPMF	3 pole XLR male	RCA / phono socket	1)
NA2MPMM	3 pole XLR male	RCA / phono plug	1)
NA3FF	3 pole XLR female	3 pole XLR female	gender conversion adapter
NA3FF-B	3 pole XLR female	3 pole XLR female	gender conversion, black plating
NA3FJ	3 pole XLR female	TRS ²⁾ , 1/4" jack	locking jack
NA3FM	3 pole XLR female	3 pole XLR male	extension adapter
NA3FMX	3 pole XLR female	3 pole XLR male	contacts 2 - 3 inverted
NA3FP	3 pole XLR female	TRS ²⁾ , 1/4" plug	
NA2JJ	mono 1/4" jack	TS ²⁾ , 1/4" jack	extension adapter
NA3JJ	stereo 1/4" jack	TRS ²⁾ , 1/4" jack	extension adapter, locking jack
NA3MJ	3 pole XLR male	TRS ²⁾ , 1/4" jack	locking jack
NA3MM	3 pole XLR male	3 pole XLR male	gender conversion adapter
NA3MM-B	3 pole XLR male	3 pole XLR male	gender conversion, black plating
NA3MP	3 pole XLR male	TRS ²⁾ , 1/4" plug	
NA5FF	5 pole XLR female	5 pole XLR female	gender conversion adapter
NA5FF-B	5 pole XLR female	5 pole XLR female	gender conversion adapter, black plating
NA5MM	5 pole XLR male	5 pole XLR male	gender conversion adapter
NA5MM-B	5 pole XLR male	5 pole XLR male	gender conversion adapter, black plating
NA4FX-F	speakON NL4FX	3 pole XLR female	speaker adapter ³⁾
NA4FX-M	speakON NL4FX	3 pole XLR male	speaker adapter ³⁾
NA4LJX	speakON NL4FX	TS ²⁾ , 1/4" jack	speaker adapter ³⁾
NL4MMX	4 pole speakON	4 pole speakON	lockable coupler ⁵⁾

D Shape Adapters

NA2BBNC-D4B	BNC socket	RCA / phono socket	colour coded yellow
NA2BBNC-D9B	BNC socket	RCA / phono socket	colour coded white
NA2F-D0B-TX	3 pole XLR female	RCA / phono socket	colour coded black ⁴⁾
NA2F-D2B-TX	3 pole XLR female	RCA / phono socket	colour coded red ⁴⁾
NA2F-J-TX	3 pole XLR female	1/4" jack	ground lifted ⁴⁾
NA2M-D0B-TX	3 pole XLR male	RCA / phono socket	colour coded black ⁴⁾
NA2M-D2B-TX	3 pole XLR male	RCA / phono socket	colour coded red ⁴⁾
NA2M-J-TX	3 pole XLR male	1/4" jack	ground lifted ⁴⁾
NE8FF etherCON	etherCON	RJ45 coupler	
NL8MM	8 pole speakON	8 pole speakON	lockable coupler
NAC3MM-1	3 pole powerCON	3 pole powerCON	lockable coupler
NA4MP-F	speakON NL4MP	3 pole XLR female	speaker adapter ³⁾
NA4MP-J	speakON NL4MP	TS ²⁾ , 1/4" jack	speaker adapter ³⁾
NA4MP-M	speakON NL4MP	3 pole XLR male	speaker adapter ³⁾
NA4MP-M-X	speakON NL4MP	speakON NL4MP	speaker adapter 1+ / 1- inverted ³⁾

1): Wired according to IEC 268-12: pin 2 = signal, pin 1 and 3: connected to ground

2): TRS-Tip, Ring, Sleeve contact (stereo); TS-Tip, Sleeve contact (mono)

3): Detailed wiring info on www.neutrik.com

4): Unbalanced/balanced line conversion, 1:1 transformer 200 Ω : 200 Ω

5): speakON is NOT to be used as an AC mains or power supply connector!

Adapter



3 pole XLR female receptacle



3 pole cable connector



BNC chassis

AES / EBU Digital Impedance Transformer Adapters



NADITBNC-F



NADITBNC-FX



NADITBNC-MX

- Cost effective exceptional impedance matching adapters
- Allow long cable runs for digital audio signals via low attenuation coax lines
- Match balanced (110 Ω) to coaxial lines (75 Ω)
- Pre-wired in black anodized aluminum extrusions for increased durability
- AES/EBU adapters available with either 3 pin male or female XLR cable ends or receptacles
- Simple use, passive units

NADITBNC-FX

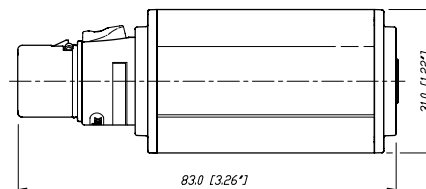

Technical Data

Maximum voltage / Max. power:	5 Vp-p / 250 mW
Frequency band:	0.1 MHz to 6 MHz
Insertion loss:	< 0.3 dB @ 0.1 MHz to 10 MHz
VSWR / Return loss:	< 1.1 / > 26.4 dB

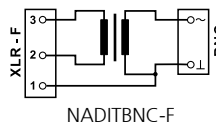

NADITBNC-F

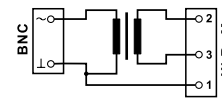

NADITBNC-M

Ordering Information

Part No.	Port 1	Port 2	Comments
	Input	Output	
NADITBNC-F	3 pole XLR female chassis	female BNC chassis	110 Ω XLR input and 75 Ω BNC output
NADITBNC-M	3 pole XLR male chassis	female BNC chassis	75 Ω BNC input and 110 Ω XLR output
NADITBNC-FX	3 pole XLR female cable con.	female BNC chassis	110 Ω XLR input and 75 Ω BNC output
NADITBNC-MX	3 pole XLR male cable con.	female BNC chassis	75 Ω BNC input and 110 Ω XLR output

Adapter



5 pole male connector



5 pole female connector

DMX Adapters



NA3F5M



NA3M5F

- Compact XLR 3 to 5 pole adapters for lighting (DMX) applications
- Solve interconnection problems of the old (3-pole) and new (5 pole) DMX standard
- Enable usage of standard 3 pole microphone cable for DMX applications
- Based on the worldwide accepted standard XLR connectors
- Reliable and rugged diecast shell

NA3F5M

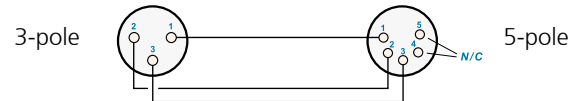
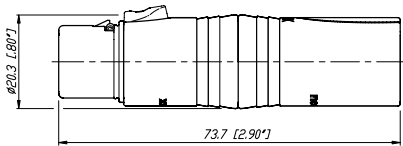

Ordering Information

Part No.	Port 1	Port 2	Comments
NA3F5M	3 pole XLR female	5 pole XLR male	for DMX lighting applications
NA3M5F	3 pole XLR male	5 pole XLR female	for DMX lighting applications



All metal housing

Feedthrough



NA3FDM



NA3MDF

- 3 pole XLR feedthrough adapter
- D-flange chassis mount
- Male to female and vice versa
- Utilizes XX-components

NA3FDM

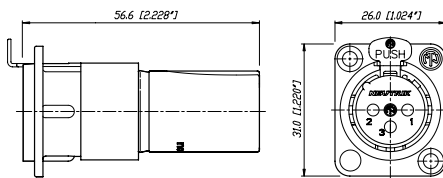

NA3MDF

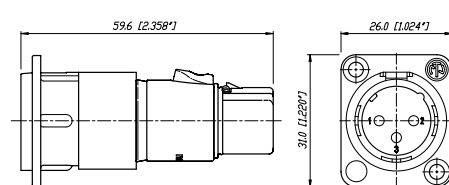

Ordering Information

NA3FDM	3 pole XLR female	3 pole XLR male
NA3MDF	3 pole XLR male	3 pole XLR female

Adapter



Rugged aluminium extrusion housing



Latch lock system



Rugged diecast shell



IP65 Protected in mated condition

etherCON® Feedthrough & CAT6A Adapter

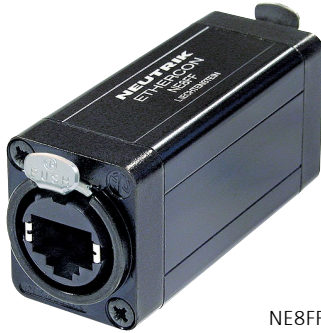

NE8FF



NE8FFX6-W

- Accommodates NE8MC* or any standard RJ45 plug
- NE8FF coupler (adapter) for cable to cable mating – use with NE8MC carriers or any standard RJ45 plugs
- The adapter offers the approved latch lock system

- Ruggedized coupler with CAT6_A component compliance according to ISO/IEC 11801 and TIA/EIA 568-C.2
- IP65 protected when mated with NE8MX6*
- Accommodates standard RJ45 plug
- Revolutionary small form factor
- The adapter offers the million fold proven robust latch lock system
- The adapters are problem solvers for various intermating problems for professional and semi-professional applications

NE8FF

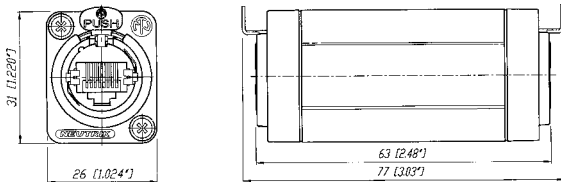

NE8FFX6-W

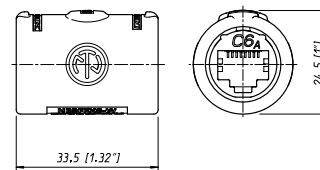

Ordering Information

NE8FF	etherCON feedthrough coupler for cable to cable mating, black plating
NE8FFX6-W	etherCON CAT6A feedthrough coupler for cable extensions, rubber sealing protection, IP65



3 pole plug



SM2/2 switch

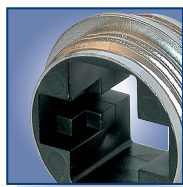

VM housing

Modules & Audio Transformers



NM3FXI



NM3P



KMX



SM2/2



NM3FD-B

- Multifunctional modules allow to design customized adapters to suit specific needs
- Based on the X and D Series connector system
- NTE transformers and switch can be built in
- Professional look, rugged diecast shell

Audio Transformer

- Professional audio transformers for multiple applications, as e.g. microphone or line inputs
- Very low distortion, excellent frequency response
- Cost effective cable version for free wiring
- Fully permalloy-shielded studio versions

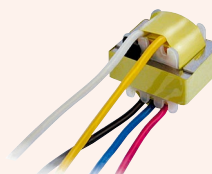

NTE10-3



NTL1

Audio Transformer selection Guide



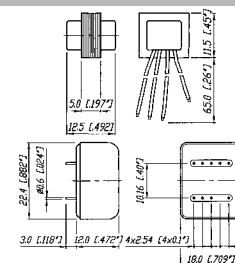

Part No.	Turns Ratio (prim : sec)	Impedance ratio	Source / load impedance in Ω	Max. Input level* @ 50 Hz, 1% THD [dBu]	Applications
NTE1	1 : 1	200 : 200	200 / 2k, (600 / 10k)	-3	General purpose, splitting, XLR inline
NTE4	1 : 4	200 : 3.2k	200 / 10 K	-7	Mic input step-up
NTE10/3	1 : 3	200 : 1.8k	200 / 10 K	-7	General purpose mic input step-up
	1 : 10	200 : 20k	200 / 50 K	-6	
NTL1	1 : 1	10k : 10k	600 / 10k	+19	Line input
NTM1	1 : 1	200 : 200	200 / 2k	+7	Mic input, splitting
NTM4	1 : 4	200 : 3.2k	200 / 10k	+9	Mic input step-up

* : measured with typical source / load impedances

Wiring: NTE*: free wires, NTL / NTM*... PCB mount, shielded; Find detailed specifications on www.neutrik.com

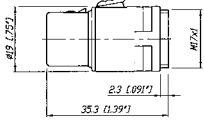
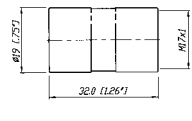
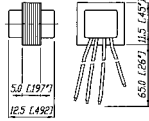
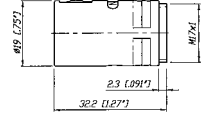
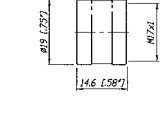
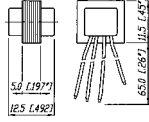
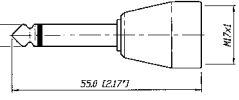
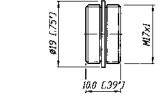
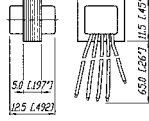
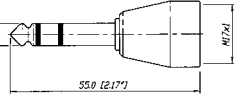
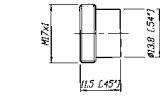
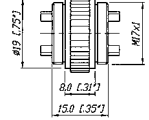
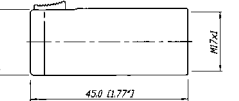
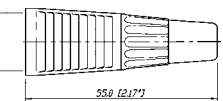
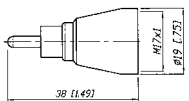

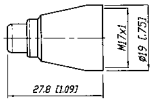
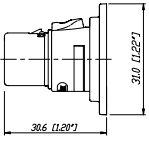
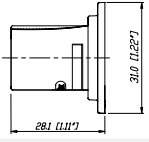
Module Selection Guide

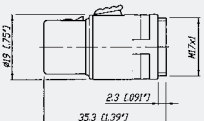
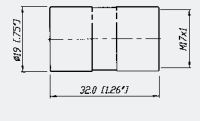
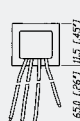
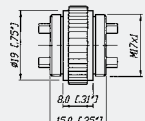
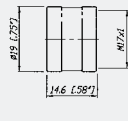
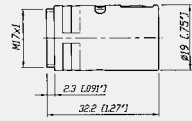
Connector module	Coupler / housing	Transformer / switch
NM3FXI XLR female M17x1 outside 	KM M 17x1 inside 	NTE1 1:1 
NM3MXI XLR male M17x1 outside 	KMX M 17x1 inside 	NTE4 1:4 
NM2P mono 1/4" plug M17x1 inside 	VM M 17x1 outside 	NTE10/3 1:3:10 
NM3P stereo 1/4" plug M17x1 inside 	VMX M 17x1 outside 	SM2/2 2x2 switch M17x1 outside 
NM3J stereo 1/4" jack M17x1 inside 	CM cable outlet M 17x1 inside 	
NMPMM RCA male M17x1 inside 	NA-Housing ¹⁾ black plated screws included 	
NMPMF RCA female M17x1 inside 		
NM3FD-B black plated D-Shape 		
NM3MD-B black plated D-Shape 		
1) ... Combinations possible with all D Shape connectors like e.g. NC3FD-L-1, NF2D, NBB75DSI, etc.		
Example: 		
 NM3FXI	 KM	 NTE1
		 SM2/2
		 KMX
		 NM3MXI



3 pole XLR with
securing ring



Flexible spiral



Integrated cable
outlet

Goosenecks



GN518



GN36



GN550

- For flexible and secure mounting of microphones, lamps etc.
- Versatile, modular system allows various combinations
- Durable stainless steel spiral, no rust, no noise, non-reflective black finish
- Theft proof microphone connection on GNS version (securing ring and fixing screw)
- Strong, flexible and noiseless goosenecks available in three lengths

Ordering Information - Gooseneck & Accessories

Part No.	Description
----------	-------------

Gooseneck:

GN18	M17 x 1 inside thread at both ends	(Ø 12 mm, 230 mm length)
GN36	M17 x 1 inside thread at both ends	(Ø 13 mm, 360 mm length)
GN50	M17 x 1 inside thread at both ends	(Ø 15 mm, 500 mm length)

Gooseneck sets:

GNS18	Gooseneck set GN18, NC3FX-Spec., cable outlet, NAM5 adapter, M17 x 1 bolt thread
GNS36	Gooseneck set GN16, NC3FX-Spec., cable outlet, NAM5 adapter, M17 x 1 bolt thread
GNS50	Gooseneck set GN50, NC3FX-Spec., cable outlet, NAM5 adapter, M17 x 1 bolt thread

Accessories:

NAM4	M17 x 1 outside thread, 5/8" 27 UNS inside thread ¹⁾
NAM5	3/8" inside thread, 5/8" 27 UNS outside thread ¹⁾
GF1	Mounting kit: Flange Ø 63.5 mm including mounting bolt M17x1, 13 mm length ¹⁾
MSG	Mounting bolt M17 x 1, 30 mm length ¹⁾

¹⁾ : Find detailed specifications on www.neutrik.com

GNS Set consisting of:

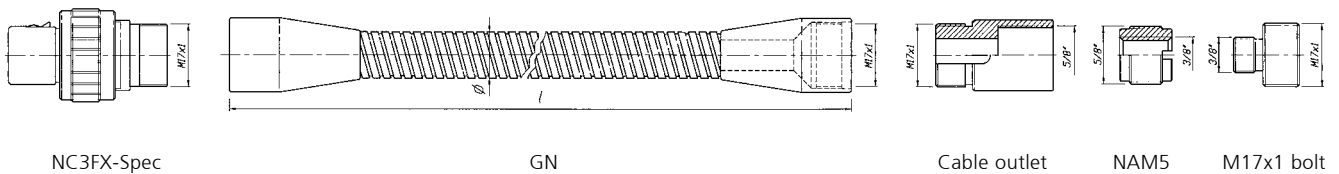

Patch Panels

Content	Page
NPPA-Series - 96 Bantam (TT) Jacks	20
Configuration, Grounding, Wiring	21
NPP-TB-Series - 48 B-Gauge Jacks	22
Configuration, Grounding, Wiring	23
1/4" Patch Panel NYS Series	24
Configuration, Grounding	25
MA 96 and XPM 96 Bantam Patchbays	26
MAJ 501 Bantam Jack Socket	27
LF 48 B-Gauge Patchbays	28
LFJ 501 B-Gauge Jack Socket	29
Technical Data	30
Operating Accessories, Labeling software	30
Ordering Information	31
Definition, Abbreviation & Useful Information	33
Neutrik Part Number Guide	34
Neutrik Product Line	35

Patch Panels



Introduction

Patch Panels are central switching gears between audio equipments. They are used to switch and route analog and digital audio signals from and to equipments in recording or broadcast studios, OB vans, churches, theatres, stadiums, arenas, etc.

Neutrik® Patch Panels are available in a varetly of jack types, wiring and grounding possibilities. Common versions accommodating Bantam TT, 1/4" A-gauge and longframe B-gauge jacks on the front rows are available.

The mechanical size is designed to fit into 1U 19" standard racks. All Neutrik patch panels offer various normalling possibilities between top and bottom row.

All Neutrik® Patch Panels are able to handle digital audio signals acc. AES3, 48kHz sampling rate.



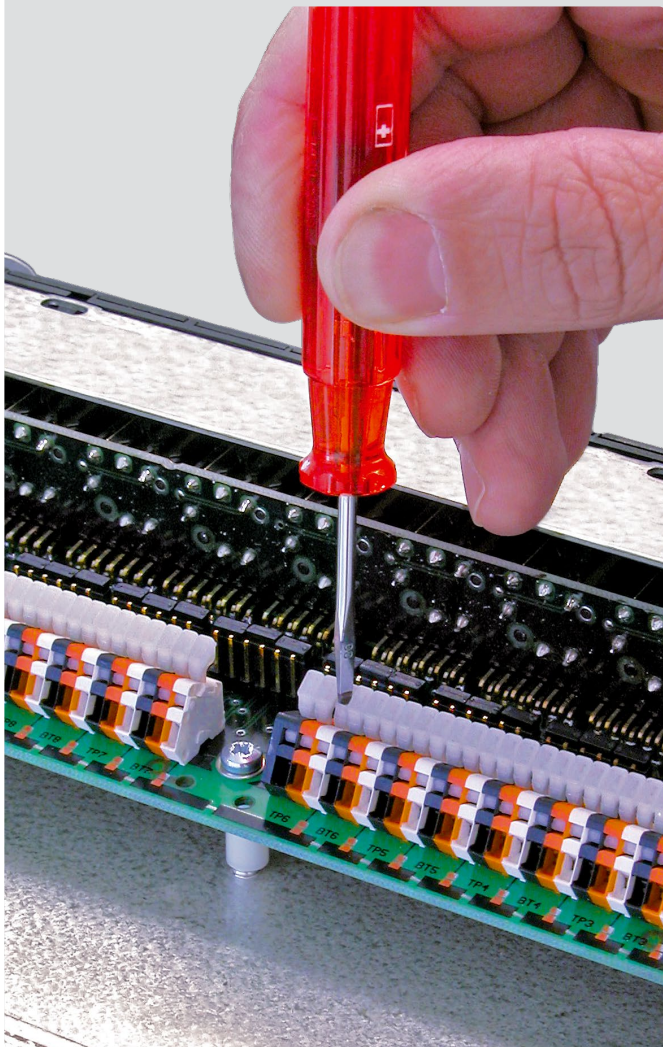
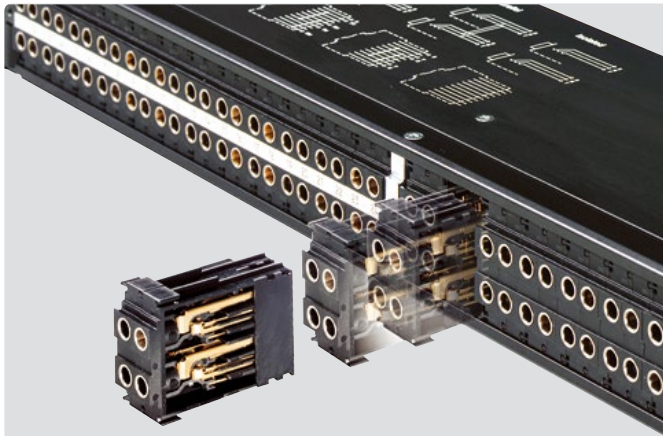

Audio Normalling

Audio Normalling is usually used with audio patch panels and is a wiring pattern in which a circuit path is established from one piece of audio equipment to another without the use of a patch cord. This pattern is then considered to be the „normal“ circuit path that is desired most of the time. If a patch cord is inserted, the normal circuit path is interrupted and rerouted to a different circuit path.

Normalled patch panels are most commonly found in vertical jack pairs: the top jack is designated as the source and the bottom jack is the destination.

Normalling example: HALF NORMALLED BOTTOM ROW

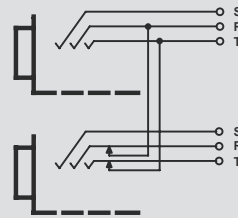

This is the most common configuration, very often called HALF NORMALLED. In this configuration internal normalling contacts connect the top jack contact with the corresponding bottom jack contact. Inserting a plug in the bottom jack will interrupt this internal normalling connection, while inserting a patch cord into the top jack doesn't interrupt the circuit. (Can be used to monitor the normalling circuit)

Inserting a plug in the bottom jack will interrupt this internal normalling connection, while inserting a patch cord into the top jack doesn't interrupt the circuit. (Can be used to monitor the normalling circuit)

Other versions of normalling are Half Normalled Top Row, Full Normalled, Parallel and Isolated.

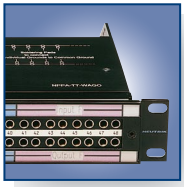

Robust front design



Easy assembly



Jack-pair



IDC terminals



Push terminals

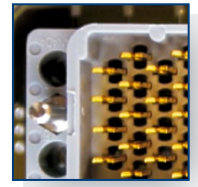

ELCO connectors

NPPA-Series – 96 Bantam (TT) Jacks



NPPA-TT-PT

- Innovative and compact patching system (just 1U high) for 19" rack mounting
- Robustly housed in a black coated steel shell
- Features 2 x 48 long life gold plated TT size (bantam) Neutrik NJ3TTA double contact point TRS jacks
- Available in all common normalling configurations (default Half Normalled Bottom)
- Qualified for analog and digital signals according to AES3, 48 kHz sampling frequency
- Remove the front panel for quick changes of the NJ3TTA-** modules for reconfiguration or repair even when "on air"
- Includes two built in cable bars and two wide channel ID strips
- PatchLink Software for printing onto labeling strips is on Neutrik website (available for PC only)

Dimensional Drawing

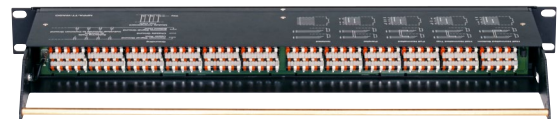
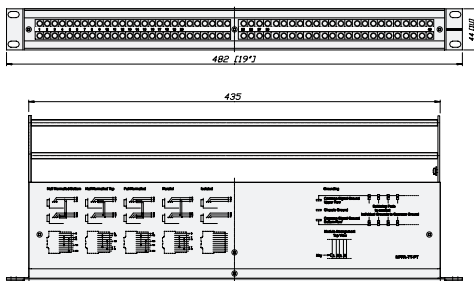

Design Criteria

All NPPA patch panels are fitted with high quality, long life NJ3TTA gold plated double contact jacks (2x48), featuring best contact integrity. The unit, robustly housed in a black coated steel shell, is finished off with a built in cable bar and two large channel identification strips for perfect management of the system. The NPPA patch panels are an innovative and compact patching system (just 1U high) for 19" rack mounting.

Configuration

The standard version of the NPPA Panel is delivered bottom row half normalled for each jack pair by default. Further patch versions are available with fully loaded jack-pairs as:

- Full Normalled
- Half Normalled
- Isolated
- Parallel

For individual normalling single pre-configured jack-pairs are offered.

NPPA-TT-IDC is equipped with jumper blocks for individual switching configurations of each jack channel.

Note: Take care when handling digital signals. Do not use parallel configuration and avoid other parallel paths when using half normalled configurations. Parallel paths may lead to mismatching.

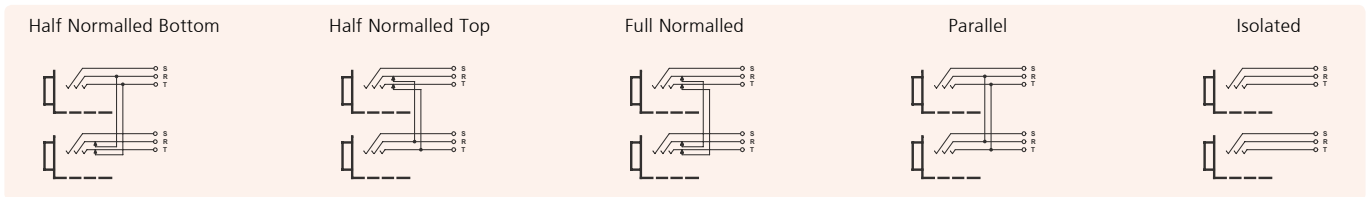

Grounding

The flexible grounding system provides the following versions:

- Individual: Each channel is individually grounded by its corresponding cable shield (default configuration).
- Group: Selected channel grounds are connected via the ground bus on the PCB using solder bridges and track cuts to form a group that is connected to one common cable shield.
- Central: All channel grounds (individual top and bottom row) are connected via the ground bus on the PCB using solder bridges and wired with only one cable shield.
- Chassis-Common: The same as central grounding but with the addition of the common ground bus (top and / or bottom rows) connected to the patch panel chassis by means of jumpers

Wiring Terminations

TT patch panels offer different choices of wiring:

- Spring loaded push terminals
- 56 pin Elco/Edac male connectors
- 90 pin Elco/Edac connectors
- 50 pin D-SUB connectors
- 25 pin D-SUB connectors
- IDC-Krone terminals
- Solder lugs

The spring loaded terminal blocks enable fast and easy wiring. No soldering and screwing necessary. Simply insert the stripped wire after pressing down the white key. Terminals accommodate stranded wires up to AWG 20 (0.5 mm²) and solid wires up to AWG 18 (0.75 mm²). Push terminals are gas tight connections.

For Pin assignment of ELCO / EDAC and D-SUB connectors please see drawings on www.neutrik.com



Individual colour coding

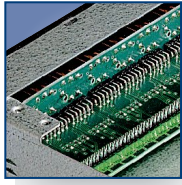

Galvanized metal housing

NPP-TB-Series - 48 B-Gauge Jacks

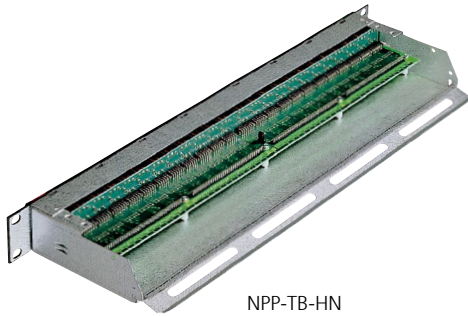

NPP-TB-HN

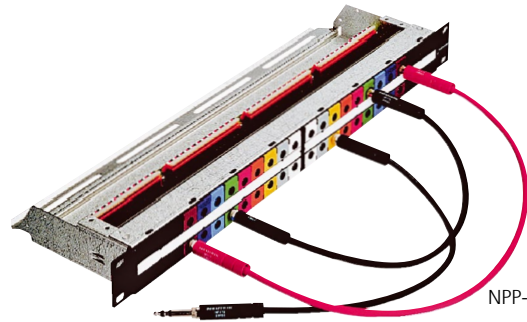

NPP-TB + NPP-LB*

- Features 2 x 24 Neutrik® NJ6TB-V long frame 1/4" TRS jacks according to BPO316/MIL-P-642/2
- Very robust and compact galvanized metal housing
- Compact, cost effective system qualified for both analog and digital signals acc. AES3, 48 kHz sampling frequency
- High quality long life gold plated Neutrik jacks
- Easily programmable for any of 6 configurations with 4 grounding choices
- Rear terminations include solderless terminal blocks or solder lugs (solder for non-programmable half-normalled versions only).
- Center marking strip is removable; See Neutrik website to download PatchLink labeling software for PCs
- Color coded tabs, dust cover and rear extension strain relief bars are optional accessories

Dimensional Drawing

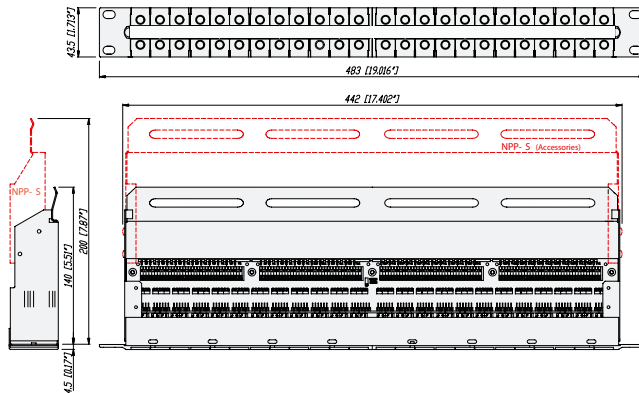

Design Criteria

The NPP-TB patch panels are equipped with gold plated, high quality long life NJ6TB-V Jacks for BPO/MIL style plugs. The panels are easily programmable for six switching configurations and offer a flexible grounding system. The NPP-TB patch panels are very robust and compactly designed for 19" rack mount (19" x 1U) with galvanized metal housing and a built-in cable bar on the rear for securing wires. There is a rear extension bar (NPP-S) available as an option. On the front side there is an

attractive additional lettering area for each channel pair with a marking strip and individual snap-on colour coding plates.

Configuration

Due to the jumper blocks capability provided, the switching configurations available per jack channel are:

- Half Normalled Bottom Row
- Full Normalled
- Parallel
- Isolated

The TB Panel is delivered in a full normalled configuration for each jack channel. A non-configurable half normalled ("-HN") bottom row version with solder lugs is also available.

NOTE: Take care when handling digital signals. Do not use Parallel configuration and avoid other parallel paths with Half / Double Normalled configurations. Parallel paths may lead to mismatching.

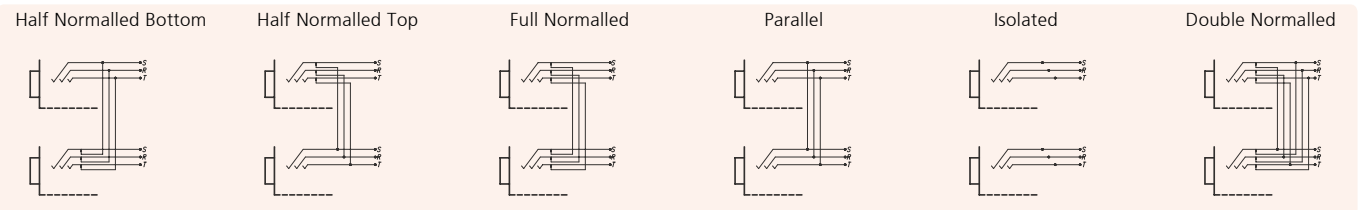

Grounding

The flexible grounding system allows four possibilities to fit your needs:

- Individual: Each channel ground is separately connected with the corresponding cable shield (default configuration).
- Group: Some channel grounds are PCB connected by making soldering joints on the PCB and by cutting tracks respectively to form a group that is connected to one common cable shield.
- Central: All channel grounds are PCB connected by making soldering joints and wired with only one cable shield.
- Chassis-Common: Same as central grounding with additional connection of the common ground to the Patch Panel chassis by means of a jumper.

Wiring Terminations

TB patch panels are available with:

- Spring loaded push terminals (NPP-TB)
- Solder lugs (NPP-TB-HN)

The spring loaded terminal blocks are fast and easy to connect and disconnect the wires. No soldering and screwing necessary. Simply insert the stripped wire after pressing down the white key. Accommodates stranded wires up to AWG 20 (0.5 mm²) and solid wires up to AWG 18 (0.75 mm²).



Imprinted grounding instruction

Module NYS-SPCR1

1/4" Patch Panel

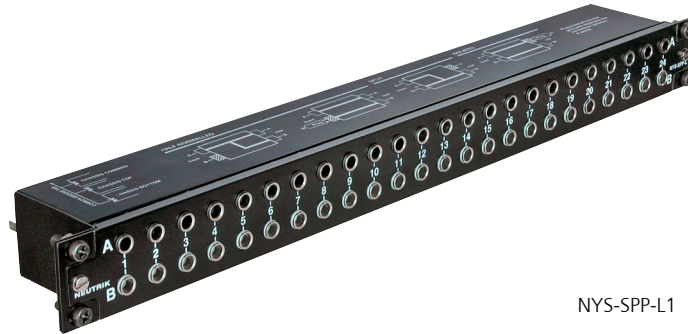

NYS-SPP-L1

- Individual grounding available for each channel separately
- Ruggedized metal housing
- Improved contact design minimises wear on mated plugs
- Economic and versatile designed 1/4" modular patch panel with 2 rows of jack sockets
- 48 balanced channels with fully PCB wired jack (24 vertical PC boards), 24 front pairs and corresponding 24 rear pairs
- Jack PC card contains 4 balanced 1/4" jacks with non-tarnishing contacts, is held securely in place without the use of nuts - no little pieces to drop, break or lose
- Easy to change configuration by just flipping individual PC board
- Normalling jack is coloured grey for easy identification
- 4 designation strips included for front and rear panel

Dimensional Drawing

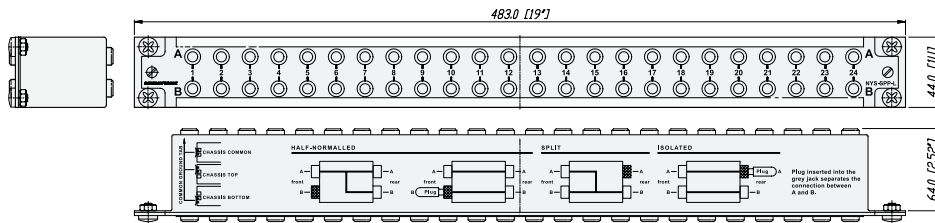

Design Criteria

The NYS-SPP-L1 is a economical and remarkable sleek designed 1/4" modular patch panel for 19" rack mount (19" x 1U) with a reinforced metal housing. Each of it's 48 PCB wired balanced channels (24 front pairs and corresponding 24 rear pairs) can either be grounded separately or in groups of individually chooseable channel numbers (detailed information see below).

The PCBs are held securely in place by being clamped between the front and the rear panel, this grants an easy reconfiguration of the patch panel without the danger of loosing any small parts (e.g. nuts). The grey jack serves as an easy and distinguishable normalling identification.

Configuration

Standard configuration, when delivered, is Half Normalled bottom row. The configuration can easily be changed by just flipping the individual PCB. Inserting a plug into the

grey jack will always isolate the top against the bottom row. Alternative solution for send / return applications by use of NYS-SPCR1 module (see accessories below).

The following configurations are available:

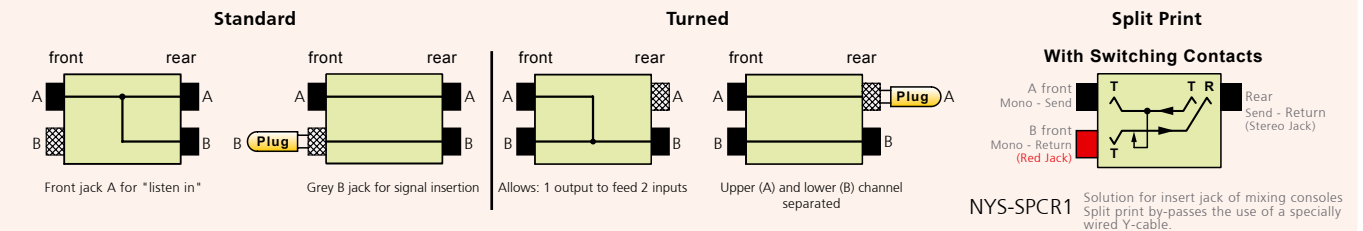

Grounding

The flexible grounding system, applicable for each channel separately by simply attaching the loose supplied grounding clips to the grounding pad of the corresponding channel, offers the following alternatives:

- Individual (without grounding clip): Each channel ground (sleeve contact) is connected to the dedicated ground contact of the incoming 1/4" plug only. This is the standard configuration for delivery.
- Chassis common ①: The relevant channel grounds (sleeve contacts; top and bottom row) is connected to the ground flat tab via grounding clip and chassis.
- Chassis top ②: The dedicated top channel ground (sleeve contact) is connected to the ground flat tab via grounding clip and chassis.
- Chassis bottom ③: The dedicated bottom channel ground (sleeve contact) is connected to the ground flat tab via grounding clip and chassis.

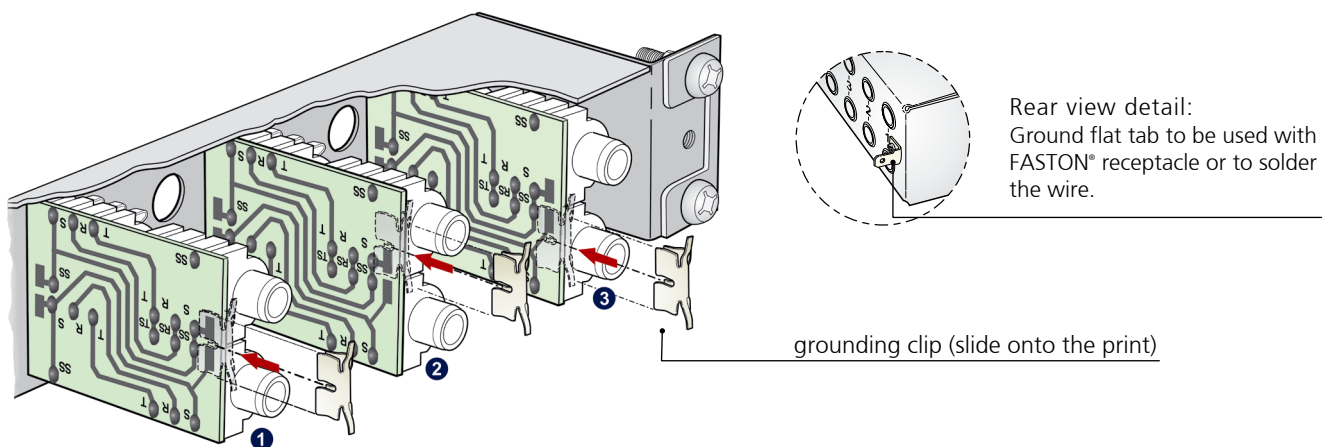



Standard 4.4mm
bantam jack



Long frame jack
socket

MA 96 and XPM 96 Bantam Patchbays

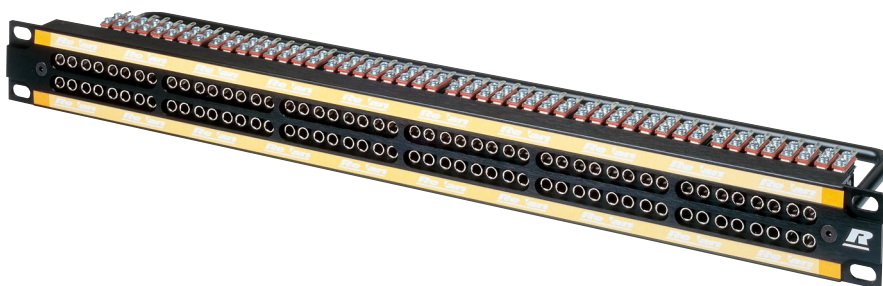

- Robust designed patchbay to accept standard 4.4 mm Bantam jack connectors (acc. MIL-D-642/13)
- Fitted with 96 Rean die-cast jack sockets
- Constructed from rigid aluminium extrusion which includes 2 integral slots for designation strips
- 96 channels grouped in two row 12 x 8 stereo jacks
- XPM96 features traditional 2 row, 4 x 24 stereo jacks
- Available in 4 colours: black, silver, red or blue
- Suitable for audio, broadcast, data and industrial applications XPM96

Dimensional Drawing

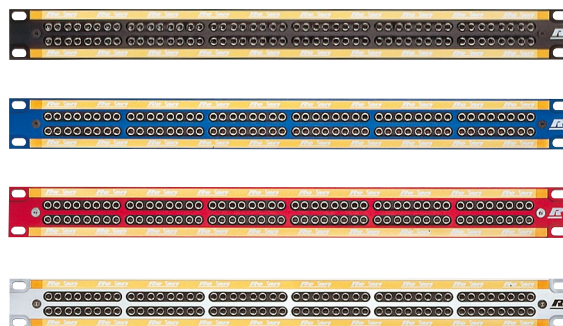
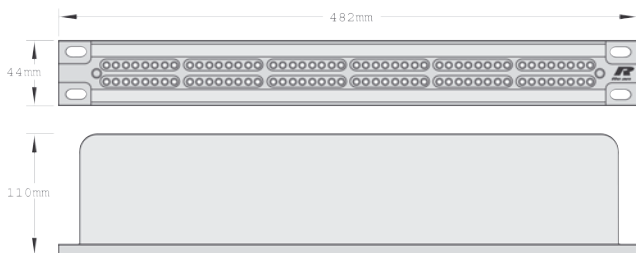

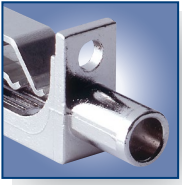

Die-cast frame



Tinned tags

MAJ 501 Bantam Jack Socket

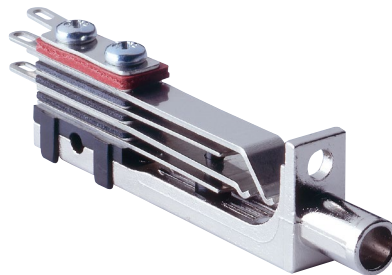

- 5-point Bantam jack socket (Tip, Ring, Sleeve, Tip Normal, Ring Normal)
- Rigid nickel plated die-cast frame, featuring considerable frame strength eliminating physical distortion when plug is inserted
- Nickel-silver spring contacts, palladium plated switch contacts
- Tinned tags for easy soldering

Termination

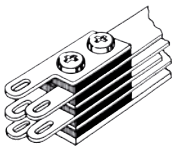

End Elevations

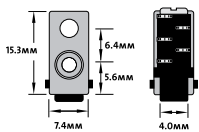

Plan Elevations

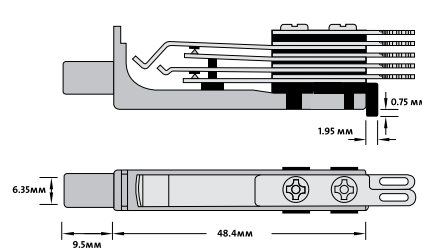

Circuit Detail

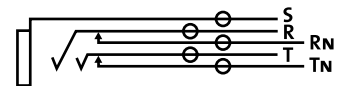



B-Gauge patchbay



48 way longframe

LF 48 B-Gauge Patchbays



- 48 way Longframe B-Gauge patchbay
- Accepts both European BPO 316 and US MIL-P-642/2 style phono plugs
- 2 rows of 24 LF501 jack connectors
- Jack designed from rigid nickel-plated die-cast aluminium with nickel-silver spring contacts
- Available in 4 colours: black, silver, red or blue
- Reliable support for connecting looms by steel lacing bar

Dimensional Drawing

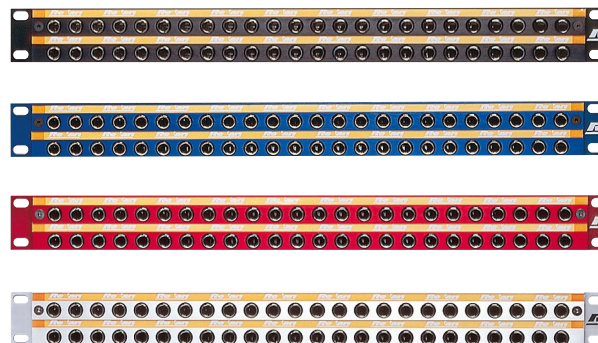
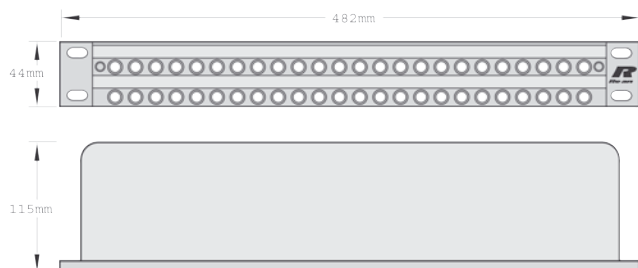

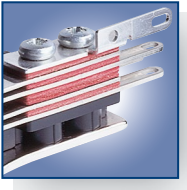

LFJ 501 B-Gauge Jack Socket

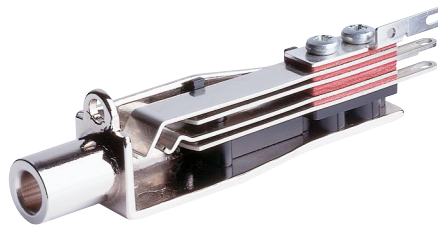

- 5-point B-Gauge jack socket
- Nickel-silver spring contacts
- Palladium plated switch contacts
- Durable die-cast body with bright nickel plated nose
- Termination solder lugs

LFJ 501

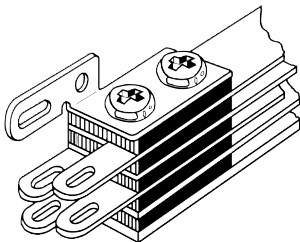

Plan Elevations

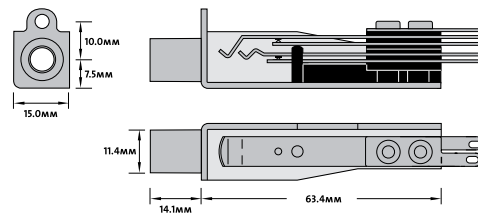

Circuit Detail

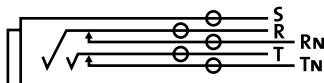

Specifications	NPPA Series	NPP-TB Series	NYS Series	MA 96 and XPM 96	LF 48 Series
----------------	-------------	---------------	------------	------------------	--------------

Electrical

Contact resistance:	< 20 mΩ	< 10 mΩ	< 10 mΩ	< 24 mΩ	< 20 mΩ
Switch contact resistance:	< 25 mΩ	< 15 mΩ	< 10 mΩ	< 26 mΩ	< 15 mΩ
Insulation resistance:	> 1 GΩ @ 500 V dc	●	●	●	●
Dielectric strength:	> 500 V ac	●	●	●	●
	> 1'000 V dc	●	●	-	-
Frequency range:	DC to > 50 MHz	●	●	●	●
Channel separation:	> 100 dB @ 10 kHz	●	●	●	●
	600 Ω terminated				
	> 40 dB @ 6 MHz	●	●	●	●
	110 Ω terminated				
AES / EBU Signals (digital) suitable:	●	●	●	●	●
Handles Phantom Power:	●	●	●	●	●

Mechanical

Life time:	> 20'000 cycles	-	-	-	●	●
	> 10'000 cycles	-	-	●	-	-
	> 5'000 cycles	●	●	-	-	-
Insertion force:	< 25 N	-	-	-	●	●
	< 20 N	-	-	●	-	-
	< 10 N	●	●	-	-	-
Withdrawal force:	> 10 N	●	●	●	●	●
	> 8 N	●	●	-	-	-
Dimensions:	482 x 44 mm (19" x 1U)	●	●	●	●	●
Depth:		178 mm (7")	140 mm (5.5")	64 mm (2.52")	110 mm (4.33")	115 mm (4.53")
Dimension Patch Box:	168 x 77 x 77 mm (6.0 x 3 x 3")					
Temperature range:	- 30 °C to + 80 °C	●	●	●	●	●
Mating plug:		4.4 mm (0.173") Bantam plug	B-Gauge 1/4" plug	A-Gauge 1/4" plug acc. EIA RS-453	4.4 mm (0.173") Bantam plug	Longframe B-Gauge plug
	according	MIL-P-642/13	BPO316/MIL-P-642/2	TEC60603-11	MIL-P-642/13	BPO316/MIL-P-642/2
Grounding wiring	flat tab for 3/16" FASTON® (4.8 x 0.8 mm)	-	-	●	-	-

Material

Housing:	Steel	Steel	Steel	anodised Al	anodised Al
Front panel:	anodised Al	Pocan B 3225	Steel	anodised Al	anodised Al
Lacing bar:	Brass	Steel	N / A	coated steel	coated steel
Jack housing:	PA 66 blend	PA 6.6 30% GR	ABS	diecast alloy	diecast Al
Jack contacts:	CuSn6 Tribor® plated	CuSn6 Au plated	CuSn6 tin plated	Ni-Silver (CuNi18Zn20)	Ni-Silver (CuNi18Zn20)
Switch contacts:	Au plated	Au plated	Bronze, tin plated	Palladium plated	Palladium plated
Grounding clip:	-	-	CuSn6, SnCu plated	-	-

Operating Accessories

Labeling software

Patchlabel is a program to Label Patch Panel designation strips.

Free Download of Patch Label Program (ZIP – 347 KB) on the Web "www.neutrik.com" section

"Patch Panels" .



Part Number	Description
-------------	-------------

NPPA Series		Configuration*	Wiring	Grounding
NPPA-TT-PT**	2 x 48 jacks	half normalled bottom	288 push terminals	individual
NPPA-TT-PT-FN**	2 x 48 jacks	full normalled	288 push terminals	individual
NPPA-TT-PT-HNT**	2 x 48 jacks	half normalled top row	288 push terminals	individual
NPPA-TT-PT-I**	2 x 48 jacks	isolated	288 push terminals	individual
NPPA-TT-PT-P**	2 x 48 jacks	parallel	288 push terminals	individual
NPPA-TT-S**	2 x 48 jacks	half normalled bottom	288 solder terminals	individual
NPPA-TT-S-FN**	2 x 48 jacks	full normalled	288 solder terminals	individual
NPPA-TT-S-HNT**	2 x 48 jacks	half normalled top row	288 solder terminals	individual
NPPA-TT-S-I**	2 x 48 jacks	isolated	288 solder terminals	individual
NPPA-TT-S-P**	2 x 48 jacks	parallel	288 solder terminals	individual
NPPA-TT-PT-PH	2 x 48 jacks	half normalled bottom	288 Phoenix push terminals	individual
NPPA-TT-SD50	2 x 48 jacks	half normalled bottom	4 x 50 pole D-SUB	groups of 12 channels
NPPA-TT-SD25	2 x 48 jacks	half normalled bottom	12 x 25 pole D-SUB	groups of 12 channels
NPPA-TT-E56	2 x 48 jacks	half normalled bottom	6 x 56 pole ELCO male connectors	individual
NPPA-TT48-E56	2 x 24 jacks	half normalled bottom	3 x 56 pole ELCO male connectors	individual
NPPA-TT-E90	2 x 48 jacks	half normalled bottom	4 x 90 pole ELCO male connectors	individual
NPPA-TT-IDC	2 x 48 jacks	programmable by jumpers	288 IDC terminals (KRONE-Type)	individual

* : fully loaded jack pairs only, to built patch panels with mixed configuration use pre-config jackpairs

** : in case of need added normalling bars can be used to reconfigure up to 4 jackpairs

Pre-configured Jack-Pairs

NJ3TTA-4-HNB	blocks of 2 channels	half normalled bottom row	cover ident color: clear
NJ3TTA-4-HNT	blocks of 2 channels	half normalled top row	cover ident color: yellow
NJ3TTA-4-FN	blocks of 2 channels	full normalled	cover ident color: green
NJ3TTA-4-P	blocks of 2 channels	parallel	cover ident color: red
NJ3TTA-4-I	blocks of 2 channels	isolated	cover ident color: orange

Accessories

NPPA-S	Strain Relief bar
NKTT*	Patch cords with NP3TT-1 plugs. Available in black, blue, green, red and yellow. Length: 30, 40, 60, 90, 120 cm

NPP-TB Series

NPP-TB Series		Configuration	Wiring
NPP-TB	2 x 24 TB (BP0316/MIL-P-642/2) jacks	programmable for all commonly used configurations	push terminals
NPP-TB-HN	2 x 24 TB (BP0316/MIL-P-642/2) jacks	half Normalled Bottom Row	solder tags

Accessories

NPP-LB-**	Channel identification and status plates, pack of 100 per color, 9 different colors
NPP-C	Metal dust cover
NPP-S	A second rear extension bar for fix the very large cables.
NKTB*	Patch cord with NP3TB plugs. Available in black and red. Length: 30, 40, 60, 90 cm
** : 0 - Black, 1 - Brown, 2 - Red, 3 - Orange, 4 - Yellow, 5 - Green, 6 - Blue, 7 - Violet, 8 - Grey, 9 - White; Must be ordered in multiples of 100.	



NYS SPPL

NYS-SPP-L1	1/4" Patch Panel, 2 x 24 channels, configuration half normalled, isolated, split
NYS-SPCR1	Send / Return module (Split Print)

Part Number	Description
-------------	-------------

MA96 and XPM-96

MA96-1A	96 way, Red front panel – grouped 12 x 8
MA96-1D	96 way, Blue front panel – grouped 12 x 8
MA96-1O	96 way, Black front panel – grouped 12 x 8
MA96-1S	96 way, Silver front panel – grouped 12 x 8
XPM-96SS	96 way, Silver front panel – grouped 4 x 24
XPM-96SO	96 way, Black front panel – grouped 4 x 24

Bantam Jack Socket

MAJ-501	Standard Solder Tag
---------	---------------------

LF48 Longframe B-Gauge Patchbays

LF48-1A	48 way, Red front panel
LF48-1D	48 way, Blue front panel
LF48-1O	48 way, Black front panel
LF48-1S	48 way, Silver front panel
LFJ-501	Longframe B-Gauge jack socket, standard solder tag

Definitions, Abbreviations & Useful Information

ELEMENTS

Ag	Silver
Al	Aluminium
Au	Gold
Co	Cobalt
Cr	Chromium
Cu	Copper
Ni	Nickel
P	Phosphorus
Pb	Lead
Pd	Palladium
Sn	Tin
Zn	Zinc
SS	Stainless Steel

ALLOYS, PLASTICS, POLYMERS

Brass (Alloy)	CuZn39Pb3
Bronze (Alloy)	CuSn6
Ck 67	Carbon Steel
EPDM	Ethylene Propylene
GR	Glass Reinforced
PA	Polyamide
PBTP	Polybutylene Terephthalate
POM	Polyacetal
PTFE	PolyTetraFluoroEthylene (TEFLON)
PUR	Polyurethane

MEASUREMENT LEGEND

N	Newton
Ω	Ohm
μ	Micro
OD	Outside Diameter
m	Meter(s)
k	Kilo

ENGLISH TO METRIC CONVERSIONS



1/8 inch	3.175	millimeters (mm)
1/4 inch	6.35	millimeters (mm)
1 inch	25.4	millimeters (mm)
	2.54 cm	1 inch
1 foot	30.48	centimeters (cm)
	0.305	meter (m)
6 foot	1.828	meters (m)
50 foot	15.24	meters (m)
100 foot	30.48	meters (m)
1000 foot	304.8	meters (m)

METRIC TO ENGLISH CONVERSIONS

1 centimeter	0.3937	inches
1 meter	39.37	inches
3.281 meter	10	feet
10 meters	32.808	feet
50 meters	164.041	feet
100 meters	328.084	feet

OTHER ABBREVIATIONS

UL®	Underwriters Laboratories
IP Rating	Ingress Protection rating for objects and water ACC IEC529/EN60529
IEC	International Electrotechnical Commission is the international standards and conformity assessment body for all fields of electrotechnology
UL	UL Recognized Component Mark

	ENEC – European norms electrical certification, demonstrates compliance with European safety standards.
	VDE Association for Electrical, Electronic and Information Technologies e.V.
AWG	American Wire Gauge

NEUTRIK, crystalCON®, etherCON®, maxCON®, miniCON®, nanoCON®, neutriCON®, opticalCON®, powerCON®, Profi®, rearTWIST®, silentPLUG®, speakON®, TOP®, DiWA®, XIRIUM®, are registered trademarks of Neutrik AG.

Neutrik® Part Number Guide

NC3FAH1-B-0-D

Packaging:	D	Cable connector: bulk packed
Assembly:	D	Chassis connector: disassembled push latch
Retention:	w/o	Latch lock
	-0	Retention spring
	-DA	Asymmetric PUSH
	B	Black shell, gold contacts
Shell:	BAG	Black shell, silver contacts
	0	Separate ground contact connected to shell, male only
Grounding:	1	Pin 1 & panel & shell connected, no separate ground contact
	2	Separate ground contact connected to shell & panel, separate Pin 1
	E	Additional ground contacts
	w/o number	No ground/shell contact (except 4/5 pole), female only
	Termination:	H
HL		Lateral left PCB mount
HR		Lateral right PCB mount
L		Solder cups
V		Vertical PCB mount
Y		IDC for wires (no ground)
M3		Mounting holes with M3 thread
M25		Mounting holes with M2.5 thread
-		Not applicable
Series:		A, AA, B, D, DL, DLX, MPR, P, PX, RX, X, XX
Gender:	F	Female
	M	Male
Number of Contacts:	2, 3, 4, 5, 6, 7, 8, 12	
Connector Type:	A	Adapter
	AC	powerCON
	B	BNC
	C	XLR
	D	dummyPLUG
	E	etherCON - RJ45
	F	RCA / CINCH
	J (MJ, RJ, SJ)	Jack
	K	Cable Assembly
	L	speakON - Loudspeaker
	M	Module
	O	opticalCON - Fiber Optic Connector
	P	Plug
	PP	Patch Panel
	R	Circular Connector
	T	Transformer
	TOP	True Outdoor Protection

Definitions, abbreviations & useful information see page 33.

Neutrik® Product Line

<p>XLR Connectors</p>	<p>Plugs & Jacks</p>	<p>SpeakON® Connectors</p>	<p>Data Connectors</p>	<p>Circular Connectors</p>	<p>powerCON® Connectors</p>	<p>Patch Panels</p>	<p>Accessories</p>	<p>Digital Audio Network</p>
------------------------------	---------------------------------	-----------------------------------	-------------------------------	-----------------------------------	------------------------------------	----------------------------	---------------------------	-------------------------------------