

MMBTH10L, MMBTH10-4L, SMMBTH10-4L, NSVMMBTH10L



ON Semiconductor®

www.onsemi.com

VHF/UHF Transistor

NPN Silicon

Features

- S and NSV Prefixes for Automotive and Other Applications Requiring Unique Site and Control Change Requirements; AEC-Q101 Qualified and PPAP Capable
- These Devices are Pb-Free, Halogen Free/BFR Free and are RoHS Compliant



SOT-23 (TO-236)
CASE 318
STYLE 6

MAXIMUM RATINGS

Rating	Symbol	Value	Unit
Collector-Emitter Voltage	V_{CEO}	25	Vdc
Collector-Base Voltage	V_{CBO}	30	Vdc
Emitter-Base Voltage	V_{EBO}	3.0	Vdc

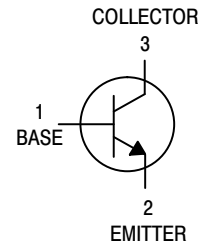

THERMAL CHARACTERISTICS

Characteristic	Symbol	Max	Unit
Total Device Dissipation FR-5 Board (Note 1) $T_A = 25^\circ\text{C}$ Derate above 25°C	P_D	225 1.8	mW mW/ $^\circ\text{C}$
Thermal Resistance, Junction to Ambient (Note 1)	$R_{\theta JA}$	556	$^\circ\text{C}/\text{W}$
Total Device Dissipation Alumina Substrate (Note 2) $T_A = 25^\circ\text{C}$ Derate above 25°C	P_D	300 2.4	mW mW/ $^\circ\text{C}$
Thermal Resistance, Junction to Ambient (Note 2)	$R_{\theta JA}$	417	$^\circ\text{C}/\text{W}$
Junction and Storage Temperature Range	T_J, T_{stg}	-55 to +150	$^\circ\text{C}$

Stresses exceeding those listed in the Maximum Ratings table may damage the device. If any of these limits are exceeded, device functionality should not be assumed, damage may occur and reliability may be affected.

1. FR-5 = 1.0 x 0.75 x 0.062 in.
2. Alumina = 0.4 x 0.3 x 0.024 in. 99.5% alumina

MARKING DIAGRAMS

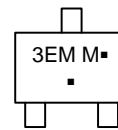

MMBTH10LT1G,
NSVMMBTH10LT1G

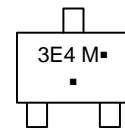

MMBTH10-04LT1G

3EM, 3E4 = Specific Device Code
M = Date Code*
▪ = Pb-Free Package

(Note: Microdot may be in either location)
*Date Code orientation and/or overbar may vary depending upon manufacturing location.

ORDERING INFORMATION

Device	Package	Shipping†
MMBTH10LT1G	SOT-23 (Pb-Free)	3,000 / Tape & Reel
NSVMMBTH10LT1G	SOT-23 (Pb-Free)	3,000 / Tape & Reel
MMBTH10-4LT1G	SOT-23 (Pb-Free)	3,000 / Tape & Reel
MMBTH10LT3G, SMMBTH10-4LT3G	SOT-23 (Pb-Free)	10,000 / Tape & Reel

†For information on tape and reel specifications, including part orientation and tape sizes, please refer to our Tape and Reel Packaging Specifications Brochure, BRD8011/D.

MMBTH10L, MMBTH10-4L, SMMBTH10-4L, NSVMMBTH10L

ELECTRICAL CHARACTERISTICS ($T_A = 25^\circ\text{C}$ unless otherwise noted)

Characteristic	Symbol	Min	Typ	Max	Unit
----------------	--------	-----	-----	-----	------

OFF CHARACTERISTICS

Collector-Emitter Breakdown Voltage ($I_C = 1.0\text{ mA}$, $I_E = 0$)	$V_{(BR)CEO}$	25	-	-	Vdc
Collector-Base Breakdown Voltage ($I_C = 100\text{ }\mu\text{A}$, $I_E = 0$)	$V_{(BR)CBO}$	30	-	-	Vdc
Emitter-Base Breakdown Voltage ($I_E = 10\text{ }\mu\text{A}$, $I_C = 0$)	$V_{(BR)EBO}$	3.0	-	-	Vdc
Collector Cutoff Current ($V_{CB} = 25\text{ Vdc}$, $I_E = 0$)	I_{CBO}	-	-	100	nAdc
Emitter Cutoff Current ($V_{EB} = 2.0\text{ Vdc}$, $I_C = 0$)	I_{EBO}	-	-	100	nAdc

ON CHARACTERISTICS

DC Current Gain ($I_C = 4.0\text{ mA}$, $V_{CE} = 10\text{ Vdc}$) MMBTH10LT1G, NSVMMBTH10LT1G MMBTH10-4LT1G, SMMBTH10-4LT3G	h_{FE}	60 120	- -	- 240	-
Collector-Emitter Saturation Voltage ($I_C = 4.0\text{ mA}$, $I_E = 0.4\text{ mA}$)	$V_{CE(sat)}$	-	-	0.5	Vdc
Base-Emitter On Voltage ($I_C = 4.0\text{ mA}$, $V_{CE} = 10\text{ Vdc}$)	V_{BE}	-	-	0.95	Vdc

SMALL-SIGNAL CHARACTERISTICS

Current-Gain – Bandwidth Product ($I_C = 4.0\text{ mA}$, $V_{CE} = 10\text{ Vdc}$, $f = 100\text{ MHz}$) MMBTH10LT1G, NSVMMBTH10LT1G MMBTH10-4LT1G, SMMBTH10-4LT3G	f_T	650 800	- -	- -	MHz
Collector-Base Capacitance ($V_{CB} = 10\text{ Vdc}$, $I_E = 0$, $f = 1.0\text{ MHz}$)	C_{cb}	-	-	0.7	pF
Common-Base Feedback Capacitance ($V_{CB} = 10\text{ Vdc}$, $I_E = 0$, $f = 1.0\text{ MHz}$)	C_{rb}	-	-	0.65	pF
Collector Base Time Constant ($I_C = 4.0\text{ mA}$, $V_{CB} = 10\text{ Vdc}$, $f = 31.8\text{ MHz}$)	$r_b'C_c$	-	-	9.0	ps

Product parametric performance is indicated in the Electrical Characteristics for the listed test conditions, unless otherwise noted. Product performance may not be indicated by the Electrical Characteristics if operated under different conditions.

TYPICAL CHARACTERISTICS

COMMON-BASE y PARAMETERS versus FREQUENCY

($V_{CB} = 10 \text{ Vdc}$, $I_C = 4.0 \text{ mA dc}$, $T_A = 25^\circ\text{C}$)

y_{ib} , INPUT ADMITTANCE

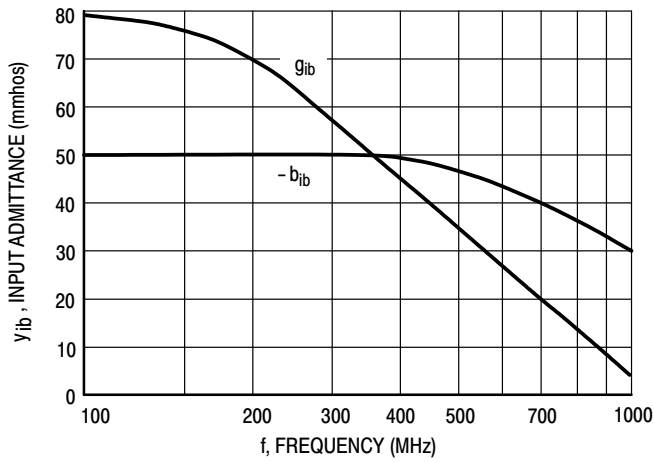

Figure 1. Rectangular Form

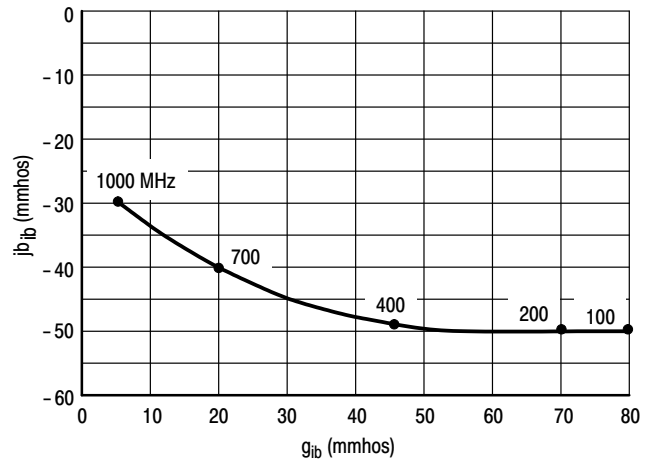

Figure 2. Polar Form

y_{fb} , FORWARD TRANSFER ADMITTANCE

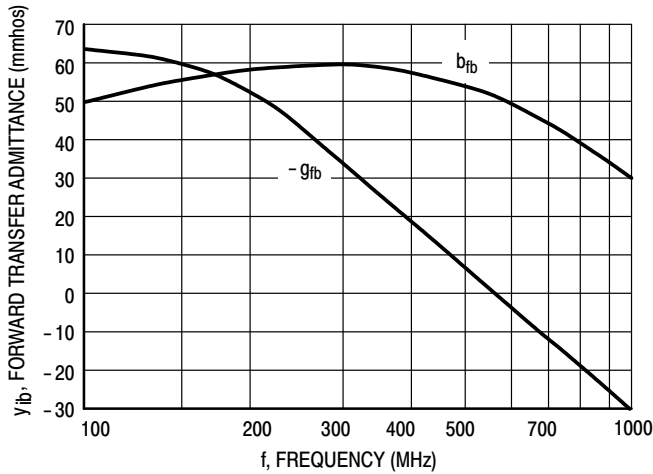

Figure 3. Rectangular Form

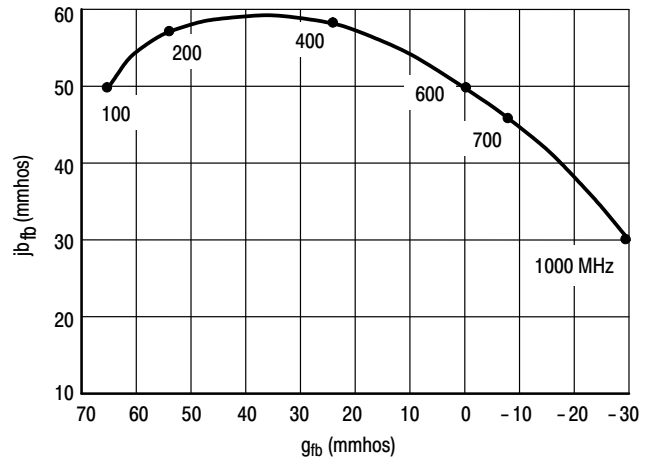

Figure 4. Polar Form

MMBTH10L, MMBTH10-4L, SMMBTH10-4L, NSVMMBTH10L

TYPICAL CHARACTERISTICS

COMMON-BASE y PARAMETERS versus FREQUENCY

($V_{CB} = 10 \text{ Vdc}$, $I_C = 4.0 \text{ mAdc}$, $T_A = 25^\circ\text{C}$)

y_{rb} , REVERSE TRANSFER ADMITTANCE

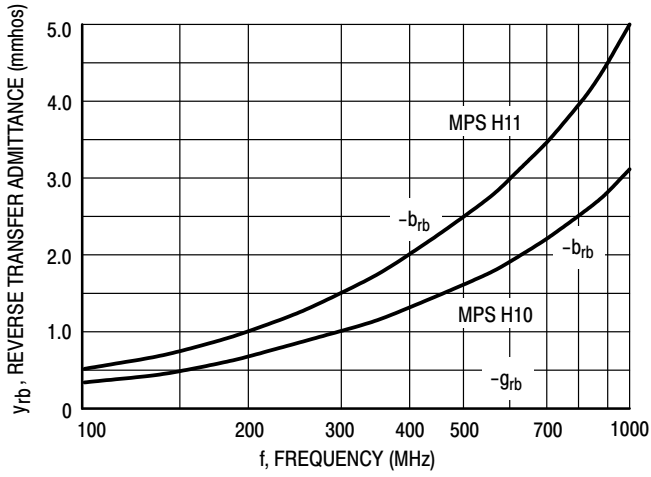

Figure 5. Rectangular Form

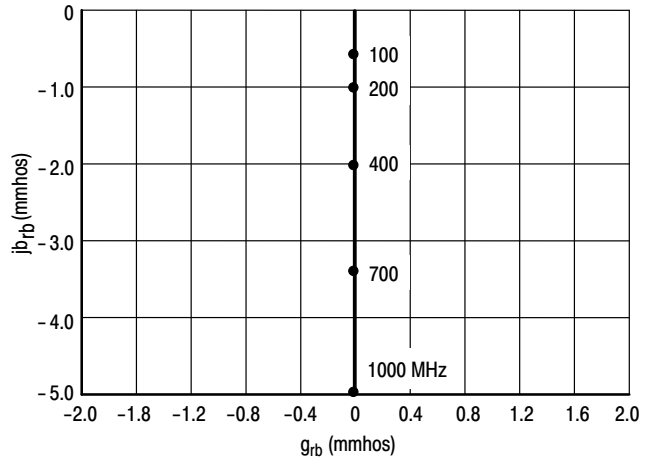

Figure 6. Polar Form

y_{ob} , OUTPUT ADMITTANCE

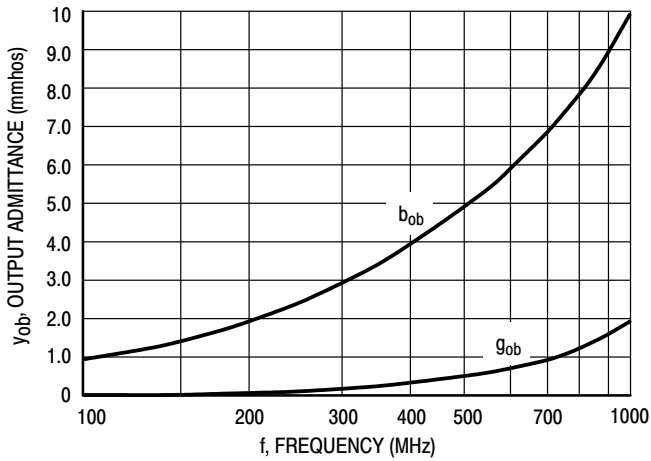

Figure 7. Rectangular Form

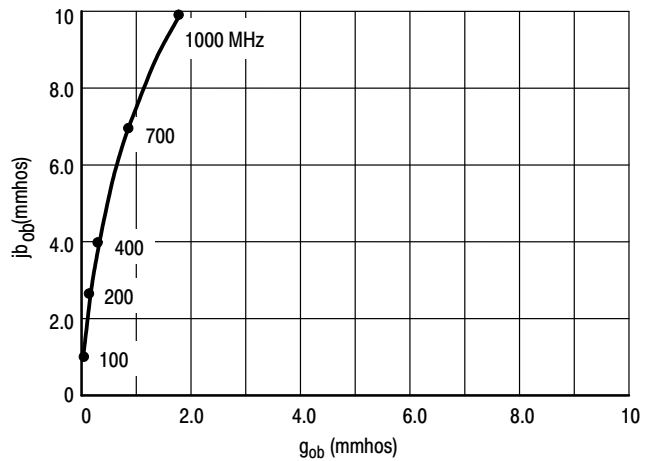
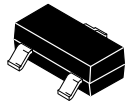

Figure 8. Polar Form

MECHANICAL CASE OUTLINE

PACKAGE DIMENSIONS

ON Semiconductor®



SOT-23 (TO-236)
CASE 318-08
ISSUE AS

DATE 30 JAN 2018

SCALE 4:1

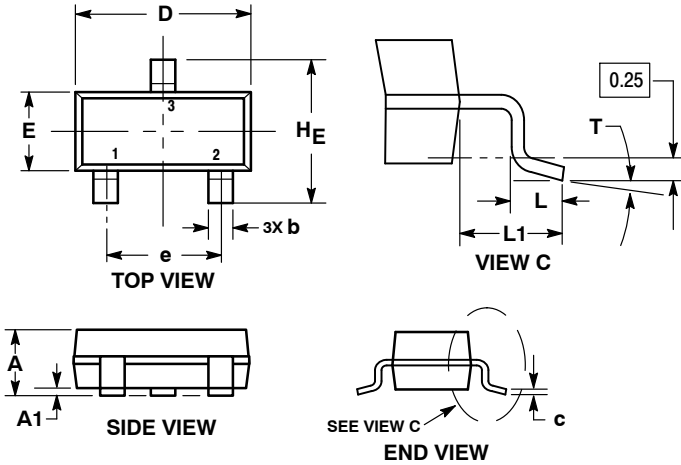

NOTES:

1. DIMENSIONING AND TOLERANCING PER ASME Y14.5M, 1994.
2. CONTROLLING DIMENSION: MILLIMETERS.
3. MAXIMUM LEAD THICKNESS INCLUDES LEAD FINISH. MINIMUM LEAD THICKNESS IS THE MINIMUM THICKNESS OF THE BASE MATERIAL.
4. DIMENSIONS D AND E DO NOT INCLUDE MOLD FLASH, PROTRUSIONS, OR GATE BURRS.

DIM	MILLIMETERS			INCHES		
	MIN	NOM	MAX	MIN	NOM	MAX
A	0.89	1.00	1.11	0.035	0.039	0.044
A1	0.01	0.06	0.10	0.000	0.002	0.004
b	0.37	0.44	0.50	0.015	0.017	0.020
c	0.08	0.14	0.20	0.003	0.006	0.008
D	2.80	2.90	3.04	0.110	0.114	0.120
E	1.20	1.30	1.40	0.047	0.051	0.055
e	1.78	1.90	2.04	0.070	0.075	0.080
L	0.30	0.43	0.55	0.012	0.017	0.022
L1	0.35	0.54	0.69	0.014	0.021	0.027
HE	2.10	2.40	2.64	0.083	0.094	0.104
T	0°	---	10°	0°	---	10°

RECOMMENDED SOLDERING FOOTPRINT

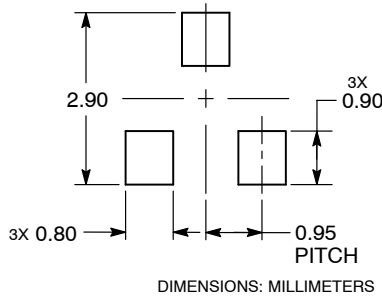

GENERIC MARKING DIAGRAM*

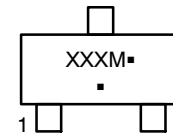

XXX = Specific Device Code
M = Date Code
▪ = Pb-Free Package

*This information is generic. Please refer to device data sheet for actual part marking. Pb-Free indicator, "G" or microdot "▪", may or may not be present.

- | | | | |
|---|---|---|--|
| STYLE 1 THRU 5:
CANCELLED | STYLE 6:
PIN 1. BASE
2. EMITTER
3. COLLECTOR | STYLE 7:
PIN 1. EMITTER
2. BASE
3. COLLECTOR | STYLE 8:
PIN 1. ANODE
2. NO CONNECTION
3. CATHODE |
| STYLE 9:
PIN 1. ANODE
2. ANODE
3. CATHODE | STYLE 10:
PIN 1. DRAIN
2. SOURCE
3. GATE | STYLE 11:
PIN 1. ANODE
2. CATHODE
3. CATHODE-ANODE | STYLE 12:
PIN 1. CATHODE
2. CATHODE
3. ANODE |
| STYLE 13:
PIN 1. SOURCE
2. DRAIN
3. GATE | STYLE 14:
PIN 1. CATHODE
2. GATE
3. ANODE | STYLE 15:
PIN 1. GATE
2. CATHODE
3. ANODE | STYLE 16:
PIN 1. ANODE
2. CATHODE
3. CATHODE |
| STYLE 17:
PIN 1. NO CONNECTION
2. ANODE
3. CATHODE | STYLE 18:
PIN 1. NO CONNECTION
2. CATHODE
3. ANODE | STYLE 19:
PIN 1. CATHODE
2. ANODE
3. CATHODE-ANODE | STYLE 20:
PIN 1. CATHODE
2. ANODE
3. GATE |
| STYLE 21:
PIN 1. GATE
2. SOURCE
3. DRAIN | STYLE 22:
PIN 1. RETURN
2. OUTPUT
3. INPUT | STYLE 23:
PIN 1. ANODE
2. ANODE
3. CATHODE | STYLE 24:
PIN 1. GATE
2. DRAIN
3. SOURCE |
| STYLE 25:
PIN 1. ANODE
2. CATHODE
3. GATE | STYLE 26:
PIN 1. CATHODE
2. ANODE
3. NO CONNECTION | STYLE 27:
PIN 1. CATHODE
2. CATHODE
3. CATHODE | STYLE 28:
PIN 1. ANODE
2. ANODE
3. ANODE |

DOCUMENT NUMBER:	98ASB42226B	Electronic versions are uncontrolled except when accessed directly from the Document Repository. Printed versions are uncontrolled except when stamped "CONTROLLED COPY" in red.
DESCRIPTION:	SOT-23 (TO-236)	PAGE 1 OF 1

ON Semiconductor and ON are trademarks of Semiconductor Components Industries, LLC dba ON Semiconductor or its subsidiaries in the United States and/or other countries. ON Semiconductor reserves the right to make changes without further notice to any products herein. ON Semiconductor makes no warranty, representation or guarantee regarding the suitability of its products for any particular purpose, nor does ON Semiconductor assume any liability arising out of the application or use of any product or circuit, and specifically disclaims any and all liability, including without limitation special, consequential or incidental damages. ON Semiconductor does not convey any license under its patent rights nor the rights of others.