

MUN2232, MMUN2232L, MUN5232, DTC143EE, DTC143EM3, NSBC143EF3

Digital Transistors (BRT) R1 = 4.7 kΩ, R2 = 4.7 kΩ

NPN Transistors with Monolithic Bias Resistor Network

This series of digital transistors is designed to replace a single device and its external resistor bias network. The Bias Resistor Transistor (BRT) contains a single transistor with a monolithic bias network consisting of two resistors; a series base resistor and a base-emitter resistor. The BRT eliminates these individual components by integrating them into a single device. The use of a BRT can reduce both system cost and board space.

Features

- Simplifies Circuit Design
- Reduces Board Space
- Reduces Component Count
- S and NSV Prefix for Automotive and Other Applications Requiring Unique Site and Control Change Requirements; AEC-Q101 Qualified and PPAP Capable
- These Devices are Pb-Free, Halogen Free/BFR Free and are RoHS Compliant

MAXIMUM RATINGS (T_A = 25°C)

Rating	Symbol	Max	Unit
Collector-Base Voltage	V _{CBO}	50	Vdc
Collector-Emitter Voltage	V _{CEO}	50	Vdc
Collector Current – Continuous	I _C	100	mAdc
Input Forward Voltage	V _{IN(fwd)}	30	Vdc
Input Reverse Voltage	V _{IN(rev)}	10	Vdc

Stresses exceeding those listed in the Maximum Ratings table may damage the device. If any of these limits are exceeded, device functionality should not be assumed, damage may occur and reliability may be affected.



ON Semiconductor®

www.onsemi.com

PIN CONNECTIONS

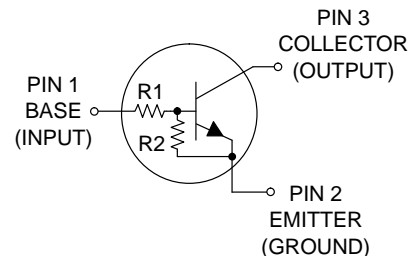

MARKING DIAGRAMS

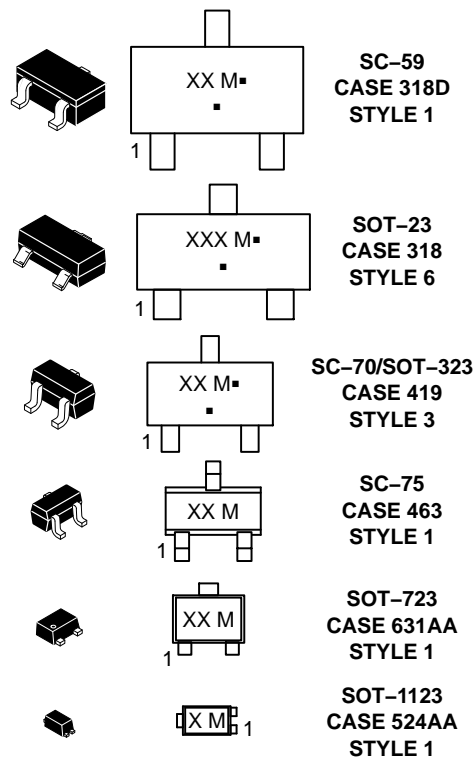

XXX = Specific Device Code
M = Date Code*
▪ = Pb-Free Package

(Note: Microdot may be in either location)

*Date Code orientation may vary depending upon manufacturing location.

ORDERING INFORMATION

See detailed ordering, marking, and shipping information in the package dimensions section on page 2 of this data sheet.

MUN2232, MMUN2232L, MUN5232, DTC143EE, DTC143EM3, NSBC143EF3

Table 1. ORDERING INFORMATION

Device	Part Marking	Package	Shipping†
MUN2232T1G, SMUN2232T1G*	8J	SC-59 (Pb-Free)	3000 / Tape & Reel
MMUN2232LT1G, NSVMMUN2232LT1G*	A8J	SOT-23 (Pb-Free)	3000 / Tape & Reel
NSVMMUN2232LT3G*	A8J	SOT-23 (Pb-Free)	10000 / Tape & Reel
MUN5232T1G, SMUN5232T1G*	8J	SC-70/SOT-323 (Pb-Free)	3000 / Tape & Reel
DTC143EET1G	8J	SC-75 (Pb-Free)	3000 / Tape & Reel
DTC143EM3T5G	8J	SOT-723 (Pb-Free)	8000 / Tape & Reel
NSBC143EF3T5G	P	SOT-1123 (Pb-Free)	8000 / Tape & Reel

†For information on tape and reel specifications, including part orientation and tape sizes, please refer to our Tape and Reel Packaging Specifications Brochure, BRD8011/D.

*S and NSV Prefix for Automotive and Other Applications Requiring Unique Site and Control Change Requirements; AEC-Q101 Qualified and PPAP Capable.

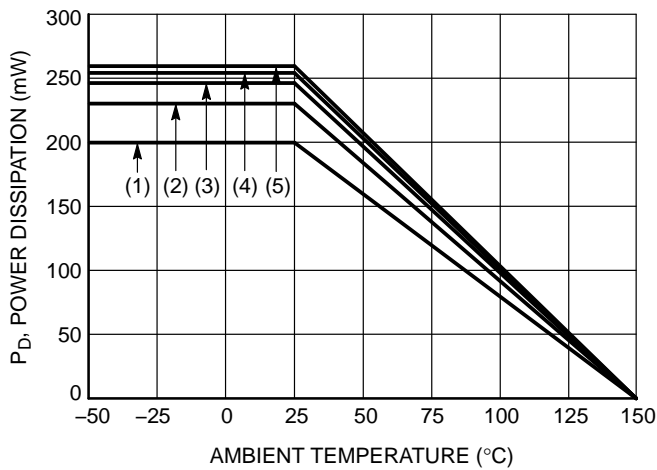

- (1) SC-75 and SC-70/SOT323; Minimum Pad
- (2) SC-59; Minimum Pad
- (3) SOT-23; Minimum Pad
- (4) SOT-1123; 100 mm², 1 oz. copper trace
- (5) SOT-723; Minimum Pad

Figure 1. Derating Curve

MUN2232, MMUN2232L, MUN5232, DTC143EE, DTC143EM3, NSBC143EF3

Table 2. THERMAL CHARACTERISTICS

Characteristic	Symbol	Max	Unit
THERMAL CHARACTERISTICS (SC-59) (MUN2232)			
Total Device Dissipation T _A = 25°C (Note 1) (Note 2) Derate above 25°C (Note 1) (Note 2)	P _D	230 338 1.8 2.7	mW mW/°C
Thermal Resistance, Junction to Ambient (Note 1) (Note 2)	R _{θJA}	540 370	°C/W
Thermal Resistance, Junction to Lead (Note 1) (Note 2)	R _{θJL}	264 287	°C/W
Junction and Storage Temperature Range	T _J , T _{stg}	-55 to +150	°C

THERMAL CHARACTERISTICS (SOT-23) (MMUN2232L)

Total Device Dissipation T _A = 25°C (Note 1) (Note 2) Derate above 25°C (Note 1) (Note 2)	P _D	246 400 2.0 3.2	mW mW/°C
Thermal Resistance, Junction to Ambient (Note 1) (Note 2)	R _{θJA}	508 311	°C/W
Thermal Resistance, Junction to Lead (Note 1) (Note 2)	R _{θJL}	174 208	°C/W
Junction and Storage Temperature Range	T _J , T _{stg}	-55 to +150	°C

THERMAL CHARACTERISTICS (SC-70/SOT-323) (MUN5232)

Total Device Dissipation T _A = 25°C (Note 1) (Note 2) Derate above 25°C (Note 1) (Note 2)	P _D	202 310 1.6 2.5	mW mW/°C
Thermal Resistance, Junction to Ambient (Note 1) (Note 2)	R _{θJA}	618 403	°C/W
Thermal Resistance, Junction to Lead (Note 1) (Note 2)	R _{θJL}	280 332	°C/W
Junction and Storage Temperature Range	T _J , T _{stg}	-55 to +150	°C

THERMAL CHARACTERISTICS (SC-75) (DTC143EE)

Total Device Dissipation T _A = 25°C (Note 1) (Note 2) Derate above 25°C (Note 1) (Note 2)	P _D	200 300 1.6 2.4	mW mW/°C
Thermal Resistance, Junction to Ambient (Note 1) (Note 2)	R _{θJA}	600 400	°C/W
Junction and Storage Temperature Range	T _J , T _{stg}	-55 to +150	°C

THERMAL CHARACTERISTICS (SOT-723) (DTC143EM3)

Total Device Dissipation T _A = 25°C (Note 1) (Note 2) Derate above 25°C (Note 1) (Note 2)	P _D	260 600 2.0 4.8	mW mW/°C
Thermal Resistance, Junction to Ambient (Note 1) (Note 2)	R _{θJA}	480 205	°C/W
Junction and Storage Temperature Range	T _J , T _{stg}	-55 to +150	°C

1. FR-4 @ Minimum Pad.
2. FR-4 @ 1.0 x 1.0 Inch Pad.
3. FR-4 @ 100 mm², 1 oz. copper traces, still air.
4. FR-4 @ 500 mm², 1 oz. copper traces, still air.

MUN2232, MMUN2232L, MUN5232, DTC143EE, DTC143EM3, NSBC143EF3

Table 2. THERMAL CHARACTERISTICS

Characteristic	Symbol	Max	Unit
THERMAL CHARACTERISTICS (SOT-1123) (NSBC143EF3)			
Total Device Dissipation $T_A = 25^\circ\text{C}$ (Note 3) (Note 4) Derate above 25°C (Note 3) (Note 4)	P_D	254 297 2.0 2.4	mW mW/ $^\circ\text{C}$
Thermal Resistance, Junction to Ambient (Note 3) (Note 4)	$R_{\theta JA}$	493 421	$^\circ\text{C/W}$
Thermal Resistance, Junction to Lead (Note 3)	$R_{\theta JL}$	193	$^\circ\text{C/W}$
Junction and Storage Temperature Range	T_J, T_{stg}	-55 to +150	$^\circ\text{C}$

- FR-4 @ Minimum Pad.
- FR-4 @ 1.0 x 1.0 Inch Pad.
- FR-4 @ 100 mm², 1 oz. copper traces, still air.
- FR-4 @ 500 mm², 1 oz. copper traces, still air.

Table 3. ELECTRICAL CHARACTERISTICS ($T_A = 25^\circ\text{C}$, unless otherwise noted)

Characteristic	Symbol	Min	Typ	Max	Unit
OFF CHARACTERISTICS					
Collector-Base Cutoff Current ($V_{CB} = 50\text{ V}, I_E = 0$)	I_{CBO}	-	-	100	nAdc
Collector-Emitter Cutoff Current ($V_{CE} = 50\text{ V}, I_B = 0$)	I_{CEO}	-	-	500	nAdc
Emitter-Base Cutoff Current ($V_{EB} = 6.0\text{ V}, I_C = 0$)	I_{EBO}	-	-	1.5	mAdc
Collector-Base Breakdown Voltage ($I_C = 10\ \mu\text{A}, I_E = 0$)	$V_{(BR)CBO}$	50	-	-	Vdc
Collector-Emitter Breakdown Voltage (Note 5) ($I_C = 2.0\text{ mA}, I_B = 0$)	$V_{(BR)CEO}$	50	-	-	Vdc
ON CHARACTERISTICS					
DC Current Gain (Note 5) ($I_C = 5.0\text{ mA}, V_{CE} = 10\text{ V}$)	h_{FE}	15	30	-	
Collector-Emitter Saturation Voltage (Note 5) ($I_C = 10\text{ mA}, I_B = 1.0\text{ mA}$)	$V_{CE(sat)}$	-	-	0.25	Vdc
Input Voltage (off) ($V_{CE} = 5.0\text{ V}, I_C = 100\ \mu\text{A}$)	$V_{i(off)}$	-	1.2	0.5	Vdc
Input Voltage (on) ($V_{CE} = 0.3\text{ V}, I_C = 20\text{ mA}$)	$V_{i(on)}$	2.5	2.0	-	Vdc
Output Voltage (on) ($V_{CC} = 5.0\text{ V}, V_B = 2.5\text{ V}, R_L = 1.0\text{ k}\Omega$)	V_{OL}	-	-	0.2	Vdc
Output Voltage (off) ($V_{CC} = 5.0\text{ V}, V_B = 0.25\text{ V}, R_L = 1.0\text{ k}\Omega$)	V_{OH}	4.9	-	-	Vdc
Input Resistor	R1	3.3	4.7	6.1	k Ω
Resistor Ratio	R_1/R_2	0.8	1.0	1.2	

Product parametric performance is indicated in the Electrical Characteristics for the listed test conditions, unless otherwise noted. Product performance may not be indicated by the Electrical Characteristics if operated under different conditions.

- Pulsed Condition: Pulse Width = 300 msec, Duty Cycle $\leq 2\%$.

TYPICAL CHARACTERISTICS
 MUN2232, MMUN2232L, MUN5232, DTC143EE, DTC143EM3

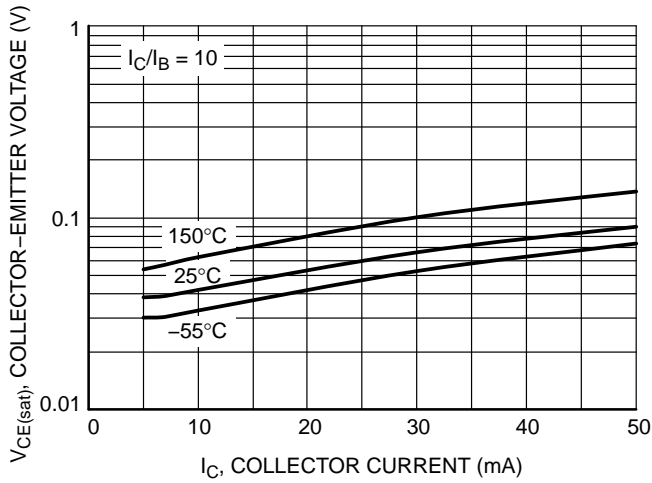

Figure 2. $V_{CE(sat)}$ vs. I_C

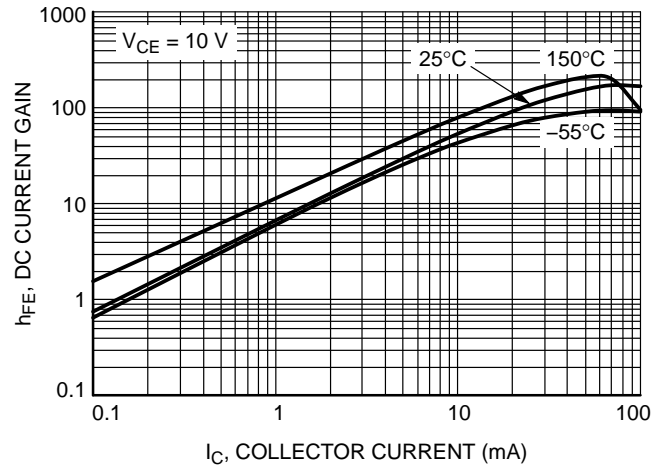

Figure 3. DC Current Gain

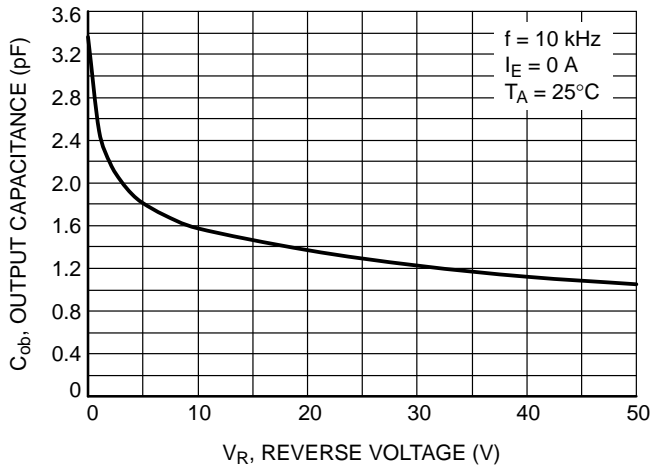

Figure 4. Output Capacitance

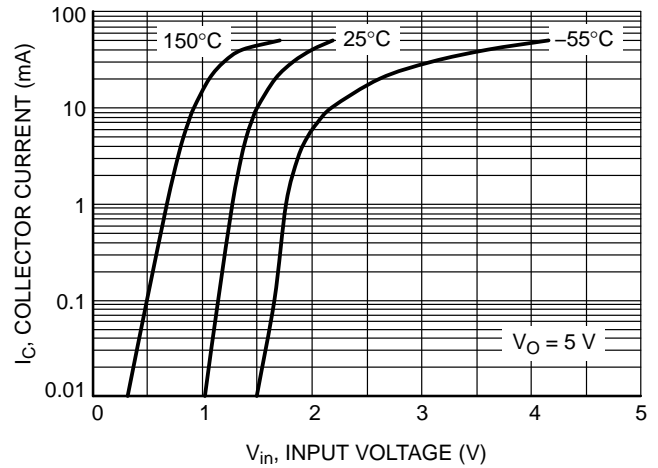

Figure 5. Output Current vs. Input Voltage

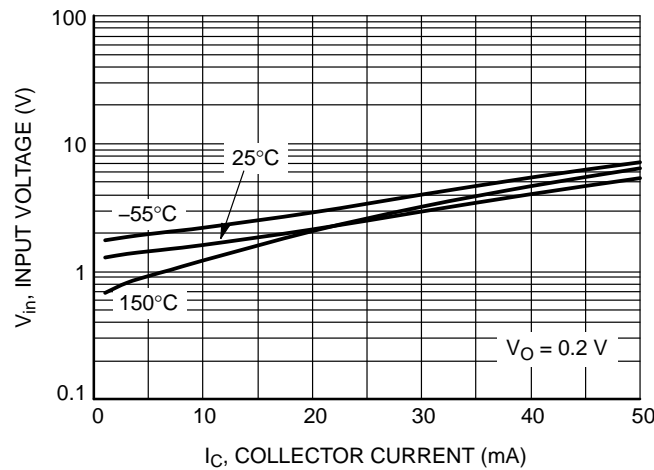

Figure 6. Input Voltage vs. Output Current

TYPICAL CHARACTERISTICS – NSBC143EF3

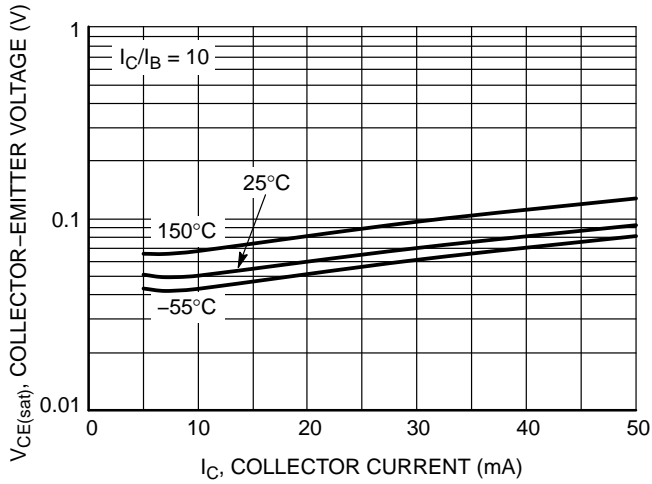

Figure 7. $V_{CE(sat)}$, vs. I_C

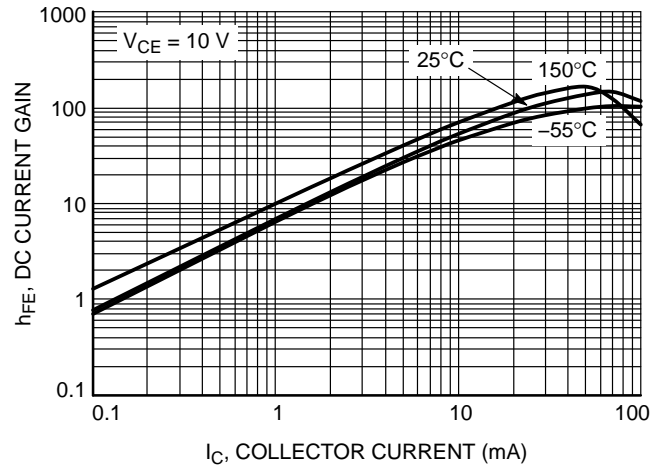

Figure 8. DC Current Gain

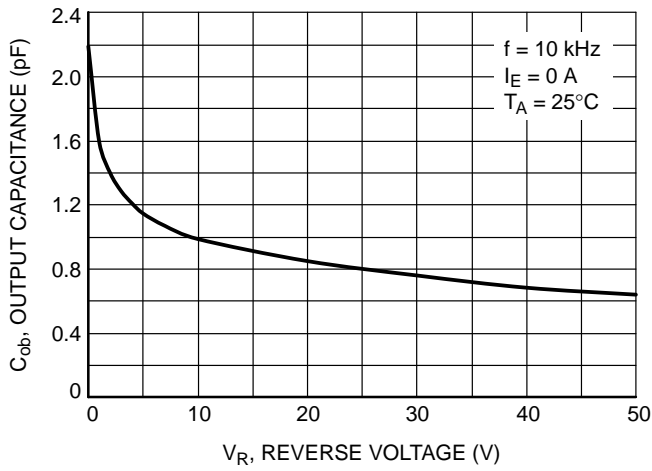

Figure 9. Output Capacitance

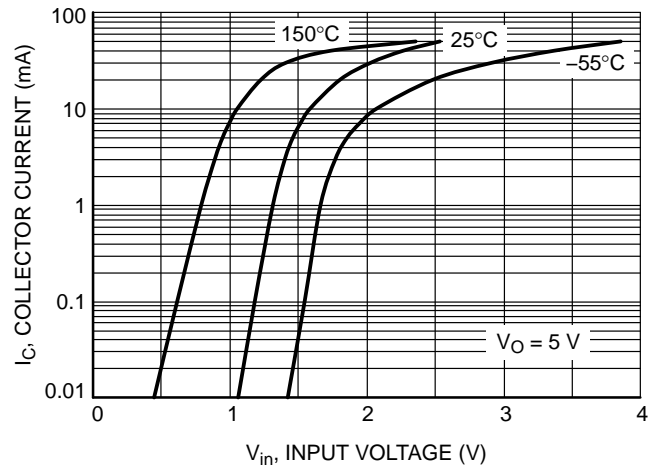

Figure 10. Output Current vs. Input Voltage

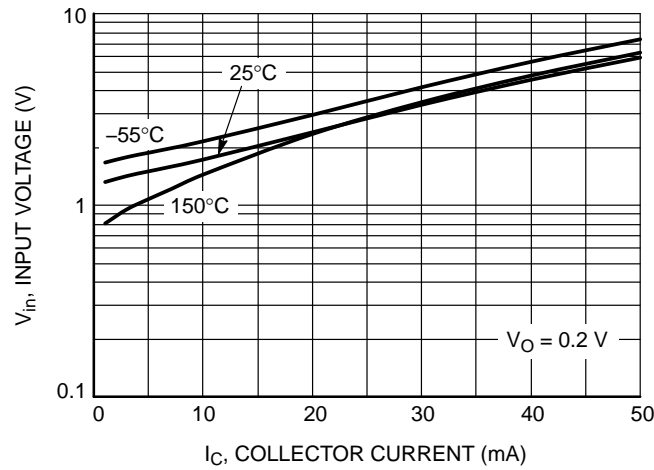
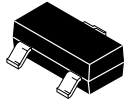

Figure 11. Input Voltage vs. Output Current

MECHANICAL CASE OUTLINE PACKAGE DIMENSIONS



SOT-23 (TO-236)
CASE 318
ISSUE AT

DATE 01 MAR 2023

SCALE 4:1

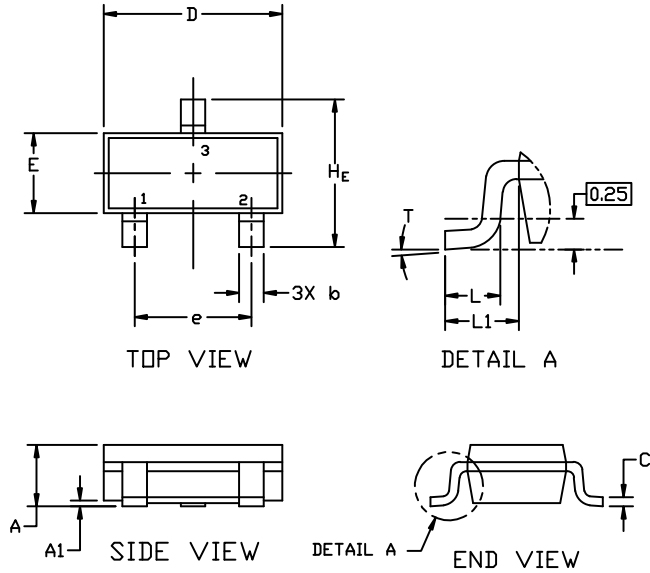

NOTES:

1. DIMENSIONING AND TOLERANCING PER ASME Y14.5M,1994.
2. CONTROLLING DIMENSION: MILLIMETERS
3. MAXIMUM LEAD THICKNESS INCLUDES LEAD FINISH. MINIMUM LEAD THICKNESS IS THE MINIMUM THICKNESS OF THE BASE MATERIAL.
4. DIMENSIONS D AND E DO NOT INCLUDE MOLD FLASH, PROTRUSIONS, OR GATE BURRS.

DIM	MILLIMETERS			INCHES		
	MIN.	NOM.	MAX.	MIN.	NOM.	MAX.
A	0.89	1.00	1.11	0.035	0.039	0.044
A1	0.01	0.06	0.10	0.000	0.002	0.004
b	0.37	0.44	0.50	0.015	0.017	0.020
c	0.08	0.14	0.20	0.003	0.006	0.008
D	2.80	2.90	3.04	0.110	0.114	0.120
E	1.20	1.30	1.40	0.047	0.051	0.055
e	1.78	1.90	2.04	0.070	0.075	0.080
L	0.30	0.43	0.55	0.012	0.017	0.022
L1	0.35	0.54	0.69	0.014	0.021	0.027
H _E	2.10	2.40	2.64	0.083	0.094	0.104
T	0°	---	10°	0°	---	10°

GENERIC MARKING DIAGRAM*

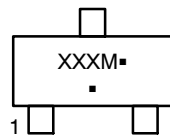

- XXX = Specific Device Code
- M = Date Code
- = Pb-Free Package

*This information is generic. Please refer to device data sheet for actual part marking. Pb-Free indicator, "G" or microdot "▪", may or may not be present. Some products may not follow the Generic Marking.

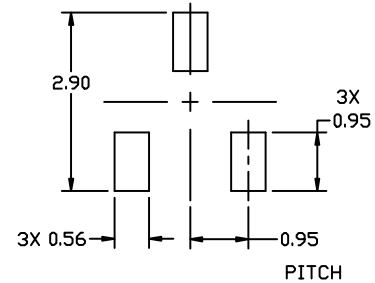

RECOMMENDED MOUNTING FOOTPRINT

* For additional information on our Pb-Free strategy and soldering details, please download the ON Semiconductor Soldering and Mounting Techniques Reference Manual, SOLDERRM/D.

STYLES ON PAGE 2

DOCUMENT NUMBER:	98ASB42226B	Electronic versions are uncontrolled except when accessed directly from the Document Repository. Printed versions are uncontrolled except when stamped "CONTROLLED COPY" in red.
DESCRIPTION:	SOT-23 (TO-236)	PAGE 1 OF 2

onsemi and ONSEMI are trademarks of Semiconductor Components Industries, LLC dba onsemi or its subsidiaries in the United States and/or other countries. onsemi reserves the right to make changes without further notice to any products herein. onsemi makes no warranty, representation or guarantee regarding the suitability of its products for any particular purpose, nor does onsemi assume any liability arising out of the application or use of any product or circuit, and specifically disclaims any and all liability, including without limitation special, consequential or incidental damages. onsemi does not convey any license under its patent rights nor the rights of others.

MECHANICAL CASE OUTLINE

PACKAGE DIMENSIONS



SOT-23 (TO-236) CASE 318 ISSUE AT

DATE 01 MAR 2023

STYLE 1 THRU 5: CANCELLED	STYLE 6: PIN 1. BASE 2. EMITTER 3. COLLECTOR	STYLE 7: PIN 1. EMITTER 2. BASE 3. COLLECTOR	STYLE 8: PIN 1. ANODE 2. NO CONNECTION 3. CATHODE		
STYLE 9: PIN 1. ANODE 2. ANODE 3. CATHODE	STYLE 10: PIN 1. DRAIN 2. SOURCE 3. GATE	STYLE 11: PIN 1. ANODE 2. CATHODE 3. CATHODE-ANODE	STYLE 12: PIN 1. CATHODE 2. CATHODE 3. ANODE	STYLE 13: PIN 1. SOURCE 2. DRAIN 3. GATE	STYLE 14: PIN 1. CATHODE 2. GATE 3. ANODE
STYLE 15: PIN 1. GATE 2. CATHODE 3. ANODE	STYLE 16: PIN 1. ANODE 2. CATHODE 3. CATHODE	STYLE 17: PIN 1. NO CONNECTION 2. ANODE 3. CATHODE	STYLE 18: PIN 1. NO CONNECTION 2. CATHODE 3. ANODE	STYLE 19: PIN 1. CATHODE 2. ANODE 3. CATHODE-ANODE	STYLE 20: PIN 1. CATHODE 2. ANODE 3. GATE
STYLE 21: PIN 1. GATE 2. SOURCE 3. DRAIN	STYLE 22: PIN 1. RETURN 2. OUTPUT 3. INPUT	STYLE 23: PIN 1. ANODE 2. ANODE 3. CATHODE	STYLE 24: PIN 1. GATE 2. DRAIN 3. SOURCE	STYLE 25: PIN 1. ANODE 2. CATHODE 3. GATE	STYLE 26: PIN 1. CATHODE 2. ANODE 3. NO CONNECTION
STYLE 27: PIN 1. CATHODE 2. CATHODE 3. CATHODE	STYLE 28: PIN 1. ANODE 2. ANODE 3. ANODE				

DOCUMENT NUMBER:	98ASB42226B	Electronic versions are uncontrolled except when accessed directly from the Document Repository. Printed versions are uncontrolled except when stamped "CONTROLLED COPY" in red.
DESCRIPTION:	SOT-23 (TO-236)	PAGE 2 OF 2

onsemi and **ONSEMI** are trademarks of Semiconductor Components Industries, LLC dba **onsemi** or its subsidiaries in the United States and/or other countries. **onsemi** reserves the right to make changes without further notice to any products herein. **onsemi** makes no warranty, representation or guarantee regarding the suitability of its products for any particular purpose, nor does **onsemi** assume any liability arising out of the application or use of any product or circuit, and specifically disclaims any and all liability, including without limitation special, consequential or incidental damages. **onsemi** does not convey any license under its patent rights nor the rights of others.

MECHANICAL CASE OUTLINE PACKAGE DIMENSIONS



SCALE 2:1

SC-59
CASE 318D-04
ISSUE H

DATE 28 JUN 2012

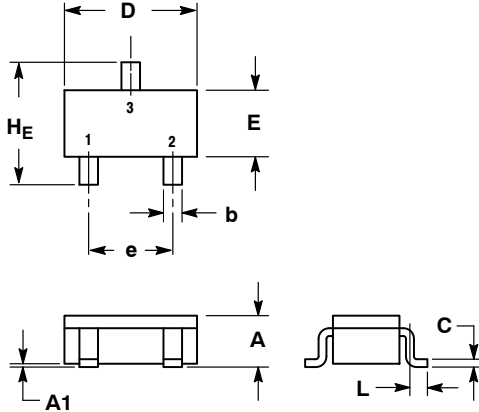

GENERIC MARKING DIAGRAM*

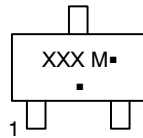

- XXX = Specific Device Code
- M = Date Code
- = Pb-Free Package*

(*Note: Microdot may be in either location)

*This information is generic. Please refer to device data sheet for actual part marking. Pb-Free indicator, "G" or microdot "▪", may or may not be present. Some products may not follow the Generic Marking.

- NOTES:
1. DIMENSIONING AND TOLERANCING PER ANSI Y14.5M, 1982.
2. CONTROLLING DIMENSION: MILLIMETER.

DIM	MILLIMETERS			INCHES		
	MIN	NOM	MAX	MIN	NOM	MAX
A	1.00	1.15	1.30	0.039	0.045	0.051
A1	0.01	0.06	0.10	0.001	0.002	0.004
b	0.35	0.43	0.50	0.014	0.017	0.020
c	0.09	0.14	0.18	0.003	0.005	0.007
D	2.70	2.90	3.10	0.106	0.114	0.122
E	1.30	1.50	1.70	0.051	0.059	0.067
e	1.70	1.90	2.10	0.067	0.075	0.083
L	0.20	0.40	0.60	0.008	0.016	0.024
HE	2.50	2.80	3.00	0.099	0.110	0.118

RECOMMENDED SOLDERING FOOTPRINT*

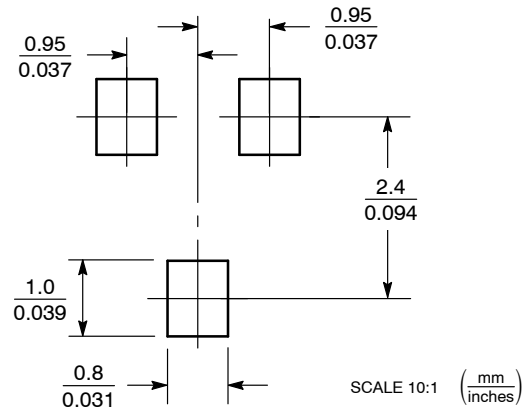

*For additional information on our Pb-Free strategy and soldering details, please download the **onsemi** Soldering and Mounting Techniques Reference Manual, SOLDERRM/D.

- | | | |
|-----------------------------------------------------------------|----------------------------------------------------------------|----------------------------------------------------------------------|
| <p>STYLE 1:
PIN 1. BASE
2. EMITTER
3. COLLECTOR</p> | <p>STYLE 2:
PIN 1. ANODE
2. N.C.
3. CATHODE</p> | <p>STYLE 3:
PIN 1. ANODE
2. ANODE
3. CATHODE</p> |
| <p>STYLE 4:
PIN 1. CATHODE
2. N.C.
3. ANODE</p> | <p>STYLE 5:
PIN 1. CATHODE
2. CATHODE
3. ANODE</p> | <p>STYLE 6:
PIN 1. ANODE
2. CATHODE
3. ANODE/CATHODE</p> |

DOCUMENT NUMBER:	98ASB42664B	Electronic versions are uncontrolled except when accessed directly from the Document Repository. Printed versions are uncontrolled except when stamped "CONTROLLED COPY" in red.
DESCRIPTION:	SC-59	PAGE 1 OF 1

onsemi and **ONSEMI** are trademarks of Semiconductor Components Industries, LLC dba **onsemi** or its subsidiaries in the United States and/or other countries. **onsemi** reserves the right to make changes without further notice to any products herein. **onsemi** makes no warranty, representation or guarantee regarding the suitability of its products for any particular purpose, nor does **onsemi** assume any liability arising out of the application or use of any product or circuit, and specifically disclaims any and all liability, including without limitation special, consequential or incidental damages. **onsemi** does not convey any license under its patent rights nor the rights of others.

MECHANICAL CASE OUTLINE PACKAGE DIMENSIONS

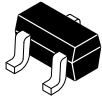

SCALE 4:1

SC-70 (SOT-323) CASE 419 ISSUE R

DATE 11 OCT 2022

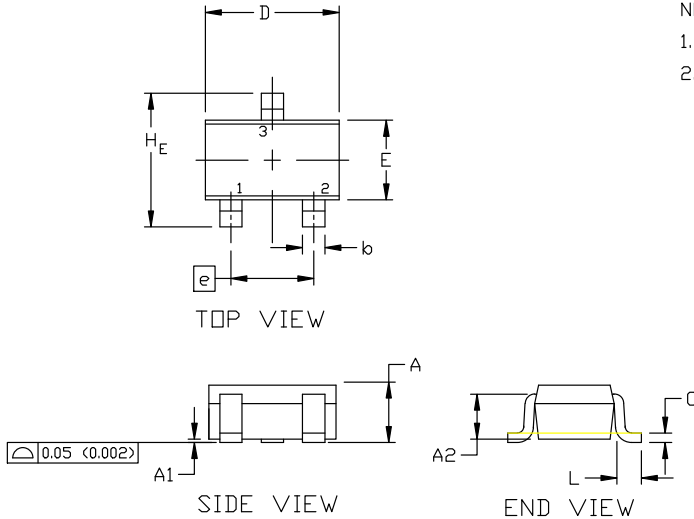

NOTES:

- DIMENSIONING AND TOLERANCING PER ASME Y14.5M, 1982.
- CONTROLLING DIMENSION: INCH

DIM	MILLIMETERS			INCHES		
	MIN.	NOM.	MAX.	MIN.	NOM.	MAX.
A	0.80	0.90	1.00	0.032	0.035	0.040
A1	0.00	0.05	0.10	0.000	0.002	0.004
A2	0.70 REF			0.028 BSC		
b	0.30	0.35	0.40	0.012	0.014	0.016
c	0.10	0.18	0.25	0.004	0.007	0.010
D	1.80	2.00	2.20	0.071	0.080	0.087
E	1.15	1.24	1.35	0.045	0.049	0.053
e	1.20	1.30	1.40	0.047	0.051	0.055
e1	0.65 BSC			0.026 BSC		
L	0.20	0.38	0.56	0.008	0.015	0.022
H _E	2.00	2.10	2.40	0.079	0.083	0.095

GENERIC MARKING DIAGRAM

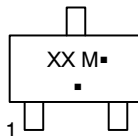

- XX = Specific Device Code
- M = Date Code
- = Pb-Free Package

*This information is generic. Please refer to device data sheet for actual part marking. Pb-Free indicator, "G" or microdot "■", may or may not be present. Some products may not follow the Generic Marking.

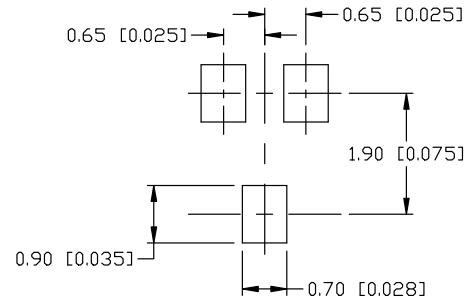

* For additional information on our Pb-Free strategy and soldering details, please download the DN Semiconductor Soldering and Mounting Techniques Reference Manual, SOLDERM/D.

SOLDERING FOOTPRINT

- | | | | | | |
|-------------------------------------------------------|-------------------------------------------------------|-------------------------------------------------------|------------------------------------------------------------|-------------------------------------------------------------|---------------------------------------------------------|
| STYLE 1:
CANCELLED | STYLE 2:
PIN 1. ANODE
2. N.C.
3. CATHODE | STYLE 3:
PIN 1. BASE
2. EMITTER
3. COLLECTOR | STYLE 4:
PIN 1. CATHODE
2. CATHODE
3. ANODE | STYLE 5:
PIN 1. ANODE
2. ANODE
3. CATHODE | |
| STYLE 6:
PIN 1. EMITTER
2. BASE
3. COLLECTOR | STYLE 7:
PIN 1. BASE
2. EMITTER
3. COLLECTOR | STYLE 8:
PIN 1. GATE
2. SOURCE
3. DRAIN | STYLE 9:
PIN 1. ANODE
2. CATHODE
3. CATHODE-ANODE | STYLE 10:
PIN 1. CATHODE
2. ANODE
3. ANODE-CATHODE | STYLE 11:
PIN 1. CATHODE
2. CATHODE
3. CATHODE |

DOCUMENT NUMBER:	98ASB42819B	Electronic versions are uncontrolled except when accessed directly from the Document Repository. Printed versions are uncontrolled except when stamped "CONTROLLED COPY" in red.
DESCRIPTION:	SC-70 (SOT-323)	PAGE 1 OF 1

onsemi and ONSEMI are trademarks of Semiconductor Components Industries, LLC dba onsemi or its subsidiaries in the United States and/or other countries. onsemi reserves the right to make changes without further notice to any products herein. onsemi makes no warranty, representation or guarantee regarding the suitability of its products for any particular purpose, nor does onsemi assume any liability arising out of the application or use of any product or circuit, and specifically disclaims any and all liability, including without limitation special, consequential or incidental damages. onsemi does not convey any license under its patent rights nor the rights of others.

MECHANICAL CASE OUTLINE PACKAGE DIMENSIONS

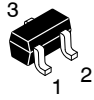

SCALE 4:1

SC-75/SOT-416
CASE 463
ISSUE G

DATE 07 AUG 2015

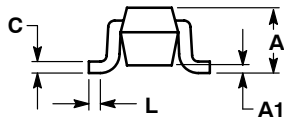
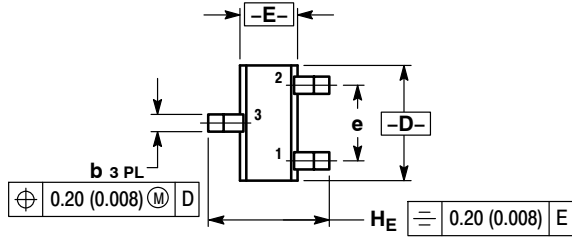

STYLE 1:
PIN 1. BASE
2. EMITTER
3. COLLECTOR

STYLE 2:
PIN 1. ANODE
2. N/C
3. CATHODE

STYLE 3:
PIN 1. ANODE
2. ANODE
3. CATHODE

STYLE 4:
PIN 1. CATHODE
2. CATHODE
3. ANODE

STYLE 5:
PIN 1. GATE
2. SOURCE
3. DRAIN

GENERIC MARKING DIAGRAM*

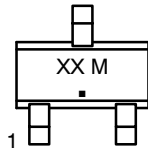

XX = Specific Device Code
M = Date Code
▪ = Pb-Free Package

*This information is generic. Please refer to device data sheet for actual part marking. Pb-Free indicator, "G" or microdot "▪", may or may not be present. Some products may not follow the Generic Marking.

NOTES:

- DIMENSIONING AND TOLERANCING PER ANSI Y14.5M, 1982.
- CONTROLLING DIMENSION: MILLIMETER.

DIM	MILLIMETERS			INCHES		
	MIN	NOM	MAX	MIN	NOM	MAX
A	0.70	0.80	0.90	0.027	0.031	0.035
A1	0.00	0.05	0.10	0.000	0.002	0.004
b	0.15	0.20	0.30	0.006	0.008	0.012
C	0.10	0.15	0.25	0.004	0.006	0.010
D	1.55	1.60	1.65	0.061	0.063	0.065
E	0.70	0.80	0.90	0.027	0.031	0.035
e	1.00 BSC			0.04 BSC		
L	0.10	0.15	0.20	0.004	0.006	0.008
H _E	1.50	1.60	1.70	0.060	0.063	0.067

RECOMMENDED SOLDERING FOOTPRINT*

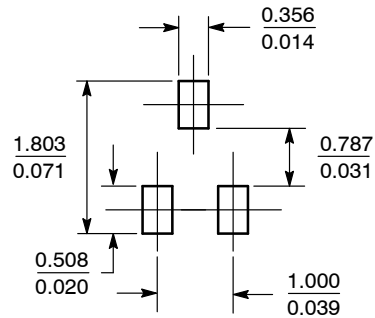

SCALE 10:1 (mm/inches)

*For additional information on our Pb-Free strategy and soldering details, please download the **onsemi** Soldering and Mounting Techniques Reference Manual, SOLDERRM/D.

DOCUMENT NUMBER:	98ASB15184C	Electronic versions are uncontrolled except when accessed directly from the Document Repository. Printed versions are uncontrolled except when stamped "CONTROLLED COPY" in red.
DESCRIPTION:	SC-75/SOT-416	PAGE 1 OF 1

onsemi and ONSEMI are trademarks of Semiconductor Components Industries, LLC dba onsemi or its subsidiaries in the United States and/or other countries. onsemi reserves the right to make changes without further notice to any products herein. onsemi makes no warranty, representation or guarantee regarding the suitability of its products for any particular purpose, nor does onsemi assume any liability arising out of the application or use of any product or circuit, and specifically disclaims any and all liability, including without limitation special, consequential or incidental damages. onsemi does not convey any license under its patent rights nor the rights of others.

MECHANICAL CASE OUTLINE

PACKAGE DIMENSIONS



SCALE 8:1

SOT-1123
CASE 524AA
ISSUE C

DATE 29 NOV 2011

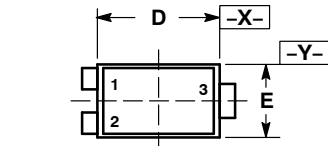

TOP VIEW

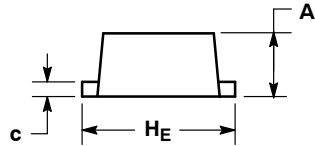

SIDE VIEW

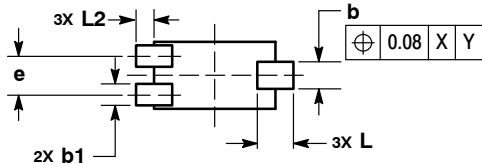

BOTTOM VIEW

NOTES:

1. DIMENSIONING AND TOLERANCING PER ASME Y14.5M, 1994.
2. CONTROLLING DIMENSION: MILLIMETERS.
3. MAXIMUM LEAD THICKNESS INCLUDES LEAD FINISH. MINIMUM LEAD THICKNESS IS THE MINIMUM THICKNESS OF BASE MATERIAL.
4. DIMENSIONS D AND E DO NOT INCLUDE MOLD FLASH, PROTRUSIONS, OR GATE BURRS.

DIM	MILLIMETERS	
	MIN	MAX
A	0.34	0.40
b	0.15	0.28
b1	0.10	0.20
c	0.07	0.17
D	0.75	0.85
E	0.55	0.65
e	0.35	0.40
H _E	0.95	1.05
L	0.185	REF
L2	0.05	0.15

SOLDERING FOOTPRINT*

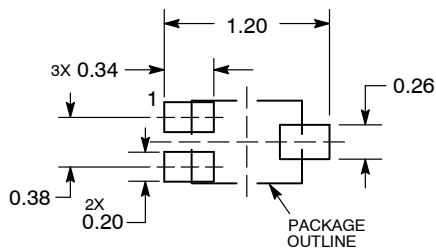

DIMENSIONS: MILLIMETERS

*For additional information on our Pb-Free strategy and soldering details, please download the **onsemi** Soldering and Mounting Techniques Reference Manual, SOLDERRM/D.

GENERIC MARKING DIAGRAM*

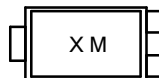

X = Specific Device Code
M = Date Code

*This information is generic. Please refer to device data sheet for actual part marking. Pb-Free indicator, "G" or microdot "μ", may or may not be present. Some products may not follow the Generic Marking.

STYLE 1: PIN 1. BASE 2. EMITTER 3. COLLECTOR	STYLE 2: PIN 1. ANODE 2. N/C 3. CATHODE	STYLE 3: PIN 1. ANODE 2. ANODE 3. CATHODE	STYLE 4: PIN 1. CATHODE 2. CATHODE 3. ANODE	STYLE 5: PIN 1. GATE 2. SOURCE 3. DRAIN
-------------------------------------------------------	--------------------------------------------------	----------------------------------------------------	------------------------------------------------------	--------------------------------------------------

DOCUMENT NUMBER:	98AON23134D	Electronic versions are uncontrolled except when accessed directly from the Document Repository. Printed versions are uncontrolled except when stamped "CONTROLLED COPY" in red.
DESCRIPTION:	SOT-1123, 3-LEAD, 1.0x0.6x0.37, 0.35P	PAGE 1 OF 1

onsemi and **ONSEMI** are trademarks of Semiconductor Components Industries, LLC dba **onsemi** or its subsidiaries in the United States and/or other countries. **onsemi** reserves the right to make changes without further notice to any products herein. **onsemi** makes no warranty, representation or guarantee regarding the suitability of its products for any particular purpose, nor does **onsemi** assume any liability arising out of the application or use of any product or circuit, and specifically disclaims any and all liability, including without limitation special, consequential or incidental damages. **onsemi** does not convey any license under its patent rights nor the rights of others.

MECHANICAL CASE OUTLINE PACKAGE DIMENSIONS



SCALE 4:1

SOT-723
CASE 631AA
ISSUE D

DATE 10 AUG 2009

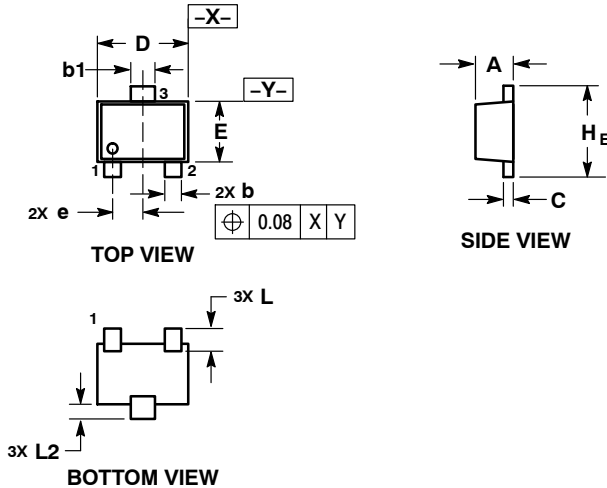

- NOTES:
1. DIMENSIONING AND TOLERANCING PER ASME Y14.5M, 1994.
 2. CONTROLLING DIMENSION: MILLIMETERS.
 3. MAXIMUM LEAD THICKNESS INCLUDES LEAD FINISH. MINIMUM LEAD THICKNESS IS THE MINIMUM THICKNESS OF BASE MATERIAL.
 4. DIMENSIONS D AND E DO NOT INCLUDE MOLD FLASH, PROTRUSIONS OR GATE BURRS.

DIM	MILLIMETERS		
	MIN	NOM	MAX
A	0.45	0.50	0.55
b	0.15	0.21	0.27
b1	0.25	0.31	0.37
C	0.07	0.12	0.17
D	1.15	1.20	1.25
E	0.75	0.80	0.85
e	0.40 BSC		
H E	1.15	1.20	1.25
L	0.29 REF		
L2	0.15	0.20	0.25

RECOMMENDED SOLDERING FOOTPRINT*

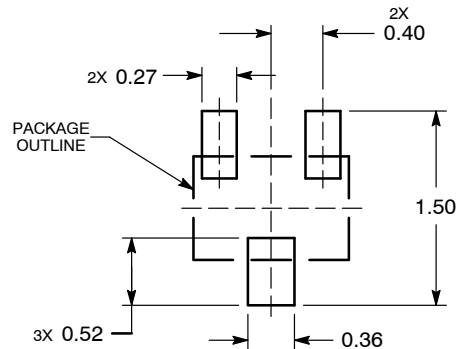

DIMENSIONS: MILLIMETERS

GENERIC MARKING DIAGRAM*

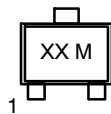

XX = Specific Device Code
M = Date Code

*This information is generic. Please refer to device data sheet for actual part marking. Pb-Free indicator, "G" or microdot "•", may or may not be present. Some products may not follow the Generic Marking.

*For additional information on our Pb-Free strategy and soldering details, please download the **onsemi** Soldering and Mounting Techniques Reference Manual, SOLDERRM/D.

- | | | | | |
|-------------------------------------------------------|--------------------------------------------------|----------------------------------------------------|------------------------------------------------------|--------------------------------------------------|
| STYLE 1:
PIN 1. BASE
2. EMITTER
3. COLLECTOR | STYLE 2:
PIN 1. ANODE
2. N/C
3. CATHODE | STYLE 3:
PIN 1. ANODE
2. ANODE
3. CATHODE | STYLE 4:
PIN 1. CATHODE
2. CATHODE
3. ANODE | STYLE 5:
PIN 1. GATE
2. SOURCE
3. DRAIN |
|-------------------------------------------------------|--------------------------------------------------|----------------------------------------------------|------------------------------------------------------|--------------------------------------------------|

DOCUMENT NUMBER:	98AON12989D	Electronic versions are uncontrolled except when accessed directly from the Document Repository. Printed versions are uncontrolled except when stamped "CONTROLLED COPY" in red.
DESCRIPTION:	SOT-723	PAGE 1 OF 1

onsemi and **ONSEMI** are trademarks of Semiconductor Components Industries, LLC dba **onsemi** or its subsidiaries in the United States and/or other countries. **onsemi** reserves the right to make changes without further notice to any products herein. **onsemi** makes no warranty, representation or guarantee regarding the suitability of its products for any particular purpose, nor does **onsemi** assume any liability arising out of the application or use of any product or circuit, and specifically disclaims any and all liability, including without limitation special, consequential or incidental damages. **onsemi** does not convey any license under its patent rights nor the rights of others.