

DATA SHEET

NTC THERMISTOR HIGH SURGE INRUSH CURRENT LIMITER NT SERIES

RoHS compliant & Halogen free



Product specification— October 26, 2020 V.0



NTC Thermistor NT series Data Sheet

Features

- Effectively restrain surge
- Low power loss under the stable state
- Over-current wide control range and fast response
- Thermal and electrical characteristics of with stability
- Wide range of electrical specifications
- RoHS& Halogen Free (HF) compliant
- Safety certification-UL / TUV

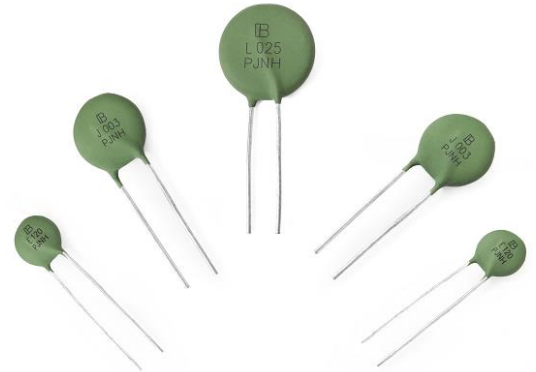

Applications

- Monitor, Sps, Fax, Telecom, Adaptor etc.
- Power supply, Communications equipment etc.

Part Number Code

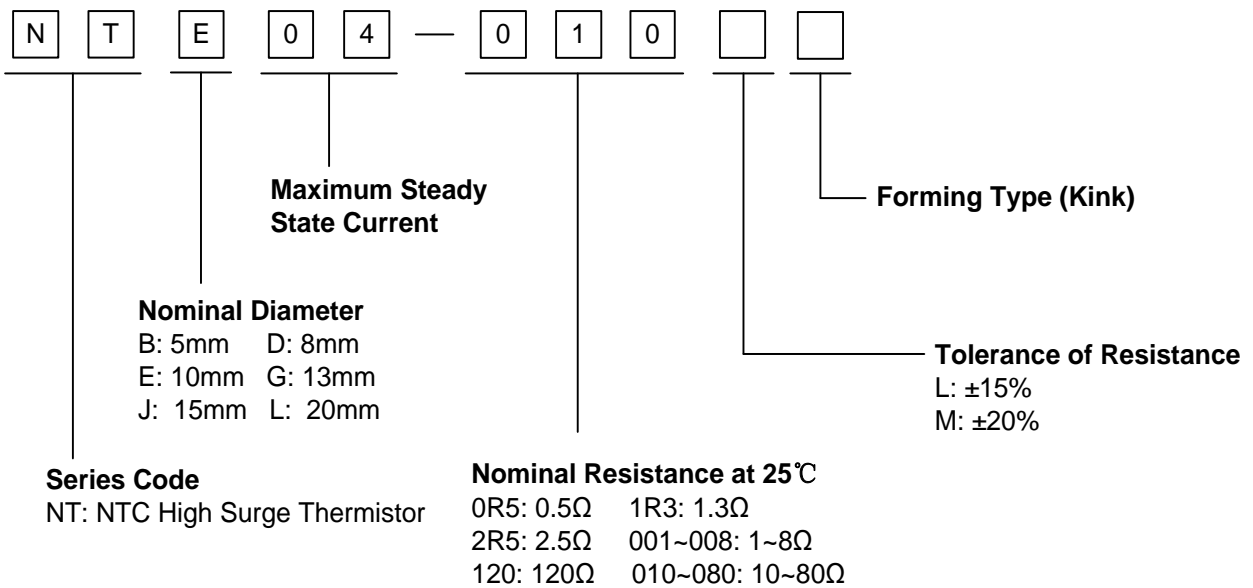

Marking

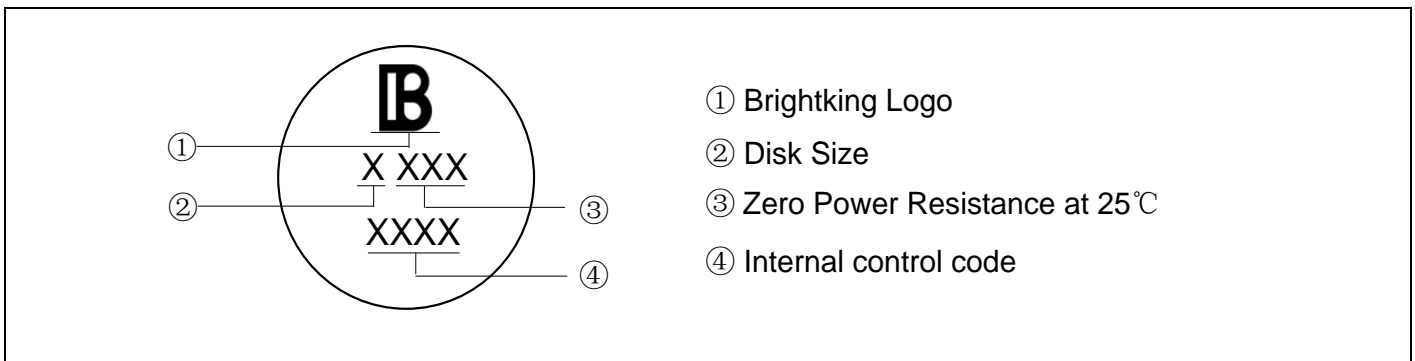

Dimensions (Unit: mm)

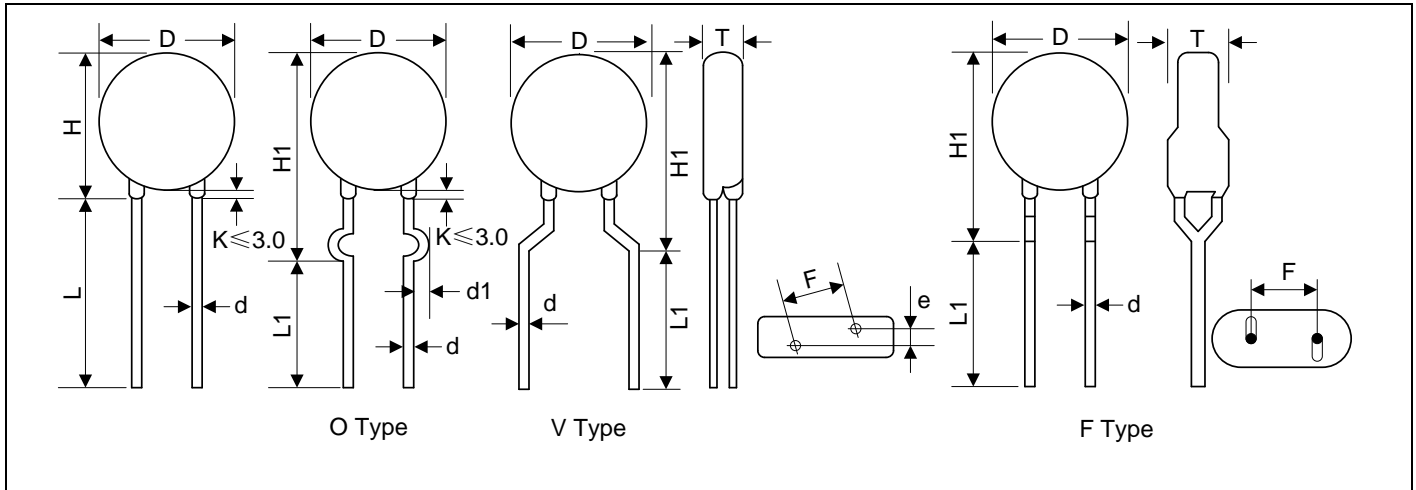

Disc Φ	D (max.)	H (max.)	H1 (max.)	L (Min.)	L1 (Min.)	d (± 0.02)	d1 (± 0.4)	T (max.)	F (± 0.8)	e (± 0.5)	Lead Shape Type			
5(B)	7.5	/	10.5	/	15	0.60	1.4	5.0	5.0	1.6	/	/	/	v
8(D)	11.0	13.5	14.0	20.0	15	0.80	1.4	6.0	5.0	2.0	Straight	O	F	/
10(E)	13.5	16.0	18.0	20.0	15	0.80	1.4	6.0	5.0	2.1	Straight	O	F	/
13(G)	16.0	19.0	22.0	20.0	15	1.00	1.6	6.0	7.5	2.9	Straight	O	F	/
15(J)	18.0	21.0	25.0	20.0	15	1.00	1.6	6.5	7.5	3.1	Straight	O	F	/
20(L)	24.0	28.0	33.0	20.0	15	1.00	1.6	7.5	7.5	3.6	Straight	O	F	/

Remarks: The default lead shape for 8 Φ (NTD) ~20 Φ (NTL) products is Straight lead shape.

"V" type is only for 5 Φ (NTB) products.

Maximum Power Rating

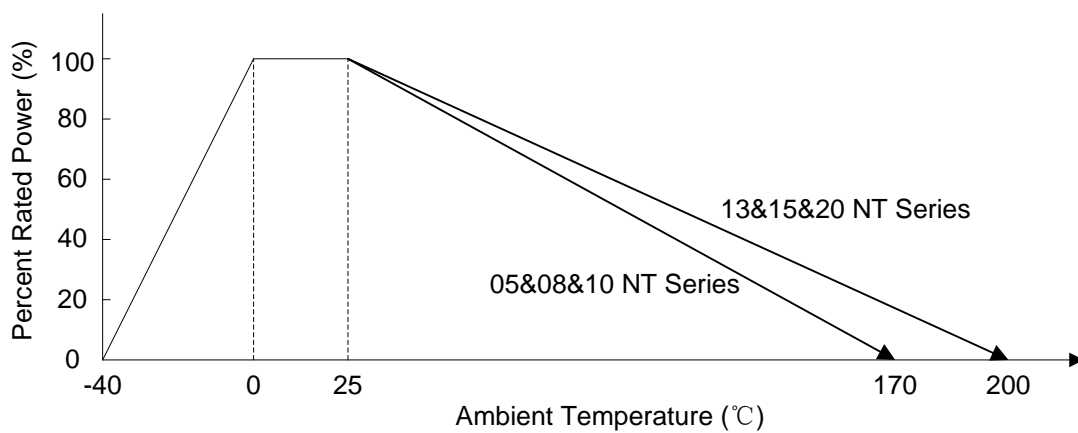

NTC Inrush Current Limiter

NT series

Electrical Characteristics

Nominal Diameter (mm)	Part Number	Zero Power Resistance at 25°C	Maximum Steady State Current at 25°C	Residual Resistance at 25°C I _{max} R _{lmax}	Typical value		Recommend Capacitance 240Vac	Maximum Steady Power	Operating Temperature Range	UL	TUV
					Thermal Time Constant	Thermal Dissipation Constant					
					(s)	(mW/°C)					
5(B)	NTB02-005□	5	2	0.325	35	7	60	1.5	-40~+170	V	V
	NTB01-010□	10	1	1.116	35	7	60	1.5	-40~+170	V	V
	NTB02-006□	6	2	0.350	35	7	60	1.5	-40~+170	V	V
	NTB02-007□	7	2	0.375	35	7	60	1.5	-40~+170	V	V
	NTB02-008□	8	2	0.400	35	7	60	1.5	-40~+170	V	V
	NTB02-009□	9	2	0.425	35	7	60	1.5	-40~+170	V	V
	NTB02-010□	10	2	0.450	35	7	60	1.5	-40~+170	V	V
	NTB01-012□	12	1	1.250	35	7	60	1.5	-40~+170	V	V
	NTBR25-045□	45	0.25	7.720	35	7	40	1.5	-40~+170	V	V
8(D)	NTD04-003□	3	4	0.150	48	12	220	2.3	-40~+170	V	V
	NTD04-004□	4	4	0.166	48	12	220	2.3	-40~+170	V	V
	NTD04-005□	5	4	0.182	48	9	220	2.3	-40~+170	V	V
	NTD04-006□	6	4	0.191	48	9	220	2.3	-40~+170	V	V
	NTD03-007□	7	3	0.195	48	9	220	2.3	-40~+170	V	/
	NTD03-008□	8	3	0.278	45	12	220	2.3	-40~+170	V	V
	NTD03-009□	9	3	0.283	45	12	220	2.3	-40~+170	V	V
	NTD03-010□	10	3	0.288	45	12	220	2.3	-40~+170	V	V
10(E)	NTE05-001□	1	5	0.082	59	12	330	2.5	-40~+170	V	V
	NTE05-002□	2	5	0.094	59	12	330	2.5	-40~+170	V	V
	NTE05-003□	3	5	0.098	59	12	330	2.5	-40~+170	V	V
	NTE04-005□	5	4	0.152	59	12	330	2.5	-40~+170	V	V
	NTE04-006□	6	4	0.166	59	12	330	2.5	-40~+170	V	V
	NTE04-007□	7	3	0.180	59	12	330	2.5	-40~+170	V	/
	NTE04-008□	8	4	0.194	59	12	330	2.5	-40~+170	V	V
	NTE04-009□	9	4	0.195	59	12	330	2.5	-40~+170	V	V
	NTE04-010□	10	4	0.196	59	12	330	2.5	-40~+170	V	V
	NTE03-011□	11	3	0.293	58	11	270	2.5	-40~+170	V	V
	NTE03-012□	12	3	0.296	58	11	270	2.5	-40~+170	V	V
	NTE03-013□	13	3	0.299	58	11	270	2.5	-40~+170	V	V
	NTE03-014□	14	3	0.302	58	11	270	2.5	-40~+170	V	V
	NTE03-015□	15	3	0.305	62	11	270	2.5	-40~+170	V	V
	NTE03-016□	16	3	0.308	62	11	270	2.5	-40~+170	V	V
	NTE03-017□	17	3	0.311	62	11	270	2.5	-40~+170	V	V
	NTE03-018□	18	3	0.314	62	11	270	2.5	-40~+170	V	V
	NTE03-019□	19	3	0.317	62	11	270	2.5	-40~+170	V	V
	NTE03-020□	20	3	0.320	62	11	270	2.5	-40~+170	V	V
	NTE03-021□	21	3	0.323	62	11	270	2.5	-40~+170	V	V
NTE03-022□	22	3	0.326	62	11	270	2.5	-40~+170	V	V	

NTC Inrush Current Limiter

NT series

Nominal Diameter (mm)	Part Number	Zero Power Resistance at 25°C	Maximum Steady State Current at 25°C	Residual Resistance at 25°C I _{max} R _{Imax}	Typical value		Recommend Capacitance 240Vac	Maximum Steady Power	Operating Temperature Range	U _L	T _{UV}
					Thermal Time Constant	Thermal Dissipation Constant					
					(Ω)	(A)					
13(G)	NTG07-001□	1	7	0.074	85	18	680	3	-40~+200	V	V
	NTG07-002□	2	7	0.074	85	18	680	3	-40~+200	V	V
	NTG07-003□	3	7	0.074	85	18	680	3	-40~+200	V	V
	NTG06-005□	5	6	0.120	93	17	560	3	-40~+200	V	V
	NTG05-006□	6	5	0.163	90	17	560	3	-40~+200	V	V
	NTG05-007□	7	5	0.171	80	19	560	3	-40~+200	V	V
	NTG05-008□	8	5	0.155	91	15	560	3	-40~+200	V	V
	NTG05-009□	9	5	0.163	89	15	560	3	-40~+200	V	V
	NTG05-010□	10	5	0.171	87	14	560	3	-40~+200	V	V
	NTG04-011□	11	4	0.241	87	14	560	3	-40~+200	V	V
	NTG04-012□	12	4	0.243	87	14	560	3	-40~+200	V	V
	NTG04-013□	13	4	0.244	87	14	560	3	-40~+200	V	V
	NTG04-014□	14	4	0.245	87	14	560	3	-40~+200	V	V
	NTG04-015□	15	4	0.247	87	14	560	3	-40~+200	V	V
	NTG04-016□	16	4	0.250	87	15	560	3	-40~+200	V	V
	NTG04-017□	17	4	0.255	87	15	560	3	-40~+200	V	V
	NTG04-018□	18	4	0.260	87	15	560	3	-40~+200	V	V
	NTG04-019□	19	4	0.265	87	15	560	3	-40~+200	V	V
	NTG04-020□	20	4	0.270	87	15	560	3	-40~+200	V	V
	15(J)	NTJ09-001□	1	9	0.051	104	20	1000	4	-40~+200	V
NTJ09-002□		2	9	0.056	104	20	820	4	-40~+200	V	V
NTJ09-2R5□		2.5	9	0.063	104	20	820	4	-40~+200	V	V
NTJ09-003□		3	9	0.059	106	20	820	4	-40~+200	V	V
NTJ08-005□		5	8	0.082	110	20	820	4	-40~+200	V	V
NTJ06-008□		8	6	0.142	99	15	680	4	-40~+200	V	V
NTJ06-009□		9	6	0.143	99	16	680	4	-40~+200	V	V
NTJ06-010□		10	6	0.145	99	19	680	4	-40~+200	V	V
NTJ06-011□		11	6	0.148	99	19	680	4	-40~+200	V	V
NTJ06-012□		12	6	0.149	99	21	680	4	-40~+200	V	V
NTJ06-013□		13	6	0.152	99	19	680	4	-40~+200	V	V
NTJ06-014□		14	6	0.156	99	19	680	4	-40~+200	V	V
NTJ06-015□		15	6	0.159	99	17	680	4	-40~+200	V	V
NTJ04-040□	40	4	0.292	101	20	680	4	-40~+200	V	V	
20(L)	NTL12-0R7□	0.7	12	0.039	160	28	1200	5	-40~+200	V	V
	NTL12-001□	1	12	0.039	160	28	1200	5	-40~+200	V	V
	NTL12-002□	2	12	0.041	160	28	1200	5	-40~+200	V	V
	NTL12-2R5□	2.5	12	0.046	120	24	1200	5	-40~+200	V	V
	NTL12-003□	3	12	0.050	130	24	1200	5	-40~+200	V	V
	NTL10-005□	5	10	0.068	144	24	1200	5	-40~+200	V	V
	NTL10-006□	6	10	0.072	144	24	1200	5	-40~+200	V	V

□ means tolerance of R25 , L: ± 15%, M: ± 20%,

Reliability Test Requirements

Test items Reference standard	Test conditions		Criterion
High Temperature Storage IEC 60068-2-2	T _U ±5℃, 1000±24hrs		No visible damage ΔR25/R25 ≦ 20%
Damp Heat, Steady State IEC 60068-2-78	40±2℃,90~95%RH , 1000±24hrs		No visible damage ΔR25/R25 ≦ 20%
Endurance IEC 60539-1	25±5℃ , I _{max} .1000±24hrs		No visible damage ΔR25/R25 ≦ 20%
Rapid Change of Temperature IEC 60068-2-14	Step	Temperature (℃)	No visible damage ΔR25/R25 ≦ 20%
	1	T _L ± 5	
	2	Room	
	3	T _U ± 5	
	4	Room	
5 Cycles			
Capacitance test standard specifications	25±5℃ , C _{th} , interval 2mins, , Number of cycles: 1000, C _{th} =Capacitance at 340 VDC		No visible damage ΔR25/R25 ≦ 20%
Cyclic endurance IEC 60539-1	25±5℃,I _{max} .1min ON/5min OFF*1000cycles;		No visible damage ΔR25/R25 ≦ 20%
Insulation Test MIL-STD-202F-Method 302	1000 VDC,1min		No visible damage
Tensile Strength of Terminals IEC 60068-2-21	Gradually applying the force specified and keeping the unit fixed for 10±1 sec.		No visible damage ΔR25/R25 ≦ 10 %
	Terminal diameter (mm)	Force (kg)	
	0.5<d ≦ 0.8	1.0	
	0.8<d ≦ 1.25	2.0	
Bending Strength of Terminals IEC60068-2-21	Follow spec: Hold specimen and apply the force specified below to each lead. Bend the specimen to 90°, then return to the original position. Repeat the procedure in the opposite direction.		No visible damage ΔV/V1mA ≦ 5%
	Terminal diameter (mm)	Force (kg)	
	0.5<d ≦ 0.8	0.5	
	0.8<d ≦ 1.25	1.0	
	1.25<d	2.0	
Solderability IEC 60068-2-20	245 ± 3 ℃ , 3 ± 0.3 sec		≧ 95%
Resistance to Soldering Heat IEC 60068-2-20	260 ± 3 ℃ ,10 ± 1 sec		ΔR/R ≦ 5 %

Resistance–Temperature Characteristic Curves

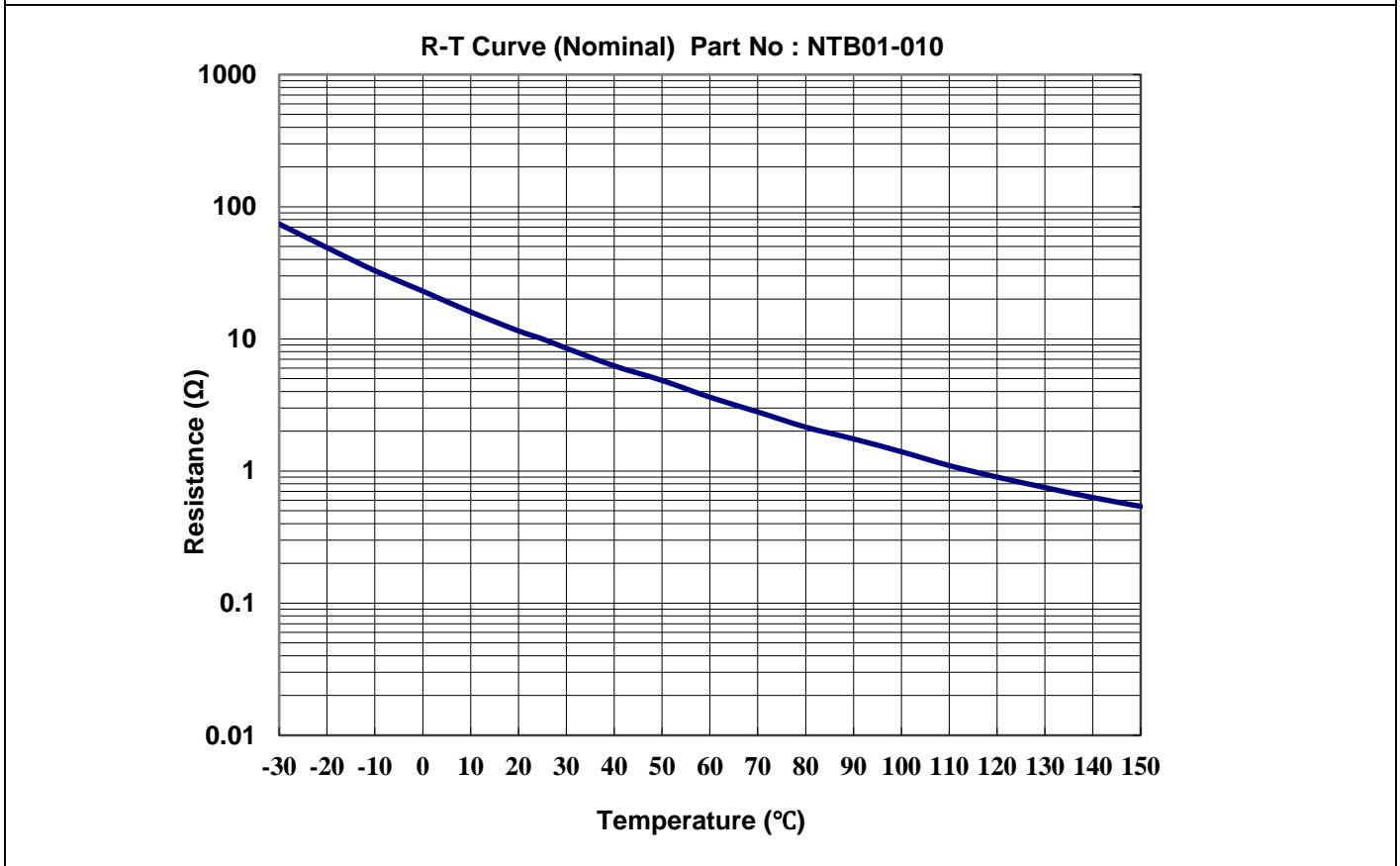
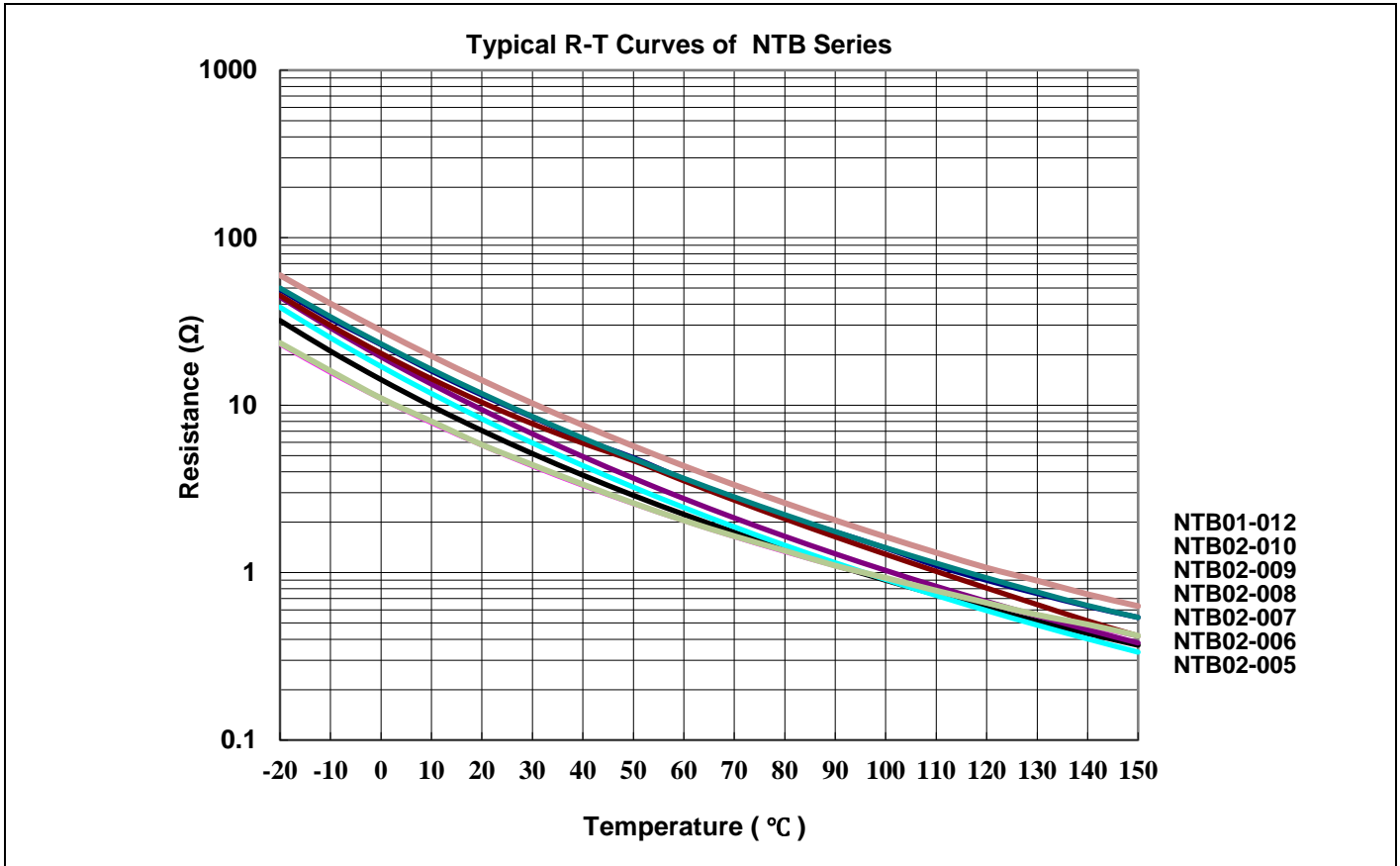

Resistance–Temperature Characteristic Curves

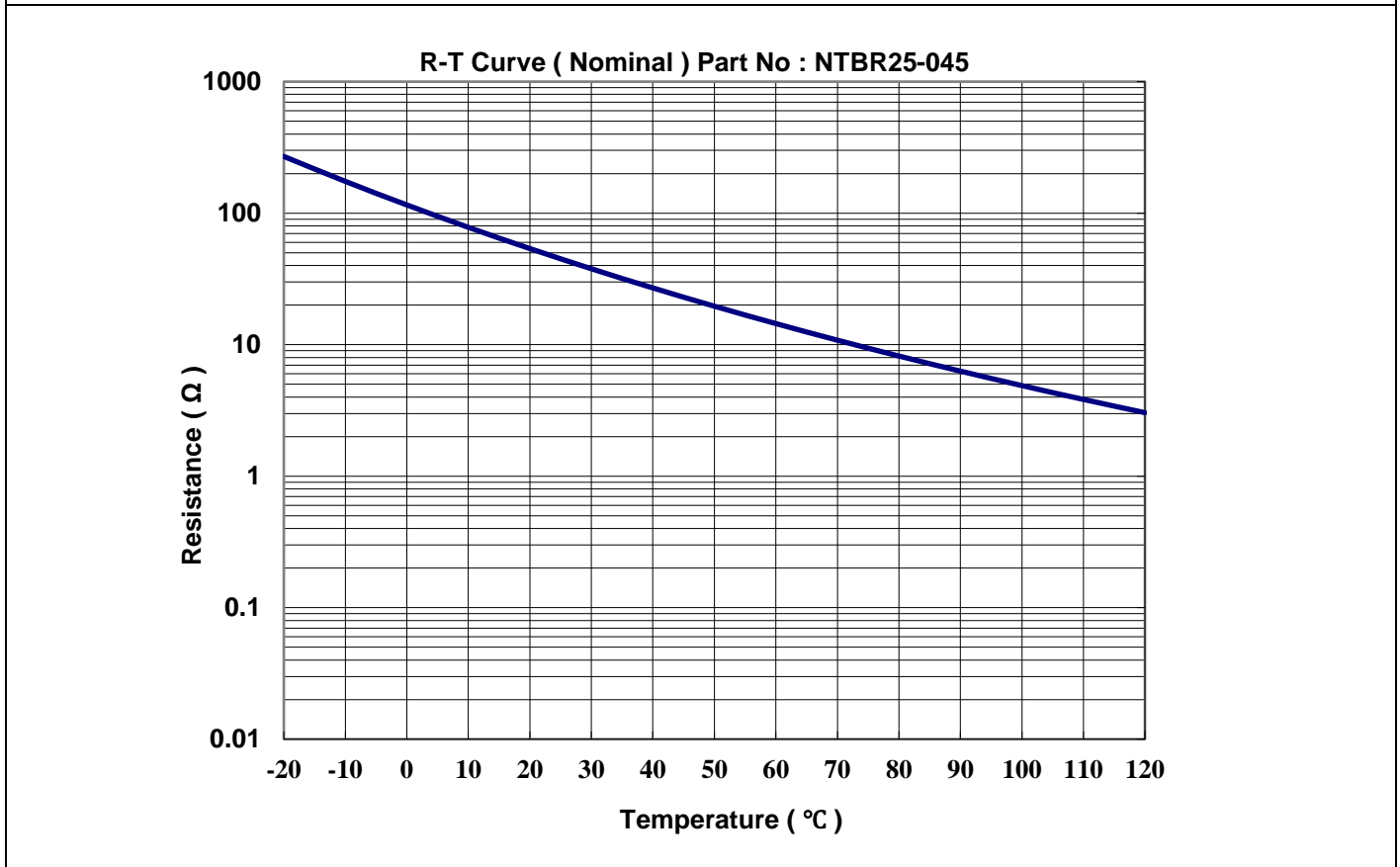
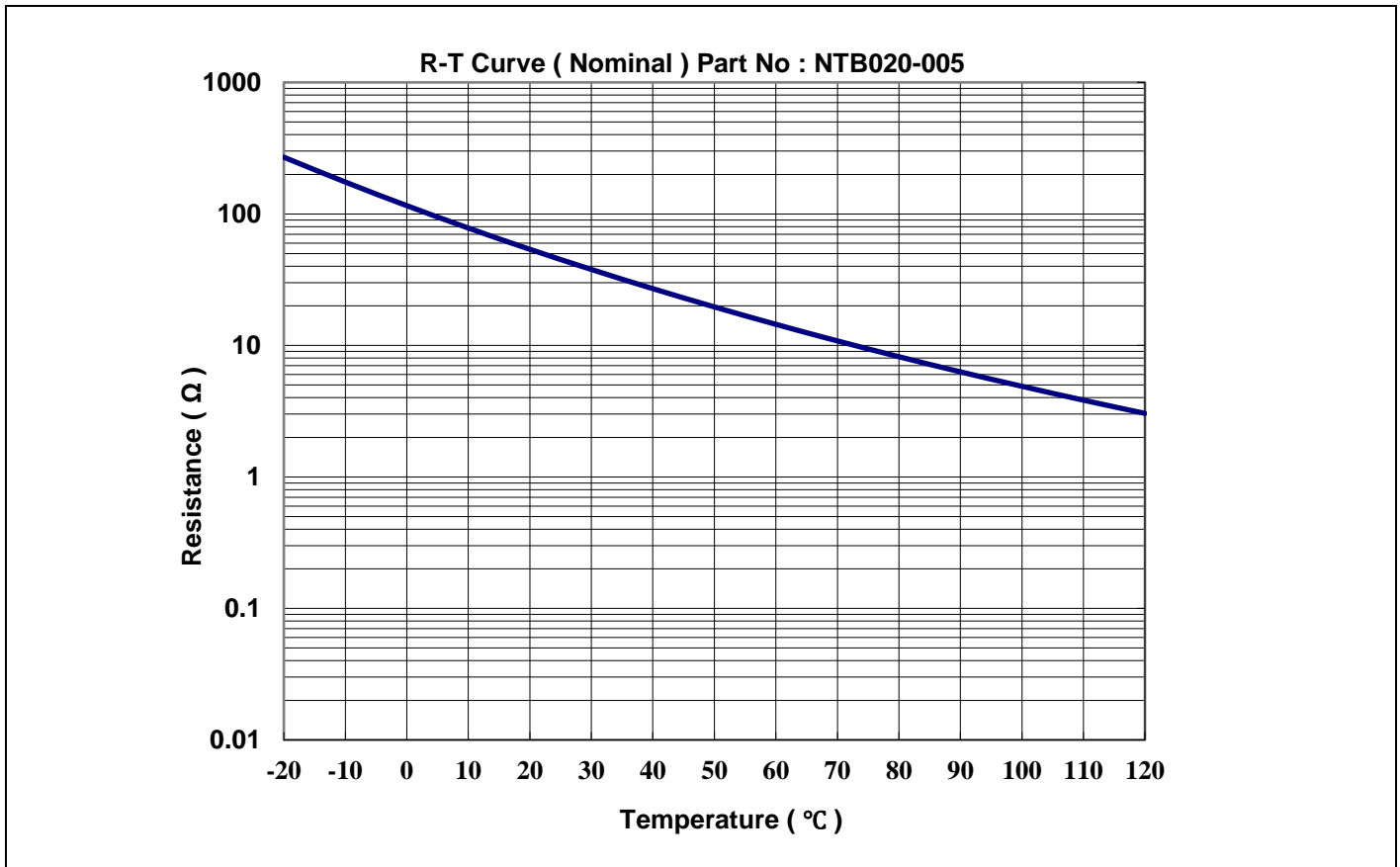

Resistance–Temperature Characteristic Curves

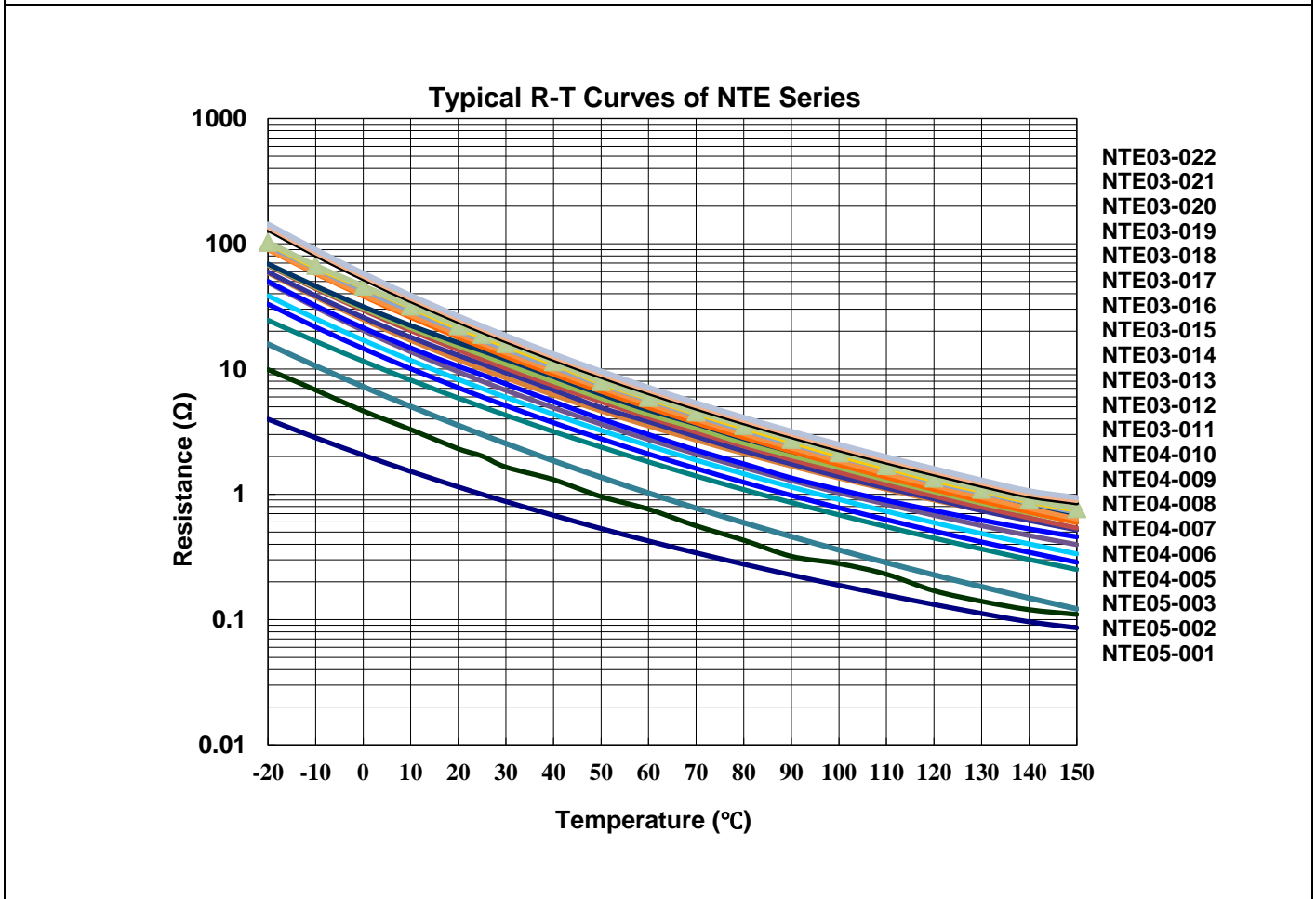
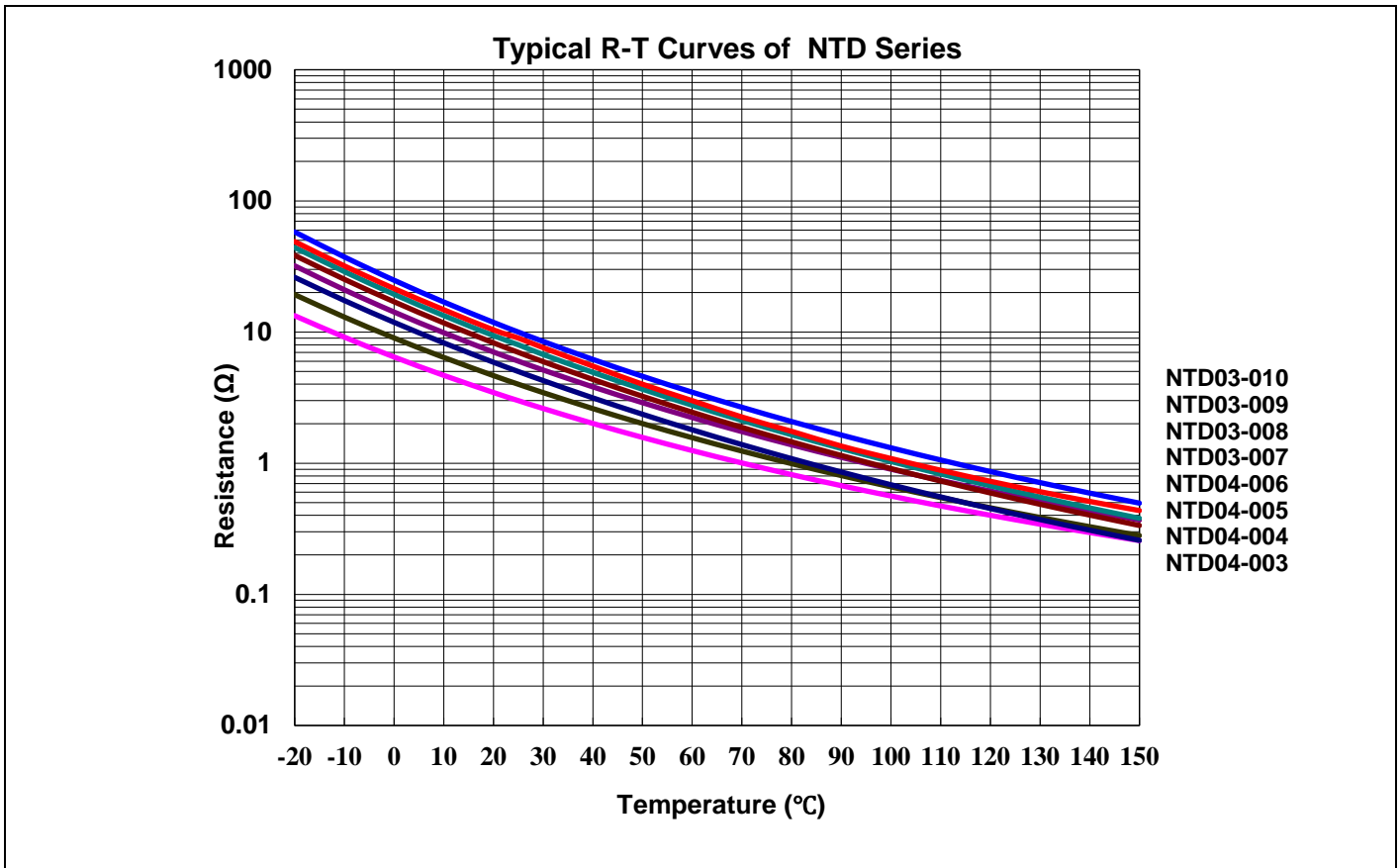

Resistance–Temperature Characteristic Curves

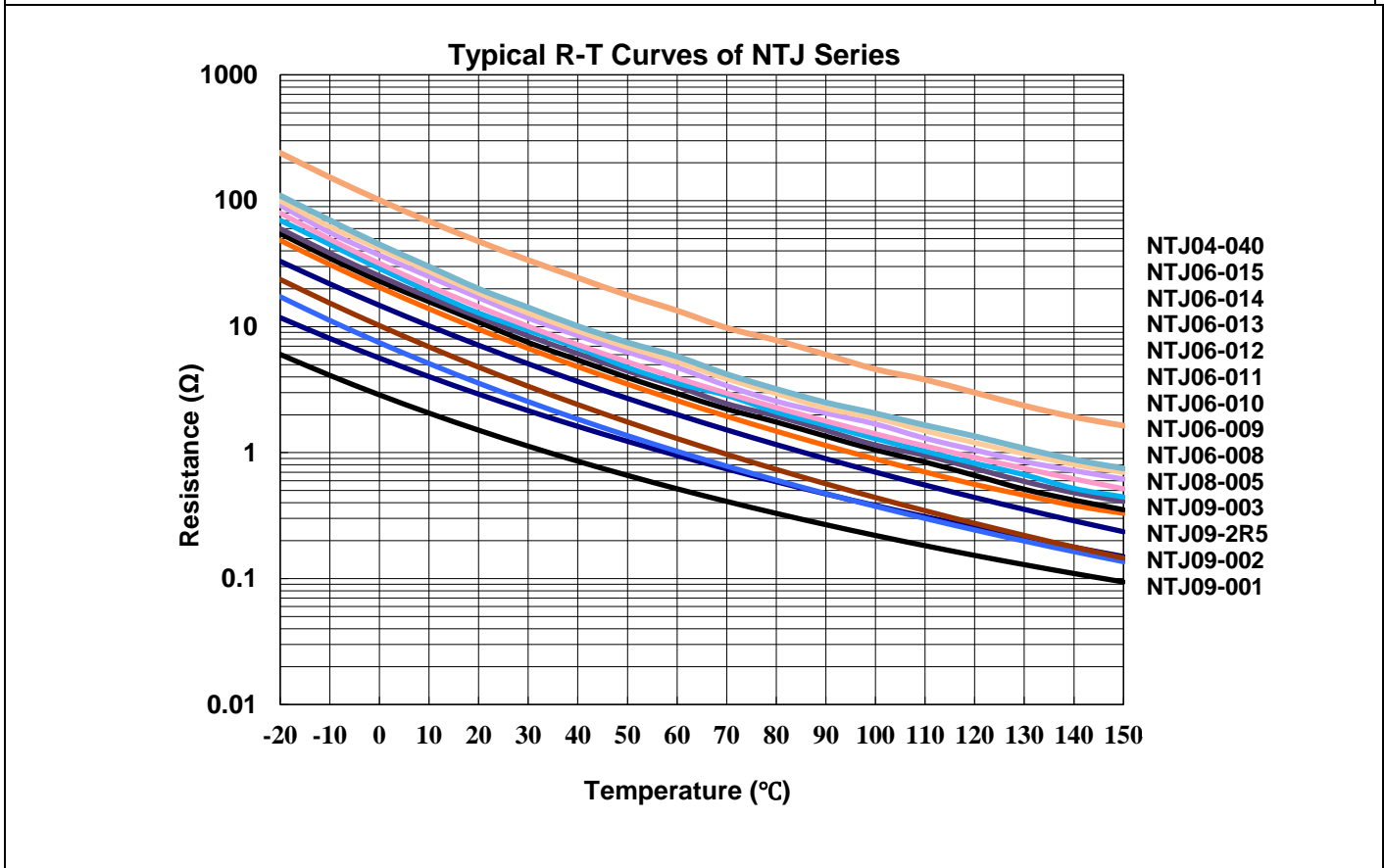
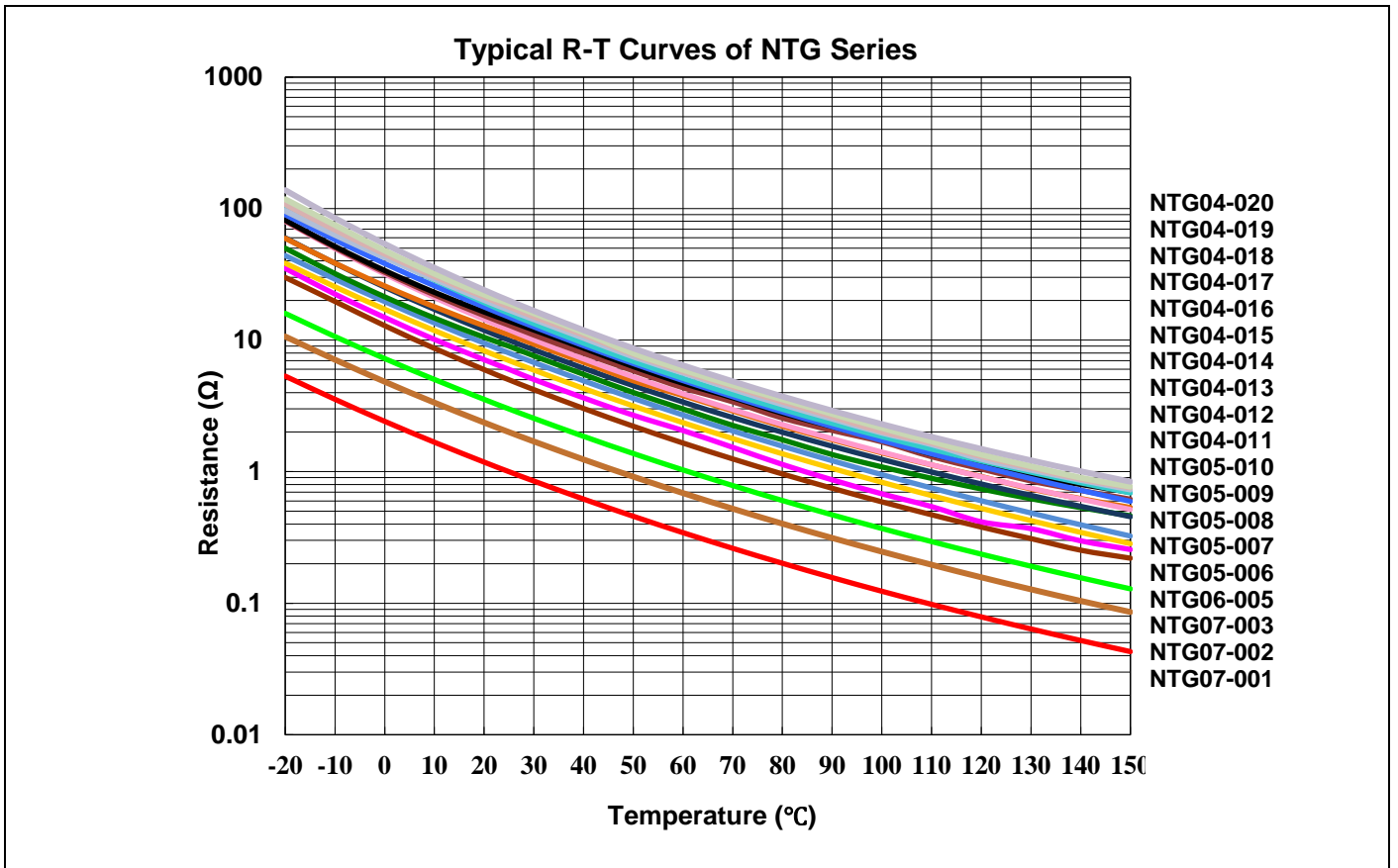

Resistance–Temperature Characteristic Curves

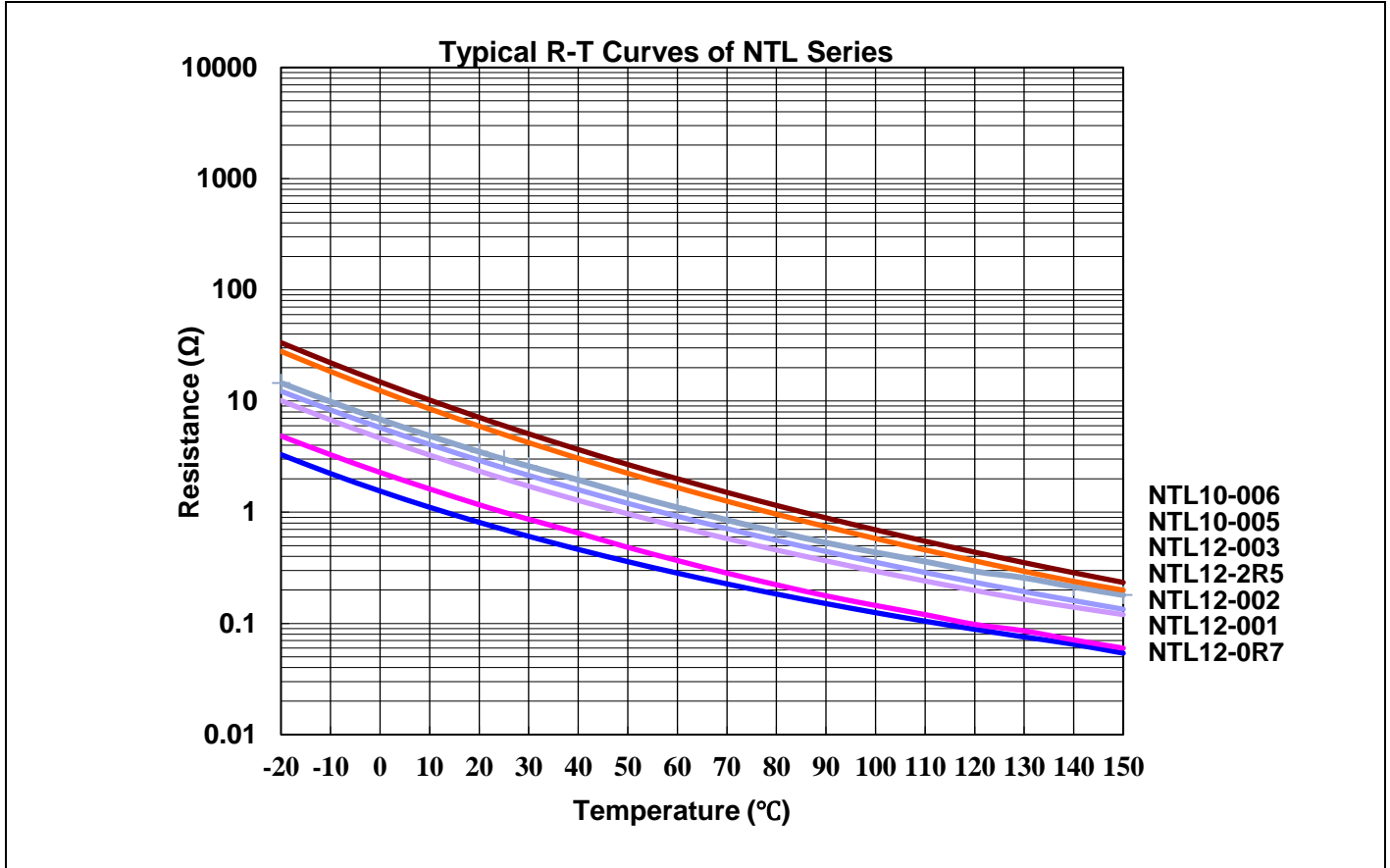

V-I Characteristic Curves

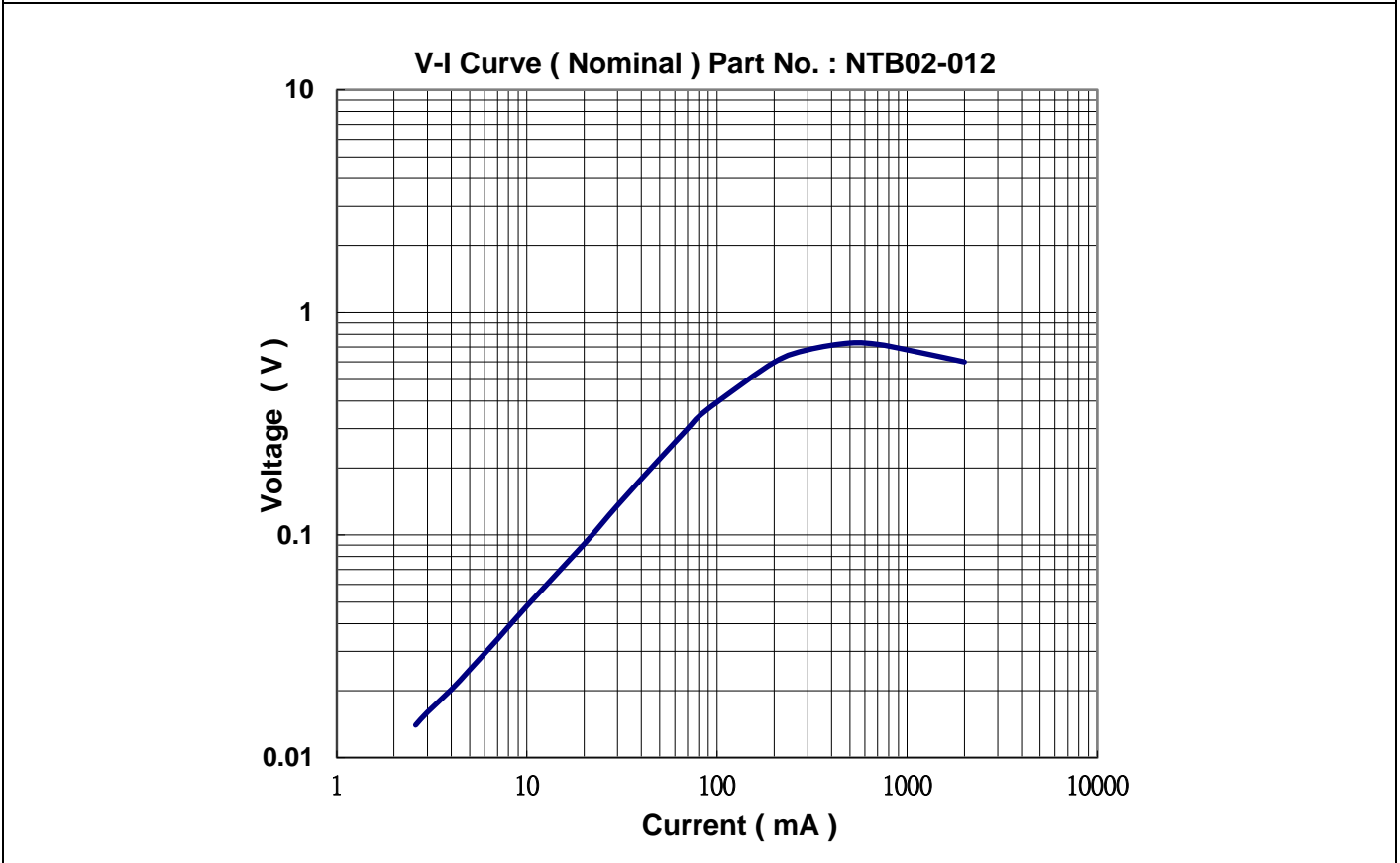
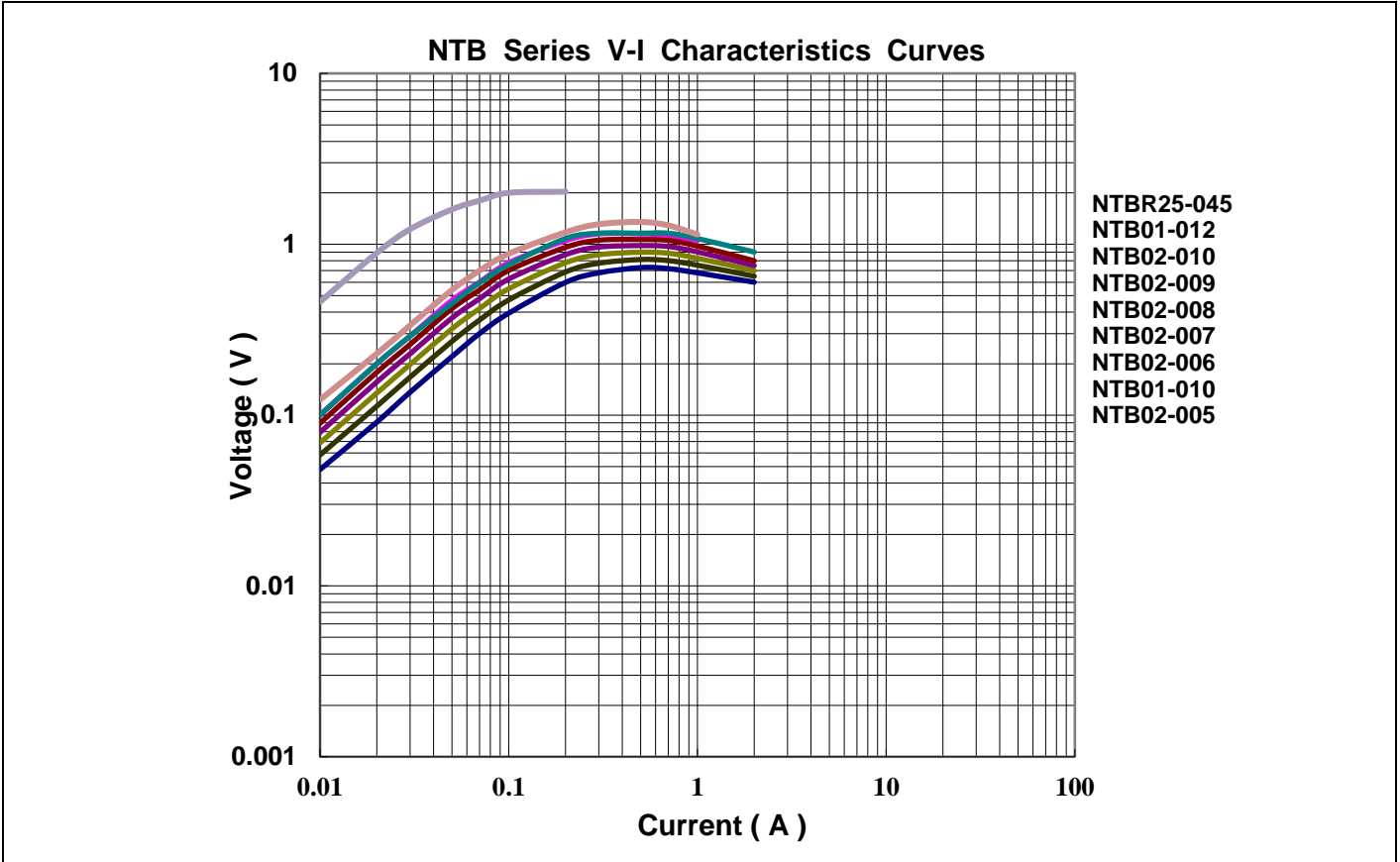

V-I Characteristic Curves

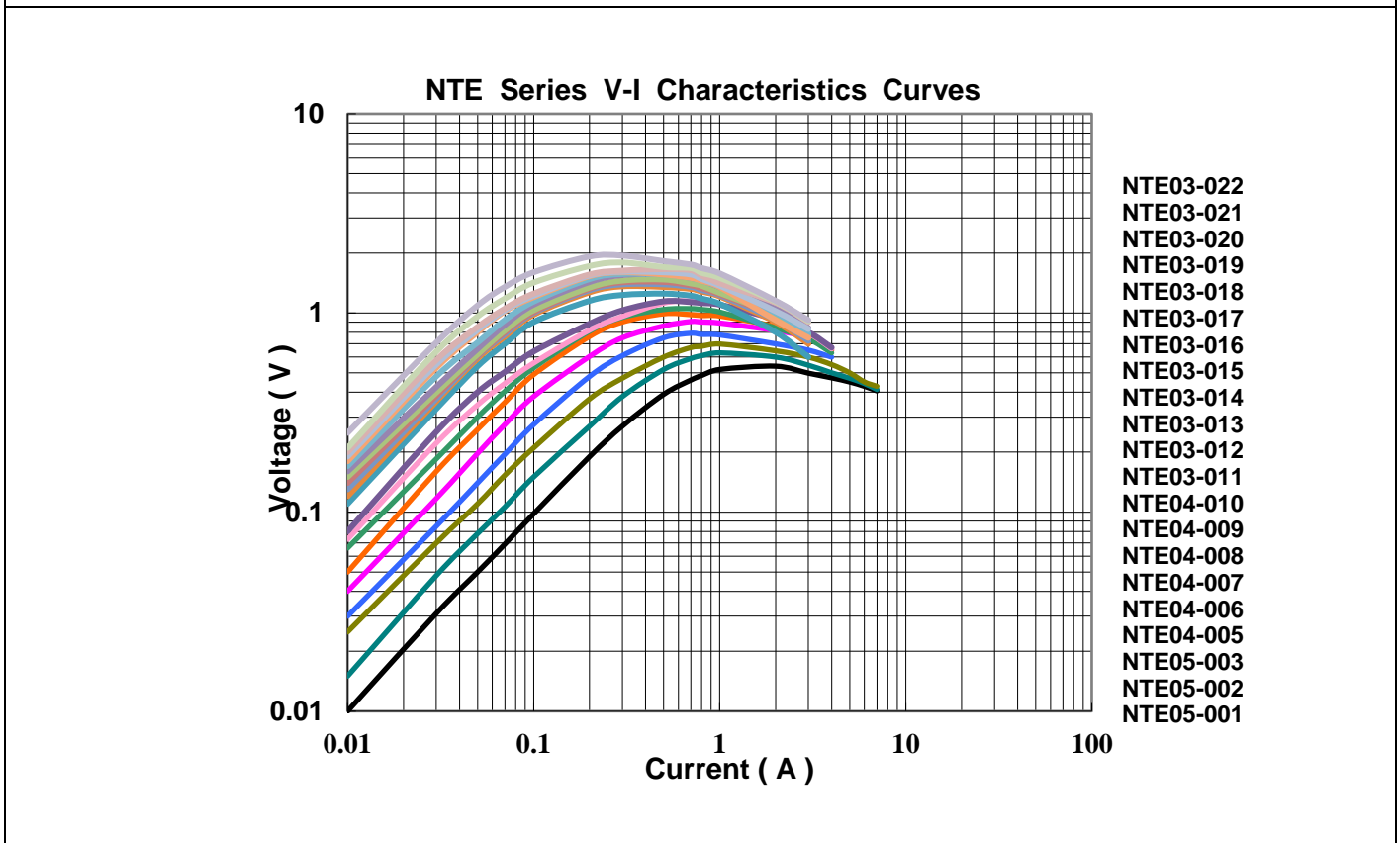
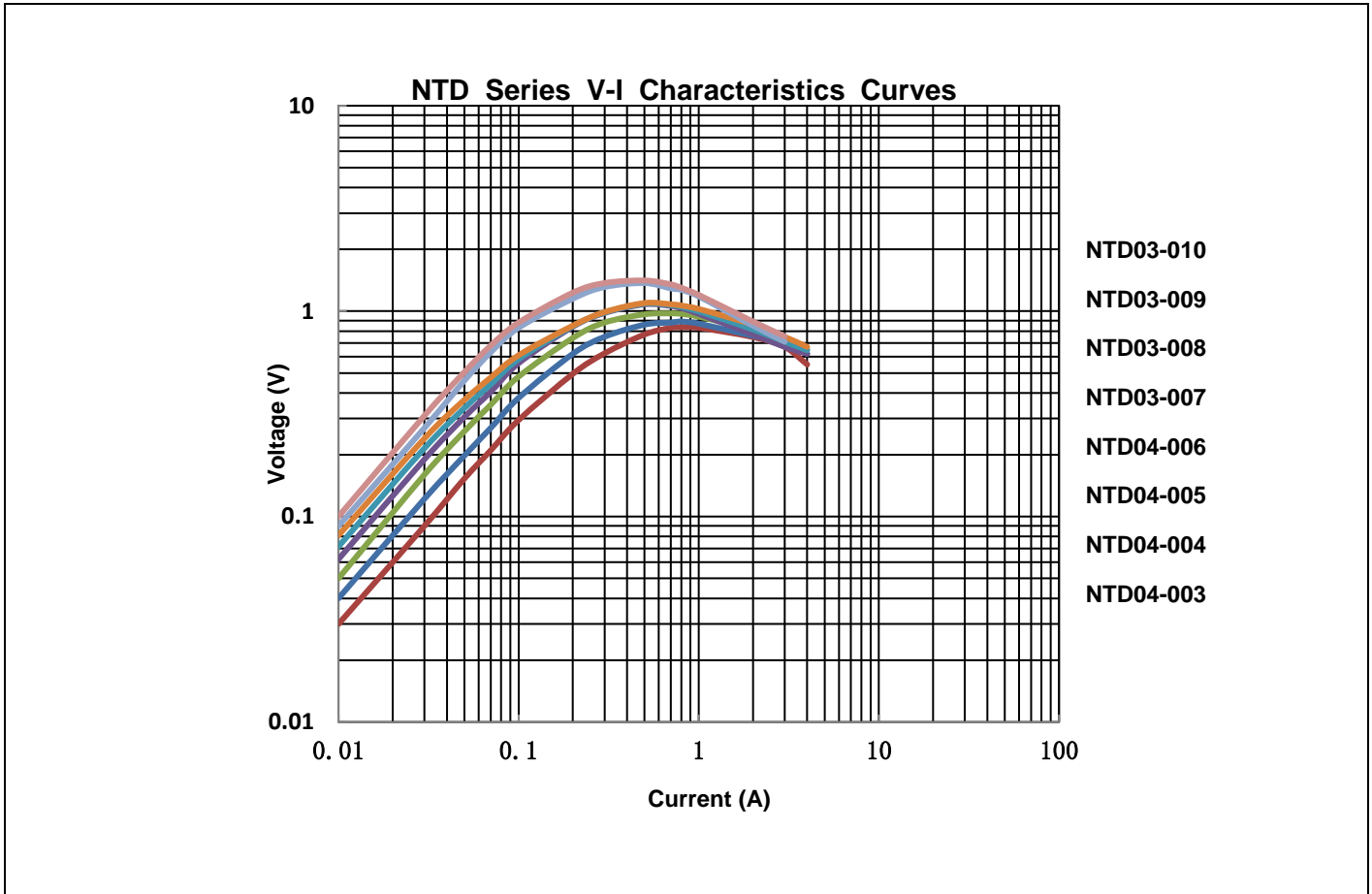

V-I Characteristic Curves

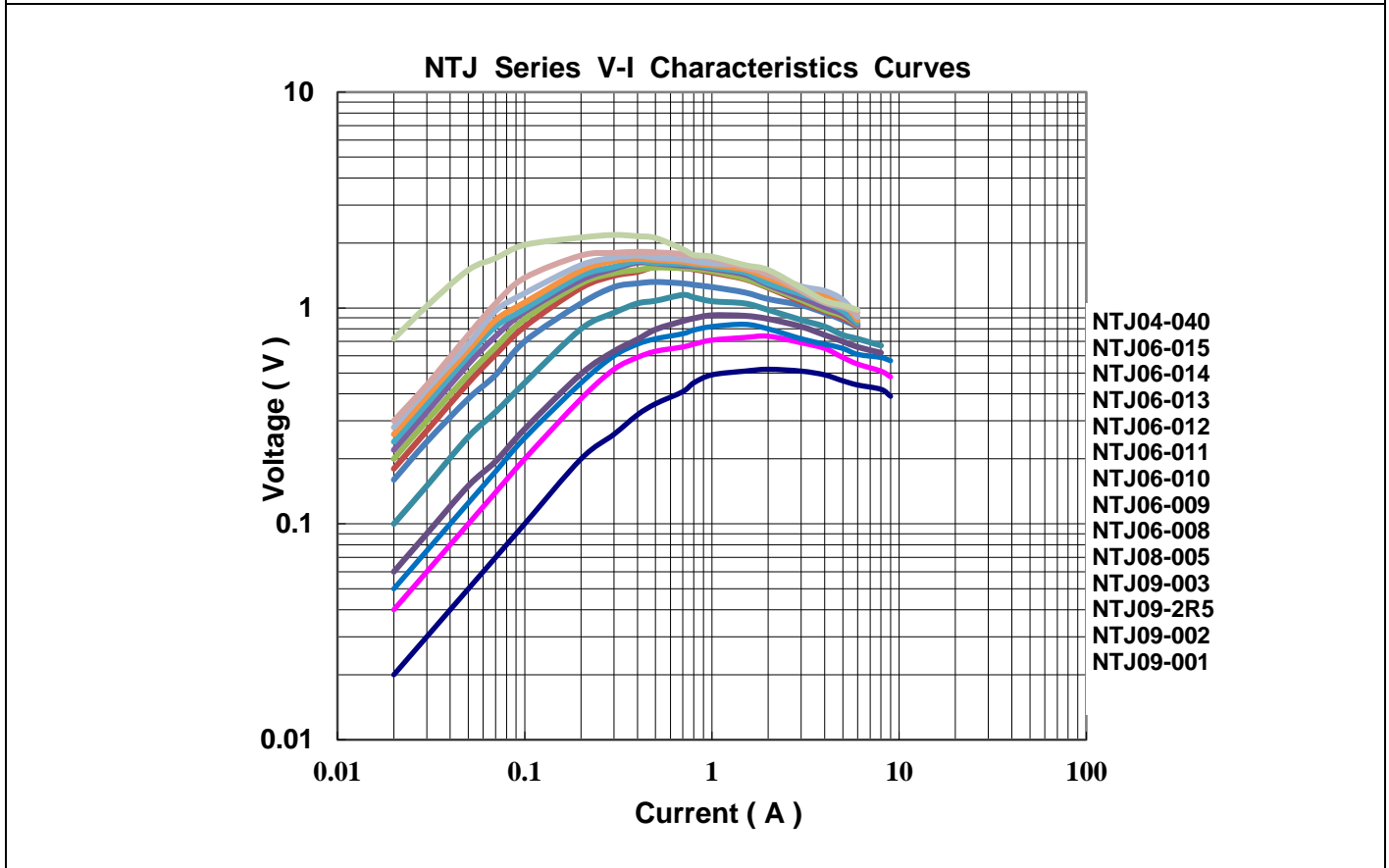
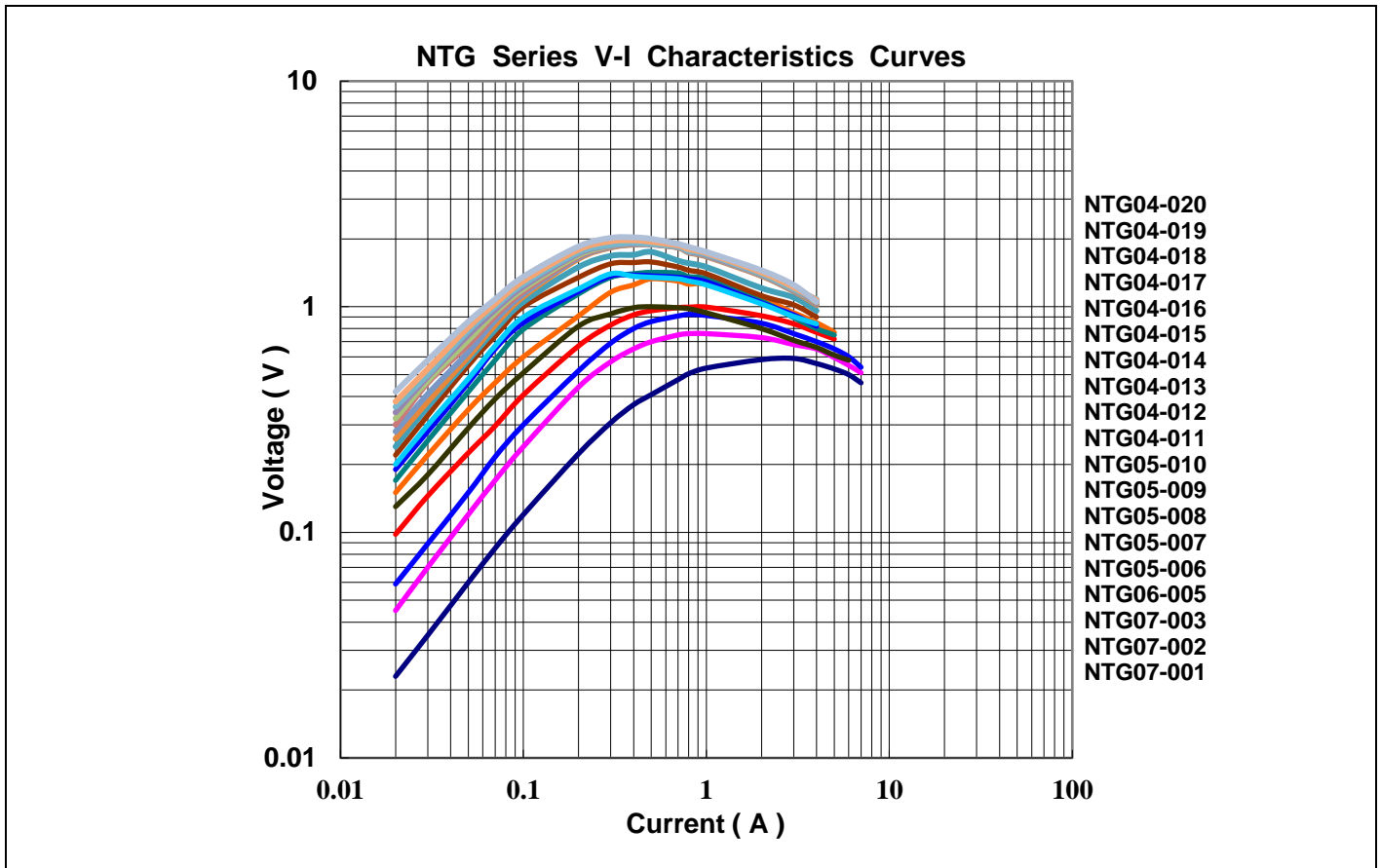

V-I Characteristic Curves

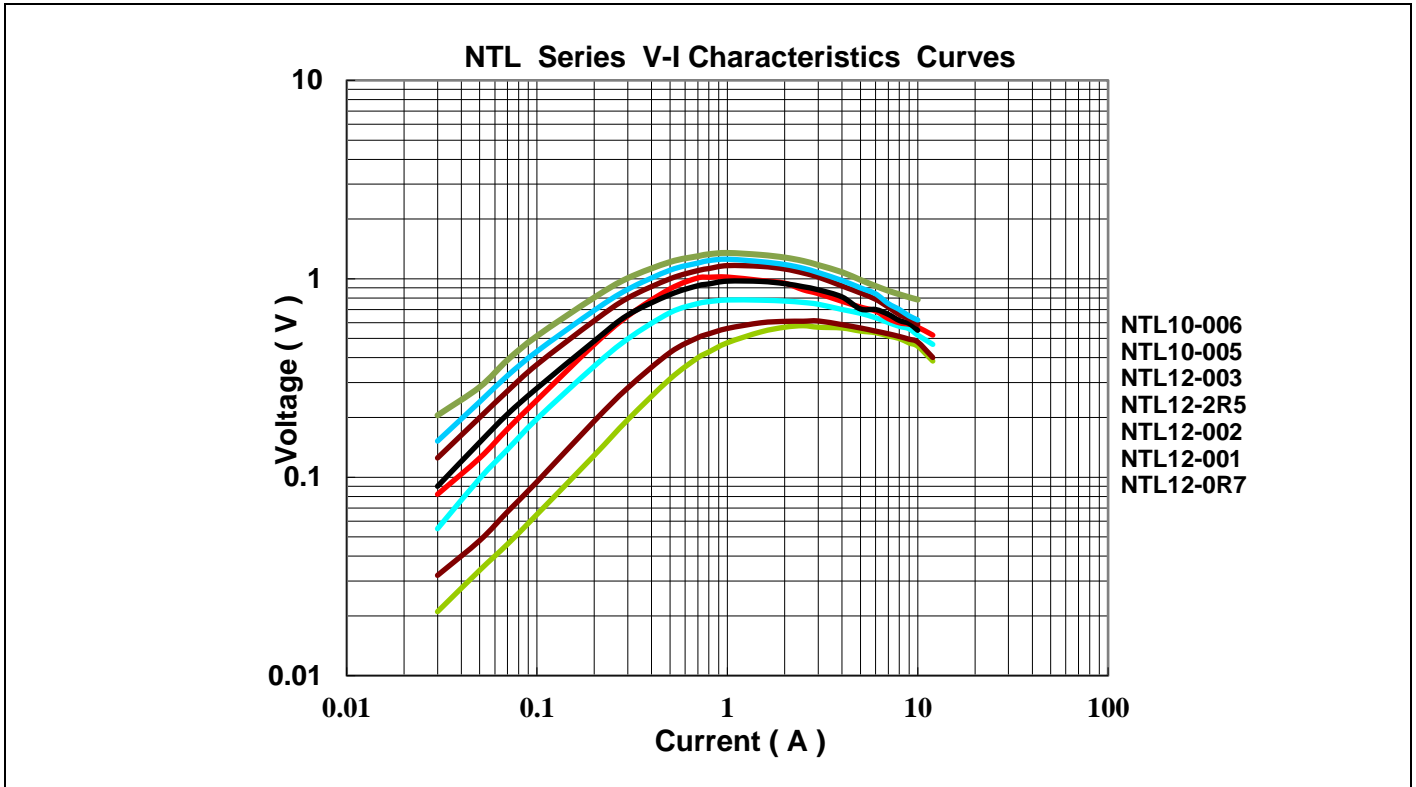

Soldering Recommendation

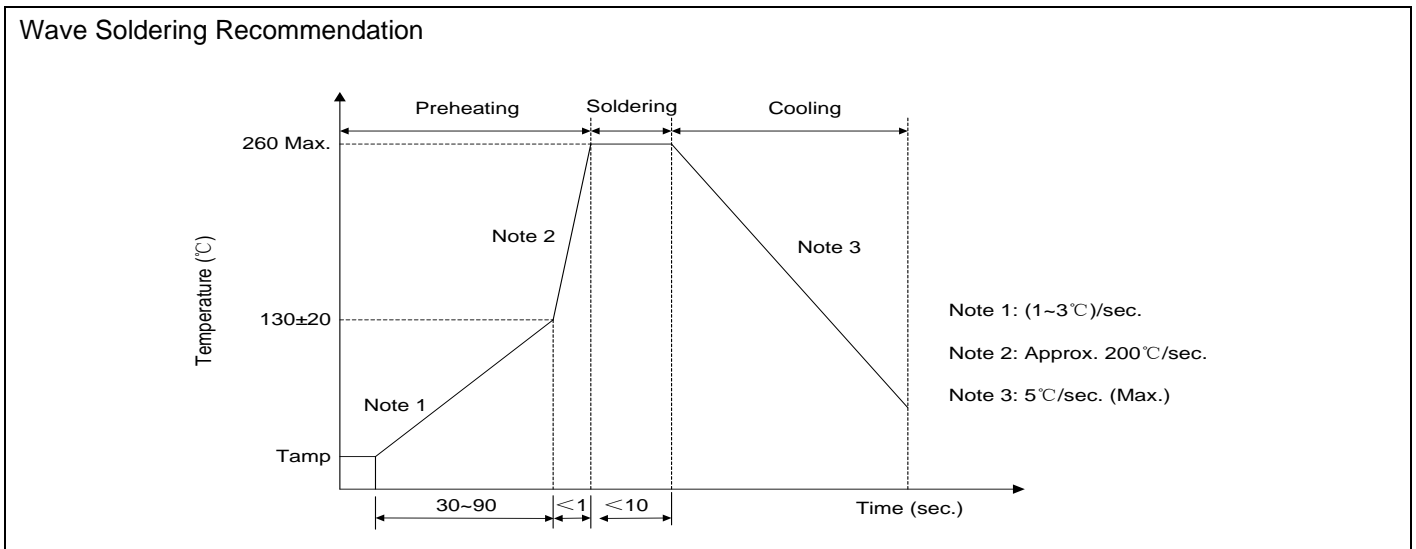

Recommendation Reworking Conditions with Soldering Iron

Item	Conditions
Temperature of Soldering Iron-tip	360°C (max.)
Soldering Time	3 seconds(max.)
Distance from Thermistor	2mm (min.)

Packaging

■ Taping

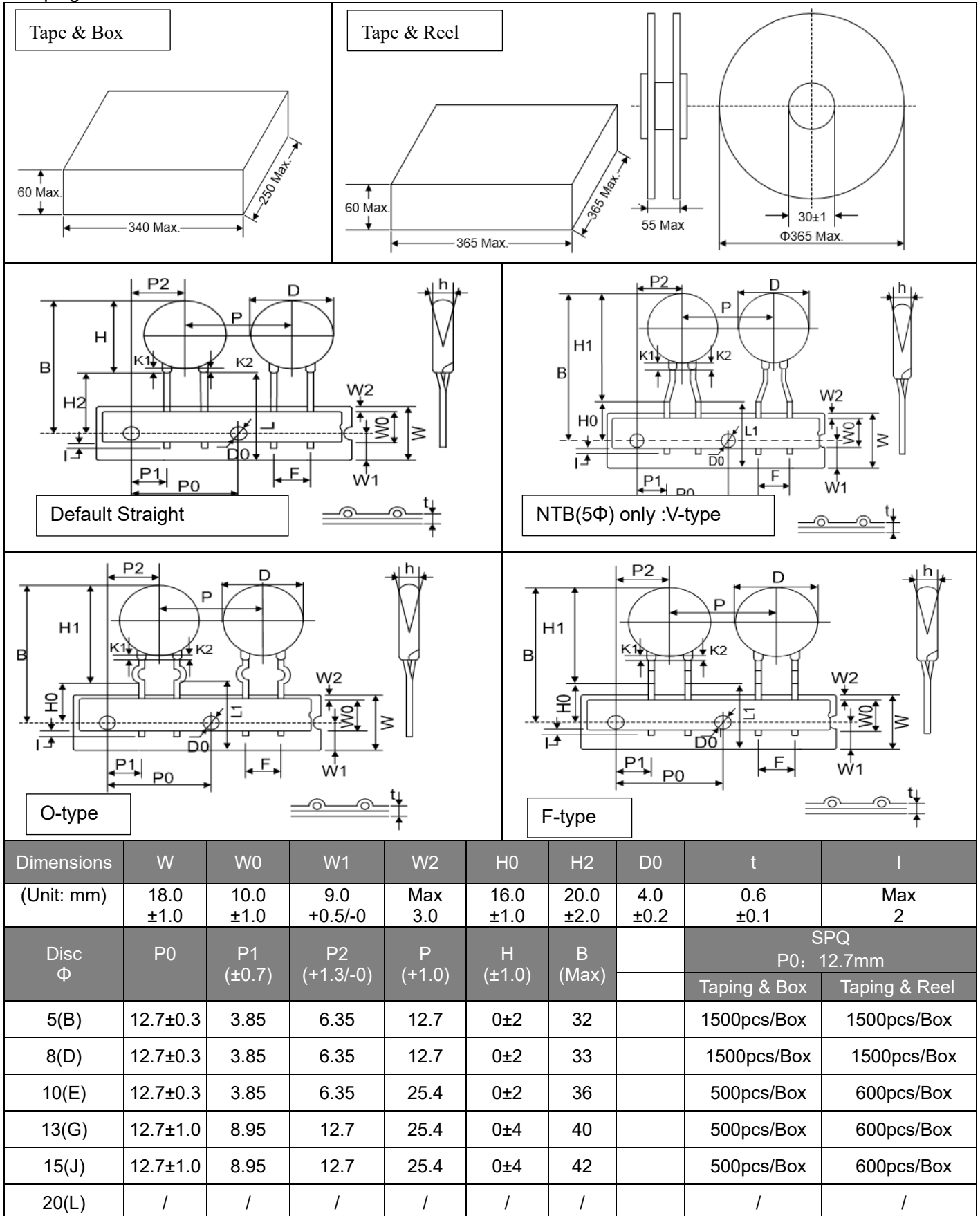

■ Bulk Packing

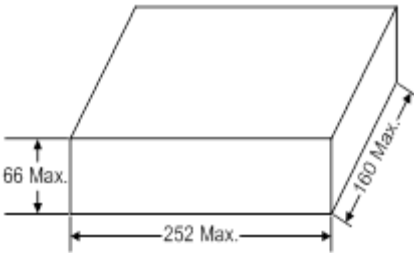
Bulk (Unit: mm)	Disc Φ	SPQ (pcs / Bag)	Quantity	
			(Bags / Box)	(pcs / Box)
	Φ5 (NTB)	700	2	1400
	Φ8 (NTD)	500	2	1000
	Φ10 (NTE)	500	2	1000
	Φ13 (NTG)	300	2	600
	Φ15 (NTJ)	125	4	500
	Φ20 (NTL)	75	4	300

Warehouse Storage Conditions

- Storage temperature: -10°C~+40°C.
- Relative humidity: ≤80%RH.
- Keep away from corrosive atmosphere and sunlight.
- Period of Storage: 1 year.