

F1-2PACK SiC MOSFET Module

Advance Information

NXH010P120MNF1PTNG, NXH010P120MNF1PNG, NXH010P120MNF1PTG, NXH010P120MNF1PG

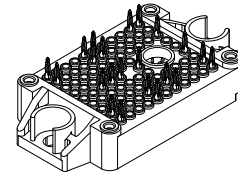

PIM18 33.8x42.5 (PRESS FIT)
CASE 180BW

General Description

The NXH010P120MNF1 is a power module containing an 10 mΩ/1200 V SiC MOSFET half bridge and a thermistor in an F1 package.

Features

- 10 mΩ/1200V SiC MOSFET Half Bridge
- Thermistor
- Options With Pre-Applied Thermal Interface Material (TIM) and Without Pre-Applied TIM
- Press-Fit Pins

Typical Applications

- Solar Inverter
- Uninterruptible Power Supplies
- Electric Vehicle Charging Stations
- Industrial Power

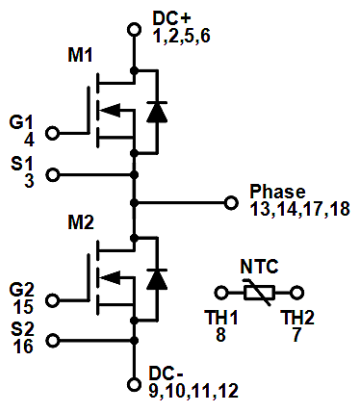
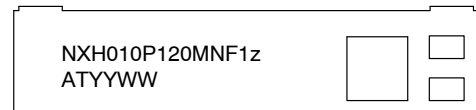

Figure 1. NXH010P120MNF1 Schematic Diagram

This document contains information on a new product. Specifications and information herein are subject to change without notice.

MARKING DIAGRAM



NXH010P120MNF1z = Specific Device Code
z = PTNG/PNG/PTG/PG
AT = Assembly & Test Site Code
YYWW = Year and Work Week Code

ORDERING INFORMATION

See detailed ordering and shipping information on page of this data sheet.

**NXH010P120MNF1PTNG, NXH010P120MNF1PNG, NXH010P120MNF1PTG,
NXH010P120MNF1PG**

PIN CONNECTIONS

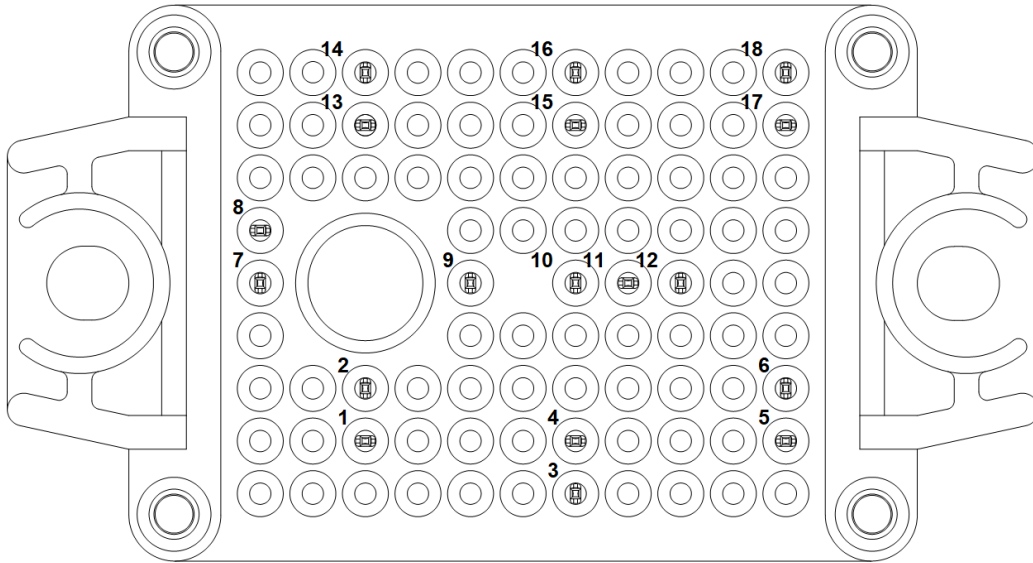

Figure 2. Pin Connections

PIN FUNCTION DESCRIPTION

Pin	Name	Description
8	TH1	Thermistor Connection 1
7	TH2	Thermistor Connection 2
1	DC+	DC Positive Bus connection
2	DC+	DC Positive Bus connection
13	PHASE	Center point of half bridge
14	PHASE	Center point of half bridge
9	DC-	DC Negative Bus connection
3	S1	Q1 Kelvin Emitter (High side switch)
4	G1	Q1 Gate (High side switch)
10	DC-	DC Negative Bus connection
15	G2	Q2 Gate (Low side switch)
16	S2	Q2 Kelvin Emitter (High side switch)
11	DC-	DC Negative Bus connection
12	DC-	DC Negative Bus connection
5	DC+	DC Positive Bus connection
6	DC+	DC Positive Bus connection
17	PHASE	Center point of half bridge
18	PHASE	Center point of half bridge

NXH010P120MNF1PTNG, NXH010P120MNF1PNG, NXH010P120MNF1PTG, NXH010P120MNF1PG

Table 1. ABSOLUTE MAXIMUM RATINGS (Note 1)

Rating	Symbol	Value	Unit
SIC MOSFET			
Drain–Source Voltage	V_{DSS}	1200	V
Gate–Source Voltage	V_{GS}	+25/–15	V
Continuous Drain Current @ $T_c = 80^\circ\text{C}$ ($T_J = 175^\circ\text{C}$)	I_D	114	A
Pulsed Drain Current ($T_J = 175^\circ\text{C}$)	I_{Dpulse}	342	A
Maximum Power Dissipation ($T_J = 175^\circ\text{C}$)	P_{tot}	250	W
Short Circuit Withstand Time @ $V_{GE} = -5\text{V}/20\text{ V}$, $V_{CE} = 600\text{ V}$, $T_J \leq 150^\circ\text{C}$	T_{sc}	2	μs
Minimum Operating Junction Temperature	T_{JMIN}	–40	$^\circ\text{C}$
Maximum Operating Junction Temperature	T_{JMAX}	175	$^\circ\text{C}$

THERMAL PROPERTIES

Storage Temperature range	T_{stg}	–40 to 150	$^\circ\text{C}$
---------------------------	-----------	------------	------------------

INSULATION PROPERTIES

Isolation test voltage, $t = 1\text{ sec}$, 60 Hz	V_{is}	4800	V_{RMS}
Creepage distance		12.7	mm

Stresses exceeding those listed in the Maximum Ratings table may damage the device. If any of these limits are exceeded, device functionality should not be assumed, damage may occur and reliability may be affected.

1. Refer to ELECTRICAL CHARACTERISTICS, RECOMMENDED OPERATING RANGES and/or APPLICATION INFORMATION for Safe Operating parameters.

RECOMMENDED OPERATING RANGES

Rating	Symbol	Min	Max	Unit
Module Operating Junction Temperature	T_J	–40	150	$^\circ\text{C}$

Functional operation above the stresses listed in the Recommended Operating Ranges is not implied. Extended exposure to stresses beyond the Recommended Operating Ranges limits may affect device reliability.

ELECTRICAL CHARACTERISTICS

$T_J = 25^\circ\text{C}$ unless otherwise noted

Parameter	Test Conditions	Symbol	Min	Typ	Max	Unit
SIC MOSFET CHARACTERISTICS						
Drain–Source Breakdown Voltage	$V_{GS} = 0\text{ V}$, $I_D = 400\ \mu\text{A}$	$V_{(BR)DSS}$	1200	–	–	V
Zero Gate Voltage Drain Current	$V_{GS} = 0\text{ V}$, $V_{DS} = 1200\text{ V}$	I_{DSS}	–	–	200	μA
Drain–Source On Resistance	$V_{GS} = 20\text{ V}$, $I_D = 100\text{ A}$, $T_J = 25^\circ\text{C}$	$R_{DS(ON)}$	–	10.5	14	m Ω
	$V_{GS} = 20\text{ V}$, $I_D = 100\text{ A}$, $T_J = 125^\circ\text{C}$		–	14.1	–	
	$V_{GS} = 20\text{ V}$, $I_D = 100\text{ A}$, $T_J = 150^\circ\text{C}$		–	14.5	–	
Gate–Source Threshold Voltage	$V_{GS} = V_{DS}$, $I_D = 40\text{ mA}$	$V_{GS(TH)}$	1.8	2.90	4.3	V
Gate Leakage Current	$V_{GS} = -10/20\text{ V}$, $V_{DS} = 0\text{ V}$	I_{GSS}	–500	–	500	nA
Internal Gate Resistance		R_G		0.8		Ω
Input Capacitance	$V_{DS} = 800\text{ V}$, $V_{GS} = 0\text{ V}$. $f = 1\text{ MHz}$	C_{ISS}	–	4707	–	pF
Reverse Transfer Capacitance		C_{RSS}	–	39	–	
Output Capacitance		C_{OSS}	–	548	–	
C_{OSS} Stored Energy	$V_{DS} = 0\text{ V}$ to 800 V, $V_{GS} = 0\text{ V}$	E_{OSS}	–	221	–	μJ
Total Gate Charge	$V_{DS} = 800\text{ V}$, $V_{GS} = 20\text{ V}$. $I_D = 100\text{ A}$	$Q_{G(TOTAL)}$	–	454	–	nC
Gate–Source Charge		Q_{GS}	–	129	–	nC
Gate–Drain Charge		Q_{GD}	–	131	–	nC

NXH010P120MNF1PTNG, NXH010P120MNF1PNG, NXH010P120MNF1PTG, NXH010P120MNF1PG

ELECTRICAL CHARACTERISTICS (continued)

T_J = 25°C unless otherwise noted

Parameter	Test Conditions	Symbol	Min	Typ	Max	Unit
SiC MOSFET CHARACTERISTICS						
Turn-on Delay Time	T _J = 25°C V _{DS} = 600 V, I _D = 100 A V _{GS} = -5V/18V, R _G = 2 Ω	t _{d(on)}	-	44.2	-	ns
Rise Time		t _r	-	16.2	-	
Turn-off Delay Time		t _{d(off)}	-	136.6	-	
Fall Time		t _f	-	9.8	-	
Turn-on Switching Loss per Pulse		E _{ON}	-	0.95	-	mJ
Turn off Switching Loss per Pulse		E _{OFF}	-	0.72	-	
Turn-on Delay Time	T _J = 150°C V _{DS} = 600 V, I _D = 100 A V _{GS} = -5V/18V, R _G = 2 Ω	t _{d(on)}	-	40.2	-	ns
Rise Time		t _r	-	14.9	-	
Turn-off Delay Time		t _{d(off)}	-	150.3	-	
Fall Time		t _f	-	12.7	-	
Turn-on Switching Loss per Pulse		E _{ON}	-	1.1	-	mJ
Turn off Switching Loss per Pulse		E _{OFF}	-	0.81	-	
Diode Forward Voltage	I _D = 100 A, T _J = 25°C	V _{SD}	-	3.94	6	V
	I _D = 100 A, T _J = 150°C		-	3.42	-	
Reverse Recovery Time	T _J = 25°C V _{DS} = 600 V, I _D = 100 A V _{GS} = -5V/18V, R _G = 2 Ω	t _{rr}	-	24.2	-	ns
Reverse Recovery Charge		Q _{rr}	-	1207	-	nC
Peak Reverse Recovery Current		I _{RRM}	-	79.8	-	A
Peak Rate of Fall of Recovery Current		di/dt	-	7570	-	A/μs
Reverse Recovery Energy		E _{rr}	-	516	-	μJ
Reverse Recovery Time		T _J = 150°C V _{DS} = 600 V, I _D = 100 A V _{GS} = -5V/18V, R _G = 2 Ω	t _{rr}	-	31.2	-
Reverse Recovery Charge	Q _{rr}		-	2591	-	μC
Peak Reverse Recovery Current	I _{RRM}		-	134.2	-	A
Peak Rate of Fall of Recovery Current	di/dt		-	11849	-	A/μs
Reverse Recovery Energy	E _{rr}		-	1198	-	μJ
Thermal Resistance – chip-to-case	M1,M2		R _{thJC}	-	0.23	-
Thermal Resistance – chip-to-heatsink	Thermal Resistance – chip-to-heatsink, Thermal grease, Thickness = 2 Mil _2%, A = 2.8 W/mK	R _{thJH}	-	0.38	-	°C/W

Thermistor Characteristics

Nominal resistance	T = 25°C	R ₂₅	-	5	-	kΩ
Nominal resistance	T = 100°C	R ₁₀₀	-	457	-	Ω
Deviation of R25		ΔR/R	-3	-	3	%
Power dissipation		P _D	-	50	-	mW
Power dissipation constant			-	5	-	mW/K
B-value	B(25/50), tolerance ±3%		-	3375	-	K
B-value	B(25/100), tolerance ±3%		-	3455	-	K

**NXH010P120MNF1PTNG, NXH010P120MNF1PNG, NXH010P120MNF1PTG,
NXH010P120MNF1PG**

ORDERING INFORMATION

Orderable Part Number	Specific Device Marking	Package Type	Shipping†
NXH010P120MNF1PNG	NXH010P120MNF1PNG	F1-2PACK: Case 180BW Press-fit Pins, Ni-Plated DBC (Pb-Free and Halide-Free)	28 Units / Blister Tray
NXH010P120MNF1PTNG	NXH010P120MNF1PTNG	F1-2PACK: Case 180BW Press-fit Pins, Ni-Plated DBC with pre-applied thermal interface material (TIM) (Pb-Free and Halide-Free)	28 Units / Blister Tray
NXH010P120MNF1PG	NXH010P120MNF1PG	F1-2PACK: Case 180BW Press-fit Pins, Copper DBC (Pb-Free and Halide-Free)	28 Units / Blister Tray
NXH010P120MNF1PTG	NXH010P120MNF1PTG	F1-2PACK: Case 180BW Press-fit Pins, Copper DBC with pre-applied thermal interface material (TIM) (Pb-Free and Halide-Free)	28 Units / Blister Tray

†For information on tape and reel specifications, including part orientation and tape sizes, please refer to our Tape and Reel Packaging Specifications Brochure, BRD8011/D.

NXH010P120MNF1PTNG, NXH010P120MNF1PNG, NXH010P120MNF1PTG, NXH010P120MNF1PG

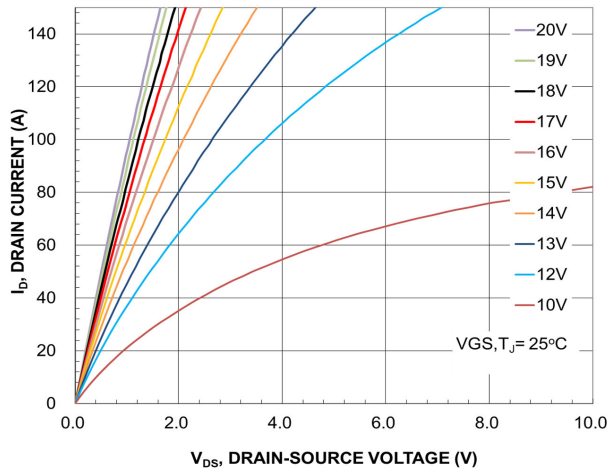

Figure 3. MOSFET Typical Output Characteristics

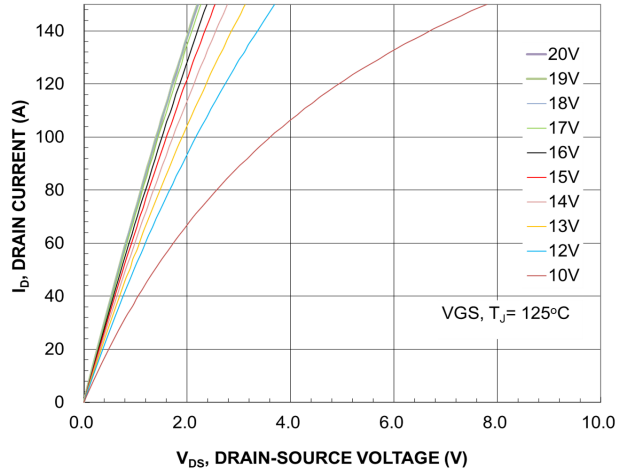

Figure 4. MOSFET Typical Output Characteristics

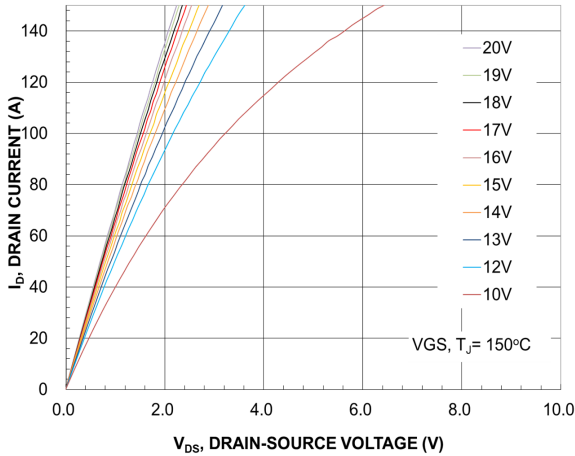

Figure 5. MOSFET Typical Output Characteristics

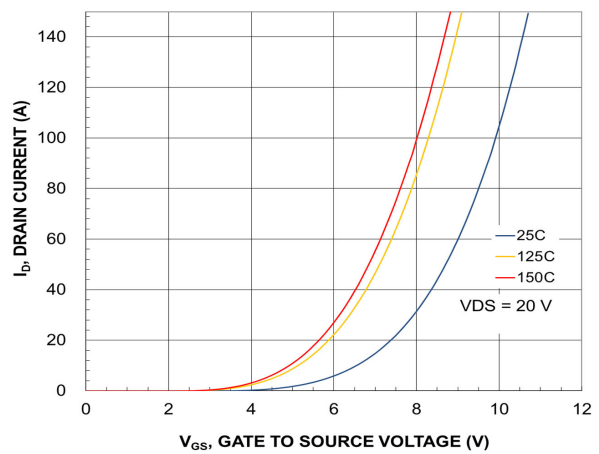

Figure 6. MOSFET Typical Transfer Characteristics

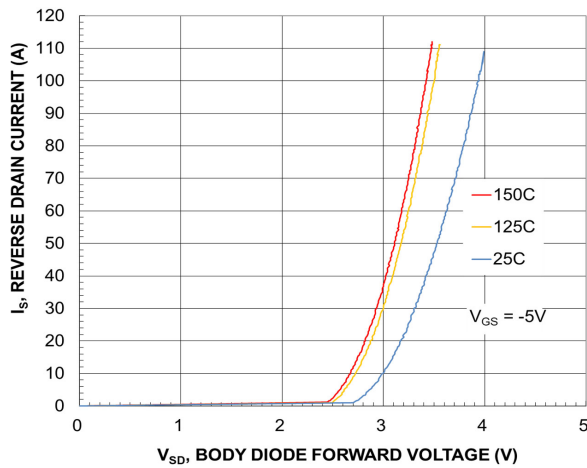

Figure 7. Body Diode Forward Characteristic

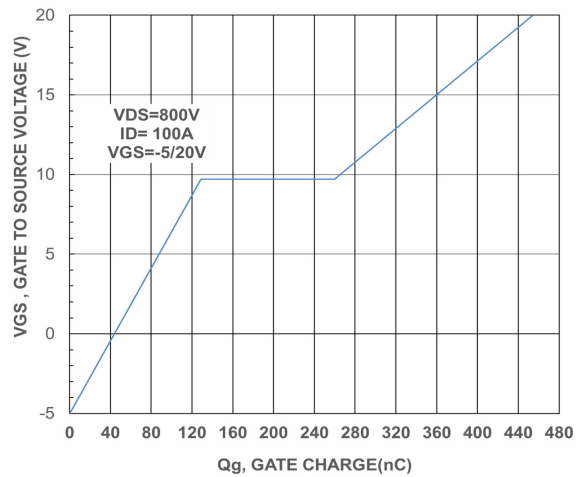

Figure 8. Gate-to-Source Voltage vs. Total Charge

NXH010P120MNF1PTNG, NXH010P120MNF1PNG, NXH010P120MNF1PTG,
NXH010P120MNF1PG

TYPICAL CHARACTERISTICS

SiC MOSFET (M1, M2)

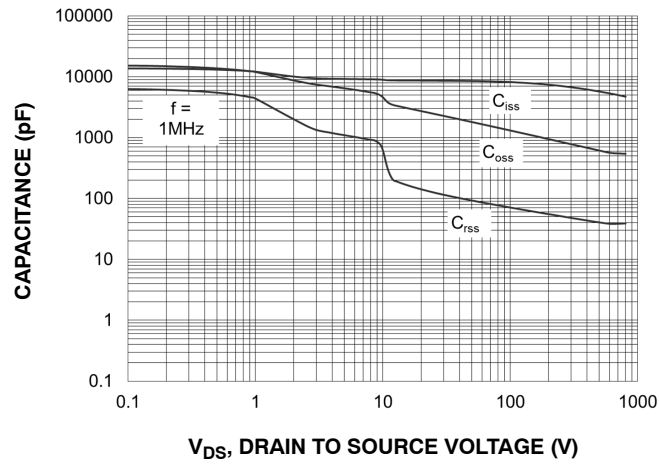

Figure 9. Capacitance vs. Drain-to-Source Voltage

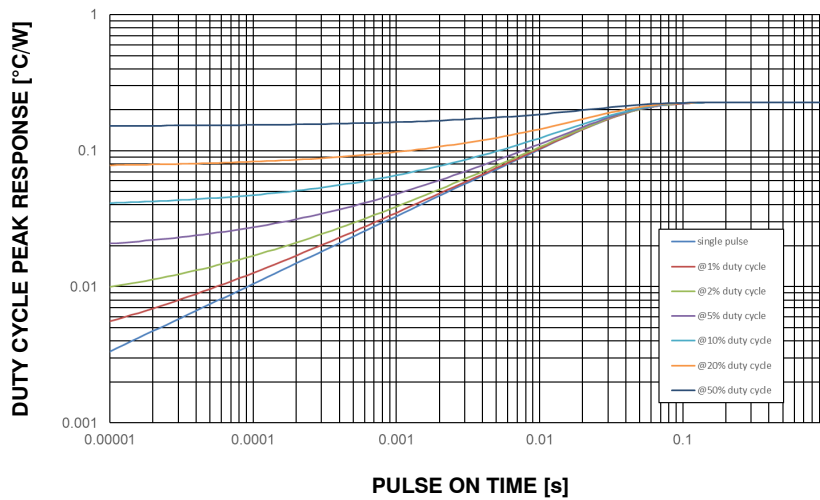

Figure 10. SiC Mosfet Junction-to-Case Transient Thermal Impedance

Element #	M1		M2	
	Rth (K/W)	Cth (Ws/K)	Rth (K/W)	Cth (Ws/K)
1	0.00569	0.00195	0.01290	0.00461
2	0.01079	0.00951	0.02387	0.02538
3	0.03005	0.01813	0.04253	0.02953
4	0.08398	0.08121	0.07199	0.08994
5	0.09325	0.11117	0.07823	0.06854

Figure 11. Table of Cauer Networks-M1, M2

NXH010P120MNF1PTNG, NXH010P120MNF1PNG, NXH010P120MNF1PTG, NXH010P120MNF1PG

TYPICAL CHARACTERISTICS

M1/M2 MOSFET SWITCHING CHARACTERISTICS

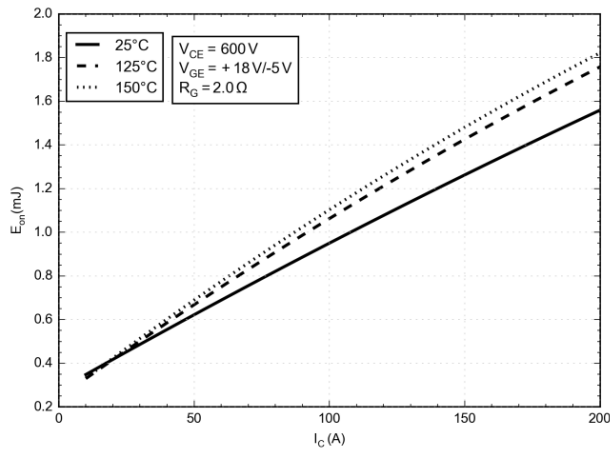

Figure 12. Typical Switching Loss E_{ON} vs. I_C

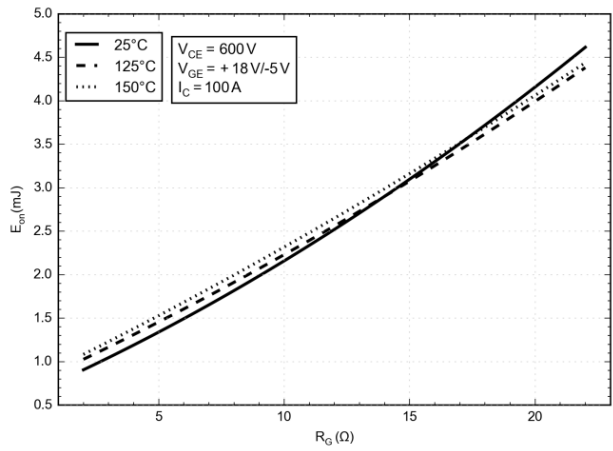

Figure 13. Typical Switching Loss E_{ON} vs. R_G

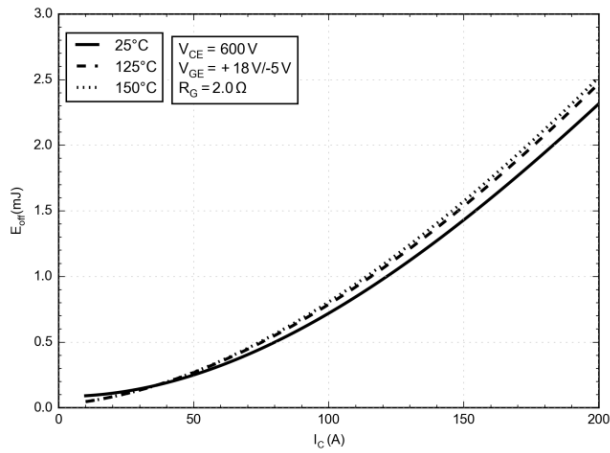

Figure 14. Typical Switching Loss E_{Off} vs. I_C

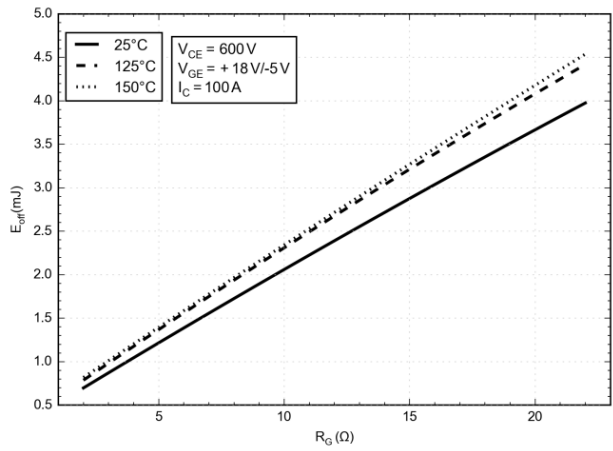

Figure 15. Typical Switching Loss E_{Off} vs. R_G

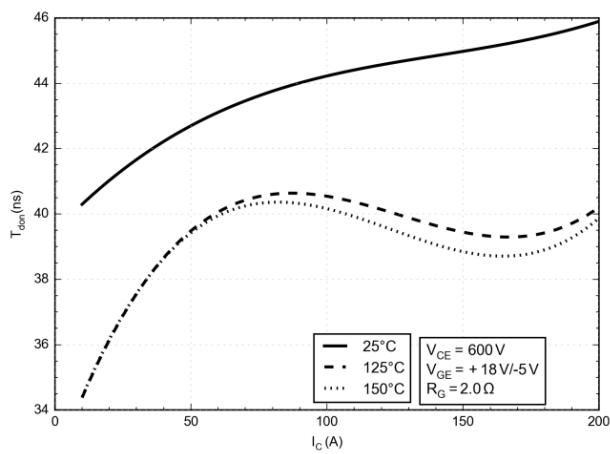

Figure 16. Typical Turn-On Switching T_{don} vs. I_C

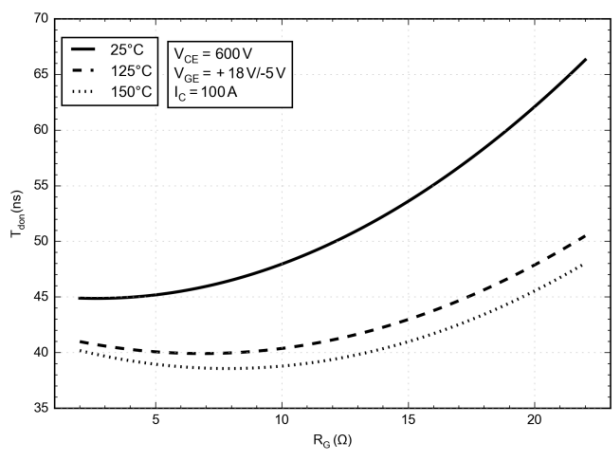

Figure 17. Typical Turn-On Switching T_{don} vs. R_G

NXH010P120MNF1PTNG, NXH010P120MNF1PNG, NXH010P120MNF1PTG, NXH010P120MNF1PG

TYPICAL CHARACTERISTICS

M1/M2 MOSFET SWITCHING CHARACTERISTICS

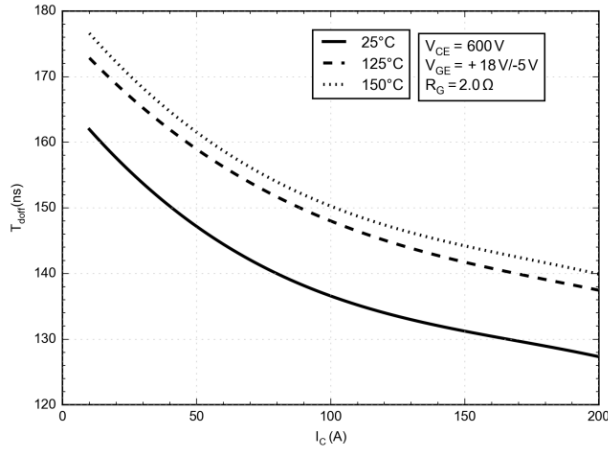

Figure 18. Typical Turn-Off Switching T_{doff} vs. I_C

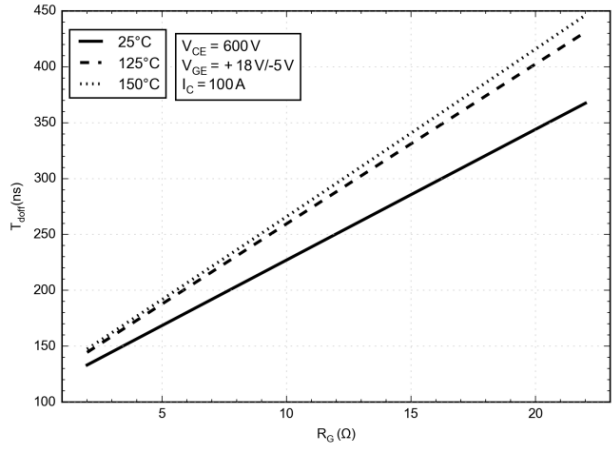

Figure 19. Typical Turn-Off Switching T_{doff} vs. R_G

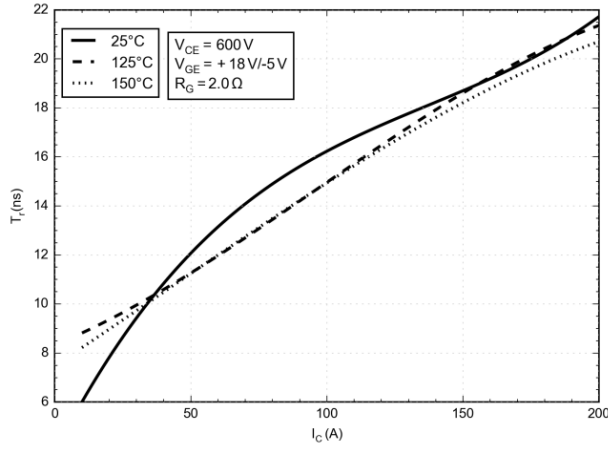

Figure 20. Typical Turn-On Switching T_r vs. I_C

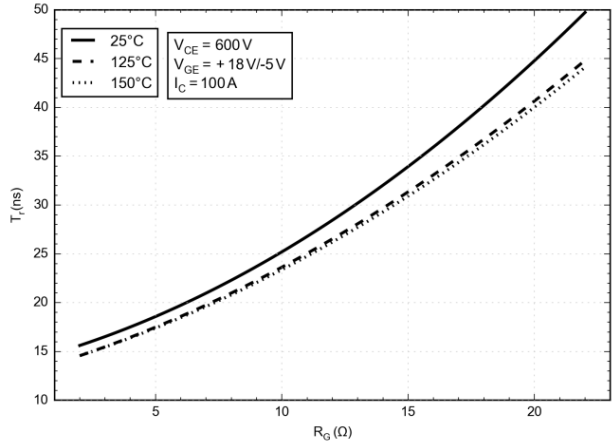

Figure 21. Typical Turn-On Switching T_r vs. R_G

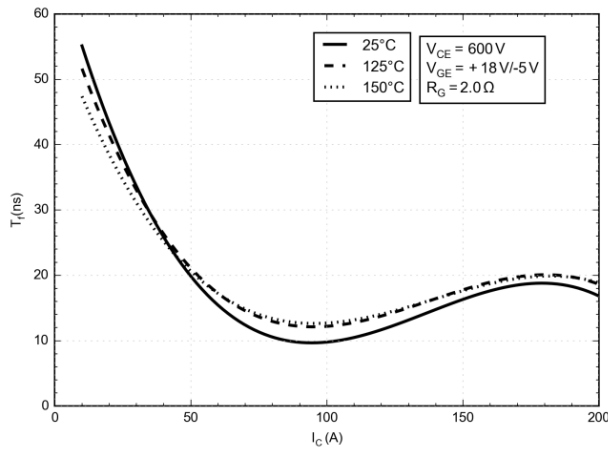

Figure 22. Typical Turn-Off Switching T_f vs. I_C

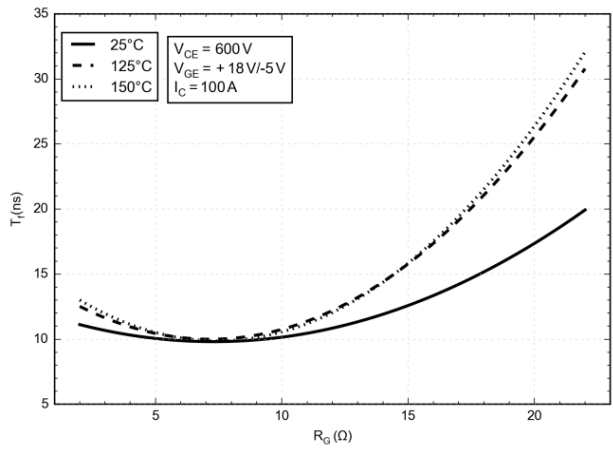

Figure 23. Typical Turn-Off Switching T_f vs. R_G

NXH010P120MNF1PTNG, NXH010P120MNF1PNG, NXH010P120MNF1PTG, NXH010P120MNF1PG

TYPICAL CHARACTERISTICS M1/M2 MOSFET SWITCHING CHARACTERISTICS

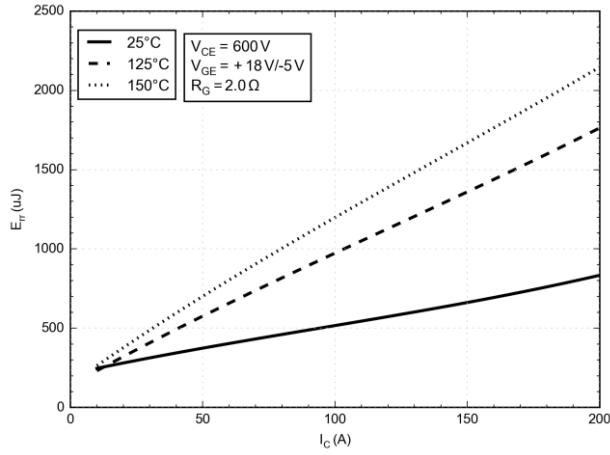

Figure 24. Typical Reverse Recovery Energy vs. IC

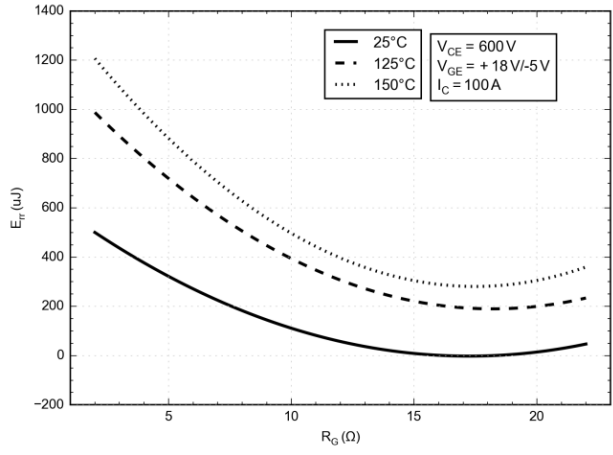

Figure 25. Typical Reverse Recovery Energy vs. R_G

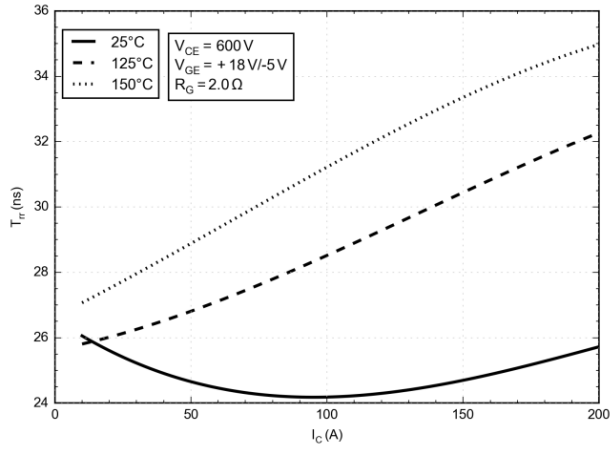

Figure 26. Typical Reverse Recovery Time vs. IC

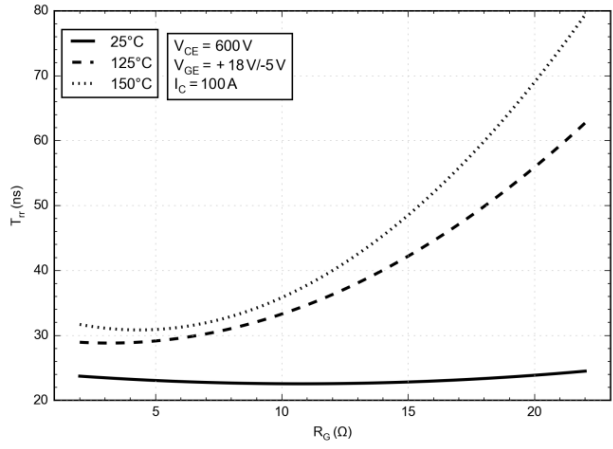

Figure 27. Typical Reverse Recovery Time vs. R_G

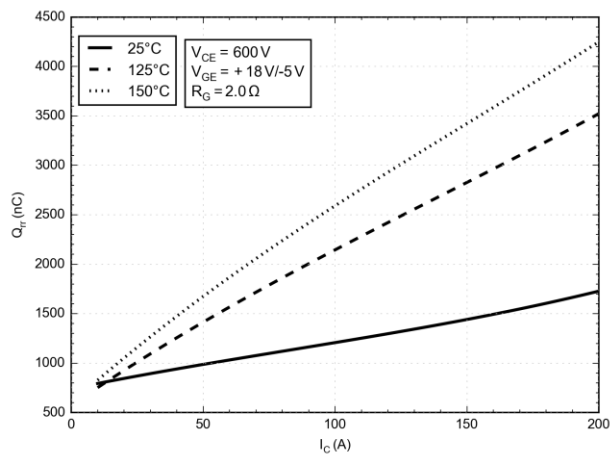

Figure 28. Typical Reverse Recovery Charge vs. IC

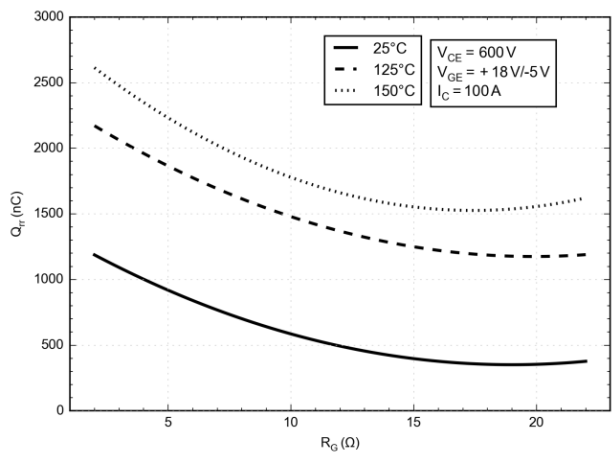

Figure 29. Typical Reverse Recovery Charge vs. R_G

NXH010P120MNF1PTNG, NXH010P120MNF1PNG, NXH010P120MNF1PTG, NXH010P120MNF1PG

TYPICAL CHARACTERISTICS

M1/M2 MOSFET SWITCHING CHARACTERISTICS

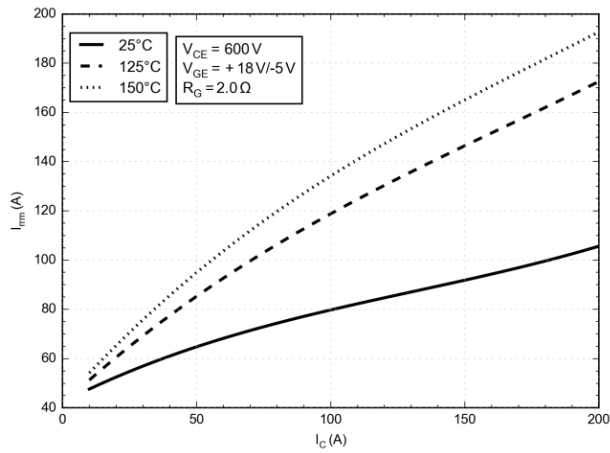

Figure 30. Typical Reverse Recovery Current vs. I_C

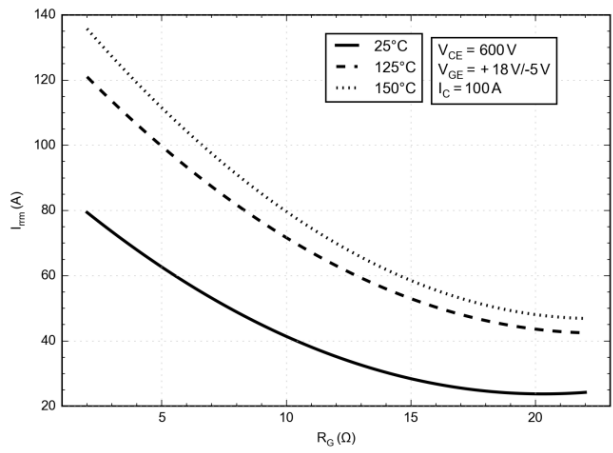

Figure 31. Typical Reverse Recovery Current vs. R_G

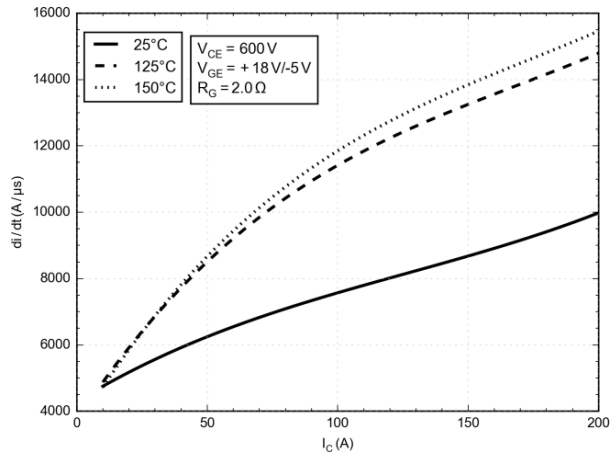

Figure 32. Typical di/dt vs. I_C

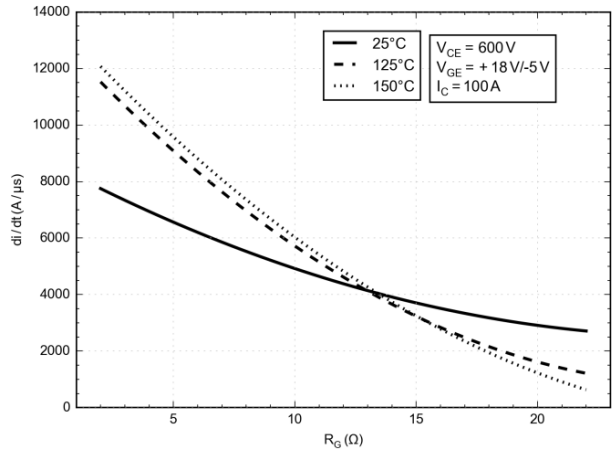

Figure 33. Typical di/dt vs. R_G