

# Dual Boost Power Module

## NXH100B120H3Q0, NXH100B120H3Q0PG-R

The NXH100B120H3Q0 is a power module containing a dual boost stage. The integrated field stop trench IGBTs and SiC Diodes provide lower conduction losses and switching losses, enabling designers to achieve high efficiency and superior reliability.

### Features

- 1200 V Ultra Field Stop IGBTs
- Low Reverse Recovery and Fast Switching SiC Diodes
- 1600 V Bypass and Anti-parallel Diodes
- Low Inductive Layout
- Solderable Pins or Press-Fit Pins
- Thermistor
- Options with Pre-Applied Thermal Interface Material (TIM) and Without Pre-Applied TIM

### Typical Applications

- Solar Inverter
- Uninterruptible Power Supplies
- Energy Storage Systems

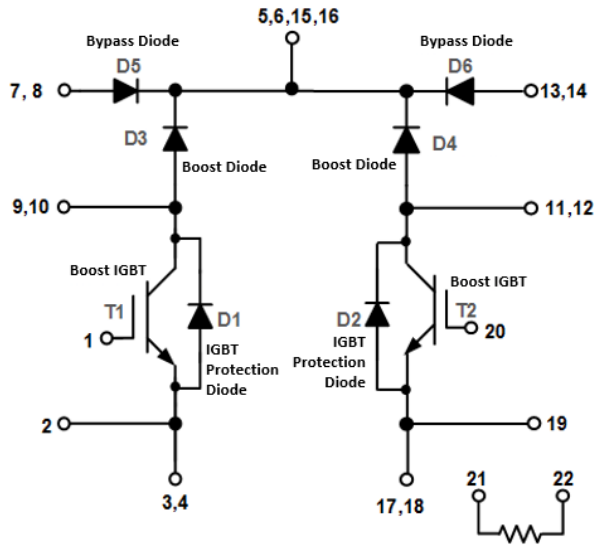
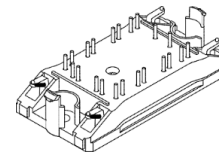
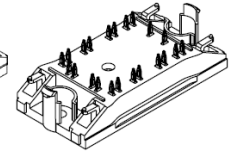

Figure 1. NXH100B120H3Q0xG/PG-R Schematic Diagram



Q0BOOST  
CASE 180AJ  
SOLDER PINS



Q0BOOST  
CASE 180BF  
PRESS-FIT PINS

### MARKING DIAGRAM

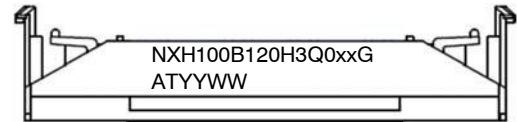

- xx = P, PT, S or ST
- YYWW = Year and Work Week Code
- A = Assembly Site Code
- T = Test Site Code
- G = Pb-Free Package

### PIN CONNECTIONS

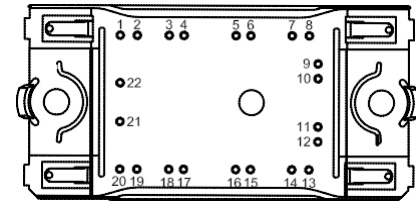

### ORDERING INFORMATION

See detailed ordering and shipping information on page 4 of this data sheet.

# NXH100B120H3Q0, NXH100B120H3Q0PG-R

## ABSOLUTE MAXIMUM RATINGS (Note 1) $T_J = 25^\circ\text{C}$ Unless Otherwise Noted

Rating	Symbol	Value	Unit
<b>BOOST IGBT</b>			
Collector–Emitter Voltage	$V_{CES}$	1200	V
Gate–Emitter Voltage	$V_{GE}$	$\pm 20$	V
Continuous Collector Current @ $T_C < 80^\circ\text{C}$ ( $T_J = 175^\circ\text{C}$ )	$I_{C1}$	61	A
Continuous Collector Current @ $T_C < 102^\circ\text{C}$ ( $T_J = 175^\circ\text{C}$ )	$I_{C2}$	50	A
Pulsed Collector Current ( $T_J = 175^\circ\text{C}$ )	$I_{Cpulse}$	150	A
Maximum Power Dissipation @ $T_C = 80^\circ\text{C}$ ( $T_J = 175^\circ\text{C}$ )	$P_{tot}$	186	W
Minimum Operating Junction Temperature	$T_{JMIN}$	-40	$^\circ\text{C}$
Maximum Operating Junction Temperature	$T_{JMAX}$	150	$^\circ\text{C}$

## BOOST DIODE

Peak Repetitive Reverse Voltage	$V_{RRM}$	1200	V
Continuous Forward Current @ $T_C < 80^\circ\text{C}$ ( $T_J = 175^\circ\text{C}$ )	$I_{F1}$	34	A
Continuous Forward Current @ $T_C < 132^\circ\text{C}$ ( $T_J = 175^\circ\text{C}$ )	$I_{F2}$	20	A
Maximum Power Dissipation @ $T_C = 80^\circ\text{C}$ ( $T_J = 175^\circ\text{C}$ )	$P_{tot}$	114	W
Surge Forward Current (60 Hz single half–sine wave)	$I_{FSM}$	185	A
$I^2t$ – value (60 Hz single half–sine wave)	$I^2t$	142	$\text{A}^2\text{s}$
Minimum Operating Junction Temperature	$T_{JMIN}$	-40	$^\circ\text{C}$
Maximum Operating Junction Temperature	$T_{JMAX}$	150	$^\circ\text{C}$

## BYPASS DIODE / IGBT PROTECTION DIODE

Peak Repetitive Reverse Voltage	$V_{RRM}$	1600	V
Continuous Forward Current @ $T_C < 80^\circ\text{C}$ ( $T_J = 175^\circ\text{C}$ )	$I_{F1}$	58	A
Continuous Forward Current @ $T_C < 141^\circ\text{C}$ ( $T_J = 175^\circ\text{C}$ )	$I_{F2}$	25	A
Repetitive Peak Forward Current ( $T_J = 175^\circ\text{C}$ , $t_p$ limited by $T_{Jmax}$ )	$I_{FRM}$	75	A
Maximum Power Dissipation @ $T_C = 80^\circ\text{C}$ ( $T_J = 175^\circ\text{C}$ )	$P_{tot}$	91	W
Minimum Operating Junction Temperature	$T_{JMIN}$	-40	$^\circ\text{C}$
Maximum Operating Junction Temperature	$T_{JMAX}$	150	$^\circ\text{C}$

## THERMAL PROPERTIES

Storage Temperature range	$T_{stg}$	-40 to 125	$^\circ\text{C}$
---------------------------	-----------	------------	------------------

## INSULATION PROPERTIES

Isolation test voltage, $t = 1$ sec, 60 Hz	$V_{is}$	3000	VRMS
Creepage distance		12.7	mm

Stresses exceeding those listed in the Maximum Ratings table may damage the device. If any of these limits are exceeded, device functionality should not be assumed, damage may occur and reliability may be affected.

1. Refer to ELECTRICAL CHARACTERISTICS, RECOMMENDED OPERATING RANGES and/or APPLICATION INFORMATION for Safe Operating parameters.

## RECOMMENDED OPERATING RANGES

Rating	Symbol	Min	Max	Unit
Module Operating Junction Temperature	$T_J$	-40	150	$^\circ\text{C}$

Functional operation above the stresses listed in the Recommended Operating Ranges is not implied. Extended exposure to stresses beyond the Recommended Operating Ranges limits may affect device reliability.

# NXH100B120H3Q0, NXH100B120H3Q0PG-R

## ELECTRICAL CHARACTERISTICS $T_J = 25^\circ\text{C}$ Unless Otherwise Noted

Parameter	Test Conditions	Symbol	Min	Typ	Max	Unit
<b>BOOST IGBT CHARACTERISTICS</b>						
Collector–Emitter Cutoff Current	$V_{GE} = 0\text{ V}, V_{CE} = 1200\text{ V}$	$I_{CES}$	–	–	200	$\mu\text{A}$
Collector–Emitter Saturation Voltage	$V_{GE} = 15\text{ V}, I_C = 50\text{ A}, T_J = 25^\circ\text{C}$	$V_{CE(sat)}$	–	1.77	2.3	V
	$V_{GE} = 15\text{ V}, I_C = 50\text{ A}, T_J = 150^\circ\text{C}$		–	1.93	–	
Gate–Emitter Threshold Voltage	$V_{GE} = V_{CE}, I_C = 1\text{ mA}$	$V_{GE(TH)}$	4.6	5.27	6.5	V
Gate Leakage Current	$V_{GE} = 20\text{ V}, V_{CE} = 0\text{ V}$	$I_{GES}$	–	–	800	nA
Turn–on Delay Time	$T_J = 25^\circ\text{C}$ $V_{CE} = 700\text{ V}, I_C = 50\text{ A}, V_{GE} = \pm 15\text{ V},$ $R_G = 4\ \Omega$	$t_{d(on)}$	–	44	–	ns
Rise Time		$t_r$	–	16	–	
Turn–off Delay Time		$t_{d(off)}$	–	203	–	
Fall Time		$t_f$	–	23	–	
Turn–on Switching Loss per Pulse		$E_{on}$	–	700	–	
Turn–off Switching Loss per Pulse		$E_{off}$	–	1500	–	
Turn–on Delay Time	$T_J = 125^\circ\text{C}$ $V_{CE} = 700\text{ V}, I_C = 50\text{ A}, V_{GE} = \pm 15\text{ V},$ $R_G = 4\ \Omega$	$t_{d(on)}$	–	43	–	ns
Rise Time		$t_r$	–	18	–	
Turn–off Delay Time		$t_{d(off)}$	–	233	–	
Fall Time		$t_f$	–	58	–	
Turn–on Switching Loss per Pulse		$E_{on}$	–	800	–	
Turn–off Switching Loss per Pulse		$E_{off}$	–	2600	–	
Input Capacitance	$V_{CE} = 20\text{ V}, V_{GE} = 0\text{ V}, f = 10\text{ kHz}$	$C_{ies}$	–	9075	–	pF
Output Capacitance		$C_{oes}$	–	173	–	
Reverse Transfer Capacitance		$C_{res}$	–	147	–	
Total Gate Charge	$V_{CE} = 600\text{ V}, I_C = 40\text{ A}, V_{GE} = 15\text{ V}$	$Q_g$	–	409	–	nC
Thermal Resistance – chip–to–case		$R_{thJC}$	–	0.51	–	$^\circ\text{C/W}$
Thermal Resistance – chip–to–heatsink	Thermal grease, Thickness $\approx 100\ \mu\text{m}$ , $\lambda = 2.87\text{ W/mK}$	$R_{thJH}$	–	0.82	–	$^\circ\text{C/W}$

## BOOST DIODE CHARACTERISTICS

Diode Reverse Leakage Current	$V_R = 1200\text{ V}$	$I_R$	–	–	300	$\mu\text{A}$
Diode Forward Voltage	$I_F = 20\text{ A}, T_J = 25^\circ\text{C}$	$V_F$	–	1.44	1.8	V
	$I_F = 20\text{ A}, T_J = 150^\circ\text{C}$		–	1.93	–	
Reverse Recovery Time	$T_J = 25^\circ\text{C}$ $V_{CE} = 700\text{ V}, I_C = 50\text{ A}, V_{GE} = \pm 15\text{ V},$ $R_G = 4\ \Omega$	$t_{rr}$	–	15	–	ns
Reverse Recovery Charge		$Q_{rr}$	–	108	–	nC
Peak Reverse Recovery Current		$I_{RRM}$	–	11	–	A
Peak Rate of Fall of Recovery Current		$di/dt$	–	1500	–	$\text{A}/\mu\text{s}$
Reverse Recovery Energy		$E_{rr}$	–	20	–	$\mu\text{J}$
Reverse Recovery Time		$T_J = 125^\circ\text{C}$ $V_{CE} = 700\text{ V}, I_C = 50\text{ A}, V_{GE} = \pm 15\text{ V},$ $R_G = 4\ \Omega$	$t_{rr}$	–	16	–
Reverse Recovery Charge	$Q_{rr}$		–	115	–	nC
Peak Reverse Recovery Current	$I_{RRM}$		–	12	–	A
Peak Rate of Fall of Recovery Current	$di/dt$		–	1400	–	$\text{A}/\mu\text{s}$
Reverse Recovery Energy	$E_{rr}$		–	22	–	$\mu\text{J}$
Thermal Resistance – chip–to–case			$R_{thJC}$	–	0.83	–
Thermal Resistance – chip–to–heatsink	Thermal grease, Thickness $\approx 100\ \mu\text{m}$ , $\lambda = 2.87\text{ W/mK}$	$R_{thJH}$	–	1.15	–	$^\circ\text{C/W}$

# NXH100B120H3Q0, NXH100B120H3Q0PG-R

## ELECTRICAL CHARACTERISTICS $T_J = 25^\circ\text{C}$ Unless Otherwise Noted

Parameter	Test Conditions	Symbol	Min	Typ	Max	Unit
<b>BYPASS DIODE/IGBT PROTECTION DIODE CHARACTERISTICS</b>						
Diode Reverse Leakage Current	$V_R = 1600\text{ V}, T_J = 25^\circ\text{C}$	$I_R$	–	–	100	$\mu\text{A}$
Diode Forward Voltage	$I_F = 25\text{ A}, T_J = 25^\circ\text{C}$	$V_F$	–	1.0	1.4	V
	$I_F = 25\text{ A}, T_J = 150^\circ\text{C}$		–	0.90	–	
Thermal Resistance – chip-to-case		$R_{thJC}$	–	1.04	–	$^\circ\text{C/W}$
Thermal Resistance – chip-to-heatsink	Thermal grease, Thickness $\approx 100\ \mu\text{m}$ , $\lambda = 2.87\text{ W/mK}$	$R_{thJH}$	–	1.41	–	$^\circ\text{C/W}$

## THERMISTOR CHARACTERISTICS

Nominal resistance		$R_{25}$	–	22	–	$\text{k}\Omega$
Nominal resistance	$T = 100^\circ\text{C}$	$R_{100}$	–	1486	–	$\Omega$
Deviation of $R_{25}$		$\Delta R/R$	–5	–	5	%
Power dissipation		$P_D$	–	200	–	mW
Power dissipation constant			–	2	–	mW/K
B-value	B(25/50), tolerance $\pm 3\%$		–	3950	–	K
B-value	B(25/100), tolerance $\pm 3\%$		–	3998	–	K

Product parametric performance is indicated in the Electrical Characteristics for the listed test conditions, unless otherwise noted. Product performance may not be indicated by the Electrical Characteristics if operated under different conditions.

## ORDERING INFORMATION

Orderable Part Number	Marking	Package	Shipping
NXH100B120H3Q0PG, NXH100B120H3Q0PG-R	NXH100B120H3Q0PG, NXH100B120H3Q0PG-R	Q0BOOST – Case 180BF (Pb-Free and Halide-Free) Press-Fit Pins	24 Units / Blister Tray
NXH100B120H3Q0SG	NXH100B120H3Q0SG	Q0BOOST – Case 180AJ (Pb-Free and Halide-Free) Solder Pins	24 Units / Blister Tray
NXH100B120H3Q0PTG	NXH100B120H3Q0PTG	Q0BOOST – Case 180BF (Pb-Free and Halide-Free) Press-Fit Pins, Thermal Interface Material (TIM)	24 Units / Blister Tray
NXH100B120H3Q0STG	NXH100B120H3Q0STG	Q0BOOST – Case 180AJ (Pb-Free and Halide-Free) Solder Pins, Thermal Interface Material (TIM)	24 Units / Blister Tray

# NXH100B120H3Q0, NXH100B120H3Q0PG-R

## TYPICAL CHARACTERISTICS Boost IGBT & IGBT Protection Diode / Bypass Diode

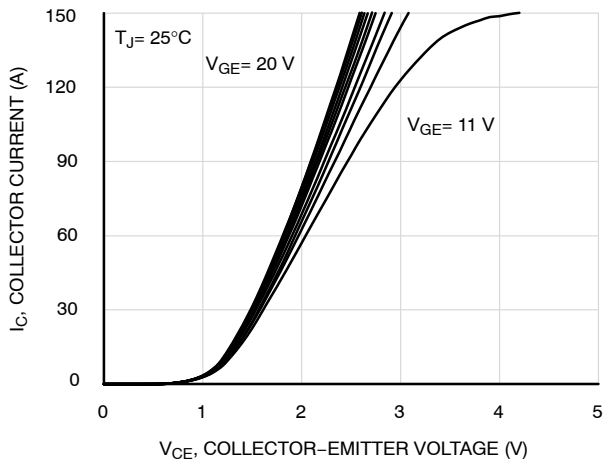

Figure 2. IGBT Typical Output Characteristics

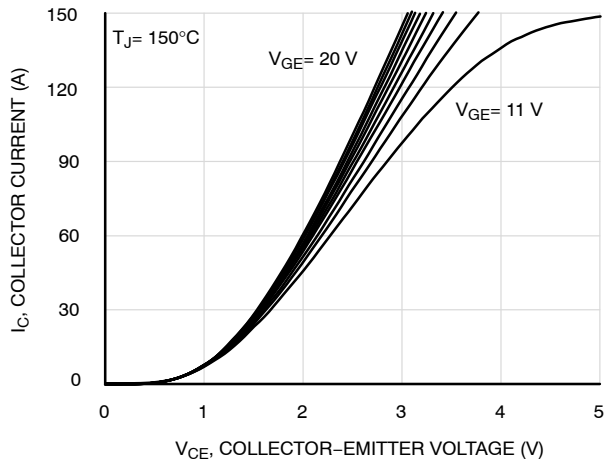

Figure 3. IGBT Typical Output Characteristics

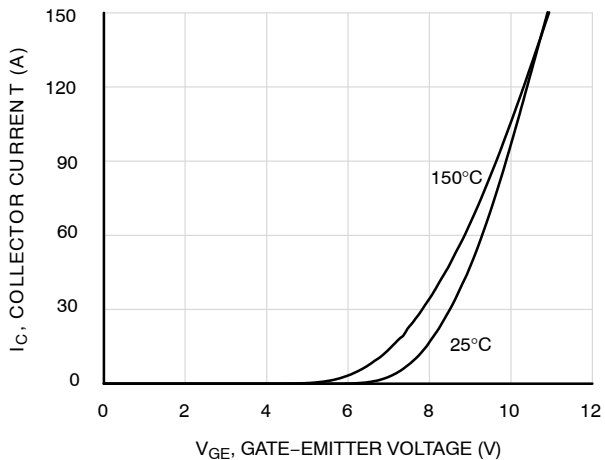

Figure 4. IGBT Typical Transfer Characteristics

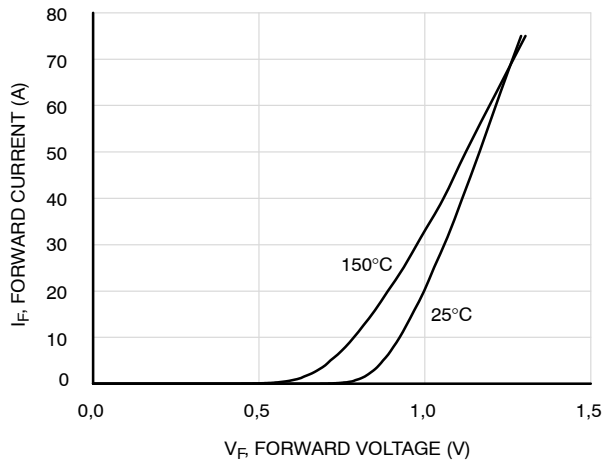

Figure 5. Diode Forward Characteristics

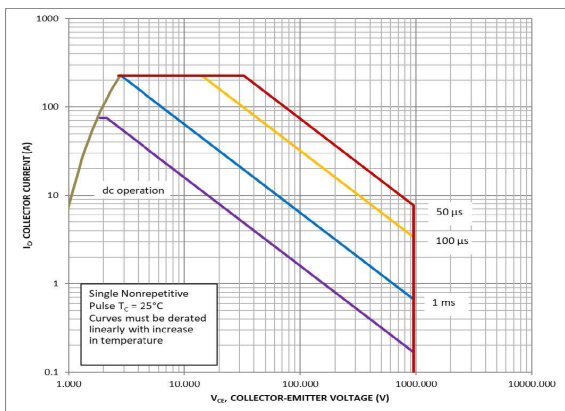

Figure 6. FBSOA

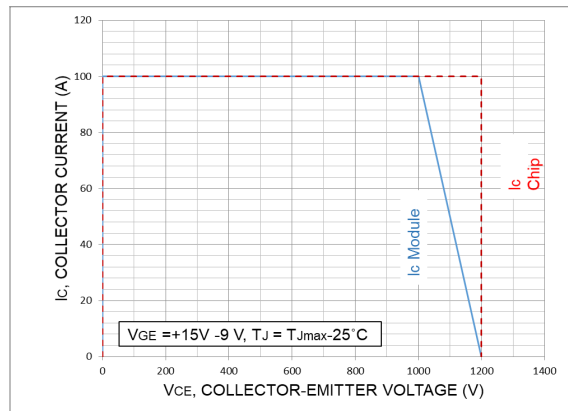

Figure 7. RBSOA

# NXH100B120H3Q0, NXH100B120H3Q0PG-R

## TYPICAL CHARACTERISTICS Boost IGBT & IGBT Protection Diode / Bypass Diode

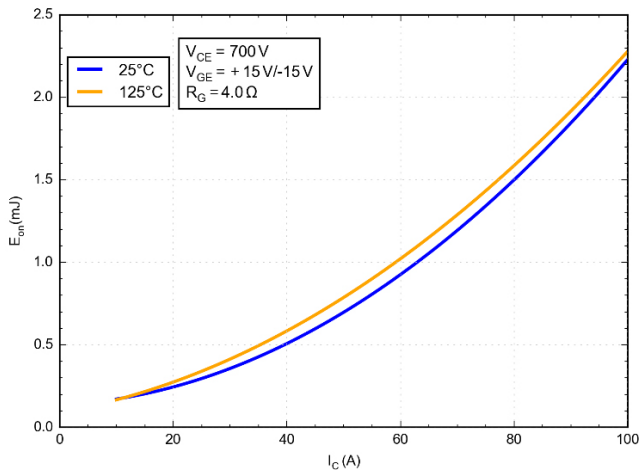

Figure 8. Typical Switching Loss Eon vs. IC

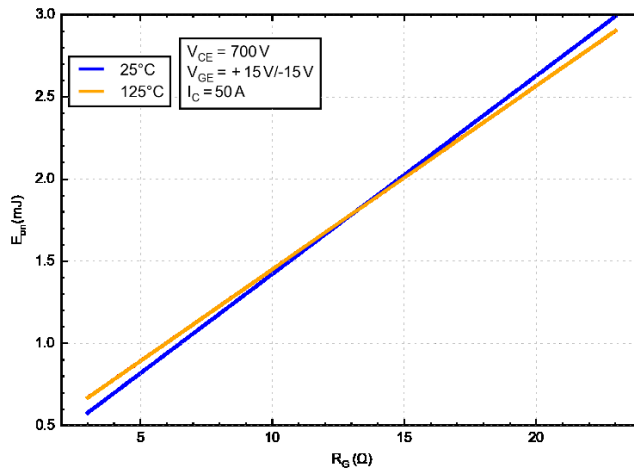

Figure 9. Typical Switching Loss Eon vs.  $R_G$

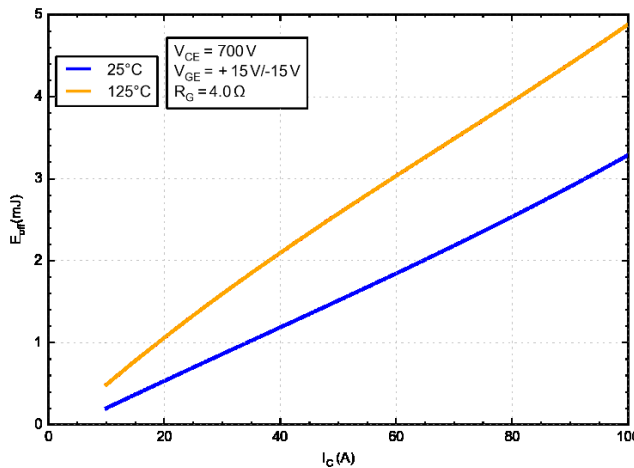

Figure 10. Typical Switching Loss Eoff vs. IC

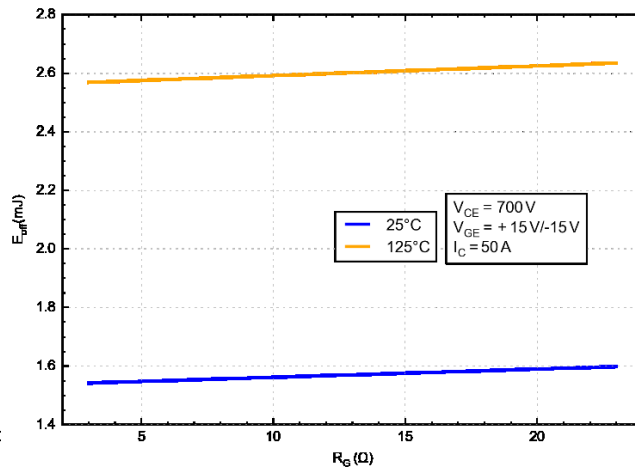

Figure 11. Typical Switching Loss Eoff vs.  $R_G$

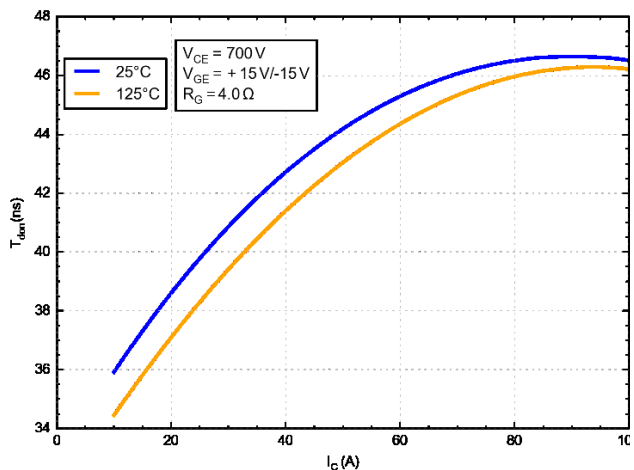

Figure 12. Typical Switching Time Tdon vs. IC

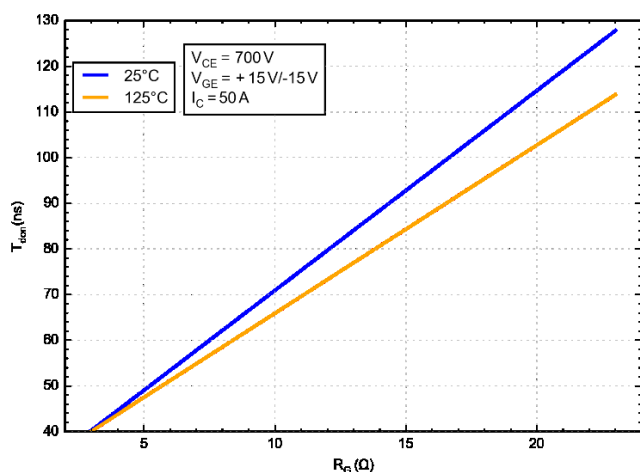

Figure 13. Typical Switching Time Tdon vs.  $R_G$

# NXH100B120H3Q0, NXH100B120H3Q0PG-R

## TYPICAL PERFORMANCE CHARACTERISTICS

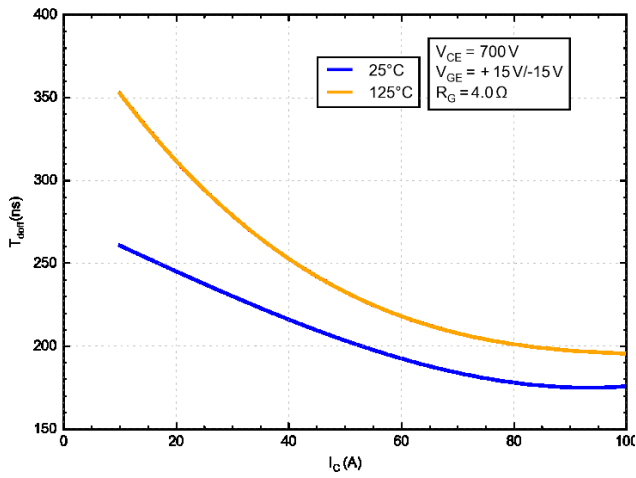

Figure 14. Typical Switching Time Tdoff vs. IC

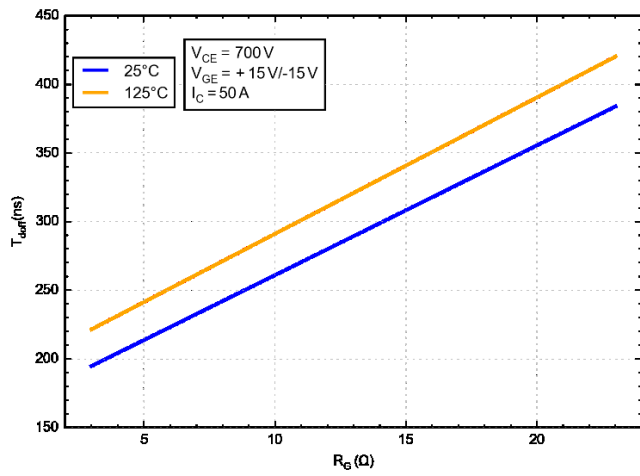

Figure 15. Typical Switching Time Tdoff vs.  $R_G$

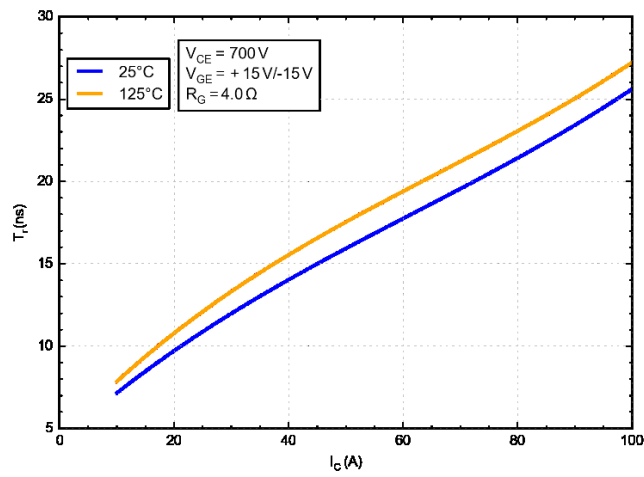

Figure 16. Typical Switching Time Tron vs. IC

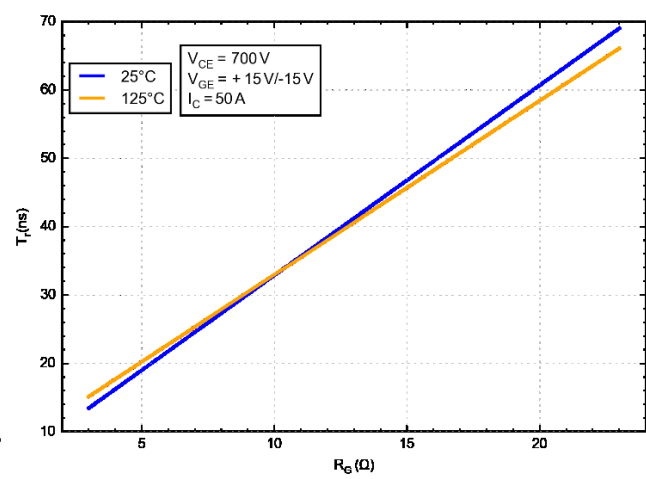

Figure 17. Typical Switching Time Tron vs.  $R_G$

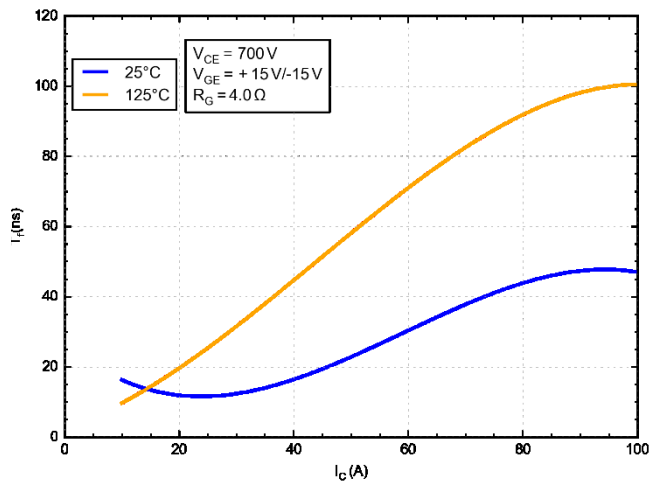

Figure 18. Typical Switching Time Tf vs. IC

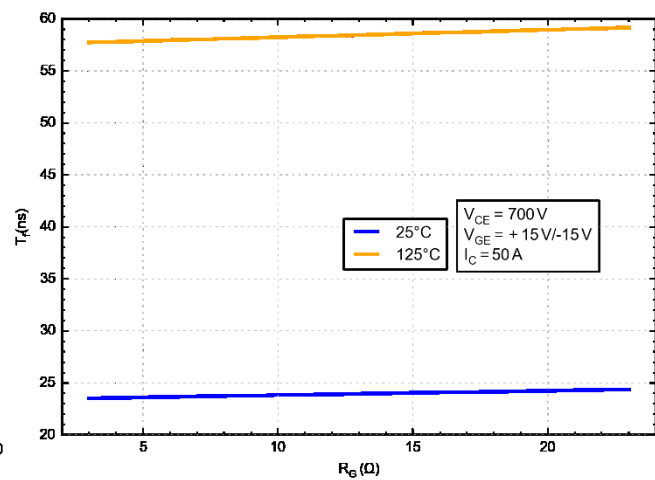

Figure 19. Typical Switching Time Tf vs.  $R_G$

# NXH100B120H3Q0, NXH100B120H3Q0PG-R

## TYPICAL PERFORMANCE CHARACTERISTICS

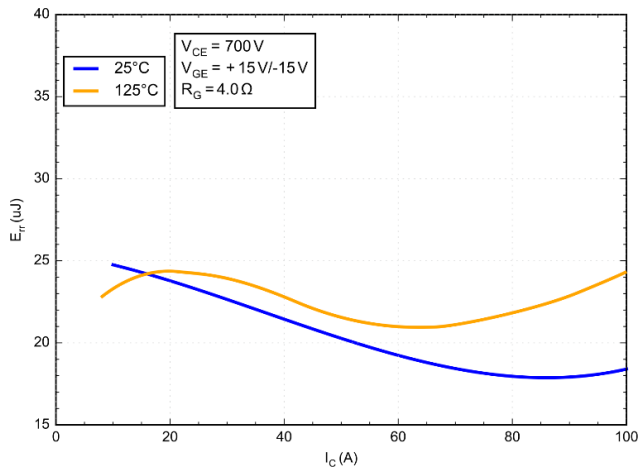

Figure 20. Typical Reverse Recovery Energy vs. IC

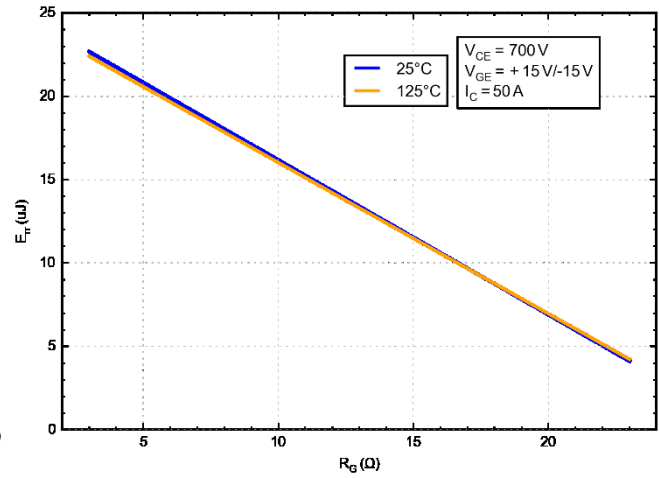

Figure 21. Typical Reverse Recovery Energy vs. RG

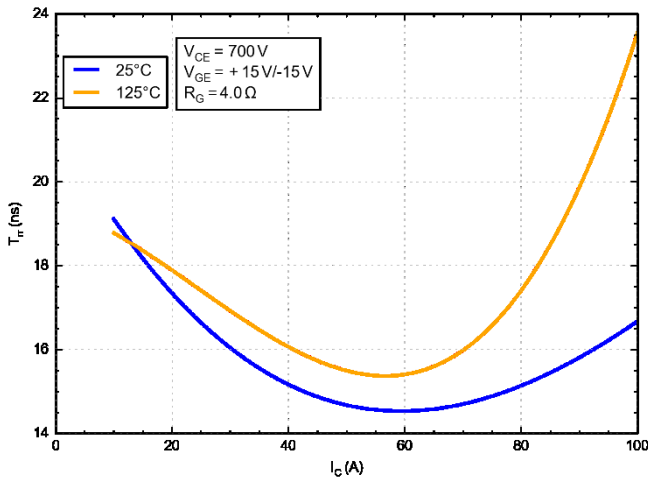

Figure 22. Typical Reverse Recovery Time vs. IC

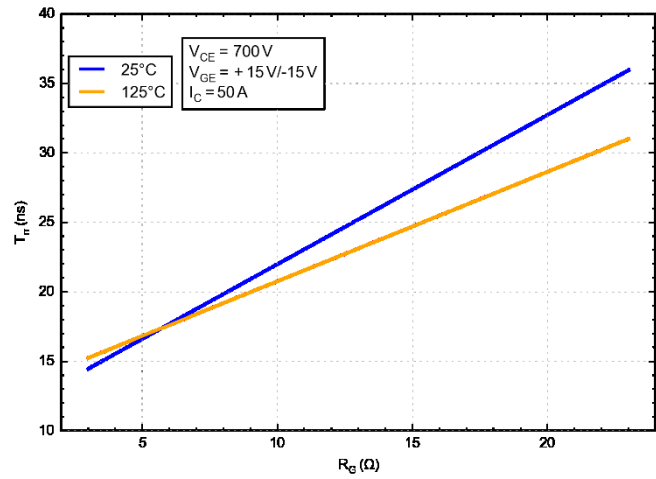

Figure 23. Typical Reverse Recovery Time vs. RG

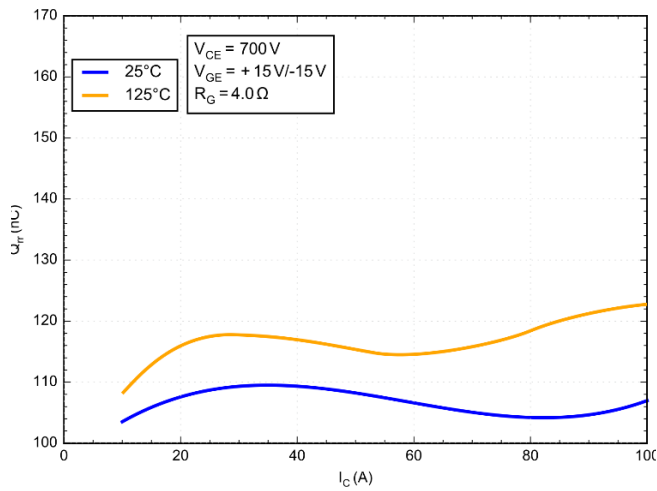

Figure 24. Typical Reverse Recovery Charge vs. IC

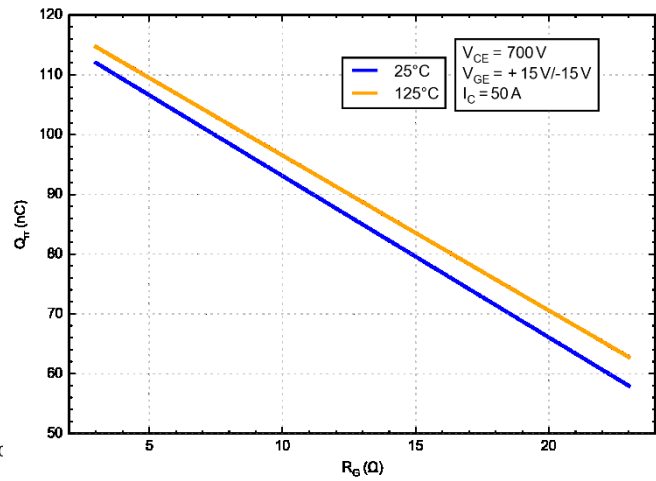

Figure 25. Typical Reverse Recovery Charge vs. RG



# NXH100B120H3Q0, NXH100B120H3Q0PG-R

## TYPICAL PERFORMANCE CHARACTERISTICS

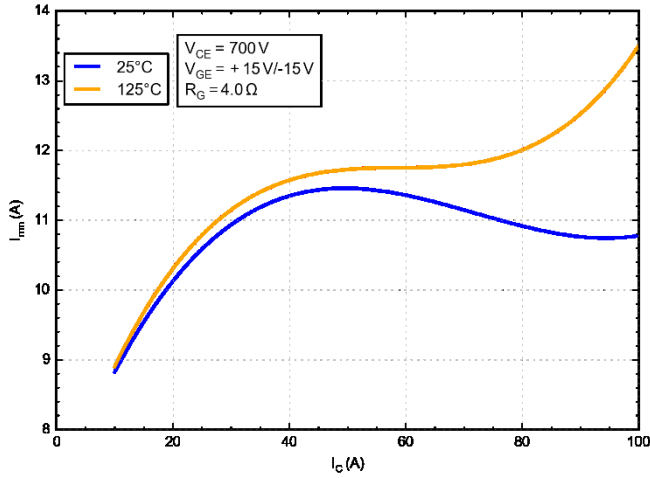

Figure 26. Typical Reverse Recovery Current vs. IC

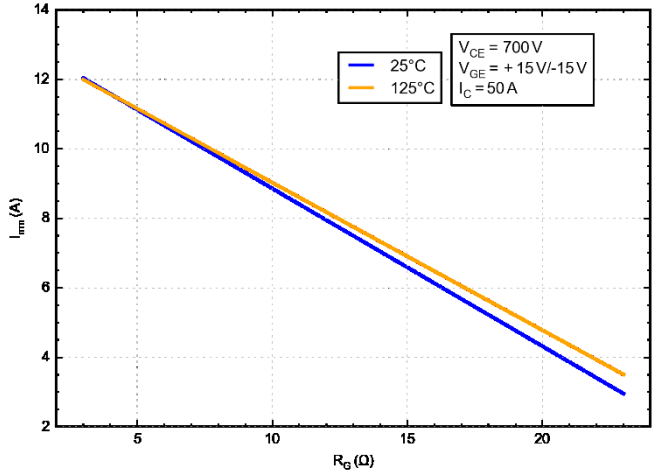

Figure 27. Typical Reverse Recovery Current vs. RG

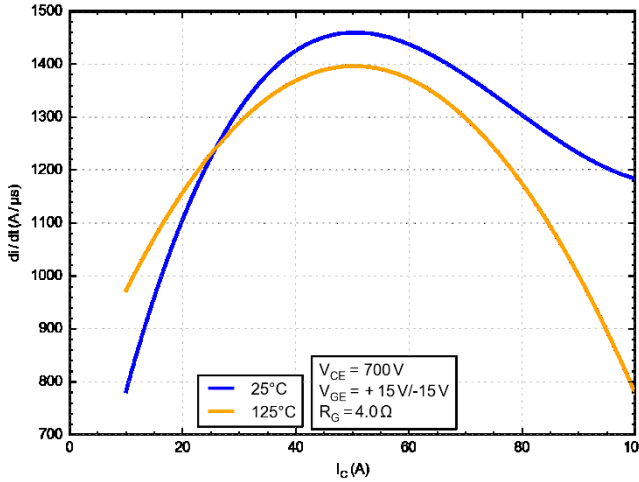

Figure 28. Typical di/dt vs. IC

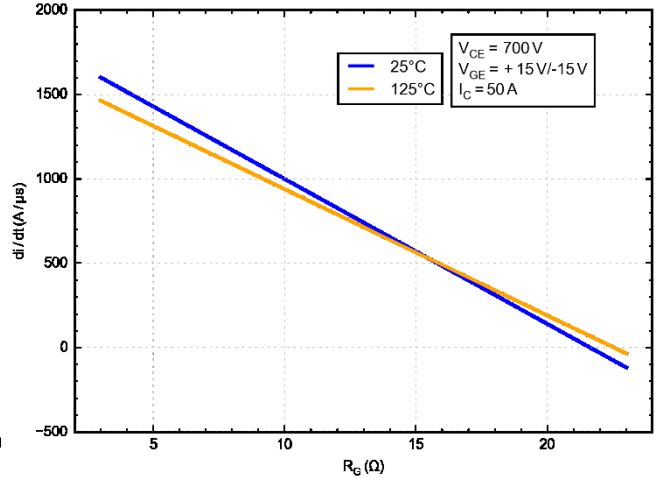

Figure 29. Typical di/dt vs. RG

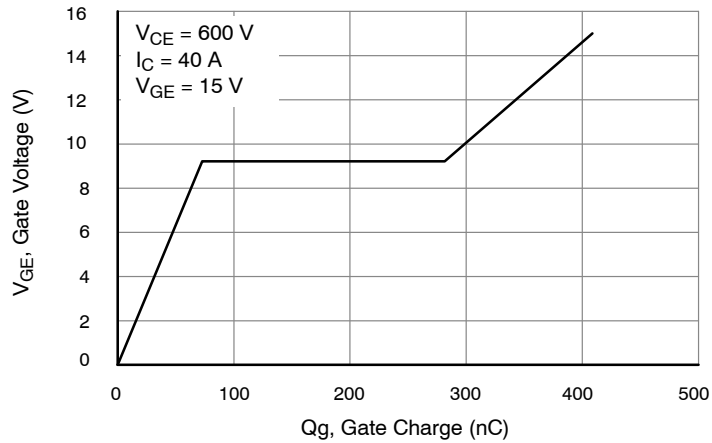

Figure 30. Gate Voltage vs. Gate Charge

# NXH100B120H3Q0, NXH100B120H3Q0PG-R

## TYPICAL PERFORMANCE CHARACTERISTICS

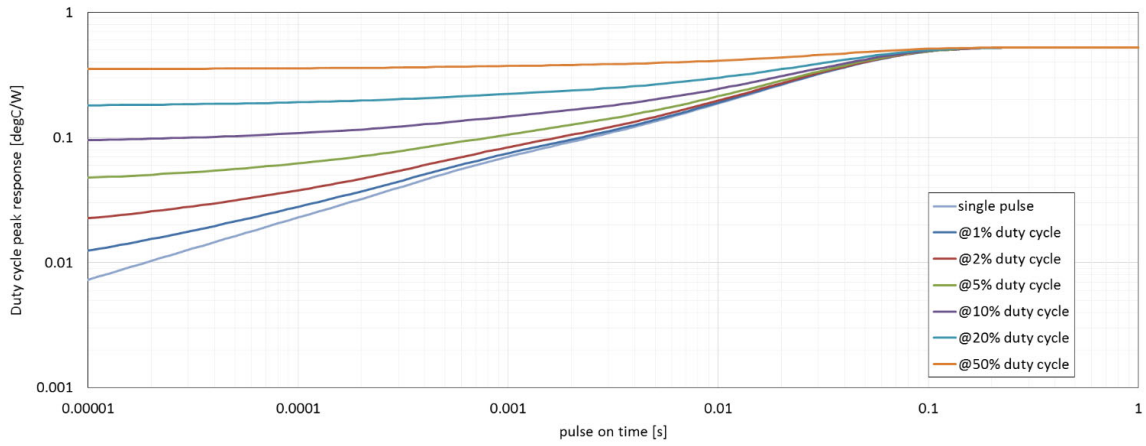

Figure 31. IGBT Junction-to-Case Transient Thermal Impedance

# NXH100B120H3Q0, NXH100B120H3Q0PG-R

## TYPICAL PERFORMANCE CHARACTERISTICS – Boost Diode

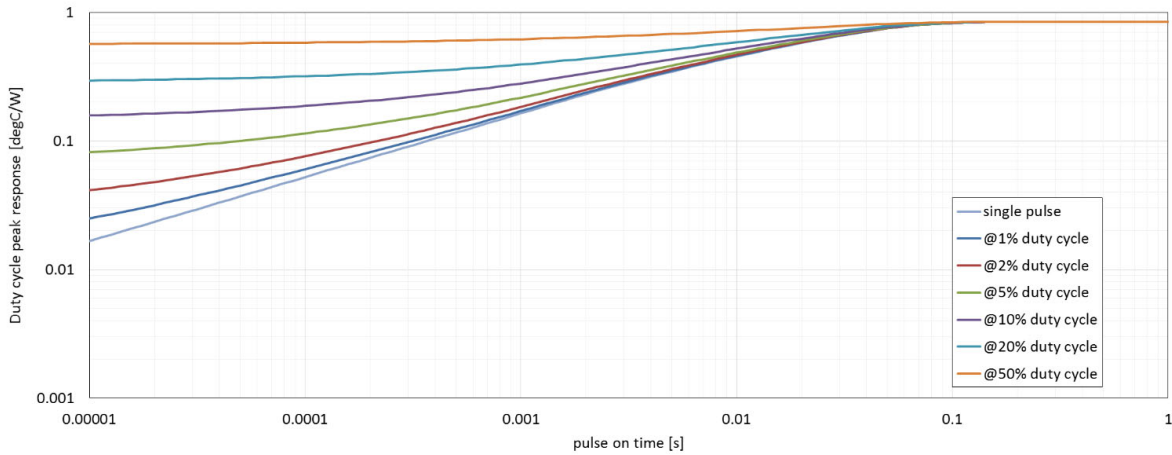

Figure 32. Diode Junction-to-Case Transient Thermal Impedance

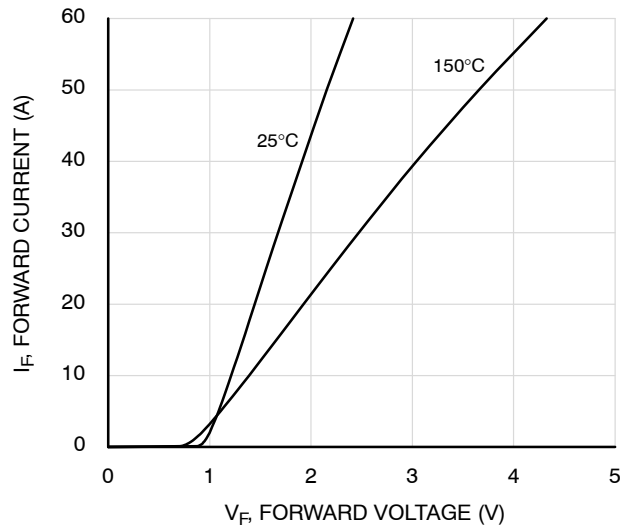

Figure 33. Diode Forward Characteristic

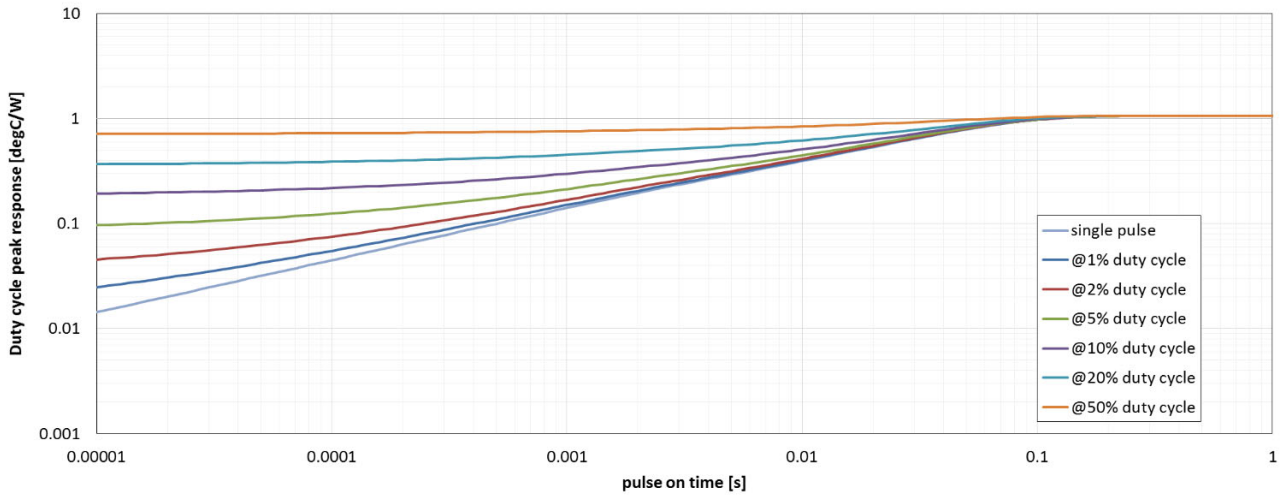

Figure TBD: Transient Thermal Impedance

Figure 34. Diode Junction-to-Case Transient Thermal Impedance

# MECHANICAL CASE OUTLINE

## PACKAGE DIMENSIONS

ON Semiconductor®



### PIM22, 55x32.5 / Q0BOOST CASE 180AJ ISSUE B

DATE 08 NOV 2017

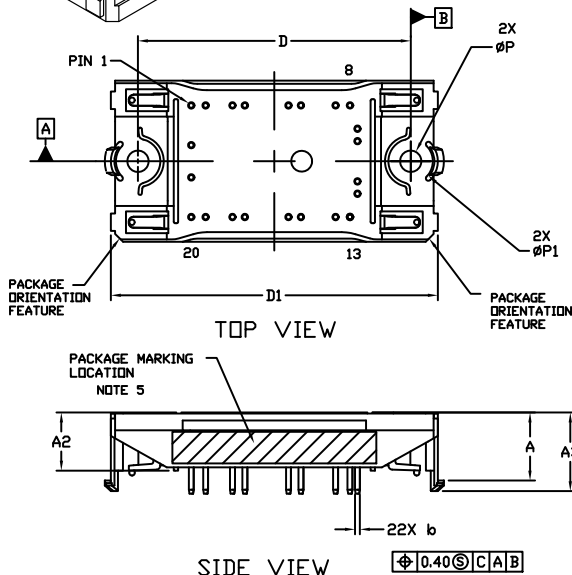
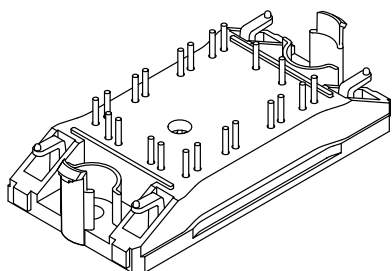

**NOTES:**

1. DIMENSIONING AND TOLERANCING PER ASME Y14.5M, 2009.
2. CONTROLLING DIMENSION: MILLIMETERS
3. DIMENSION b APPLIES TO THE PLATED TERMINALS AND IS MEASURED BETWEEN 1.00 AND 3.00 FROM THE TERMINAL TIP.
4. POSITION OF THE CENTER OF THE TERMINALS IS DETERMINED FROM DATUM B THE CENTER OF DIMENSION D, X DIRECTION, AND FROM DATUM A, Y DIRECTION. POSITIONAL TOLERANCE, AS NOTED IN DRAWING, APPLIES TO EACH TERMINAL IN BOTH DIRECTIONS.
5. PACKAGE MARKING IS LOCATED AS SHOWN ON THE SIDE OPPOSITE THE PACKAGE ORIENTATION FEATURES.

DIM	MILLIMETERS	
	MIN.	NDM.
A	13.50	13.90
A1	0.10	0.30
A2	11.50	11.90
A3	15.65	16.05
A4	16.35	REF
b	0.95	1.05
D	54.80	55.20
D1	65.60	66.20
E	32.20	32.80
P	4.20	4.40
P1	8.90	9.10

**MOUNTING HOLE POSITION**

NOTE 4

PIN	HOLE POSITION		PIN	PIN POSITION		PIN	PIN POSITION		PIN	PIN POSITION	
	X	Y		X	Y		X	Y		X	Y
1	-16.75	-11.25	12	16.75	6.55	1	-16.75	11.25	12	16.75	-6.55
2	-13.85	-11.25	13	15.25	11.25	2	-13.85	11.25	13	15.25	-11.25
3	-8.45	-11.25	14	12.35	11.25	3	-8.45	11.25	14	12.35	-11.25
4	-5.95	-11.25	15	5.35	11.25	4	-5.95	11.25	15	5.35	-11.25
5	2.85	-11.25	16	2.85	11.25	5	2.85	11.25	16	2.85	-11.25
6	5.35	-11.25	17	-5.95	11.25	6	5.35	11.25	17	-5.95	-11.25
7	12.35	-11.25	18	-8.45	11.25	7	12.35	11.25	18	-8.45	-11.25
8	15.25	-11.25	19	-13.85	11.25	8	15.25	11.25	19	-13.85	-11.25
9	16.75	-6.55	20	-16.75	11.25	9	16.75	6.55	20	-16.75	-11.25
10	16.75	-4.05	21	-16.75	3.25	10	16.75	4.05	21	-16.75	-3.25
11	16.75	4.05	22	-16.75	-3.25	11	16.75	-4.05	22	-16.75	3.25

**GENERIC MARKING DIAGRAM\***

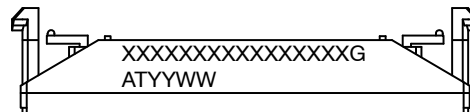

XXXXX = Specific Device Code  
 G = Pb-Free Package  
 AT = Assembly & Test Site Code  
 YYWW = Year and Work Week Code

\*This information is generic. Please refer to device data sheet for actual part marking. Pb-Free indicator, "G" or microdot "•", may or may not be present. Some products may not follow the Generic Marking.

<b>DOCUMENT NUMBER:</b>	<b>98AON63481G</b>	Electronic versions are uncontrolled except when accessed directly from the Document Repository. Printed versions are uncontrolled except when stamped "CONTROLLED COPY" in red.
<b>DESCRIPTION:</b>	<b>PIM22 55X32.5 / Q0BOOST (SOLDER PIN)</b>	<b>PAGE 1 OF 2</b>

ON Semiconductor and ON are trademarks of Semiconductor Components Industries, LLC dba ON Semiconductor or its subsidiaries in the United States and/or other countries. ON Semiconductor reserves the right to make changes without further notice to any products herein. ON Semiconductor makes no warranty, representation or guarantee regarding the suitability of its products for any particular purpose, nor does ON Semiconductor assume any liability arising out of the application or use of any product or circuit, and specifically disclaims any and all liability, including without limitation special, consequential or incidental damages. ON Semiconductor does not convey any license under its patent rights nor the rights of others.

PIM22, 55x32.5 / Q0BOOST  
CASE 180AJ  
ISSUE B

DATE 08 NOV 2017

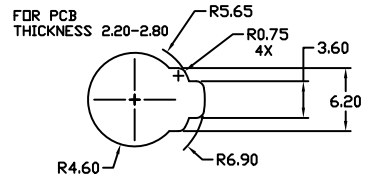
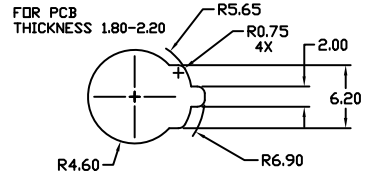
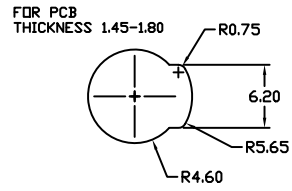
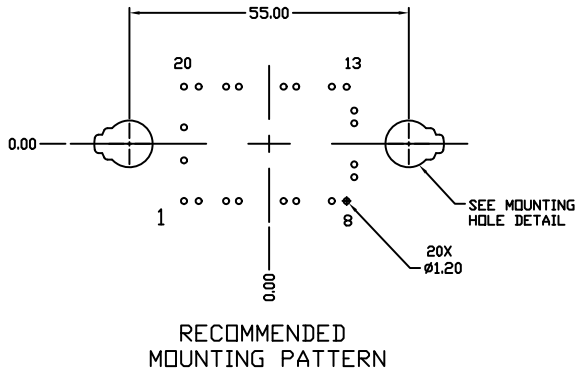

MOUNTING HOLE DETAIL

<b>DOCUMENT NUMBER:</b>	<b>98AON63481G</b>	Electronic versions are uncontrolled except when accessed directly from the Document Repository. Printed versions are uncontrolled except when stamped "CONTROLLED COPY" in red.
<b>DESCRIPTION:</b>	<b>PIM22 55X32.5 / Q0BOOST (SOLDER PIN)</b>	<b>PAGE 2 OF 2</b>

ON Semiconductor and  are trademarks of Semiconductor Components Industries, LLC dba ON Semiconductor or its subsidiaries in the United States and/or other countries. ON Semiconductor reserves the right to make changes without further notice to any products herein. ON Semiconductor makes no warranty, representation or guarantee regarding the suitability of its products for any particular purpose, nor does ON Semiconductor assume any liability arising out of the application or use of any product or circuit, and specifically disclaims any and all liability, including without limitation special, consequential or incidental damages. ON Semiconductor does not convey any license under its patent rights nor the rights of others.

# MECHANICAL CASE OUTLINE

## PACKAGE DIMENSIONS

ON Semiconductor®



### PIM22 55x32.5 (PRESSFIT PIN) CASE 180BF ISSUE O

DATE 21 MAY 2019

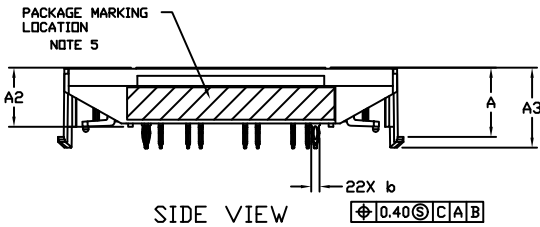
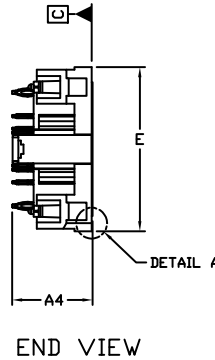
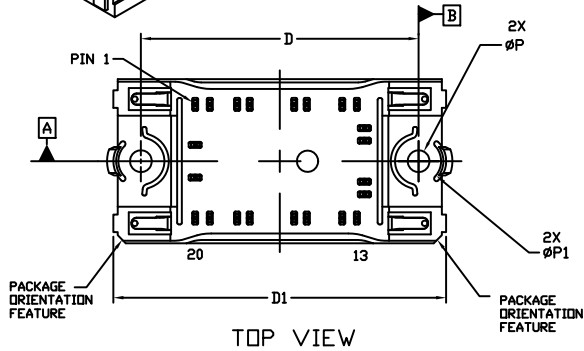
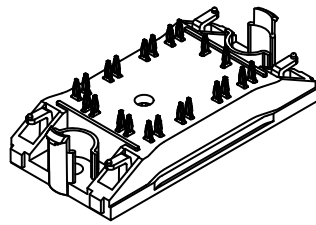

NOTES:

1. DIMENSIONING AND TOLERANCING PER ASME Y14.5M, 2009.
2. CONTROLLING DIMENSION: MILLIMETERS
3. DIMENSION *b* APPLIES TO THE PLATED TERMINALS AND IS MEASURED BETWEEN 1.00 AND 3.00 FROM THE TERMINAL TIP.
4. POSITION OF THE CENTER OF THE TERMINALS IS DETERMINED FROM DATUM B THE CENTER OF DIMENSION D, X DIRECTION, AND FROM DATUM A, Y DIRECTION. POSITIONAL TOLERANCE, AS NOTED IN DRAWING, APPLIES TO EACH TERMINAL IN BOTH DIRECTIONS.
5. PACKAGE MARKING IS LOCATED AS SHOWN ON THE SIDE OPPOSITE THE PACKAGE ORIENTATION FEATURES.

DIM	MILLIMETERS		
	MIN.	NDM.	MAX.
A	13.50	13.70	13.90
A1	0.10	0.20	0.30
A2	11.50	11.70	11.90
A3	15.65	15.85	16.05
A4	15.95 REF		
<i>b</i>	1.61	1.66	1.71
D	54.80	55.00	55.20
D1	65.60	65.90	66.20
E	32.20	32.50	32.80
P	4.20	4.30	4.40
P1	8.90	9.00	9.10

NOTE 4

PIN	PIN POSITION		PIN	PIN POSITION	
	X	Y		X	Y
1	-16.75	11.25	12	16.75	-6.55
2	-13.85	11.25	13	15.25	-11.25
3	-8.45	11.25	14	12.35	-11.25
4	-5.95	11.25	15	5.35	-11.25
5	2.85	11.25	16	2.85	-11.25
6	5.35	11.25	17	-5.95	-11.25
7	12.35	11.25	18	-8.45	-11.25
8	15.25	11.25	19	-13.85	-11.25
9	16.75	6.55	20	-16.75	-11.25
10	16.75	4.05	21	-16.75	-3.25
11	16.75	-4.05	22	-16.75	3.25

DOCUMENT NUMBER:	98AON07824H	Electronic versions are uncontrolled except when accessed directly from the Document Repository. Printed versions are uncontrolled except when stamped "CONTROLLED COPY" in red.
DESCRIPTION:	PIM22 55x32.5 (PRESSFIT PIN)	PAGE 1 OF 2

ON Semiconductor and ON are trademarks of Semiconductor Components Industries, LLC dba ON Semiconductor or its subsidiaries in the United States and/or other countries. ON Semiconductor reserves the right to make changes without further notice to any products herein. ON Semiconductor makes no warranty, representation or guarantee regarding the suitability of its products for any particular purpose, nor does ON Semiconductor assume any liability arising out of the application or use of any product or circuit, and specifically disclaims any and all liability, including without limitation special, consequential or incidental damages. ON Semiconductor does not convey any license under its patent rights nor the rights of others.

**PIM22 55x32.5 (PRESSFIT PIN)**  
**CASE 180BF**  
**ISSUE O**

DATE 17 MAY 2019

**MOUNTING HOLE POSITION**

PIN	HOLE POSITION		PIN	PIN POSITION	
	X	Y		X	Y
1	-16.75	-11.25	12	16.75	6.55
2	-13.85	-11.25	13	15.25	11.25
3	-8.45	-11.25	14	12.35	11.25
4	-5.95	-11.25	15	5.35	11.25
5	2.85	-11.25	16	2.85	11.25
6	5.35	-11.25	17	-5.95	11.25
7	12.35	-11.25	18	-8.45	11.25
8	15.25	-11.25	19	-13.85	11.25
9	16.75	-6.55	20	-16.75	11.25
10	16.75	-4.05	21	-16.75	3.25
11	16.75	4.05	22	-16.75	-3.25

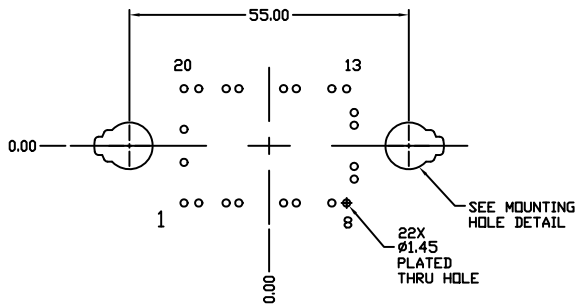

**RECOMMENDED  
MOUNTING PATTERN**

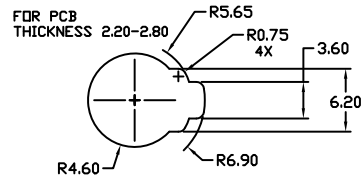
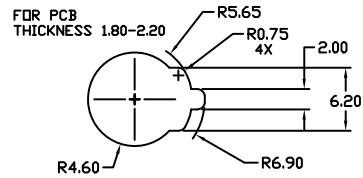
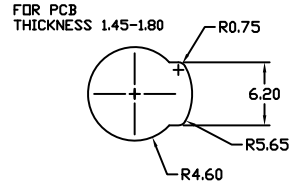

**MOUNTING HOLE DETAIL**

**GENERIC  
MARKING DIAGRAM\***

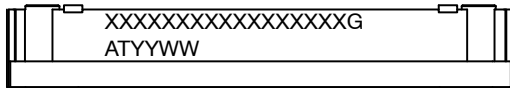

XXXXX = Specific Device Code  
 G = Pb-Free Package  
 AT = Assembly & Test Site Code  
 YYWW = Year and Work Week Code

\*This information is generic. Please refer to device data sheet for actual part marking. Pb-Free indicator, "G" or microdot "•", may or may not be present. Some products may not follow the Generic Marking.

<b>DOCUMENT NUMBER:</b>	<b>98AON07824H</b>	Electronic versions are uncontrolled except when accessed directly from the Document Repository. Printed versions are uncontrolled except when stamped "CONTROLLED COPY" in red.
<b>DESCRIPTION:</b>	<b>PIM22 55x32.5 (PRESSFIT PIN)</b>	<b>PAGE 2 OF 2</b>

ON Semiconductor and are trademarks of Semiconductor Components Industries, LLC dba ON Semiconductor or its subsidiaries in the United States and/or other countries. ON Semiconductor reserves the right to make changes without further notice to any products herein. ON Semiconductor makes no warranty, representation or guarantee regarding the suitability of its products for any particular purpose, nor does ON Semiconductor assume any liability arising out of the application or use of any product or circuit, and specifically disclaims any and all liability, including without limitation special, consequential or incidental damages. ON Semiconductor does not convey any license under its patent rights nor the rights of others.