

# OA180AP IP69K Series

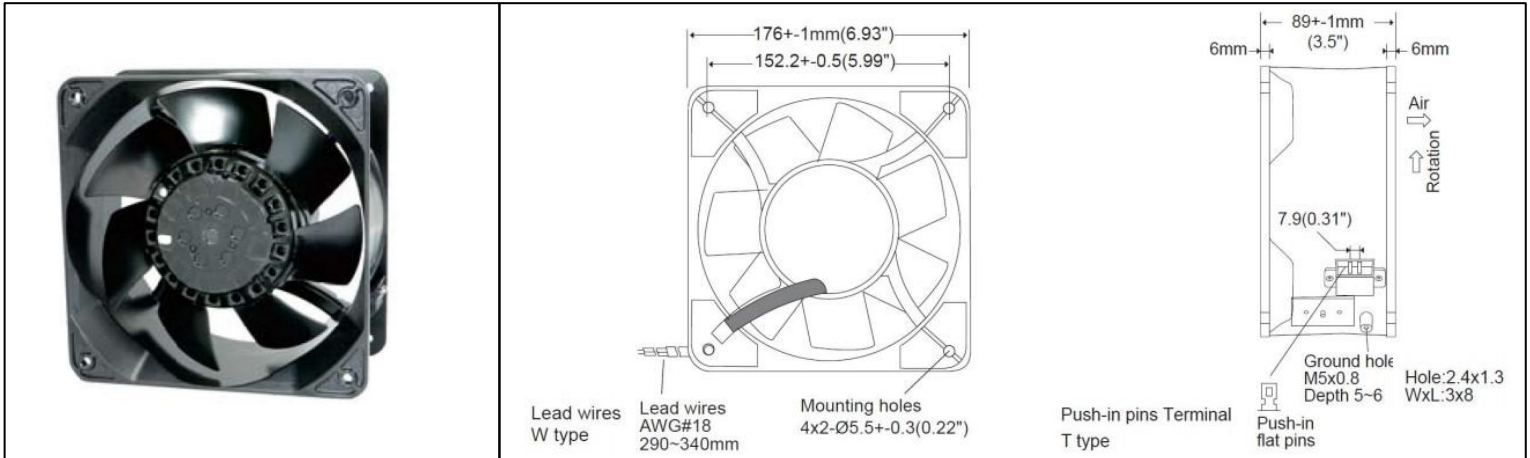

AC Fans - 115, 230V  
176mm x 89mm (7.1" x 3.5")



<b>Frame</b>	Die Cast Aluminum, Black Finish	<b>Operating Temperature</b> -30°C ~ +80°C  <b>Storage Temperature</b> -40°C ~ +100°C  <b>Life Expectancy</b> 50,000 Hours (L10 at 55°C)  Weight: 4.08 lbs
<b>Impeller</b>	Steel, All Metal, 7 Blades	
<b>Connection</b>	Lead Wires, 18 AWG, or Terminals	
<b>Motor</b>	AC, Outer Rotor, Capacitor Induction, Single Phase, Thermally Protected, IP69K	
<b>Bearing System</b>	Ball Bearings	
<b>Dielectric Strength</b>	1500VAC/min, <5mA	
<b>Insulation Resistance</b>	≥10MΩ @ 500V DC	

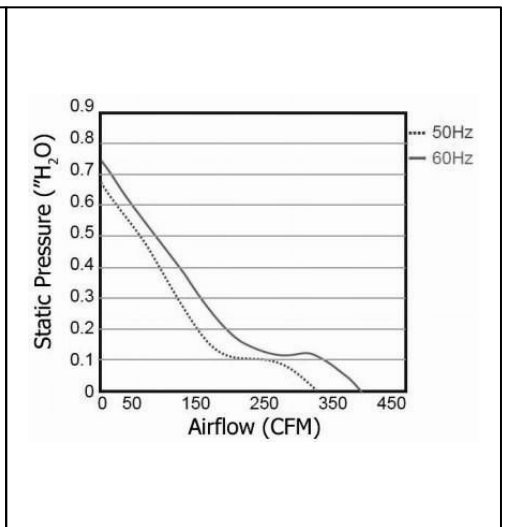

Part Number	Rated Voltage (Volts AC)	Voltage Range (Volts AC)	Input Power (Watts)	Frequency (Hertz)	Rated Speed (RPM)	Max Airflow (CFM)	Noise Level (dBA)	Max Static Pressure ("H <sub>2</sub> O)
OA180AP-11-1*B1869K	115	100 ~ 130	80	50 / 60	3250	380	63	0.76
OA180AP-22-1*B1869K	230	200 ~ 255	80	50 / 60	3250	380	63	0.76

\*Insert "T" for Terminal or "W" for Lead Wire  
\*60 Hz Values shown in table